



# WELDING CONSUMABLES

CATALOG | C1.10







# RED MAX<sup>®</sup> Stainless Steel MIG Welding Wire



Simplify the challenges of welding stainless with RED MAX<sup>®</sup> stainless MIG wires. Consistent wire feeding and arc placement delivers less contact tip wear than leading competitive wires.

Less downtime; increased productivity. That adds up to improved production performance.

Learn more at [lincolnelectric.com/RedMaxWJ](http://lincolnelectric.com/RedMaxWJ)



# TABLE OF CONTENTS

STICK ELECTRODES .....	A (1-39)
MIG & TIG .....	B (1-43)
METAL-CORED .....	C (1-22)
FLUX-CORED .....	D (1-118)
SUBMERGED ARC .....	E (1-52)
STAINLESS .....	F (1-146)
NICKEL .....	G (1-28)
HARDFACING .....	H (1-87)
ALUMINUM & CAST IRON .....	I (1-16)
PIPELINER® .....	J (1-27)
(Lot Controlled)	
POWER GENERATION & NUCLEAR... K	(1-42)
PACKAGING .....	L (1-16)
APPENDIX .....	M (1-44)

Welding Consumables..... 1-9  
 Introduction..... 10  
 Q Lot Certifications..... 11  
 En Certifications..... 12  
 Catalog User Guide..... 13  
 Disclaimers..... 14

## STICK

### Stick (SMAW) Electrode

#### Mild Steel, Cellulosic

Fleetweld® 5P.....A-1  
 Fleetweld® 5P+.....A-2  
 Fleetweld® 35.....A-3  
 Fleetweld® 180.....A-4  
 Murex® 6010.....A-5  
 Murex® 6011C.....A-6

#### Mild Steel, Rutile

Fleetweld® 22.....A-7  
 Fleetweld® 37.....A-8  
 Fleetweld® 47.....A-9  
 Murex® 6013D.....A-10  
 Murex® 7014.....A-11

#### Mild Steel, High Deposition

Jetweld® 1.....A-12  
 Murex® 7024.....A-13

#### Mild Steel, Low Hydrogen

Excalibur® 7018 MR®.....A-14  
 Excalibur® 7018-1 MR®.....A-15  
 Excalibur® 7028.....A-16  
 Jetweld® LH-70.....A-17  
 Jet-LH® 78 MR®.....A-18  
 Lincoln® 7018 AC.....A-19  
 Millennium Arc® 7018-1.....A-20  
 Murex® B7018 MR™.....A-21  
 Murex® 7018 MR®.....A-22

#### Low Alloy, Cellulosic, Pipe

Shield-Arc® HYP+.....A-23  
 Shield-Arc® 85.....A-24  
 Shield-Arc® 70+.....A-25  
 Shield-Arc® 90.....A-26

#### Low Alloy, Low Hydrogen

Excalibur® 7018-A1 MR®.....A-27  
 Excalibur® 8018-B2 MR®.....A-28  
 Excalibur® 8018-C1 MR®.....A-29

Excalibur® 8018-C3 MR®.....A-30  
 Excalibur® 9018-B3 MR®.....A-31  
 Excalibur® 9018M MR®.....A-32  
 Excalibur® 10018-D2 MR®.....A-33  
 Excalibur® 11018M MR®.....A-34  
 Chromet® 5.....A-35  
 Chromet® 9.....A-36  
 Chromet® 9-B9.....A-37  
 Chromet® 9Mv-N.....A-38  
 E9018-D1.....A-39

## MIG & TIG

### MIG (GMAW) Wire

#### Mild Steel, Non-Copper Coated

SuperGlide® S3.....B-1  
 SuperGlide® S6.....B-3

#### Mild Steel, Copper Coated

SuperArc® L-50®.....B-5  
 SuperArc® L-52®.....B-7  
 SuperArc® L-56®.....B-9  
 SuperArc® L-59®.....B-11  
 SuperArc® G4Si1.....B-13  
 Murematic® S3.....B-15  
 Murematic® S4+.....B-16  
 Murematic® S6.....B-17

#### Low Alloy Steel

1CrMo.....B-18  
 2CrMo.....B-19  
 ER90S-B3.....B-20  
 Techalloy® 4130.....B-21

#### Low Alloy, Copper Coated

SuperArc® LA-75™.....B-22  
 SuperArc® LA-90™.....B-24  
 SuperArc® LA-100™.....B-26  
 SuperArc® AK-10®.....B-28

#### Copper Alloys

SuperGlaze™ SiBR.....B-30

### TIG (GTAW) Cut Length

#### Low Alloy Steel

2Ni.....B-31  
 5CrMo.....B-32  
 9CrMoV-N.....B-33  
 Lincoln® AK-10®.....B-34



Lincoln® ER80S-B2..... B-35  
 Lincoln® ER80S-D2..... B-36  
 Lincoln® ER80S-Ni1..... B-37  
 Lincoln® ER90S-B3..... B-38  
 Lincoln® LA-84..... B-39  
 Techalloy® 4130..... B-40

**Mild Steel, Copper Coated**

Lincoln® ER70S-2..... B-41  
 Lincoln® ER70S-6..... B-42

## METAL-CORED

### *GMAW-C Wire*

**Mild Steel**

Metalshield® MC®-70 XLS™..... C-1  
 Metalshield® Clarity™ MC®-707..... C-3  
 Metalshield® MC-6®..... C-5  
 Metalshield® MC®-706..... C-7  
 Metalshield® MC®-706 Buy America..... C-9  
 Metalshield® MC-710XL®..... C-11  
 Metalshield® Z®..... C-13

**Low Alloy**

Metalshield® MC®-80 XLS™..... C-15  
 Metalshield® MC®-90..... C-17  
 Metalshield® MC®-110..... C-19  
 Metalshield® MC®-120..... C-21

## FLUX-CORED

### *Self-Shielded (FCAW-S) Wire*

**Mild Steel, Flat and Horizontal**

Innershield® NR®-5..... D-1  
 Innershield® NR®-131..... D-2  
 Innershield® NR®-305..... D-3  
 Innershield® NR®-311..... D-4  
 Innershield® NS-3M..... D-5

**Low Alloy, Flat and Horizontal**

Innershield® NR®-311 Ni..... D-6

**Mild Steel, All Position**

Innershield® NR®-152..... D-7  
 Innershield® NR®-203-MP..... D-8  
 Innershield® NR®-211-MP..... D-9  
 Innershield® NR®-232..... D-11  
 Innershield® NR®-232-H..... D-13  
 Innershield® NR®-233..... D-15

**Low Alloy, All Position**

Innershield® NR®-203 Nickel (1%)..... D-17  
 Innershield® NR®-203 Ni C Plus-H..... D-18  
 Innershield® NR®-207..... D-19  
 Innershield® NR®-208-H..... D-20  
 Innershield® NR®-212..... D-21  
 Innershield® NR®-440Ni2..... D-23  
 Innershield® NR®-555..... D-25

### *Gas-Shielded (FCAW-G) Wire*

**Mild Steel, All Position**

UltraCore® 360™ C71..... D-27  
 UltraCore® 360™ M71..... D-29  
 UltraCore® 71A75 Dual..... D-31  
 UltraCore® 71A85..... D-33  
 UltraCore® 71C..... D-35  
 UltraCore® 712C..... D-37  
 UltraCore® 712C-H Plus..... D-39  
 UltraCore® 712A80..... D-41  
 UltraCore® 712A80-H..... D-43  
 UltraCore® 712A80-H Plus..... D-45  
 UltraCore® Clarity™ C71 LE..... D-47  
 UltraCore® Clarity™ M71 LE..... D-49  
 UltraCore® HD-C..... D-51  
 UltraCore® HD-M..... D-53  
 UltraCore® HD-12C..... D-55  
 UltraCore® HD-12M..... D-57  
 UltraCore® HD Marine..... D-59  
 Outershield® 71M..... D-61  
 Outershield® 71 Elite..... D-63  
 Outershield® 71 Elite Supreme..... D-65

**Mild Steel, Flat and Horizontal**

UltraCore® 70C..... D-67  
 UltraCore® 70M..... D-69  
 UltraCore® 75C..... D-71  
 UltraCore® XP70..... D-73  
 Outershield® 70..... D-75  
 Outershield® XLH-70..... D-77

**Low Alloy, All Position**

UltraCore® 81Ni1A75-H..... D-79  
 UltraCore® 81Ni1C-H..... D-81  
 UltraCore® 81Ni1C-H Plus..... D-83  
 UltraCore® 81Ni1M-H Plus..... D-85  
 UltraCore® 81Ni2A75-H..... D-87  
 UltraCore® 81Ni2C-H..... D-89  
 UltraCore® 81K2A75-H..... D-91

UltraCore® 81K2C-H.....D-93  
 UltraCore® 81K2C-H Plus.....D-95  
 UltraCore® 81K2M-H Plus.....D-97  
 UltraCore® 91K2C-H Plus.....D-99  
 UltraCore® 91K2M-H Plus.....D-101  
 UltraCore® 101K3M-H Plus.....D-103  
 UltraCore® 111K3C-H Plus.....D-105  
 UltraCore® 111K3M-H Plus.....D-107  
 UltraCore® 121K3M-H Plus.....D-109  
 Cormet® 1.....D-111  
 Cormet® 2.....D-112  
 Cormet® 5.....D-113  
 Supercore® F91.....D-114

**Low Alloy, Flat and Horizontal**

UltraCore® 80Ni1C.....D-115  
 UltraCore® 80Ni1M.....D-117

# SUBMERGED ARC

## Flux

**700 Series Active Flux**

Lincolnweld® 760®.....E-1  
 Lincolnweld® 761®.....E-2  
 Lincolnweld® 780®.....E-3  
 Lincolnweld® 781™.....E-4

**800 Series Neutral Flux**

Lincolnweld® 822™.....E-5  
 Lincolnweld® 842-H™.....E-6  
 Lincolnweld® 860®.....E-7  
 Lincolnweld® 865™.....E-8  
 Lincolnweld® 880™.....E-9  
 Lincolnweld® 880M®.....E-10  
 Lincolnweld® 882™.....E-11  
 Lincolnweld® 888™.....E-12  
 Lincolnweld® 8500™.....E-13  
 Lincolnweld® MIL800-H™.....E-14  
 Lincolnweld® 812-SRC™.....E-15

## Special Neutral Flux

Lincolnweld® 960®.....E-16  
 Lincolnweld® 980™.....E-17  
 Lincolnweld® WTX™.....E-18  
 Lincolnweld® WTX™-TR.....E-19  
 LA490.....E-20

**Flux for Seam Welding of Pipe**

Lincolnweld® 761-Pipe™.....E-21

Lincolnweld® P223™.....E-22  
 Lincolnweld® LPX80N™.....E-23  
 Lincolnweld® SPX80™.....E-24  
 Lincolnweld® SPX80N™.....E-25  
 Lincolnweld® 995N™.....E-26

**High Performance/Alloy Flux**

Lincolnweld® A-XXX10™.....E-27  
 Lincolnweld® MIL800-HPNi™.....E-28

## Solid Wire

**Mild Steel Solid Electrode**

Lincolnweld® L-50®.....E-29  
 Lincolnweld® L-56®.....E-30  
 Lincolnweld® L-60.....E-31  
 Lincolnweld® L-61®.....E-32  
 Lincolnweld® L-53.....E-33  
 Lincolnweld® LA-71.....E-33

**Low Alloy Solid Electrode**

Lincolnweld® AK-10™.....E-34  
 Lincolnweld® L-70.....E-35  
 Lincolnweld® LA-75.....E-35  
 Lincolnweld® LA-81.....E-36  
 Lincolnweld® LA-84.....E-37  
 Lincolnweld® LA-85.....E-38  
 Lincolnweld® LA-90.....E-39  
 Lincolnweld® LA-92.....E-40  
 Lincolnweld® LA-93.....E-41  
 Lincolnweld® LA-100.....E-42  
 Techalloy® 4130.....E-43

## Cored Wire

**Mild Steel**

Lincolnweld® LC-72.....E-44

**Low Alloy**

Lincolnweld® LAC-B2.....E-45  
 Lincolnweld® LAC-Ni2.....E-45  
 Lincolnweld® LAC-690.....E-46  
 9CrMoV-N.....E-47

## Non-Copper Coated Submerged Arc (SAW) Electrode

**Mild Steel Solid Electrode**

Lincolnweld® Emergence™ 61.....E-48  
 Lincolnweld® Emergence™ 73.....E-49

**Low Alloy Solid Electrode**

Lincolnweld® Emergence™ 70.....E-50  
 Lincolnweld® Emergence™ 81.....E-51  
 Lincolnweld® Emergence™ 90.....E-52

# STAINLESS

## Stick Electrode

Excalibur® 308/308L-15 .....	F-1
Excaliburv 308L-16 .....	F-2
Excalibur® 308/308H-16 .....	F-3
Excalibur® 308/308L-17 .....	F-4
Excalibur® 309/309L-15 .....	F-5
Excalibur® 309/309L-16 .....	F-6
Excalibur® 309/309L-17 .....	F-7
Excalibur® 310-16 .....	F-8
Excalibur® 312-16 .....	F-9
Excalibur® 316/316L-15 .....	F-10
Excalibur® 316/316L-16 .....	F-11
Excalibur® 316/316L-17 .....	F-12
Excalibur® 320LR-16 .....	F-13
Excalibur® 330-16 .....	F-14
Excalibur® 347-16 .....	F-15
Excalibur® 385-16 .....	F-16
Excalibur® 410-16 .....	F-17
Excalibur® 410NiMo-16 .....	F-18
Excalibur® 630-16 .....	F-19
Excalibur® 2209-16 .....	F-20
Excalibur® 2594-16 .....	F-21
E16.8.2-15 .....	F-22
Supermet™ 16.8.2 .....	F-23
Thermet™ 22H .....	F-24
Thermet™ 25.35Nb .....	F-25
Thermet™ 35.45.Nb .....	F-26
Thermet™ 800Nb .....	F-27
Thermet™ HP40Nb .....	F-28
Thermet™ HP50WCO .....	F-29
Ultramet® 308LCF .....	F-30
Ultramet® 316LCF .....	F-31
UltraMet B™ 316 NF .....	F-32

## MIG Wire

Blue Max® MIG 307 MOD .....	F-33
Blue Max® MIG 308H .....	F-34
Blue Max® MIG 308LSi .....	F-35
Blue Max® MIG 308L .....	F-37
Blue Max® MIG 308LCF .....	F-38
Blue Max® MIG 309LSi .....	F-39
Blue Max® MIG 309L .....	F-41
Blue Max® MIG 309LMO_MOD .....	F-42
Blue Max® MIG 310 .....	F-43
Blue Max® MIG 312 .....	F-44
Blue Max® MIG 316L .....	F-45
Blue Max® MIG 316LCF .....	F-46

Blue Max® MIG 316LSi .....	F-47
Blue Max® MIG 317L .....	F-49
Blue Max® MIG 320LR .....	F-50
Blue Max® MIG 330 .....	F-51
Blue Max® MIG 347 .....	F-52
Blue Max® MIG 385 .....	F-53
Blue Max® MIG 409Nb .....	F-54
Blue Max® MIG 410 .....	F-55
Blue Max® MIG 410NiMo .....	F-56
Blue Max® MIG 420 .....	F-57
Blue Max® MIG 630 .....	F-58
Blue Max® MIG 2209 .....	F-59
Blue Max® MIG 2594 .....	F-60
Lincoln® Red Max™ 308LSi .....	F-61
Lincoln® Red Max™ 309LSi .....	F-63
Lincoln® Red Max™ 316LSi .....	F-65
Lincoln® Red Max™ 307_MOD .....	F-67
Murex® 308LSi .....	F-69
Murex® 309LSi .....	F-70
Murex® 316LSi .....	F-71

## Flux-Cored (FCAW-G) Wire

UltraCore® 308L .....	F-72
UltraCore® 308L P .....	F-74
UltraCore® 309L .....	F-76
UltraCore® 309L P .....	F-78
UltraCore® FC 316L .....	F-80
UltraCore® 316L P .....	F-82
Supercore™ 308LCF .....	F-84
Supercore™ 316LCF .....	F-85
Supercore™ 347 .....	F-86
Supercore™ 2205P .....	F-87
Supercore™ 2507 .....	F-89
Supercore™ 2507P .....	F-90
Supercore™ 308HP .....	F-91
Supercore™ 317LP .....	F-92
Supercore™ 16.8.2P .....	F-93
Supercore™ Z100XP .....	F-94

## Submerged Arc Wire

Lincolnweld® 308/308L .....	F-95
Lincolnweld® 308/308H .....	F-96
Lincolnweld® 308/308LCF .....	F-97
Lincolnweld® 309 LMO_MOD .....	F-98
Lincolnweld® 309/309L .....	F-99
Lincolnweld® 310 .....	F-101
Lincolnweld® 316/316LCF .....	F-102
Lincolnweld® 316/316L .....	F-103
Lincolnweld® 317/317L .....	F-105



Lincolnweld® 320LR ..... F-106  
 Lincolnweld® 347 ..... F-107  
 Lincolnweld® 385 ..... F-108  
 Lincolnweld® 410NiMo ..... F-109  
 Lincolnweld® 630 ..... F-110  
 Lincolnweld® 2209 ..... F-111  
 Lincolnweld® 2594 ..... F-112  
 ER16.8.2 ..... F-113

**Submerged Arc Flux**

Lincolnweld® P2000™ ..... F-114  
 Lincolnweld® P2007™ ..... F-115  
 Lincolnweld® ST-100™ ..... F-116

**TIG Cut Length**

Lincoln® ER308/308H ..... F-117  
 Lincoln® ER308/308L ..... F-118  
 Lincoln® ER308/308LCF ..... F-119  
 Lincoln® ER308Si/308LSi ..... F-120  
 Lincoln® ER309/309L ..... F-122  
 Lincoln® ER309Si/309LSi ..... F-123  
 Lincoln® ER310 ..... F-125  
 Lincoln® ER312 ..... F-126  
 Lincoln® ER316/316L ..... F-127  
 Lincoln® ER316/316LCF ..... F-128  
 Lincoln® ER317/317L ..... F-129  
 Lincoln® ER320LR ..... F-131  
 Lincoln® ER347 ..... F-133  
 Lincoln® ER385 ..... F-134  
 Lincoln® ER409Nb ..... F-135  
 Lincoln® ER410 ..... F-136  
 Lincoln® ER410NiMo ..... F-137  
 Lincoln® ER630 ..... F-138  
 Lincoln® ER2209 ..... F-139  
 Lincoln® ER2594 ..... F-140  
 ER16.8.2 ..... F-141

**Metal-Cored Wire**

PRIMALLOY™ T-409Ti ..... F-142  
 PRIMALLOY™ T-439Ti ..... F-143

**Orbital TIG (GTAW) Wire**

Blue Max® Orbital TIG 308/308L ..... F-144  
 Blue Max® Orbital TIG 309/309L ..... F-145  
 Blue Max® Orbital TIG 316/316L ..... F-146

**NICKEL**

**Stick (SMAW) Electrode**

Tech-Rod® 55 ..... G-1  
 Tech-Rod® 99 ..... G-2  
 Tech-Rod® 112 ..... G-3  
 Tech-Rod® 112LFe ..... G-4  
 Tech-Rod® 117 ..... G-5  
 Tech-Rod® 122 ..... G-6  
 Tech-Rod® 141 ..... G-7  
 Tech-Rod® 182 ..... G-8  
 Tech-Rod® 187 ..... G-9  
 Tech-Rod® 190 ..... G-10  
 Tech-Rod® 276 ..... G-11  
 Tech-Rod® Weld A ..... G-12

**MIG/TIG/SAW Wire**

Techalloy® 55 ..... G-13  
 Techalloy® 99 ..... G-14  
 Techalloy® 208 ..... G-15  
 Techalloy® 276 ..... G-16  
 Techalloy® 413 ..... G-17  
 Techalloy® 418 ..... G-18  
 Techalloy® 606 ..... G-19  
 Techalloy® 617 ..... G-20  
 Techalloy® 622 ..... G-21  
 Techalloy® 625 ..... G-22  
 Techalloy® 686 ..... G-24  
 Techalloy® 718 ..... G-25  
 Techalloy® 825 ..... G-26  
 Techalloy® X ..... G-27

**Flux-Cored (FCAW-G) Wire**

SuperCore® 625P ..... G-28

**HARDFACING**

**Stick (SMAW) Electrode**

**Cobalt**

Weartech® WT-1 SMAW ..... H-1  
 Weartech® WT-6 SMAW ..... H-2  
 Weartech® WT-12 SMAW ..... H-3  
 Weartech® WT-21 SMAW ..... H-4

**Build-Up**

Wearshield® BU ..... H-5

<b>Metal-to-Metal Wear</b>		<b>Metal-to-Metal, Build Up</b>	
Wearshield® MI.....	H-6	Lincore® 32-S.....	H-33
Wearshield® Mangjet®.....	H-7	Lincore® 35-S.....	H-34
<b>Severe Impact</b>		<b>Metal-to-Metal</b>	
Wearshield® 15CrMn.....	H-8	Lincore® 40-S.....	H-35
Wearshield® FROG MANG®.....	H-9	Lincore® 42-S.....	H-36
Wearshield® Super Rail™.....	H-10	<b>Roll Rebuilding, Build Up</b>	
<b>Abrasion and Impact</b>		Lincore® 20.....	H-37
Wearshield® ABR.....	H-11	Lincore® 4130.....	H-38
Wearshield® 44.....	H-12	Lincore® 8620.....	H-39
<b>Metal-to-Earth Wear</b>		<b>Roll Rebuilding, Metal-to-Metal</b>	
Wearshield® ME.....	H-13	Lincore® 410.....	H-40
<b>Severe Abrasion</b>		Lincore® 410NiMo.....	H-41
Wearshield® 60.....	H-14	Lincore® 423L.....	H-42
Weartech® SHS® 9700E.....	H-15	Lincore® 423Cr.....	H-43
<b>Maintenance and Repair</b>		Lincore® 420.....	H-44
Blue Max® 2100.....	H-16	Lincore® 414N.....	H-45
<b>TIG (GTAW) Cut Lengths</b>		Lincore® 423N.....	H-45
<b>Cobalt</b>		Lincore® 965.....	H-46
Weartech® WT-1 TIG.....	H-17	Lincore® 102W.....	H-47
Weartech® WT-6 TIG.....	H-18	Lincore® 102HC.....	H-48
Weartech® WT-12 TIG.....	H-19	<b>Flux-Cored (FCAW-G) Wire</b>	
Weartech® WT-21 TIG.....	H-20	<b>Build-Up</b>	
<b>Nickel</b>		Lincore® BU-G.....	H-49
Weartech® WT-40 TIG.....	H-21	<b>Metal-to-Metal</b>	
Weartech® WT-50 TIG.....	H-22	Lincore® 55-G.....	H-50
Weartech® WT-56 TIG.....	H-23	<b>Flux-Cored (FCAW-S) Wire</b>	
Weartech® WT-60 TIG.....	H-24	<b>Build-Up</b>	
<b>Metal-Cored (GMAW-C) Wire</b>		Lincore® BU.....	H-51
<b>Severe Abrasion</b>		Lincore® 33.....	H-52
Lincore® 57-G.....	H-25	<b>Metal-to-Metal</b>	
Lincore® 60-G.....	H-26	Lincore® 40-O.....	H-53
Lincore® 70-G.....	H-27	Lincore® 55.....	H-54
<b>Cobalt</b>		Lincore® T & D.....	H-55
Weartech® WT-1 GMAW-C.....	H-28	<b>Severe Impact</b>	
Weartech® WT-6 GMAW-C.....	H-29	Lincore® M.....	H-56
Weartech® WT-12 GMAW-C.....	H-30	Lincore® 15CrMn.....	H-57
Weartech® WT-21 GMAW-C.....	H-31	Lincore® FROG MANG®.....	H-58
<b>Metal-Cored Submerged Arc Wire</b>		Lincore® Super Rail™.....	H-59
<b>Build-Up</b>		<b>Abrasion Plus Impact</b>	
Lincore® 30-S.....	H-32	Lincore® 50.....	H-60

**Severe Abrasion**

Lincore® 60-O ..... H-61  
 Lincore® Ultra K ..... H-62  
 Lincore® 65-O ..... H-63  
 Lincore® 70-O ..... H-64  
 Lincore® BCR-O ..... H-65  
 Lincore® BNB-O ..... H-66  
 Lincore® Gatorback-O ..... H-67  
 Lincore® Gatorback-S ..... H-68  
 Lincore® Ultra R ..... H-69  
 Lincore® TiCore ..... H-70  
 Wearthech® SHS® 9800U ..... H-71  
 Wearthech® SHS® 9700U ..... H-72  
 Wearthech® SHS® 9192U ..... H-73  
 Wearthech® SHS® 9500U ..... H-74

**Submerged Arc (SAW) Flux**

**Hardfacing**

Lincolnweld® A-96-S ..... H-75  
 Lincolnweld® H-535™ ..... H-75  
 Lincolnweld® H-560™ ..... H-76

**Neutral Flux**

Lincolnweld® 801° ..... H-77  
 Lincolnweld® 802° ..... H-77

**Hardbanding Cored Wire**

**Severe Abrasion**

Wearthech® Guardian® HB ..... H-78  
 Wearthech® Guardian® CF ..... H-79

**Wire Arc Spray**

**Severe Abrasion**

Wearthech® SHS® 7570W ..... H-80  
 Wearthech® SHS® 8000W ..... H-81  
 Wearthech® SHS® 9172W ..... H-82

**Thermal Spray Powder**

**Severe Abrasion**

Wearthech® SHS® 7574HV ..... H-83  
 Wearthech® SHS® 8000HV ..... H-84  
 Wearthech® SHS® 9172HV ..... H-85

**Plasma Transferred Arc Weld Powder (PTAW)**

**Severe Abrasion**

Wearthech® SHS® 9290P ..... H-86  
 Wearthech® SHS® 9700P ..... H-87

**ALUMINUM & CAST IRON**

**Aluminum**

**MIG Wire**

SuperGlaze® 4043 ..... I-1  
 SuperGlaze® 4047 ..... I-2  
 SuperGlaze® 5183 ..... I-3  
 SuperGlaze® HD 5183 ..... I-4  
 SuperGlaze® 5356 ..... I-5  
 SuperGlaze® HD 5356 ..... I-6  
 SuperGlaze® 5356 TM™ ..... I-7  
 SuperGlaze® HD 5356 TM™ ..... I-8  
 SuperGlaze® 5554 ..... I-9  
 SuperGlaze® 5556 ..... I-10  
 SuperGlaze® HD 5556 ..... I-11

**TIG Cut Length**

SuperGlaze® 4043 ..... I-12  
 SuperGlaze® 5356 ..... I-13

**Cast Iron**

**Stick Electrode**

Ferroweld® ..... I-13

**Additional Information**

Typical Joint Designs ..... I-14  
 Typical Operating Procedures ..... I-15

**PIPELINER®**

**Stick (SMAW) Electrode**

**Mild Steel, Cellulosic**

Pipeliners® 6P+ ..... J-1

**Mild Steel, Low Hydrogen**

Pipeliners® 16P ..... J-2

**Low Alloy, Cellulosic**

Pipeliners® 7P+ ..... J-3  
 Pipeliners® 8P+ ..... J-4  
 Pipeliners® Arc 80 ..... J-5

**Low Alloy, Low Hydrogen**

Pipeliners® 18P ..... J-6  
 Pipeliners® LH-D80 ..... J-7  
 Pipeliners® LH-D90 ..... J-8  
 Pipeliners® LH-D100 ..... J-9  
 Pipeliners® 19P ..... J-10



**MIG (GMAW) Wire**

**Mild and Low Alloy Steel Pipe**

Pipeliner® 70S-6 .....J-11  
 Pipeliner® 70S-G .....J-12  
 Pipeliner® 80S-G .....J-13  
 Pipeliner® 80Ni1 .....J-14

**Flux-Cored Self-Shielded (FCAW-S) Wire**

**Low Alloy, All Position**

Pipeliner® NR®-207+ .....J-15  
 Pipeliner® NR®-208-P .....J-16  
 Pipeliner® NR®-208-XP .....J-17

**Flux-Cored Gas-Shielded (FCAW-G) Wire**

**Low Alloy, All Position**

Pipeliner® 81M .....J-18  
 Pipeliner® 101M .....J-19  
 Pipeliner® 111M .....J-20  
 Pipeliner® G90M .....J-21

**Additional Information**

Pipe Grades .....J-22  
 Electrode Selection Guide .....J-23  
 LH-D80/90/100 Welding Guidelines .....J-25  
 EN and ISO Classifications .....J-25  
 Agency Approvals .....J-27

**POWER GENERATION & NUCLEAR (LOT CONTROLLED)**

**Additional Information**

Q2 Lot Certificates Center Overview .....K-1  
 Nuclear Products / Batch Managed Overview .....K-2

**Stick (SMAW) Electrode**

**Mild Steel**

Excalibur® 7018 MR® N\* .....K-3

**Low Alloy Steel**

Excalibur® 8018-B2 MR® .....K-5  
 Excalibur® 9018-G MR® N .....K-7

**MIG (GMAW) Wire**

**Mild Steel**

SuperArc® L-56° N\* .....K-9

**Low Alloy Steel**

SuperArc® AK-10 .....K-11  
 SuperArc® LA-75\* .....K-13

**Stainless Steel**

Blue Max® MIG 308L N\* .....K-15  
 Blue Max® MIG 309L N\* .....K-17  
 Blue Max® MIG 316L N\* .....K-19  
 Blue Max® LNM 4462 N\* .....K-21

**TIG (GTAW) Cut Lengths**

**Low Alloy Steel**

Lincoln® ER100S-1 .....K-22

**Stainless Steel**

Lincoln® ER308/308L N\* .....K-23  
 Lincoln® ER309/309L N\* .....K-24  
 Blue Max® LNT 4462 N\* .....K-25

**TIG (GTAW) Cut Lengths - Orbital**

**Mild Steel**

SuperArc® Orbital TIG L-52 N\* .....K-26  
 SuperArc® Orbital TIG L-56° N\* .....K-27  
 Blue Max® Orbital TIG 308/308L N\* .....K-28  
 Blue Max® Orbital TIG 309/309L N\* .....K-29  
 Blue Max® Orbital TIG 316/316L N\* .....K-30

**Low Alloy Steel**

SuperArc® Orbital TIG AK-10 .....K-31  
 SuperArc® Orbital TIG ER80S-B2 .....K-32  
 SuperArc® Orbital TIG ER90S-B3 .....K-33

**Submerged Arc (SAW) Flux & Wire Combinations**

**Low Alloy Steel**

Lincolnweld® MIL800-H &  
 Lincolnweld® LA-84 .....K-34  
 Lincolnweld® MIL-800-H &  
 Lincolnweld® LA-100 .....K-35

**Stainless Steel**

Lincolnweld® P2007™ &  
 Lincolnweld® 308/308L .....K-36  
 Lincolnweld® P2007™ &  
 Lincolnweld® 309/309L .....K-37  
 Lincolnweld® P2007™ &  
 Lincolnweld® 316/316L .....K-38

**Flux-Cored (FCAW-G) Wire**

**Mild Steel**

UltraCore® 71A85\* .....K-39  
 UltraCore® SR-12H .....K-41

*\*These products are available as Batched Managed Inventory*

# PACKAGING

## Options

Tubes, Cans & Cartons .....	L-1
Reels & Stem .....	L-3
Spools .....	L-5
Coils, Boxes & Bags .....	L-7
Drums & Pails .....	L-9

## Storage and Handling

Stick Electrode .....	L-11
Stainless Steel & Nickel .....	L-12
Metal-Cored & Flux-Cored Wire .....	L-13
Submerged Arc Flux & Wire .....	L-14
Accu-Pak® Box .....	L-15

# APPENDIX

## *AWS Classification System*

Stick (SMAW) .....	M-1
MIG (GMAW), TIG (GTAW) & Metal-Cored (GMAW-C) .....	M-2
Flux-Cored (FCAW) .....	M-3
Submerged Arc (SAW) Flux & Electrode .....	M-6

## *General Information*

### Stick Electrode

Types of Coating & Current .....	M-8
ASME Boiler & Pressure Vessel Code .....	M-9

### Submerged Arc

Flux Types & General Characteristics .....	M-10
Selecting Flux/Wire Combinations .....	M-11

### Innershield®

Wire Selection Guide .....	M-13
----------------------------	------

### Hardfacing

Cross Checking .....	M-15
----------------------	------

<i>Agency Approvals</i> .....	M-16
-------------------------------	------

<i>Safety Guidelines</i> .....	M-37
--------------------------------	------

Lincoln Electric is focused on helping companies make their welding operations more effective, more efficient and more profitable. We are dedicated to two equally important goals: exceptional quality and exceptional service. Our field support team — with hundreds of field sales engineers and thousands of knowledgeable and responsive Lincoln Electric distributors in countries all over the world — is the largest in the industry. Lincoln Electric’s innovative thinking, fresh approach to design and a quality-first attitude presents our customers with worldwide strength and support.

## INDUSTRY-LEADING CONSISTENCY

Consistency is critical to the strength and appearance of every weld. Lincoln Electric quality starts with superior materials – incoming raw steel slated for use in consumables is analyzed for chemical composition, checking more than 20 different elements before being cleared for production. The result is a line of weld consumables that are reliably uniform in diameter and chemical composition. In fact, Lincoln Electric standards are considerably more restrictive than AWS requirements.



## BETTER MANUFACTURING SYSTEMS

Lincoln Electric employs the most technically advanced and carefully monitored manufacturing and quality control systems in the welding industry. The result is a line of weld consumables that are reliably uniform.

## INDUSTRY SOLUTIONS

Lincoln Electric is committed to developing welding solutions that meet the unique needs of our customers, worldwide. Becoming Lincoln Electric’s global partner provides your company with specialized, industry-tested equipment and consumables created to meet industry specific welding requirements. Whether your company manufactures pipelines, wind towers or offshore oil rigs, choosing Lincoln Electric ensures maximum productivity, quality and profitability for our customers.

## THE SYMBOL OF DEPENDABILITY

Our stick electrodes have been the number one choice of fabricators for over a century. They are easily identified by three dots, which are a symbol of quality, consistency, and unparalleled welding expertise. When only the best will do, there is no substitute for a Lincoln Electric stick electrode.



# Q LOT CERTIFICATIONS



## CERTIFICATION TO MEET YOUR NEEDS

Lincoln Electric offers three levels of Q Lot Certification. While each is indicative of a unique set of tests, traceabilities and records, all Q Lot Certs share a common heritage grounded in chemical composition control and Lincoln Electric's Six Sigma driven production system. No matter which Q Lot Cert you require – from our standard Q1 Lot® Cert to our comprehensive and exacting Q3 Lot® Cert, you get the peace-of-mind that comes from knowing that you can count on the performance of your welding consumables.

	Q1	Q2	Q3
Lincoln Electric standard ISO manufacturing system	▪	▪	▪
Certificates of conformance	▪	▪	▪
Lincoln Electric Q Lot number on product meets AWS A5.01 lot definition requirements	▪	▪	▪
Link Q Lot number to certificate of conformance	▪	▪	▪
Traceable to Lincoln manufacturing date, shift and operator	▪	▪	▪
Recorded flux/mix chemistry	▪	▪	▪
<i>Items below represent additional agency requirements for testing and traceability</i>			
Independent verification of records		▪	▪
Recorded steel chemistry		▪	▪
Lot control number per a specification (ASME code, for instance)		▪	▪
Testing per specification (when required)		▪	▪
Independent verification of all tests		▪	▪
Test results traceable to Lincoln archived records		▪	▪
Certification with test results issued to customer			▪
Certification with test results traceable from Lincoln Electric to customer			▪
Lincoln Electric keeps records on file			▪
Certification issued to customer			▪

Lincoln Electric's Quality System is derived from controlled chemical composition of steel. Our Q Lot System is comprised of three comprehensive levels:

**Q1 LOT®** – Lincoln Electric's standard manufacturing and Quality Assurance System. We start by evaluating the raw materials, analyzing the nose and tail end of each green rod coil for chemical composition ensuring it meets Lincoln's stringent requirements. Our tight tolerances go beyond AWS requirements to ensure consistency in product chemistry, mechanical properties and operation. Providing traceability to the date of manufacture, operator, line and shift.

*Examples:* Standard commercial products. Products have and AWS certificate of conformance.

**Q2 LOT®** – Comprised of Q1 Lot®, plus archived lot controlled records of in-process testing and manufacturing, as well as actual and deposit composition test results of the finished product. Providing traceability to the date of manufacture, operator, line and shift.

*Examples:* Stainless, Nickel, Pipeliner® and all Batch Managed Inventory. Products have Certified Material Test Reports (CMTR's, 3.1)

**Q3 LOT®** – Comprised of Q2 Lot®, plus special testing requirements and archived records for a specific shipment or customer. Product is made to order per customer's requirements.

*Examples:* Military and Nuclear certification. Products have Certified Material Test Reports (CMTR's, 3.1)

# EN CERTIFICATIONS

EN 10204 INSPECTION DOCUMENTS	TESTING LEVELS PER AWS A5.01 FILLER METAL PROCUREMENT GUIDELINES	EXAMPLES OF LINCOLN ELECTRIC OPTIONS
<p><b>Type 2.1</b> States "Products are in compliance with requirements of the order (WITHOUT any test results).</p>	<p><b>Schedule F</b> The level of testing shall be the manufacturer's standard. A statement, "the product supplied will meet the requirements of the applicable AWS standard, when tested in accordance with that standard" and a summary of the typical properties of the material, when tested in that manner, shall be supplied upon written request.</p>	<p>Lincoln Electric "3 year" Certificate of Conformance applicable to a Q1 Lot®.</p>
<p><b>Type 2.2</b> States "Products are in compliance with requirements of the order (includes non-specific test results – NOT ACTUALS from the lot in question).</p>	<p><b>Schedule G</b> Test results shall be supplied from any production run of the product made within the twelve months preceding the date of the purchase order. This shall include the results of all tests prescribed for that classification in the AWS standard.</p>	<p>Lincoln Electric "1 year" Certificate of Conformance applicable to a Q1 Lot®.</p>
<p><b>Type 3.1</b> States "Products are in compliance with requirements of the order and includes ACTUAL test results for some requirements, but not all.</p>	<p><b>Schedule H</b> Chemical analysis of each lot shipped shall be supplied by the manufacturer. The analysis shall include those elements prescribed for that classification in the AWS standard."</p>	<p>Lincoln Electric "Q1 with Schedule H" Certificate of Actual Results on each S4 lot of SAW wire. Lincoln Electric "Q2" Certified Material Test Reports for stainless products.</p>
	<p><b>Schedule I</b> Actual results of the tests called for in Table 2 of AWS A5.01 shall be supplied by the manufacturer for each lot shipped. These tests represent a consensus of those frequently requested for consumables certification; however, they do not necessarily include all tests required for Schedule J. The tests shall be performed as prescribed for that classification in the AWS standard.</p>	<p>Lincoln Electric "Q2" Certified Material Test Reports for products such as Pipeliner® brand.</p>
	<p><b>Schedule J</b> Actual results of all of the tests prescribed for that classification in the AWS standard shall be supplied by the manufacturer for each lot shipped."</p>	<p>Lincoln Electric "Q2" Certified Material Test Reports for stainless solid wires such as BlueMax® MIG, Lincolnweld® stainless subarc wires, and Lincoln® stainless cut length products.</p>
	<p><b>Schedule K</b> In addition to, or in place of, any of the tests called for in the AWS standard, the purchaser may require other tests (such as testing after a specified heat treatment). In all such cases, the purchaser shall identify on the purchase order the specific tests that are to be conducted, the procedures to be followed, the requirements that shall be met and the results to be reported by the manufacturer.</p>	<p>Lincoln Electric "Q3" Certified Material Test Reports to specific customer requirements. Lincoln Electric "Q1 with Schedule K" Certificate of Actual Results for composition on each lot of SAW flux.</p>

# CATALOG USER GUIDE

**1 CATALOG SECTION** — C C

**2 BRAND NAME** — PIPELINER® MIG (GMAW) WIRE

**3 PRODUCT CATEGORY SECTION** — **PIPELINER® 70S-G**

**4 CLASSIFICATION** — Mild & Low Alloy Steel Pipe • AWS ER70S-G

**5 KEY FEATURES** —

- Root pass capability up to API Grade X100 and hot, fill and cap pass up to X70 grade pipe
- Good back bead shape on STT® root passes
- Q2 Lot® - Certificates showing actual wire composition and actual mechanical properties available online
- Low silicon level for minimal clean-up
- ProTech® packaging system

**6 CONFORMANCES** —

**AWS A5.18/A5.18M: 2005** ER70S-G  
**ASME SFA-A5.18:** ER70S-G  
**EN ISO 14341-B:** G 49A Z C SZ

**7 TYPICAL APPLICATIONS** —

- Root pass welding of up to X100 grade pipe
- Hot, fill and cap pass welding of up to X70 grade pipe

**8 WELDING POSITIONS** — **WELDING POSITIONS**  
All

**9 SHIELDING GAS** — **SHIELDING GAS**  
100% CO<sub>2</sub>  
75-95% Argon / Balance CO<sub>2</sub>  
Flow Rate: 30 - 50 CFH

**10 DIAMETERS & PACKAGING** — **DIAMETERS / PACKAGING**

Diameter in (mm)	10 lb (4.5 kg) Plastic Spool (Vacuum Sealed Foil Bag)	25 lb (11.3 kg) Plastic Spool (Vacuum Sealed Foil Bag)
0.045 (1.1)	ED030904	ED030905

**11 MECHANICAL PROPERTIES** — **MECHANICAL PROPERTIES<sup>(1)</sup> – As Required per AWS A5.18/A5.18M: 2005**

	Yield Strength <sup>(2)</sup> MPa (ksi)	Tensile Strength MPa (ksi)	Elongation %	Charpy V-Notch J (ft-lbf) @ -29°C (-20°F)
<b>Requirements - AWS ER70S-G As-Welded with 100% CO<sub>2</sub></b>	400 (58) min.	485 (70) min.	22 min.	Not Specified
<b>Typical Results<sup>(3)</sup> As-Welded with 100% CO<sub>2</sub></b>	405-425 (59-62)	510-40 (74-78)	24-26	54-81 (40-60)

**12 WIRE/DEPOSIT/CHEMICAL COMPOSITION** — **WIRE COMPOSITION – As Required per AWS A5.18/A5.18M: 2005**

	%C	%Mn	%Si	%S	%P	%Cu
<b>Requirements - AWS ER70S-G</b>	Not Specified					
<b>Typical Results<sup>(3)</sup></b>	0.05-0.15	0.80-1.40	0.30-0.60	≤0.02	≤0.02	≤0.02

**13 TYPICAL OPERATING PROCEDURES** — **TYPICAL OPERATING PROCEDURES**

Diameter, Polarity	CTWD <sup>(4)</sup> mm (in)	Wire Feed Speed m/min (in/min)	Voltage (volts)	Approx. Current (amps)	Melt-Off Rate kg/hr (lb/hr)
<b>1.1 mm (0.045 in), DC+</b>	12-19 (1/2-3/4)	3.2-12.7 (125-500)	19-30	145-340	1.5-6.0 (3.4-13.2)

<sup>(1)</sup>Typical all weld metal. <sup>(2)</sup>Measured with 0.25 offset. <sup>(3)</sup>See test results disclaimer on pg. 18. <sup>(4)</sup>CTWD (Contact Tip to Work Distance). Subtract 1/4 in. (6.4 mm) to calculate Electrical Stickout.

394 | www.lincolnelectric.com

- 1 Refer to the top of each page for a reference to the consumable category.
- 2 The name of each product appears in the top left or right corner of each page.
- 3 Each consumable section of the catalog has subcategories to further define each product.
- 4 AWS or EN classification.
- 5 Top features of each product.
- 6 Every specification and conformance to which the product is tested.
- 7 List of where customers typically use product.
- 8 Flat and Horizontal or All Position capability.
- 9 Recommended shielding gas in order of performance and (where applicable).
- 10 Diameters and packaging available for each product (manufactured to the unit of measurement listed first).
- 11 Details the AWS mechanical property requirements and typical test results for each product's weld deposit.
- 12 Details the AWS chemical composition content requirements and typical wire composition or deposit composition results.
- 13 Recommended operating ranges and resulting melt-off and/or deposition rates for each product diameter.

# DISCLAIMERS

## TEST RESULTS

Test results for mechanical properties, deposit or electrode composition and diffusible hydrogen levels were obtained from a weld produced and tested according to prescribed standards, and should not be assumed to be the expected results in a particular application or weldment. Actual results will vary depending on many factors, including, but not limited to, weld procedure, plate chemistry and temperature, weldment design and fabrication methods. Users are cautioned to confirm by qualification testing, or other appropriate means, the suitability of any welding consumable and procedure before use in the intended application.

## CUSTOMER ASSISTANCE POLICY

The Lincoln Electric Company is manufacturing and selling high quality welding equipment, consumables, and cutting equipment. Our challenge is to meet the needs of our customers and to exceed their expectations. On occasion, purchasers may ask Lincoln Electric for information or advice about their use of our products. Our employees respond to inquiries to the best of their ability based on information provided to them by the customers and the knowledge they may have concerning the application. Our employees, however, are not in a position to verify the information provided or to evaluate the engineering requirements for the particular weldment. Accordingly, Lincoln Electric does not warrant or guarantee or assume any liability with respect to such information or advice. Moreover, the provision of such information or advice does not create, expand, or alter any warranty on our products. Any express or implied warranty that might arise from the information or advice, including any implied warranty of merchantability or any warranty of fitness for any customers' particular purpose is specifically disclaimed.

Lincoln Electric is a responsive manufacturer, but the selection and use of specific products sold by Lincoln Electric is solely within the control of, and remains the sole responsibility of the customer. Many variables beyond the control of Lincoln Electric affect the results obtained in applying these types of fabrication methods and service requirements.

Subject to Change – This information is accurate to the best of our knowledge at the time of printing. Please refer to [www.lincolnelectric.com](http://www.lincolnelectric.com) for any updated information.

## IMPORTANT INFORMATION ON OUR WEBSITE

### Consumable AWS Certificates:

<http://www.lincolnelectric.com/LEExtranet/MyLincolnCerts/site/default.aspx>

### D1.8 Certificate Center:

<http://www.lincolnelectric.com/LEExtranet/MyLincolnCerts/site/awsd.aspx>

### Material Safety Data Sheets (MSDS):

<http://www.lincolnelectric.com/en-us/support/msds/Pages/msds.aspx>

### ANSI Z49.1, E205 Safety Booklet:

<http://www.lincolnelectric.com/en-us/education-center/welding-safety/documents/e205.pdf>

### More Welding Safety Materials can be found at:

<http://www.lincolnelectric.com/en-us/education-center/welding-safety/Pages/welding-safety.aspx>





*Stick (SMAW) Electrode*

**Mild Steel, Cellulosic**

Fleetweld® 5P® .....	A-1
Fleetweld® 5P+® .....	A-2
Fleetweld® 35.....	A-3
Fleetweld® 180.....	A-4
Murex® 6010 .....	A-5
Murex® 6011C.....	A-6

**Mild Steel, Rutile**

Fleetweld® 22.....	A-7
Fleetweld® 37.....	A-8
Fleetweld® 47.....	A-9
Murex® 6013D .....	A-10
Murex® 7014 .....	A-11

**Mild Steel, High Deposition**

Jetweld® 1 .....	A-12
Murex® 7024 .....	A-13

**Mild Steel, Low Hydrogen**

Excalibur® 7018 MR® .....	A-14
Excalibur® 7018-1 MR® .....	A-15
Excalibur® 7028.....	A-16
Jetweld® LH-70.....	A-17
Jet-LH® 78 MR® .....	A-18
Lincoln® 7018 AC.....	A-19
Millennium Arc® 7018-1 .....	A-20
Murex® B7018 MR® .....	A-21
Murex® 7018 MR® .....	A-22

**Low Alloy, Cellulosic, Pipe**

Shield-Arc® HYP+ .....	A-23
Shield-Arc® 85.....	A-24
Shield-Arc® 70+ .....	A-25
Shield-Arc® 90.....	A-26

**Low Alloy, Low Hydrogen**

Excalibur® 7018-A1 MR® .....	A-27
Excalibur® 8018-B2 MR® .....	A-28
Excalibur® 8018-C1 MR® .....	A-29
Excalibur® 8018-C3 MR® .....	A-30
Excalibur® 9018-B3 MR® .....	A-31
Excalibur® 9018M MR® .....	A-32
Excalibur® 10018-D2 MR® .....	A-33
Excalibur® 11018M MR® .....	A-34
Chromet® 5.....	A-35
Chromet® 9.....	A-36
Chromet® 9-B9.....	A-37
Chromet® 9MV-N.....	A-38
E9018-D1.....	A-39

# FLEETWELD® 5P®

Mild Steel, Cellulosic ▪ AWS E6010

## KEY FEATURES

- Deep arc penetration
- Light slag with minimal arc interference
- Excellent vertical and overhead capability

## TYPICAL APPLICATIONS

- Steel with moderate surface contaminants
- Cross country and in-plant pipe welding
- Square edge butt welds
- Welding on galvanized and specially coated steels

## CONFORMANCES

AWS A5: E6010  
 ABS: E6010  
 CWB/CSA: E4310  
 Lloyd's Register: 3M

## WELDING POSITIONS

All

## DIAMETERS / PACKAGING

Diameter in (mm)	Length in (mm)	5 lb (2.3 kg) Plastic Tube 20 lb (9.1 kg) Master Carton*	10 lb (4.5 kg) Easy Open Can 30 lb (13.6 kg) Master Carton	50 lb (22.7kg) Easy Open Can
3/32 (2.4)	12 (300)	ED033509	ED032561	ED010211
1/8 (3.2)	14 (350)	ED033510	ED032562	ED010203
5/32 (4.0)	14 (350)	ED033511	ED032563	ED010216
3/16 (4.8)	14 (350)			ED010207
7/32 (5.6)	14 (350)			ED010219
1/4 (6.4)	14 (350)			ED010200

\* NOTE: Retail Small Packaging (RSP). All RSP products carry AWS compliance. Unlike the standard products, RSP products have no other agencies approvals.

## MECHANICAL PROPERTIES<sup>(1)</sup> – As Required per AWS A5.1

	Yield Strength <sup>(2)</sup> MPa (ksi)	Tensile Strength MPa (ksi)	Elongation %	Charpy V-Notch J (ft·lbf) @-29°C (-20°F)
Requirements - AWS E6010	330 (48) min	430 (60) min	22 min	27 (20) min
Typical Results <sup>(3)</sup> - As-Welded	420-475 (61-69)	515-570 (75-83)	25-31	41-68 (30-50)

## DEPOSIT COMPOSITION<sup>(1)</sup> – As Required per AWS A5.1

	%C	%Mn	%Si	%P	%S
Requirements - AWS E6010	0.20 max	1.20 max	1.00 max	Not Specified	Not Specified
Typical Results <sup>(3)</sup> - As-Welded	0.09-0.17	0.40-0.63	0.09-0.43	0.005-0.017	0.005-0.014
	%Ni	%Cr	%Mo	%V	
Requirements - AWS E6010	0.30 max	0.20 max	0.30 max	0.08 max	
Typical Results <sup>(3)</sup> - As-Welded	0.01-0.05	0.01-0.05	≤ 0.03	≤ 0.01	

## TYPICAL OPERATING PROCEDURES

Polarity <sup>(4)</sup>	Current (Amps)					
	3/32 in (2.4 mm)	1/8 in (3.2 mm)	5/32 in (4.0 mm)	3/16 in (4.8 mm)	7/32 in (5.6 mm)	1/4 in (6.4 mm)
DC+	40-80	70-130	90-165	140-225	200-275	220-325
DC-	50-85	75-135	100-175	–	–	–

<sup>(1)</sup>Typical all weld metal. <sup>(2)</sup>Measured with 0.2% offset. <sup>(3)</sup>See test results disclaimer <sup>(4)</sup>Preferred polarity is listed first.

# FLEETWELD® 5P+®

Mild Steel, Cellulosic ▪ AWS E6010

## KEY FEATURES

- Standard in the pipe welding industry for root pass
- High operator appeal and control
- Easy slag removal

## TYPICAL APPLICATIONS

- Cross country and in-plant pipe welding
- Steel with moderate surface contaminants
- Repair welding

## CONFORMANCES

<b>AWS A5:</b>	E6010
<b>ABS:</b>	E6010
<b>CWB/CSA:</b>	E4310
<b>DV:</b>	3

## WELDING POSITIONS

All

## DIAMETERS / PACKAGING

Diameter in (mm)	Length in (mm)	10 lb (4.5 kg) Easy Open Can 30 lb (13.6 kg) Master Carton	50 lb (22.7kg) Easy Open Can
3/32 (2.4)	12 (300)	ED032564	ED010283
1/8 (3.2)	14 (350)	ED032565	ED010278
5/32 (4.0)	14 (350)	ED032566	ED010285
3/16 (4.8)	14 (350)		ED010281

## MECHANICAL PROPERTIES<sup>(1)</sup> – As Required per AWS A5.1

	Yield Strength <sup>(2)</sup> MPa (ksi)	Tensile Strength MPa (ksi)	Elongation %	Charpy V-Notch J (ft-lbf) @-29° C (-20° F)
<b>Requirements - AWS E6010</b>	330 (48) min	430 (60) min	22 min	27 (20) min
<b>Typical Results<sup>(3)</sup> - As-Welded</b>	415-500 (60-73)	500-610 (73-88)	22-29	51-93 (38-69)

## DEPOSIT COMPOSITION<sup>(1)</sup> – As Required per AWS A5.1

	%C	%Mn	%Si	%P	%S
<b>Requirements - AWS E6010</b>	0.20 max	1.20 max	1.00 max	Not Specified	Not Specified
<b>Typical Results<sup>(3)</sup> - As-Welded</b>	0.09-0.20	0.46-0.79	0.10-0.32	0.005-0.017	0.004-0.014
	%Ni	%Cr	%Mo	%V	
<b>Requirements - AWS E6010</b>	0.30 max	0.20 max	0.30 max	0.08 max	
<b>Typical Results<sup>(3)</sup> - As-Welded</b>	≤ 0.04	≤ 0.04	≤ 0.02	≤ 0.01	

## TYPICAL OPERATING PROCEDURES

Polarity <sup>(4)</sup>	Current (Amps)			
	3/32 in (2.4 mm)	1/8 in (3.2 mm)	5/32 in (4.0 mm)	3/16 in (4.8 mm)
DC+	50-85	75-135	100-175	140-225
DC-	50-85	75-135	100-175	–

<sup>(1)</sup>Typical all weld metal. <sup>(2)</sup>Measured with 0.2% offset. <sup>(3)</sup>See test results disclaimer <sup>(4)</sup>Preferred polarity is listed first.

# FLEETWELD® 35

Mild Steel, Cellulosic ▪ AWS E6011

## KEY FEATURES

- Stable arc performance
- High operator appeal
- AC and DC welding

## TYPICAL APPLICATIONS

- Welding on galvanized and specially coated steels
- Sheet metal
- In-plant pipe welding
- Steel with moderate surface contaminants

## CONFORMANCES

AWS A5:	E6011
ABS:	E6011
Lloyd's Register:	3M
ISO:	E4311 A

## WELDING POSITIONS

All

## DIAMETERS / PACKAGING

Diameter in (mm)	Length in (mm)	50 lb (22.7 kg) Carton
3/32 (2.4)	14 (350)	ED028152
1/8 (3.2)	14 (350)	ED028153
5/32 (4.0)	14 (350)	ED028154
3/16 (4.8)	14 (350)	ED028155
7/32 (5.6)	18 (450)	ED032301
1/4 (6.4)	18 (450)	ED028157

## MECHANICAL PROPERTIES<sup>(1)</sup> – As Required per AWS A5.1

	Yield Strength <sup>(2)</sup> MPa (ksi)	Tensile Strength MPa (ksi)	Elongation %	Charpy V-Notch J (ft·lbf) @-29°C (-20°F)
Requirements - AWS E6011	330 (48) min	430 (60) min	22 min	27 (20) min
Typical Results <sup>(3)</sup> - As-Welded	385-415 (56-60)	470-510 (68-74)	26-33	56-101 (42-75)

## DEPOSIT COMPOSITION<sup>(1)</sup> – As Required per AWS A5.1

	%C	%Mn	%Si	%P	%S
Requirements - AWS E6011	0.20 max	1.20 max	1.00 max	Not Specified	Not Specified
Typical Results <sup>(3)</sup> - As-Welded	0.11-0.16	0.32-0.60	0.09-0.28	0.006-0.011	0.004-0.013
	%Ni	%Cr	%Mo	%V	
Requirements - AWS E6011	0.30 max	0.20 max	0.30 max	0.08 max	
Typical Results <sup>(3)</sup> - As-Welded	≤ 0.06	0.01-0.04	≤ 0.02	≤ 0.01	

## TYPICAL OPERATING PROCEDURES

Polarity <sup>(4)</sup>	Current (Amps)					
	3/32 in (2.4 mm)	1/8 in (3.2 mm)	5/32 in (4.0 mm)	3/16 in (4.8 mm)	7/32 in (5.6 mm)	1/4 in (6.4 mm)
AC	50-85	75-120	90-160	120-200	150-260	190-300
DC±	40-75	70-110	80-145	110-180	135-235	170-270

<sup>(1)</sup>Typical all weld metal. <sup>(2)</sup>Measured with 0.2% offset. <sup>(3)</sup>See test results disclaimer <sup>(4)</sup>Preferred polarity is listed first.

# FLEETWELD® 180

Mild Steel, Cellulosic ▪ AWS E6011

## KEY FEATURES

- Performs on low amperages and OCV
- Easy to strike arc
- AC polarity welding

## TYPICAL APPLICATIONS

- Welding on galvanized and specially coated steels
- Small AC welders
- Sheet metal
- Edge, corner and butt joints

## CONFORMANCES

AWS A5: E6011  
CWB/CSA: E4311

## WELDING POSITIONS

All

## DIAMETERS / PACKAGING

Diameter in (mm)	Length in (mm)	1 lb (0.5 kg) Plastic Tube 6 lb (2.7 kg) Master Carton	5 lb (2.3 kg) Plastic Tube 20 lb (9.1 kg) Master Carton*	50 lb (22.7 kg) Easy Open Can
3/32 (2.4)	12 (300)	ED031152, ED033494*	ED033496	ED010110
1/8 (3.2)	14 (350)	ED031722, ED033495*	ED033497	ED010105
5/32 (4.0)	14 (350)			ED010114

\* NOTE: Retail Small Packaging (RSP). All RSP products carry AWS compliance. Unlike the standard products, RSP products have no other agencies approvals.

## MECHANICAL PROPERTIES<sup>(1)</sup> – As Required per AWS A5.1

	Yield Strength <sup>(2)</sup> MPa (ksi)	Tensile Strength MPa (ksi)	Elongation %	Charpy V-Notch J (ft·lbf) @-29°C (-20°F)
Requirements - AWS E6011	330 (48) min	430 (60) min	22 min	27 (20) min
Typical Results <sup>(3)</sup> - As-Welded	460-490 (67-71)	570-590 (83-86)	22-32	35-72 (26-53)

## DEPOSIT COMPOSITION<sup>(1)</sup> – As Required per AWS A5.1

	%C	%Mn	%Si	%P	%S
Requirements - AWS E6011	0.20 max	1.20 max	1.00 max	Not Specified	Not Specified
Typical Results <sup>(3)</sup> - As-Welded	0.13-0.20	0.44-0.71	0.23-0.45	0.009-0.014	0.005-0.008
	%Ni	%Cr	%Mo	%V	
Requirements - AWS E6011	0.30 max	0.20 max	0.30 max	0.08 max	
Typical Results <sup>(3)</sup> - As-Welded	≤ 0.03	≤ 0.03	≤ 0.01	≤ 0.01	

## TYPICAL OPERATING PROCEDURES

Polarity <sup>(4)</sup>	Current (Amps)		
	3/32 in (2.4 mm)	1/8 in (3.2 mm)	5/32 in (4.0 mm)
AC	40-90	65-120	115-150
DC±	40-80	60-110	105-135

<sup>(1)</sup>Typical all weld metal. <sup>(2)</sup>Measured with 0.2% offset. <sup>(3)</sup>See test results disclaimer <sup>(4)</sup>Preferred polarity is listed first.



# MUREX® 6010

Mild Steel, Cellulosic ▪ AWS E6010

## KEY FEATURES

- Light slag with easy slag removal
- Excellent vertical and overhead capability
- Deep arc penetration
- Excellent wash in

## TYPICAL APPLICATIONS

- Construction and field erection
- General fabrication
- Steel with moderate surface contaminants

## CONFORMANCES

AWS A5.1: E6010

ASME SFA-5.1: E6010

## WELDING POSITIONS

All

## DIAMETERS / PACKAGING

Diameter in (mm)	50 lb (22.7kg) Carton
3/32 (2.4)	ED036647
1/8 (3.2)	ED036648
5/32 (4.0)	ED036649

## MECHANICAL PROPERTIES<sup>(1)</sup> – As Required per AWS A5.1

	Yield Strength <sup>(2)</sup> MPa (ksi)	Tensile Strength MPa (ksi)	Elongation %
Typical Results <sup>(3)</sup> - As-Welded	483 (70)	593 (86)	28

## DEPOSIT COMPOSITION<sup>(1)</sup> – As Required per AWS A5.1

	%C	%Mn	%Si	%P	%S
Requirements - AWS E6010	0.20 max	1.20 max	1.0 max	Not Specified	Not Specified
Typical Results <sup>(3)</sup> - As-Welded	0.15-0.17	0.53-0.59	0.25-0.29	0.008-0.011	0.011-0.014
	%Ni	%Cr	%Mo	%V	
Requirements - AWS E6010	0.30 max	0.20 max	0.30 max	0.08 max	
Typical Results <sup>(3)</sup> - As-Welded	0.01-0.05	0.01-0.03	0.01-0.02	0.01	

<sup>(1)</sup>Typical all weld metal. <sup>(2)</sup>Measured with 0.2% offset. <sup>(3)</sup>See test results disclaimer

# MUREX® 6011C

Mild Steel, Cellulosic ▪ AWS E6011

## KEY FEATURES

- Good slag removal
- Deep penetration and fast freezing
- Fast travel speed and flatter contour fillets deliver
- AC Polarity

## TYPICAL APPLICATIONS

- Small AC welders welding on galvanized steel
- Automobile frames, storage tanks and piping
- Rusty or oily steel in maintenance and repair work

## CONFORMANCES

AWS A5.1:	E6011
ASME SFA-5.1:	E6011
ABS:	E6011

## WELDING POSITIONS

All

## DIAMETERS / PACKAGING

Diameter in (mm)	50 lb (22.7 kg) Carton
3/32 (2.4)	EDM13182343
1/8 (3.2)	EDM13182304
5/32 (4.0)	EDM13182305
3/16 (4.8)	EDM13182306

## MECHANICAL PROPERTIES<sup>(1)</sup> – As Required per AWS A5.1

	Yield Strength <sup>(2)</sup> MPa (ksi)	Tensile Strength MPa (ksi)	Elongation %	Charpy V-Notch J (ft·lbf) @-20°C (-29°F)
Requirements - AWS E6011	48,000 (330) min	60,000 (410) min	22 min	20 (27) min
Typical Results <sup>(3)</sup> - As-Welded	57,000-75,000 (393-517)	66,000-86,000 (455-593)	22-35	22-93 (30-126)

## DEPOSIT COMPOSITION<sup>(1)</sup> – As Required per AWS A5.1

	%C	%Mn	%Si	%P	%S
Requirements - AWS E6011	0.20 max	1.20 max	1.00 max	Not Specified	Not Specified
Typical Results <sup>(3)</sup> - As-Welded	0.10-0.16	0.44-0.72	0.10-0.31	0.01-0.02	0.005-0.015
	%Ni	%Cr	%Mo	%V	%Mn + Ni + Cr + Mo + V
Requirements - AWS E6011	0.30 max	0.20 max	0.30 max	0.08 max	Not Specified
Typical Results <sup>(3)</sup> - As-Welded	0.01-0.06	0.01-0.06	0.01-0.06	0.01-0.02	0.48-0.88

## TYPICAL OPERATING PROCEDURES

Current (Amps)			
3/32 in (2.4 mm)	1/8 in (3.2 mm)	5/32 in (4.0 mm)	3/16 in (4.8 mm)
50-90	80-130	120-180	140-220

<sup>(1)</sup>Typical all weld metal. <sup>(2)</sup>Measured with 0.2% offset. <sup>(3)</sup>See test results disclaimer

# FLEETWELD® 22

Mild Steel, Rutile ▪ AWS E6022

## KEY FEATURES

- Optimized for burn-through spot welding
- Deep penetration
- Little slag interference in arc

## TYPICAL APPLICATIONS

- Spot welding floor decking to beams
- Steel with moderate surface contaminants

## CONFORMANCES

AWS A5: E6022

## WELDING POSITIONS

Flat & Horizontal

## DIAMETERS / PACKAGING

Diameter in (mm)	Length in (mm)	50 lb (22.7 kg) Carton
1/8 (3.2)	14 (350)	ED021896
5/32 (4.0)	14 (350)	ED021895

## MECHANICAL PROPERTIES<sup>(1)</sup> – As Required per AWS A5.1

	Tensile Strength MPa (ksi)	Longitudinal Bend Test
<b>Requirements</b> - AWS E6022	430 (60) min	Required
<b>Typical Results<sup>(3)</sup></b> - As-Welded	415-565 (60-82)	Pass

## TYPICAL OPERATING PROCEDURES

Polarity <sup>(4)</sup>	Current (Amps)	
	1/8 in (3.2 mm)	5/32 in (4.0 mm)
AC	110-150	150-180
DC-	110-150	150-180

<sup>(1)</sup>Typical all weld metal. <sup>(2)</sup>Measured with 0.2% offset. <sup>(3)</sup>See test results disclaimer <sup>(4)</sup>Preferred polarity is listed first.

# FLEETWELD® 37

Mild Steel, Rutile ■ AWS E6013

## KEY FEATURES

- Operable with low amperages on sheet metal
- Excellent bead appearance
- Slag control accommodates vertical down welding

## TYPICAL APPLICATIONS

- Maintenance or repair welding
- For use with small AC welders with low OCV
- Sheet metal
- Irregular short welds that change positions

## CONFORMANCES

AWS A5:	E6013
ABS:	E6013
CWB/CSA:	E4313
DNV:	1
Lloyd's Register:	1M
BV:	1
ISO:	E4313 A

## WELDING POSITIONS

All

## DIAMETERS / PACKAGING

Diameter in (mm)	Length in (mm)	1 lb (0.5 kg) Plastic Tube 6 lb (2.7 kg) Master Carton	5 lb (2.3 kg) Plastic Tube 20 lb (9.1 kg) Master Carton*	50 lb (22.7 kg) Carton
5/64 (2.0)	12 (300)			ED010170
3/32 (2.4)	12 (300)	ED033499*	ED033501	ED010161
1/8 (3.2)	14 (350)	ED033500*	ED033502	ED010153
5/32 (4.0)	14 (350)		ED033503	ED010165
3/16 (4.8)	14 (350)			ED010156

\* NOTE: Retail Small Packaging (RSP). All RSP products carry AWS compliance. Unlike the standard products, RSP products have no other agencies approvals.

## MECHANICAL PROPERTIES<sup>(1)</sup> – As Required per AWS A5.1

	Yield Strength <sup>(2)</sup> MPa (ksi)	Tensile Strength MPa (ksi)	Elongation %	Charpy V-Notch J (ft-lbf) @-29°C (-20°F)
Requirements - AWS E6013	330 (48) min	430 (60) min	17 min	Not Specified
Typical Results <sup>(3)</sup> - As-Welded	400-440 (58-64)	460-515 (67-75)	23	37-76 (27-56)

## DEPOSIT COMPOSITION<sup>(1)</sup> – As Required per AWS A5.1

	%C	%Mn	%Si	%P	%S
Requirements - AWS E6013	0.20 max	1.20 max	1.00 max	Not Specified	Not Specified
Typical Results <sup>(3)</sup> - As-Welded	0.04-0.07	0.32-0.45	0.16-0.24	0.01-0.02	0.01-0.02
	%Ni	%Cr	%Mo	%V	
Requirements - AWS E6013	0.30 max	0.20 max	0.30 max	0.08 max	
Typical Results <sup>(3)</sup> - As-Welded	≤ 0.07	0.02 - 0.04	≤ 0.02	0.01-0.02	

## TYPICAL OPERATING PROCEDURES

Polarity <sup>(4)</sup>	Current (Amps)				
	5/64 in (2.0 mm)	3/32 in (2.4 mm)	1/8 in (3.2 mm)	5/32 in (4.0 mm)	3/16 in (4.8 mm)
AC	50-80	75-115	110-140	160-200	205-260
DC±	45-75	70-105	100-135	145-180	185-235

<sup>(1)</sup>Typical all weld metal. <sup>(2)</sup>Measured with 0.2% offset. <sup>(3)</sup>See test results disclaimer <sup>(4)</sup>Preferred polarity is listed first.

# FLEETWELD® 47

Mild Steel, Rutile ▪ AWS E7014

## KEY FEATURES

- Operates on low amperages
- High deposition rates
- Excellent operator appeal

## TYPICAL APPLICATIONS

- Maintenance and repair welding
- Sheet metal and fillet welds
- Heavy sections

## CONFORMANCES

AWS A5:	E7014
ABS:	E7014
CWB/CSA:	E4914
DNV:	1
Lloyd's Register:	1M
BV:	1

## WELDING POSITIONS

All

## DIAMETERS / PACKAGING

Diameter in (mm)	Length in (mm)	1 lb (0.5 kg) Plastic Tube 6 lb (2.7 kg) Master Carton	5 lb (2.3 kg) Plastic Tube 20 lb (9.1 kg) Master Carton*	50 lb (22.7kg) Carton
3/32 (2.4)	14 (350)	ED033504*	ED033506	ED010189
1/8 (3.2)	14 (350)	ED033505*	ED033507	ED010183
5/32 (4.0)	14 (350)		ED033508	ED010193
3/16 (4.8)	14 (350)			ED010186

\* NOTE: Retail Small Packaging (RSP). All RSP products carry AWS compliance. Unlike the standard products, RSP products have no other agencies approvals.

## MECHANICAL PROPERTIES<sup>(1)</sup> – As Required per AWS A5.1

	Yield Strength <sup>(2)</sup> MPa (ksi)	Tensile Strength MPa (ksi)	Elongation %	Charpy V-Notch J (ft-lbf) @ -29° C (-20° F)
Requirements – AWS E7014	400 (58) min	490 (70) min	17 min	Not Specified
Typical Results <sup>(3)</sup> – As-Welded	400-510 (58-74)	490-585 (70-85)	23-29	45-103 (33-76)

## DEPOSIT COMPOSITION<sup>(1)</sup> – As Required per AWS A5.1

	%C	%Mn	%Si	%P	%S
Requirements – AWS E7014	0.15 max	1.25 max	0.90 max	0.035 max	0.035 max
Typical Results <sup>(3)</sup> – As-Welded	0.06-0.10	0.25-0.67	0.04-0.69	0.01-0.02	≤ 0.02
	%Ni	%Cr	%Mo	%V	%Mn + Ni + Cr + Mo + V
Requirements – AWS E7014	0.30 max	0.20 max	0.30 max	0.08 max	1.50 max
Typical Results <sup>(3)</sup> – As-Welded	0.02-0.09	0.01-0.05	≤ 0.02	≤ 0.02	0.37

## TYPICAL OPERATING PROCEDURES

Polarity <sup>(4)</sup>	Current (Amps)			
	3/32 in (2.4 mm)	1/8 in (3.2 mm)	5/32 in (4.0 mm)	3/16 in (4.8 mm)
AC	80-100	110-155	150-225	200-285
DC±	75-95	100-145	135-200	185-235

<sup>(1)</sup>Typical all weld metal. <sup>(2)</sup>Measured with 0.2% offset. <sup>(3)</sup>See test results disclaimer <sup>(4)</sup>Preferred polarity is listed first.



# MUREX® 6013D

Mild Steel, Rutile ▪ AWS E6013

## KEY FEATURES

- Excellent wetting action, yielding smooth and flat beads
- AC or DC polarity
- Low spatter and excellent slag removal – virtually self cleaning on vertical down fillets

## TYPICAL APPLICATIONS

- Good choice when shallow penetration is required or fit up is poor
- All types of mild steel fabrication
- Sheet metal
- Maintenance and repair welding

## CONFORMANCES

AWS A5.1: E6013

ASME SFA-5.1: E6013

## WELDING POSITIONS

All, Ideal for vertical down welding

## DIAMETERS / PACKAGING

Diameter in (mm)	50 lb (22.7 kg) Carton
3/32 (2.4)	EDM13182463
1/8 (3.2)	EDM13182454
5/32 (4.0)	EDM13182455

## MECHANICAL PROPERTIES<sup>(1)</sup> – As Required per AWS A5.1

	Yield Strength <sup>(2)</sup> MPa (ksi)	Tensile Strength MPa (ksi)	Elongation %	Charpy V-Notch J (ft-lbf) @-20°C (-29°F)
Requirements - AWS E6013	48,000 (331) min	60,000 (414) min	17 min	Not Specified
Typical Results <sup>(3)</sup> - As-Welded	48,000-70,000 (331-483)	60,000-78,000 (414-538)	25-32	-

## DEPOSIT COMPOSITION<sup>(1)</sup> – As Required per AWS A5.1

	%C	%Mn	%Si	%P	%S
Requirements - AWS E6013	0.20 max	1.20 max	1.00 max	Not Specified	Not Specified
Typical Results <sup>(3)</sup> - As-Welded	0.05-0.09	0.32-0.41	0.29-0.45	0.01-0.02	0.005-0.015
	%Ni	%Cr	%Mo	%V	%Mn + Ni + Cr + Mo + V
Requirements - AWS E6013	0.30 max	0.20 max	0.30 max	0.08 max	Not Specified
Typical Results <sup>(3)</sup> - As-Welded	0.01-0.06	0.01-0.06	0.01-0.02	0.01-0.02	0.36-0.57

## TYPICAL OPERATING PROCEDURES

Current (Amps)		
3/32 in (2.4 mm)	1/8 in (3.2 mm)	5/32 in (4.0 mm)
65-110	95-150	125-200

<sup>(1)</sup>Typical all weld metal. <sup>(2)</sup>Measured with 0.2% offset. <sup>(3)</sup>See test results disclaimer

# MUREX® 7014

Mild Steel, Rutile ▪ AWS E7014

## KEY FEATURES

- Good restrike characteristics
- Smooth and transfer and good wetting and low penetration
- Good deposition rates

## TYPICAL APPLICATIONS

- Suitable for all types of mild steel fabrications
- Maintenance & repair

## CONFORMANCES

AWS A5.1:	E7014
ASME SFA-5.1:	E7014

## WELDING POSITIONS

Specifically designed for vertical down welding of sheet metal and ornamental iron

## DIAMETERS / PACKAGING

Diameter in (mm)	50 lb (22.7 kg) Carton
3/32 (2.4)	EDM13181403
1/8 (3.2)	EDM13181414
5/32 (4.0)	EDM13181415
3/16 (4.8)	EDM13181416

## MECHANICAL PROPERTIES<sup>(1)</sup> – As Required per AWS A5.1

	Yield Strength <sup>(2)</sup> MPa (ksi)	Tensile Strength MPa (ksi)	Elongation %	Charpy V-Notch J (ft·lbf) @-20°C (-29°F)
Requirements - AWS E7014	58,000 (400) min	70,000 (482) min	17 min	Not Specified
Typical Results <sup>(3)</sup> - As-Welded	58,000-74,000 (399-510)	70,000-83,000 (482-572)	17-29	-
Stress-relieved - 1 hr @ 1150°F (620°C)	55,000-70,000 (379-482)	67,000-77,000 (461-530)	24-30	

## DEPOSIT COMPOSITION<sup>(1)</sup> – As Required per AWS A5.1

	%C	%Mn	%Si	%P	%S
Requirements - AWS E7014	0.15 max	1.25 max	0.90 max	0.035 max	0.035 max
Typical Results <sup>(3)</sup> - As-Welded	0.04-0.09	0.21-0.70	0.45-0.68	0.010-0.020	0.005-0.015
	%Ni	%Cr	%Mo	%V	%Mn + Ni + Cr + Mo + V
Requirements - AWS E7014	0.30 max	0.20 max	0.30 max	0.08 max	1.50 max
Typical Results <sup>(3)</sup> - As-Welded	0.01-0.06	0.01-0.06	0.01-0.02	0.01-0.02	0.25-0.86

## TYPICAL OPERATING PROCEDURES

Current (Amps)			
3/32 in (2.4 mm)	1/8 in (3.2 mm)	5/32 in (4.0 mm)	3/16 in (4.8 mm)
80-100	110-150	140-190	180-260

<sup>(1)</sup>Typical all weld metal. <sup>(2)</sup>Measured with 0.2% offset. <sup>(3)</sup>See test results disclaimer

# JETWELD® 1

Mild Steel, High Deposition ■ AWS E7024-1

## KEY FEATURES

- High deposition rates
- Smooth bead appearance
- Minimal spatter
- Shallow penetration

## TYPICAL APPLICATIONS

- Large welds
- Slightly downhill (15° max) positions
- Multiple pass welding

## CONFORMANCES

AWS A5:	E7024-1
ABS:	E7024-1
CWB/CSA:	E4924-1
DNV:	1
Lloyd's Register:	1M
BV:	1
ISO:	E4924-1 A

## WELDING POSITIONS

Flat & Horizontal

## DIAMETERS / PACKAGING

Diameter in (mm)	Length in (mm)	50 lb (22.7 kg) Carton
1/8 (3.2)	14 (350)	ED010362
5/32 (4.0)	14 (350)	ED010372
3/16 (4.8)	18 (450)	ED010366
7/32 (5.6)	18 (450)	ED010375
1/4 (6.4)	18 (450)	ED010360

## MECHANICAL PROPERTIES<sup>(1)</sup> – As Required per AWS A5.1

	Yield Strength <sup>(2)</sup> MPa (ksi)	Tensile Strength MPa (ksi)	Elongation %	Charpy V-Notch J (ft-lbf) @ -18°C (0°F)
Requirements - AWS E7024-1	400 (58) min	490 (70) min	22 min	27 (20) min
Typical Results <sup>(3)</sup> - As-Welded	455-490 (66-71)	530-565 (77-86)	22-31	27-60 (20-44)

## DEPOSIT COMPOSITION<sup>(1)</sup> – As Required per AWS A5.1

	%C	%Mn	%Si	%P	%S
Requirements - AWS E7024-1	0.15 max	1.25 max	0.90 max	0.035 max	0.035 max
Typical Results <sup>(3)</sup> - As-Welded	0.03-0.06	0.63-1.02	0.13-0.68	0.010-0.022	0.005-0.011
	%Ni	%Cr	%Mo	%V	%Mn + Ni + Cr + Mo + V
Requirements - AWS E7024-1	0.30 max	0.20 max	0.30 max	0.08 max	1.50 max
Typical Results <sup>(3)</sup> - As-Welded	≤ 0.06	0.01-0.05	≤ 0.02	0.03 max.	0.75

## TYPICAL OPERATING PROCEDURES

Polarity <sup>(4)</sup>	Current (Amps)				
	1/8 in (3.2 mm)	5/32 in (4.0 mm)	3/16 in (4.8 mm)	7/32 in (5.6 mm)	1/4 in (6.4 mm)
AC	115-175	180-240	240-300	300-380	340-440
DC±	100-160	160-215	220-280	270-340	320-400

<sup>(1)</sup>Typical all weld metal. <sup>(2)</sup>Measured with 0.2% offset. <sup>(3)</sup>See test results disclaimer <sup>(4)</sup>Preferred polarity is listed first.

# MUREX® 7024

Mild Steel, High Deposition ▪ AWS E7024

## KEY FEATURES

- Good wetting and root fusion in horizontal fillets
- Deposition rate is typically 50% greater than an E7014 electrode
- Self-cleaning slag

## TYPICAL APPLICATIONS

- Large welds
- Barge and shipbuilding
- General fabrication
- Rail car

## CONFORMANCES

<b>AWS A5.1:</b>	E7024
<b>ASME SFA-5.1:</b>	E7024
<b>ABS:</b>	E7024

## WELDING POSITIONS

Flat & horizontal

## DIAMETERS / PACKAGING

Diameter in (mm)	50 lb (22.7 kg) Carton
1/8 (3.2)	EDM13181214
5/32 (4.0)	EDM13181215
3/16 (4.8)	EDM13181216
7/32 (5.6)	EDM13181217
1/4 (6.4)	EDM13181218

## MECHANICAL PROPERTIES<sup>(1)</sup> – As Required per AWS A5.1

	Yield Strength <sup>(2)</sup> MPa (ksi)	Tensile Strength MPa (ksi)	Elongation %
<b>Requirements - AWS E7024</b>	58,000 (399) min	70,000 (482) min	17 min
<b>Typical Results<sup>(3)</sup> - As-Welded</b>	58,000-74,000 (399-510)	70,000-83,000 (482-572)	17-29
<b>Stress-relieved - 1 hr @ 1150 °F (620 °C)</b>	67,000-77,000 (462-531)	55,000-70,000 (379-483)	24-30

## DEPOSIT COMPOSITION<sup>(1)</sup> – As Required per AWS A5.1

	%C	%Mn	%Si	%P	%S
<b>Requirements - AWS E7024</b>	0.15 max	1.25 max	0.90 max	0.035 max	0.035 max
<b>Typical Results<sup>(3)</sup> - As-Welded</b>	0.04-0.09	0.75-1.10	0.29-0.57	0.010-0.020	0.010-0.020
	%Ni	%Cr	%Mo	%V	%Mn + Ni + Cr + Mo + V
<b>Requirements - AWS E7024</b>	0.30 max	0.20 max	0.30 max	0.08 max	1.50 max
<b>Typical Results<sup>(3)</sup> - As-Welded</b>	0.005-0.015	0.01-0.06	0.01-0.06	0.01-0.02	0.79-1.26

## TYPICAL OPERATING PROCEDURES

Current (Amps)				
1/8 in (3.2 mm)	5/32 in (4.0 mm)	3/16 in (4.8 mm)	7/32 in (5.6 mm)	1/4 in (6.4 mm)
100-175	160-240	250-300	300-350	350-400

<sup>(1)</sup>Typical all weld metal. <sup>(2)</sup>Measured with 0.2% offset. <sup>(3)</sup>See test results disclaimer

# EXCALIBUR® 7018 MR®

Mild Steel, Low Hydrogen ▪ AWS E7018 H4R



## KEY FEATURES

- Exceeds AWS "R" requirements
- Premium arc performance
- Extreme bend ability
- Excellent moisture resistance
- Clean arc starts
- Clear puddle and a smooth arc

## TYPICAL APPLICATIONS

- Mild steel
- Chemical Processing Structures
- Structural
- Structural
- Structural
- Ship Building
- Pressure piping

## CONFORMANCES

<b>AWS A5:</b>	E7018 H4R
<b>ABS:</b>	3YH5
<b>CWB/CSA:</b>	E4918
<b>DNV:</b>	3YH5
<b>Lloyd's Register:</b>	3YM H5
<b>BV:</b>	3YHHH
<b>ISO:</b>	E4918 A H5

## WELDING POSITIONS

All, except vertical down

## DIAMETERS / PACKAGING

Diameter in (mm)	Length in (mm)	1 lb (0.5 kg) Plastic Tube 6 lb (2.7 kg) Master Carton	10 lb (4.5 kg) Easy Open Can 30 lb (13.6 kg) Master Carton	50 lb (22.7kg) Easy Open Can
3/32 (2.4)	14 (350)	ED032086	ED032588	ED028280, ED033868*
1/8 (3.2)	14 (350)	ED031468	ED032589	ED028281, ED033869*
5/32 (4.0)	14 (350)		ED032590	ED028282, ED033870*
3/16 (4.8)	14 (350)			ED028283, ED033871*
7/32 (5.6)	18 (450)			ED028917
1/4 (6.4)	18 (450)			ED028918

\*Buy America Product

## MECHANICAL PROPERTIES<sup>(1)</sup> – As Required per AWS A5.1

	Yield Strength <sup>(2)</sup> MPa (ksi)	Tensile Strength MPa (ksi)	Elongation %	Charpy V-Notch J (ft-lbf) @ -29°C (-20°F)
<b>Requirements</b> - AWS E7018 H4R	400 (58) min	490 (70) min	22 min	27 (20) min
<b>Typical Results<sup>(3)</sup></b> - As-Welded	430-510 (62-74)	510-605 (74-88)	25-37	121-332 (89-246)

## DEPOSIT COMPOSITION<sup>(1)</sup> – As Required per AWS A5.1

	%C	%Mn	%Si	%P	%S	%Ni
<b>Requirements</b> - AWS E7018 H4R	0.15 max	1.60 max	0.75 max	0.035 max	0.035 max	0.30 max
<b>Typical Results<sup>(3)</sup></b>	0.03-0.08	1.01-1.55	0.34-0.68	0.01-0.02	≤ 0.01	0.01-0.06
	%Cr	%Mo	%V	%Mn + Ni + Cr + Mo + V	Diffusible Hydrogen (mL/100g weld metal)	
<b>Requirements</b> - AWS E7018 H4R	0.20 max	0.30 max	0.08 max	1.75 max	4.0 max	
<b>Typical Results<sup>(3)</sup></b>	0.02-0.07	≤ 0.05	≤ 0.02	1.04-1.75	2-3	

## TYPICAL OPERATING PROCEDURES

Polarity <sup>(4)</sup>	Current (Amps)					
	3/32 in (2.4 mm)	1/8 in (3.2 mm)	5/32 in (4.0 mm)	3/16 in (4.8 mm)	7/32 in (5.6 mm)	1/4 in (6.4 mm)
DC+	70-110	90-160	130-210	180-300	250-330	300-400
AC	80-120	100-160	140-210	200-300	270-370	325-420

<sup>(1)</sup>Typical all weld metal. <sup>(2)</sup>Measured with 0.2% offset. <sup>(3)</sup>See test results disclaimer <sup>(4)</sup>Preferred polarity is listed first.



# EXCALIBUR® 7018-1 MR®

Mild Steel, Low Hydrogen ▪ AWS E7018-1 H4R



## KEY FEATURES

- Exceeds AWS toughness requirements at -50°F
- Extreme bend ability
- Moisture pick-up resistant
- Clear puddle and a smooth arc
- Meets Chemical Composition Recommendations of API 751
- Q2 Lot® - Lot Controlled Chemistry and Mechanical Properties

## TYPICAL APPLICATIONS

- Power generation
- Chemical Processing Structures
- Pressure vessels
- Pressure piping
- Structural

## CONFORMANCES

<b>AWS A5:</b>	E7018, E7018-1 H4R
<b>ABS:</b>	3YH5
<b>CWB/CSA:</b>	E4918-1-H4R
<b>DNV:</b>	3YH5
<b>Lloyd's Register:</b>	3YM H5
<b>BV:</b>	3YHHH
<b>ISO:</b>	E 42 4 Z B 3 2 H5 E4918-1 A U H5

## WELDING POSITIONS

All, except vertical down

## DIAMETERS / PACKAGING

Diameter in (mm)	Length in (mm)	8 lb (3.6 kg) Easy Open Can 24 lb (10.9 kg) Master Carton	10 lb (4.5 kg) Easy Open Can 30 lb (13.6 kg) Master Carton	50 lb (22.7kg) Easy Open Can
3/32 (2.4)	12 (300)	ED033179	ED032591 ED032592	ED028700, ED034308* ED028702, ED034309* ED028704 ED028706 ED028919 ED028920
3/32 (2.4)	14 (350)			
1/8 (3.2)	14 (350)			
5/32 (4.0)	14 (350)			
3/16 (4.8)	14 (350)			
7/32 (5.6)	18 (450)			
1/4 (6.4)	18 (450)			

\*Buy America Product

## MECHANICAL PROPERTIES<sup>(1)</sup> – As Required per AWS A5.1

	Yield Strength <sup>(2)</sup> MPa (ksi)	Tensile Strength MPa (ksi)	Elongation %	Charpy V-Notch J (ft·lbf) @ -46°C (-50°F)
<b>Requirements</b> - AWS E7018-1 H4R	400 (58) min	490 (70) min	22 min	27 (20) min
<b>Typical Results<sup>(3)</sup></b> - As-Welded	405-515 (59-75)	530-605 (77-88)	24-36	56-178 (42-131)

## DEPOSIT COMPOSITION<sup>(1)</sup> – As Required per AWS A5.1

	%C	%Mn	%Si	%P	%S	%Ni
<b>Requirements</b> - AWS E7018-1 H4R	0.15 max	1.60 max	0.75 max	0.035 max	0.035 max	0.30 max
<b>Typical Results<sup>(3)</sup></b>	0.04-0.07	0.80-1.44	0.28-0.51	0.006-0.019	0.003-0.013	0.01-0.07
	%Cr	%Mo	%V	%Mn + Ni + Cr + Mo + V	Diffusible Hydrogen (mL/100g weld metal)	
<b>Requirements</b> - AWS E7018-1 H4R	0.20 max	0.30 max	0.08 max	1.75 max	4.0 max	
<b>Typical Results<sup>(3)</sup></b>	0.01-0.07	0.11-0.28	≤ 0.01	0.93-1.65	2-3	

## TYPICAL OPERATING PROCEDURES

Polarity <sup>(4)</sup>	Current (Amps)					
	3/32 in (2.4 mm)	1/8 in (3.2 mm)	5/32 in (4.0 mm)	3/16 in (4.8 mm)	7/32 in (5.6 mm)	1/4 in (6.4 mm)
DC+	70-110	90-160	130-210	180-300	250-330	300-400
AC	80-120	100-160	140-210	200-300	270-370	325-420

<sup>(1)</sup>Typical all weld metal. <sup>(2)</sup>Measured with 0.2% offset. <sup>(3)</sup>See test results disclaimer <sup>(4)</sup>Preferred polarity is listed first.

# EXCALIBUR® 7028

Mild Steel, Low Hydrogen ■ AWS E7028 H8



## KEY FEATURES

- High deposition rates
- Premium arc performance
- High travel speed
- Capable of producing weld deposits with impact toughness exceeding 84 J (60 ft•lbf) at -40°C (-40°F)

## TYPICAL APPLICATIONS

- Structural
- Heavy fabrication
- Shipbuilding
- Storage tanks
- Bridge fabrication

## CONFORMANCES

AWS A5:	E7028-H8
ABS:	3YH10
CWB/CSA:	E4928-H8
DNV:	3YH10
Lloyd's Register:	3YM H10
BV:	3YHHH
ISO:	E4918 A H5

## WELDING POSITIONS

Flat &amp; Horizontal

## DIAMETERS / PACKAGING

Diameter in (mm)	Length in (mm)	50 lb (22.7 kg) Easy Open Can
5/32 (4.0)	14 (350)	ED032636, EDO34312*
3/16 (4.8)	18 (450)	ED032790, EDO34313*

\*Buy America Product

## MECHANICAL PROPERTIES<sup>(1)</sup> – As Required per AWS A5.1

	Yield Strength <sup>(2)</sup> MPa (ksi)	Tensile Strength MPa (ksi)	Elongation %	Charpy V-Notch J (ft•lbf) @ -18°C (0°F)
Requirements - AWS E7028 H8	400 (58) min	490 (70) min	22 min	27 (20) min
Typical Results <sup>(3)</sup> - As-Welded	450-470 (66-69)	540-560 (77-85)	27-34	84-193 (62-142)

## DEPOSIT COMPOSITION<sup>(1)</sup> – As Required per AWS A5.1

	%C	%Mn	%Si	%P	%S	%Ni
Requirements - AWS E7028 H8	0.15 max	1.60 max	0.90 max	0.035 max	0.035 max	0.30 max
Typical Results <sup>(3)</sup>	0.03-0.06	1.17-1.51	0.44-0.77	0.007-0.014	0.004-0.008	0.02-0.04
	%Cr	%Mo	%V	%Mn + Ni + Cr + Mo + V	Diffusible Hydrogen (mL/100g weld metal)	
Requirements - AWS E7028 H8	0.20 max	0.30 max	0.08 max	1.75 max	8.0 max	
Typical Results <sup>(3)</sup>	0.02-0.05	0.01-0.03	0.02 max.	1.25-1.62	4-5	

## TYPICAL OPERATING PROCEDURES

Polarity <sup>(4)</sup>	Current (Amps)		
	5/32 in (4.0 mm)	3/16 in (4.8 mm)	7/32 in (5.6 mm)
DC+	125-175	185-245	220-280
AC	130-180	190-250	250-310

<sup>(1)</sup>Typical all weld metal. <sup>(2)</sup>Measured with 0.2% offset. <sup>(3)</sup>See test results disclaimer <sup>(4)</sup>Preferred polarity is listed first.

# JETWELD® LH-70

Mild Steel, Low Hydrogen ■ AWS E7018 H4R

## KEY FEATURES

- Smooth arc performance

## TYPICAL APPLICATIONS

- General fabrication
- Ship Building

## WELDING POSITIONS

All, except vertical down

## CONFORMANCES

**AWS A5:** E7018, E7018 H4R

**ABS:** 3YH10 E7018

**CWB/CSA:** E4918-1

**DNV:** 3 Y40H5

**Lloyd's Register:** 3YM H5

**BV:** 3YHHH

## DIAMETERS / PACKAGING

Diameter in (mm)	Length in (mm)	44 lb (20 kg) Easy Open Can	50 lb (22.7 kg) Easy Open Can
3/32 (2.4)	14 (350)	ED037050	ED010568
1/8 (3.2)	14 (350)		
5/32 (4.0)	14 (350)		ED010575
3/16 (4.8)	14 (350)		ED010564
7/32 (5.6)	18 (450)		ED010577
1/4 (6.4)	18 (450)		ED010558

## MECHANICAL PROPERTIES<sup>(1)</sup> – As Required per AWS A5.1

	Yield Strength <sup>(2)</sup> MPa (ksi)	Tensile Strength MPa (ksi)	Elongation %	Charpy V-Notch J (ft·lbf) @ -29° C (-20° F)
<b>Requirements</b> - AWS E7018 H4R	400 (58) min	490 (70) min	22 min	27 (20) min
<b>Typical Results</b> <sup>(3)</sup> - As-Welded	400-485 (58-70)	490-570 (71-83)	23-36	156-334 (115-246)

## DEPOSIT COMPOSITION<sup>(1)</sup> – As Required per AWS A5.1

	%C	%Mn	%Si	%P	%S	%Ni
<b>Requirements</b> - AWS E7018 H4R	0.15 max	1.60 max	0.75 max	0.035 max	0.035 max	0.30 max
<b>Typical Results</b> <sup>(3)</sup>	0.04-0.08	0.95-1.17	0.30-0.53	0.01-0.02	≤ 0.02	0.01-0.05
	%Cr	%Mo	%V	%Mn + Ni + Cr + Mo + V	Diffusible Hydrogen (mL/100g weld metal)	
<b>Requirements</b> - AWS E7018 H4R	0.20 max	0.30 max	0.08 max	1.75 max	4.0 max	
<b>Typical Results</b> <sup>(3)</sup>	0.03-0.06	≤ 0.02	≤ 0.02	1.05-1.50	1-2	

## TYPICAL OPERATING PROCEDURES

Polarity <sup>(4)</sup>	Current (Amps)					
	3/32 in (2.4 mm)	1/8 in (3.2 mm)	5/32 in (4.0 mm)	3/16 in (4.8 mm)	7/32 in (5.6 mm)	1/4 in (6.4 mm)
DC+	70-110	90-150	120-190	170-280	210-330	290-430
AC	80-120	110-170	135-225	200-300	260-380	325-440

<sup>(1)</sup>Typical all weld metal. <sup>(2)</sup>Measured with 0.2% offset. <sup>(3)</sup>See test results disclaimer <sup>(4)</sup>Preferred polarity is listed first.

# JET-LH<sup>®</sup> 78 MR<sup>®</sup>

Mild Steel, Low Hydrogen ■ AWS E7018 H4R

## KEY FEATURES

- Smooth arc performance

## TYPICAL APPLICATIONS

- General fabrication

## WELDING POSITIONS

All, except vertical down

## CONFORMANCES

AWS A5: E7018, E7018 H4R

ABS: E7018

CWB/CSA: E4918-1

DNV: 3YH5

Lloyd's Register: 3YM H5

BV: 3YHHH

## DIAMETERS / PACKAGING

Diameter in (mm)	Length in (mm)	5 lb (2.3 kg) Plastic Tube 20 lb (9.1 kg) Master Carton*	50 lb (22.7 kg) Easy Open Can
3/32 (2.4)	12 (300)	ED033517	ED015161
1/8 (3.2)	14 (350)	ED033518	ED015198
5/32 (4.0)	14 (350)	ED033519	ED015141
3/16 (4.8)	14 (350)		ED015186
1/4 (6.4)	18 (450)		ED015383

\* NOTE: Retail Small Packaging (RSP). All RSP products carry AWS compliance. Unlike the standard products, RSP products have no other agencies approvals.

## MECHANICAL PROPERTIES<sup>(1)</sup> – As Required per AWS A5.1

	Yield Strength <sup>(2)</sup> MPa (ksi)	Tensile Strength MPa (ksi)	Elongation %	Charpy V-Notch J (ft-lbf) @ -29°C (-20°F)
<b>Requirements</b> – AWS E7018 H4R	400 (58) min	490 (70) min	22 min.	27 (20) min
<b>Typical Results<sup>(3)</sup></b> – As-Welded	415-570 (60-83)	495-640 (72-93)	22-34	156-353 (115-260)

## DEPOSIT COMPOSITION<sup>(1)</sup> – As Required per AWS A5.1

	%C	%Mn	%Si	%P	%S	%Ni
<b>Requirements</b> – AWS E7018 H4R	0.15 max	1.60 max	0.75 max	0.035 max	0.035 max	0.30 max
<b>Typical Results<sup>(3)</sup></b>	0.04-0.07	0.75-1.35	0.13-0.69	≤ 0.01	≤ 0.01	0.02-0.04
	%Cr	%Mo	%V	%Mn + Ni + Cr + Mo + V	Diffusible Hydrogen (mL/100g weld metal)	
<b>Requirements</b> – AWS E7018 H4R	0.20 max	0.30 max	0.08 max	1.75 max	4.0 max	
<b>Typical Results<sup>(3)</sup></b>	0.02-0.06	≤ 0.03	≤ 0.03	1.00-1.40	1-3	

## TYPICAL OPERATING PROCEDURES

Polarity <sup>(4)</sup>	Current (Amps)				
	3/32 in (2.4 mm)	1/8 in (3.2 mm)	5/32 in (4.0 mm)	3/16 in (4.8 mm)	1/4 in (6.4 mm)
DC+	65-100	110-160	130-200	180-270	300-400
AC	70-105	120-170	140-230	210-290	325-420

<sup>(1)</sup>Typical all weld metal. <sup>(2)</sup>Measured with 0.2% offset. <sup>(3)</sup>See test results disclaimer <sup>(4)</sup>Preferred polarity is listed first.

# LINCOLN® 7018 AC

Mild Steel, Low Hydrogen ■ AWS E7018 H8

## KEY FEATURES

- AC polarity welding
- Low open circuit voltage operation
- Minimal spatter
- Capable of cold re-strikes

## TYPICAL APPLICATIONS

- General fabrication
- Tack and skip welds
- Thin sections

## CONFORMANCES

<b>AWS A5.1:</b>	E7018 H8
<b>ASME SFA-A5.1:</b>	E7018 H8
<b>CWB/CSA W48-06:</b>	E4918-H8

## WELDING POSITIONS

All, except vertical down

## DIAMETERS / PACKAGING

Diameter in (mm)	Length in (mm)	1 lb (0.5 kg) Plastic Tube 6 lb (2.7 kg) Master Carton	5 lb (2.3 kg) Plastic Tube 20 lb (9.1 kg) Master Carton*	50 lb (22.7 kg) Easy Open Can
3/32 (2.4)	14 (350)	ED031714, ED033512*	ED033514	ED031732
1/8 (3.2)	14 (350)	ED031715, ED033513*	ED033515	ED031734
5/32 (4.0)	14 (350)		ED033516	ED031738

\* NOTE: Retail Small Packaging (RSP). All RSP products carry AWS compliance. Unlike the standard products, RSP products have no other agencies approvals.

## MECHANICAL PROPERTIES<sup>(1)</sup> – As Required per AWS A5.1

	Yield Strength <sup>(2)</sup> MPa (ksi)	Tensile Strength MPa (ksi)	Elongation %	Charpy V-Notch J (ft-lbf) @ -29°C (-20°F)
<b>Requirements</b> – AWS E7018 H8	400 (58) min	490 (70) min	22 min	27 (20) min
<b>Typical Results<sup>(3)</sup></b> – As-Welded	435-625 (63-80)	515-685 (75-90)	23-29	27-76 (20-56)

## DEPOSIT COMPOSITION<sup>(1)</sup> – As Required per AWS A5.1

	%C	%Mn	%Si	%P	%S	%Ni
<b>Requirements</b> – AWS E7018 H8	0.15 max	1.60 max	0.75 max	0.035 max	0.035 max	0.30 max
<b>Typical Results<sup>(3)</sup></b>	0.04-0.07	1.00-1.60	0.32-0.63	0.01-0.02	≤ 0.01	0.01-0.03
	%Cr	%Mo	%V	%Mn + Ni + Cr + Mo + V	Diffusible Hydrogen (mL/100g weld metal)	
<b>Requirements</b> – AWS E7018 H8	0.20 max	0.30 max	0.08 max	1.75 max	8.0 max	
<b>Typical Results<sup>(3)</sup></b>	0.03-0.08	≤ 0.01	0.02-0.05	1.00-1.40	2-4	

## TYPICAL OPERATING PROCEDURES

Polarity <sup>(4)</sup>	Current (Amps)		
	3/32 in (2.4 mm)	1/8 in (3.2 mm)	5/32 in (4.0 mm)
AC	75-120	105-150	130-200
DC+	70-115	100-140	120-185

<sup>(1)</sup>Typical all weld metal. <sup>(2)</sup>Measured with 0.2% offset. <sup>(3)</sup>See test results disclaimer <sup>(4)</sup>Preferred polarity is listed first.

# MILLENNIUM ARC® 7018-1

Mild Steel, Low Hydrogen ■ AWS E7018-1 H4R

## KEY FEATURES

- Moisture pick-up resistant
- Clear weld puddle without slag interference
- Effortless slag removal
- No intentional addition of zinc for moisture resistance

## TYPICAL APPLICATIONS

- Power generation
- Chemical Processing Structurel
- Pressure piping

## CONFORMANCES

<b>AWS A5.1:</b>	E7018-1 H4R
<b>ASME SFA-A5.1:</b>	E7018-1 H4R
<b>CWB/CSA W48-06:</b>	E4918-1-H4

## WELDING POSITIONS

All, except vertical down

## DIAMETERS / PACKAGING

Diameter in (mm)	Length in (mm)	1 lb (0.5 kg) Plastic Tube 6 lb (2.7 kg) Master Carton	10 lb (4.5 kg) Easy Open Can 30 lb (13.6 kg) Master Carton	12 lb (4.5 kg) Easy Open Can 36 lb (13.6 kg) Master Carton	50 lb (22.7kg) Easy Open Can
3/32 (2.4)	14 (350)	ED036305	ED036326	-	ED035456
1/8 (3.2)	14 (350)	ED036304	ED036325	-	ED035314
5/32 (4.0)	14 (350)	-	ED036327	-	ED035457
5.0 mm*	14 (350)	-	ED036757	-	ED036756
5.0 mm*	18 (450)	-	-	ED036759	ED036758

\* Manufactured to Metric Units.

## MECHANICAL PROPERTIES<sup>(1)</sup> – As Required per AWS A5.1

	Yield Strength <sup>(2)</sup> MPa (ksi)	Tensile Strength MPa (ksi)	Elongation %	Joules @ -46°C (ft-lbs @ -50°F)
<b>Requirements</b> AWS E7018-1 H4R	400 (58) min	480 (70) min	22 min	27 (20) min
<b>Typical Results<sup>(3)</sup></b> As-Welded	440-550 (64-72)	540-600 (78-86)	>27	120-180 (90-130)

## DEPOSIT COMPOSITION<sup>(1)</sup> – As Required per AWS A5.1

	%C	%Mn	%Si	%P	%S	%Ni
<b>Requirements</b> AWS E7018-1 H4R	0.15 max	1.60 max	0.75 max	0.035 max	0.035 max	0.30 max
<b>Typical Results<sup>(3)</sup></b>	0.06-0.08	1.2-1.5	0.4-0.6	0.01-0.02	0.01-0.02	<0.1
	%Cr	%Mo	%V	%Mn + Ni + Cr + Mo + V	Diffusible Hydrogen (mL/100g weld metal)	
<b>Requirements</b> AWS E7018-1 H4R	0.20 max	0.30 max	0.08 max	1.75 max	4.0 max	
<b>Typical Results<sup>(3)</sup></b>	<0.1	<0.1	<0.01	1.3-1.5	1-3	

## TYPICAL OPERATING PROCEDURES

Polarity <sup>(4)</sup>	Current (Amps)				
	3/32 in (2.4 mm)	1/8 in (3.2 mm)	5/32 in (4.0 mm)	5.0 mm	6.0 mm
DC+	70-110	90-160	120-220	150-300	200-370
AC	80-120	100-160	130-220	160-320	220-360

<sup>(1)</sup>Typical all weld metal. <sup>(2)</sup>Measured with 0.2% offset. <sup>(3)</sup>See test results disclaimer <sup>(4)</sup>Preferred polarity is listed first.

# MUREX® B7018 MR®

Mild Steel, Low Hydrogen ▪ AWS E7018 H4R

## KEY FEATURES

- Easy slag removal
- Capable of x-ray quality
- Meets tough AWS limits for low moisture pick-up

## TYPICAL APPLICATIONS

- Designed for welding hardenable steels
- Cold roll steels, or other steels containing high sulfur or selenium
- Thick sections and restrained joints
- Structural steel

## CONFORMANCES

AWS A5.1:	E7018 H4R
ASME SFA-5.1:	E7018 H4R
ABS:	E7018

## WELDING POSITIONS

All but vertical down

## DIAMETERS / PACKAGING

Diameter in (mm)	50 lb (22.7 kg) Carton
3/32 (2.4)	EDM13182833
1/8 (3.2)	EDM13182834
5/32 (4.0)	EDM13182835

## MECHANICAL PROPERTIES<sup>(1)</sup> – As Required per AWS A5.1

	Yield Strength <sup>(2)</sup> MPa (ksi)	Tensile Strength MPa (ksi)	Diffusible Hydrogen ml/100g Weld Deposit	Elongation %	Charpy V-Notch J (ft·lbf) @ -20°F (-29°C)
<b>Requirements -</b> AWS E7018 H4, E7018 H4R	58,000 (400) min	70,000 (483) min	4.0 max	22 min	27 (20) min
<b>Typical Results<sup>(3)</sup></b>	60,000-69,000 (414-476)	74,000-83,000 (510-572)	1-4	30-36	20-221 (27-300)

## DEPOSIT COMPOSITION<sup>(1)</sup> – As Required per AWS A5.1

	%C	%Mn	%Si	%P	%S
<b>Requirements -</b> AWS E7018 H4, E7018 H4R	0.15 max	1.60 max	0.75 max	0.035 max	0.035 max
<b>Typical Results<sup>(3)</sup> - As-Welded</b>	0.04-0.08	1.00-1.30	0.35-0.65	0.010-0.020	0.005-0.015
	%Ni	%Cr	%Mo	%V	%Mn + Ni + Cr + Mo + V
<b>Requirements -</b> AWS E7018 H4, E7018 H4R	0.30 max	0.20 max	0.30 max	0.08 max	1.75 max
<b>Typical Results<sup>(3)</sup> - As-Welded</b>	0.01-0.06	0.01-0.06	0.01-0.02	0.01-0.02	1.04-1.46

## TYPICAL OPERATING PROCEDURES

Current (Amps)			
3/32 (2.4 mm)	1/8 in (3.2 mm)	5/32 in (4.0 mm)	3/16 in (4.8 mm)
70-110	110-150	120-200	200-275

<sup>(1)</sup>Typical all weld metal. <sup>(2)</sup>Measured with 0.2% offset. <sup>(3)</sup>See test results disclaimer

# MUREX® 7018 MR®

Mild Steel, Low Hydrogen ■ AWS E7018 H4R

## KEY FEATURES

- Capable of meeting the highest quality x-ray requirements
- Excellent operator appeal soft, quiet arc with very low spatter
- Meets tough AWS limits for low moisture pick-up

## TYPICAL APPLICATIONS

- Low alloy structural steels
- Shipyard
- Field erection

## CONFORMANCES

<b>AWS A5.1:</b>	E7018 H4R
<b>ASME SFA-5.1:</b>	E7018 H4R
<b>ABS:</b>	E7018

## WELDING POSITIONS

All but vertical down

## DIAMETERS / PACKAGING

Diameter in (mm)	50 lb (22.7 kg) Carton
3/32 (2.4)	EDM13187183
1/8 (3.2)	EDM13187184
5/32 (4.0)	EDM13187185
3/16 (4.8)	EDM13187186
1/4 (6.4)	EDM13187188

## MECHANICAL PROPERTIES<sup>(1)</sup> – As Required per AWS A5.1

	Yield Strength <sup>(2)</sup> MPa (ksi)	Tensile Strength MPa (ksi)	Diffusible Hydrogen ml/100g Weld Deposit	Elongation %	Charpy V-Notch J (ft·lbf) @ -20°F (-29°C)
<b>Requirements -</b> AWS E7018 H4, E7018 H4R	58,000 (400) min	70,000 (483) min	4.0 max	22 min	27 (20) min
<b>Typical Results<sup>(3)</sup></b>	60,000-69,000 (414-476)	74,000-83,000 (510-572)	1-4	20-36	20-221 (27-300)

## DEPOSIT COMPOSITION<sup>(1)</sup> – As Required per AWS A5.1

	%C	%Mn	%Si	%P	%S
<b>Requirements -</b> AWS E7018 H4, E7018 H4R	0.15 max	1.60 max	0.75 max	0.035 max	0.035 max
<b>Typical Results<sup>(3)</sup> - As-Welded</b>	0.04-0.08	1.00-1.30	0.35-0.65	0.010-0.020	0.005-0.015
	%Ni	%Cr	%Mo	%V	%Mn + Ni + Cr + Mo + V
<b>Requirements -</b> AWS E7018 H4, E7018 H4R	0.30 max	0.20 max	0.30 max	0.08 max	1.75 max
<b>Typical Results<sup>(3)</sup> - As-Welded</b>	0.01-0.06	0.01-0.06	0.01-0.02	0.01-0.02	1.04-1.46

## TYPICAL OPERATING PROCEDURES

		Current (Amps)		
3/32 (2.4 mm)	1/8 in (3.2 mm)	5/32 in (4.0 mm)	3/16 in (4.8 mm)	1/4 in (6.4 mm)
70-110	100-150	120-200	200-275	300-400

<sup>(1)</sup>Typical all weld metal. <sup>(2)</sup>Measured with 0.2% offset. <sup>(3)</sup>See test results disclaimer



# SHIELD-ARC® HYP+

Low Alloy, Cellulosic, Pipe ▪ AWS E7010-P1

## KEY FEATURES

- Light slag for minimal arc interference
- Deep penetration
- Clean, visible weld puddle
- Superior puddle control

## TYPICAL APPLICATIONS

- Root pass welding of up to X80 grade pipe
- Hot, fill and cap pass of up to X65 grade pipe

## CONFORMANCES

<b>AWS A5:</b>	E7010-P1
<b>ABS:</b>	E7010-P1
<b>CWB/CSA:</b>	E4910-P1

## WELDING POSITIONS

Recommended for vertical down welding

## DIAMETERS / PACKAGING

Diameter in (mm)	Length in (mm)	50 lb (22.7 kg) Easy Open Can
1/8 (3.2)	14 (350)	ED029511
5/32 (4.0)	14 (350)	ED029513
3/16 (4.8)	14 (350)	ED029509

## MECHANICAL PROPERTIES<sup>(1)</sup> – As Required per AWS A5.5

	Yield Strength <sup>(2)</sup> MPa (ksi)	Tensile Strength MPa (ksi)	Elongation %	Charpy V-Notch J (ft-lbf) @ -29°C (-20°F)
<b>Requirements</b> - AWS E7010-P1	415 (60) min	490 (70) min	22 min	27 (20) min
<b>Typical Results<sup>(3)</sup></b> - As-Welded	435-525 (63-76)	525-635 (76-92)	22-28	27-56 (20-41)

## DEPOSIT COMPOSITION<sup>(1)</sup> – As Required per AWS A5.5

	%C	%Mn	%Si	%P	%S
<b>Requirements</b> - AWS E7010-P1	0.20 max	1.20 max	0.60 max	0.03 max	0.03 max
<b>Typical Results<sup>(3)</sup></b>	0.13-0.17	0.43-0.63	0.08-0.18	≤ 0.01	≤ 0.01
	%Ni	%Cr	%Mo	%V	
<b>Requirements</b> - AWS E7010-P1	1.00 max	0.30 max	0.50 max	0.10 max	
<b>Typical Results<sup>(3)</sup></b>	0.01-0.02	0.02	0.27-0.31	< 0.01	

## TYPICAL OPERATING PROCEDURES

Polarity	Current (Amps)		
	1/8 in (3.2 mm)	5/32 in (4.0 mm)	3/16 in (4.8 mm)
DC+	75-130	90-185	140-225

<sup>(1)</sup>Typical all weld metal. <sup>(2)</sup>Measured with 0.2% offset. <sup>(3)</sup>See test results disclaimer

# SHIELD-ARC® 85

Low Alloy, Cellulosic, Pipe ▪ AWS E7010-A1

## KEY FEATURES

- For welding 0.50% molybdenum steel
- Deep penetration and superior puddle control
- Light slag for minimal arc interference
- Clean, visible weld puddle

## TYPICAL APPLICATIONS

- API 5L X42 through X56 grade pipe
- Cross country and in-plant pipe

## CONFORMANCES

<b>AWS A5:</b>	E7010-A1
<b>ABS:</b>	E7010-A1
<b>CWB/CSA:</b>	E4910-A1

## WELDING POSITIONS

All

## DIAMETERS / PACKAGING

Diameter in (mm)	Length in (mm)	50 lb (22.7 kg) Easy Open Can
3/32 (2.4)	12 (300)	ED012893
1/8 (3.2)	14 (350)	ED012885
5/32 (4.0)	14 (350)	ED012896
3/16 (4.8)	14 (350)	ED012889

## MECHANICAL PROPERTIES<sup>(1)</sup> – As Required per AWS A5.5

	Yield Strength <sup>(2)</sup> MPa (ksi)	Tensile Strength MPa (ksi)	Elongation %	Charpy V-Notch J (ft-lbf) @ -29°C (-20°F)
<b>Requirements</b> - AWS E7010-A1	390 (57) min	490 (70) min	22 min	Not Specified
<b>Typical Results</b> <sup>(3)</sup> - As-Welded Stress-Relieved 1 hr @ 620°C (1150°F)	440-510 (64-74)	540-580 (78-84)	25-30	35-43 (26-32)

## DEPOSIT COMPOSITION<sup>(1)</sup> – As Required per AWS A5.5

	%C	%Mn	%Si	%P	%S	%Mo
<b>Requirements</b> - AWS E7010-A1	0.12 max	0.60 max	0.40 max	0.03 max	0.03 max	0.40-0.65
<b>Typical Results</b> <sup>(3)</sup>	0.07-0.12	0.29-0.59	0.08-0.26	0.01-0.02	≤ 0.01	0.40-0.62

## TYPICAL OPERATING PROCEDURES

Polarity	Current (Amps)			
	3/32 in (2.4 mm)	1/8 in (3.2 mm)	5/32 in (4.0 mm)	3/16 in (4.8 mm)
DC+	50-90	75-130	90-175	140-225

<sup>(1)</sup>Typical all weld metal. <sup>(2)</sup>Measured with 0.2% offset. <sup>(3)</sup>See test results disclaimer

# SHIELD-ARC® 70+

Low Alloy, Cellulosic, Pipe ■ AWS E8010-G, Also meets E8010-P1

## KEY FEATURES

- Light slag for minimal arc interference
- Deep penetration
- Recommend to switch to Pipeliner® Arc 80 for superior puddle control and visibility

## TYPICAL APPLICATIONS

- Relatively high silicon pipe
- API 5L X56 through X70 grade pipe
- Cross country and in-plant pipe

## CONFORMANCES

<b>AWS A5:</b>	E8010-G E8010-P1
<b>ABS:</b>	E8010-G
<b>CWB/CSA:</b>	E5510-G

## WELDING POSITIONS

Vertical down recommended for pipe welding

## DIAMETERS / PACKAGING

Diameter in (mm)	Length in (mm)	50 lb (22.7 kg) Easy Open Can
1/8 (3.2)	14 (350)	ED012841
5/32 (4.0)	14 (350)	ED012849
3/16 (4.8)	14 (350)	ED012845

## MECHANICAL PROPERTIES<sup>(1)</sup> – As Required per AWS A5.5

	Yield Strength <sup>(2)</sup> MPa (ksi)	Tensile Strength MPa (ksi)	Elongation %	Charpy V-Notch J (ft·lbf)	
				@ -29°C (-20°F)	@ -46°C (-50°F)
<b>Requirements</b> - AWS E8010-G	460 (67) min	550 (80) min	19 min	Not Specified	Not Specified
<b>Typical Results</b> <sup>(3)</sup> - As-Welded	460-620 (67-90)	585-690 (85-100)	19-31	37-81 (27-60)	26-64 (19-47)

## DEPOSIT COMPOSITION<sup>(1)</sup> – As Required per AWS A5.5

	%C	%Mn <sup>(4)</sup>	%Si <sup>(4)</sup>	%P	%S
<b>Requirements</b> - AWS E8010-G	Not Specified	1.00 min.	0.80 min.	0.03 max.	0.03 max.
<b>Typical Results</b> <sup>(3)</sup>	0.13-0.17	0.60-1.20	0.05-0.30	≤ 0.01	≤ 0.01
	%Ni <sup>(4)</sup>	%Cr <sup>(4)</sup>	%Mo <sup>(4)</sup>	%V <sup>(4)</sup>	
<b>Requirements</b> - AWS E8010-G	0.50 min.	0.30 min.	0.20 min.	0.10 min.	
<b>Typical Results</b> <sup>(3)</sup>	0.75-0.97	0.01-0.20	0.35-0.45	0.02-0.04	

## TYPICAL OPERATING PROCEDURES

Polarity	Current (Amps)		
	1/8 in (3.2 mm)	5/32 in (4.0 mm)	3/16 in (4.8 mm)
DC+	75-130	90-185	140-225

<sup>(1)</sup>Typical all weld metal. <sup>(2)</sup>Measured with 0.2% offset. <sup>(3)</sup>See test results disclaimer <sup>(4)</sup>In order to meet the alloy requirements of the "G" designation, the undiluted weld metal shall have the minimum of at least one of the elements listed.

# SHIELD-ARC® 90

Low Alloy, Cellulosic, Pipe ▪ AWS E9010-G

## KEY FEATURES

- Light slag for minimal arc interference
- Deep penetration

## TYPICAL APPLICATIONS

- Hot pass welding of up to X80 grade pipe, when followed by low hydrogen fill and cap
- API 5L X70 through X80 grade pipe
- Cross country pipe

## CONFORMANCES

AWS A5: E9010-G

## WELDING POSITIONS

All

## DIAMETERS / PACKAGING

Diameter mm (in)	Length in (mm)	50 lb (22.7 kg) Easy Open Can
3.2 (1/8)	14 (350)	EDS01693
4.0 (5/32)	14 (350)	EDS01694
5.0 (3/16)	14 (350)	EDS01695

## MECHANICAL PROPERTIES<sup>(1)</sup> – As Required per AWS A5.5

	Yield Strength <sup>(2)</sup> MPa (ksi)	Tensile Strength MPa (ksi)	Elongation %	Charpy V-Notch J (ft•lbf)	
				@ -29°C (-20°F)	@ -46°C (-50°F)
<b>Requirements</b> - AWS E9010-G	530 (77) min	620 (90) min	17 min.	Not Specified	Not Specified
<b>Typical Results</b> <sup>(3)</sup> - As-Welded	530-605 (77-88)	620-690 (90-100)	17-29	45-94 (33-69)	28-62 (21-46)

## DEPOSIT COMPOSITION<sup>(1)</sup> – As Required per AWS A5.5

	%C	%Mn <sup>(4)</sup>	%Si <sup>(4)</sup>	%P	%S
<b>Requirements</b> - AWS E9010-G	Not Specified	1.00 min	0.80 min	0.03 max	0.03 max
<b>Typical Results</b> <sup>(3)</sup>	0.13-0.18	0.55-0.79	0.08-0.22	0.01-0.02	≤ 0.01
	%Ni <sup>(4)</sup>	%Cr <sup>(4)</sup>	%Mo <sup>(4)</sup>	%V <sup>(4)</sup>	
<b>Requirements</b> - AWS E9010-G	0.50 min	0.30 min	0.20 min	0.10 min	
<b>Typical Results</b> <sup>(3)</sup>	0.66-0.77	0.01-0.06	0.43-0.70	≤ 0.01	

## TYPICAL OPERATING PROCEDURES

Polarity	Current (Amps)		
	3.2 mm (1/8 in)	4.0 mm (5/32 in)	4.8 mm (3/16 in)
DC+	75-130	80-185	140-225

<sup>(1)</sup>Typical all weld metal. <sup>(2)</sup>Measured with 0.2% offset. <sup>(3)</sup>See test results disclaimer <sup>(4)</sup>In order to meet the alloy requirements of the "G" designation, the undiluted weld metal shall have the minimum of at least one of the elements listed.

# EXCALIBUR® 7018-A1 MR®

Low Alloy, Low Hydrogen ■ AWS E7018-A1 H4R

## KEY FEATURES

- Premium arc performance
- Easy strike, re-strike and slag removal
- Designed for welding 0.50% molybdenum steel
- Square coating burn-off

## TYPICAL APPLICATIONS

- Fabrication and maintenance welding
- Pressure vessels and pressure piping
- Applications requiring stress-relieved conditions

## CONFORMANCES

<b>AWS A5:</b>	E7018-A1, E7018-A1 H4R
<b>ABS:</b>	E7018-A1 H4R
<b>CWB/CSA:</b>	E4918-A1-H4R

## WELDING POSITIONS

All, except vertical down

## DIAMETERS / PACKAGING

Diameter in (mm)	Length in (mm)	8 lb (3.6 kg) Easy Open Can 24 lb (10.9 kg) Master Carton	10 lb (4.5 kg) Easy Open Can 30 lb (13.6 kg) Master Carton	25 lb (11.3 kg) Easy Open Can	50 lb (22.7 kg) Easy Open Can
3/32 (2.4)	12 (300)	ED032893	ED032873	ED032875	ED032876 ED032877
1/8 (3.2)	14 (350)				
5/32 (4.0)	14 (350)				

## MECHANICAL PROPERTIES<sup>(1)</sup> – As Required per AWS A5.5

	Yield Strength <sup>(2)</sup> MPa (ksi)	Tensile Strength MPa (ksi)	Elongation %	Charpy V-Notch J (ft·lbf) @ -29°C (-20°F)
<b>Requirements</b> - AWS E7018-A1 H4R	390 (57) min	490 (70) min	22 min	Not Specified
<b>Typical Results<sup>(3)</sup></b> - Stress-Relieved 1 hr @ 620°C (1150°F)	470-500 (68-72)	565-585 (82-85)	25-32	60-130 (46-96)
Stress-Relieved 8 hrs @ 620°C (1150°F) <sup>(4)</sup>	450-485 (65-70)	545-570 (79-83)	27-32	50-107 (38-79)

## DEPOSIT COMPOSITION<sup>(1)</sup> – As Required per AWS A5.5

	%C	%Mn	%Si	%P
<b>Requirements</b> - AWS E7018-A1 H4R	0.12 max	0.90 max	0.80 max	0.03 max
<b>Typical Results<sup>(3)</sup></b>	0.04-0.06	0.55-0.80	0.35-0.55	≤ 0.01
	%S	%Mo	Diffusible Hydrogen (mL/100g weld metal)	
<b>Requirements</b> - AWS E7018-A1 H4R	0.03 max	0.40-0.65	4.0 max	
<b>Typical Results<sup>(3)</sup></b>	≤ 0.01	0.45-0.65	2-4	

## TYPICAL OPERATING PROCEDURES

Polarity <sup>(5)</sup>	Current (Amps)		
	3/32 in (2.4 mm)	1/8 in (3.2 mm)	5/32 in (4.0 mm)
DC+	60-110	85-160	110-210
AC	65-120	90-170	115-220

<sup>(1)</sup>Typical all weld metal. <sup>(2)</sup>Measured with 0.2% offset. <sup>(3)</sup>See test results disclaimer. <sup>(4)</sup>Industry Specific Data (Not AWS Requirement). <sup>(5)</sup>Preferred polarity is listed first.

# EXCALIBUR® 8018-B2 MR®

Low Alloy, Low Hydrogen ■ AWS E8018-B2 H4R

## KEY FEATURES

- Easy strike, re-strike and slag removal
- Designed for welding 1.25% chromium, 0.50% molybdenum steel
- Premium arc performance

## TYPICAL APPLICATIONS

- Power generation
- Chemical Processing Structure
- Process piping
- Applications requiring stress-relieved conditions

## CONFORMANCES

<b>AWS A5.5:</b>	E8018-B2 H4R
<b>ASME SFA-A5.5:</b>	E8018-B2 H4R
<b>CWB/CSA W48-06:</b>	E5518-B2

## WELDING POSITIONS

All, except vertical down

## DIAMETERS / PACKAGING

Diameter in (mm)	Length in (mm)	8 lb (3.6 kg) Easy Open Can 24 lb (10.9 kg) Master Carton	10 lb (4.5 kg) Easy Open Can 30 lb (13.6 kg) Master Carton	25 lb (11.3 kg) Easy Open Can	50 lb (22.7 kg) Easy Open Can
3/32 (2.4)	12 (300)	ED032878		ED032881	
1/8 (3.2)	14 (350)		ED032879		ED032882
5/32 (4.0)	14 (350)				ED032883

## MECHANICAL PROPERTIES<sup>(1)</sup> – As Required per AWS A5.5

	Yield Strength <sup>(2)</sup> MPa (ksi)	Tensile Strength MPa (ksi)	Elongation %	Charpy V-Notch J (ft•lbf) @ -29°C (-20°F)
<b>Requirements</b> - AWS E8018-B2 H4R	460 (67) min	550 (80) min	19 min	Not Specified
<b>Typical Results</b> <sup>(3)</sup>				
Stress-Relieved 1 hr @ 690°C (1275°F)	540-585 (78-85)	640-685 (93-99)	24-26	71-127 (52-94)
Stress-Relieved 8 hrs @ 690°C (1275°F) <sup>(4)</sup>	495-540 (72-78)	605-640 (88-93)	25-28	64-127 (47-83)

## DEPOSIT COMPOSITION<sup>(1)</sup> – As Required per AWS A5.5

	%C	%Mn	%Si	%P
<b>Requirements</b> - AWS E8018-B2 H4R	0.05-0.12	0.90 max	0.80 max	0.03 max
<b>Typical Results</b> <sup>(3)</sup>	0.08-0.11	0.65-0.80	0.35-0.55	≤ 0.02
	%S	%Cr	%Mo	Diffusible Hydrogen (mL/100g weld metal)
<b>Requirements</b> - AWS E8018-B2 H4R	0.03 max	1.00-1.50	0.40-0.65	4.0 max
<b>Typical Results</b> <sup>(3)</sup>	≤ 0.01	1.05-1.30	0.40-0.60	2-4

## TYPICAL OPERATING PROCEDURES

Polarity <sup>(5)</sup>	Current (Amps)		
	3/32 in (2.4 mm)	1/8 in (3.2 mm)	5/32 in (4.0 mm)
DC+	60-110	85-160	110-210
AC	65-120	90-170	115-220

<sup>(1)</sup>Typical all weld metal. <sup>(2)</sup>Measured with 0.2% offset. <sup>(3)</sup>See test results disclaimer <sup>(4)</sup>Industry Specific Data (Not AWS Requirement). <sup>(5)</sup>Preferred polarity is listed first.

# EXCALIBUR® 8018-C1 MR®

Low Alloy, Low Hydrogen ■ AWS E8018-C1 H4R

## KEY FEATURES

- Designed to produce a nominal 2.25% nickel deposit
- Premium arc performance
- Easy strike, re-strike and slag removal

## TYPICAL APPLICATIONS

- Low temperature applications
- Refrigerated ammonia tanks
- Liquefied gas storage, piping and transportation
- Weathering steels
- Applications requiring stress-relieved conditions

## CONFORMANCES

**AWS A5:** E8018-C1 H4R  
**CWB/CSA:** E5518-C1-H4

## WELDING POSITIONS

All, except vertical down

## DIAMETERS / PACKAGING

Diameter in (mm)	Length in (mm)	10 lb (4.5 kg) Easy Open Can 30 lb (13.6 kg) Master Carton	50 lb (22.7 kg) Easy Open Can
3/32 (2.4)	14 (350)	ED032596	ED030876
1/8 (3.2)	14 (350)	ED032597	ED030877
5/32 (4.0)	14 (350)		ED030878
3/16 (4.8)	14 (350)		ED030879
1/4 (6.4)	18 (450)		ED030880

## MECHANICAL PROPERTIES<sup>(1)</sup> – As Required per AWS A5.5

	Yield Strength <sup>(2)</sup> MPa (ksi)	Tensile Strength MPa (ksi)	Elongation %	Charpy V-Notch J (ft-lbf) @ -59°C (-75°F)
<b>Requirements</b> – AWS E8018-C1 H4R	460 (67) min	550 (80) min	19 min	20 (27) min
<b>Typical Results<sup>(3)</sup></b> Stress-Relieved 1 hr @ 610°C (1125°F)	460-525 (67-76)	565-615 (82-89)	24-32	79-129 (58-95)

## DEPOSIT COMPOSITION<sup>(1)</sup> – As Required per AWS A5.5

	%C	%Mn	%Si	%P
<b>Requirements</b> – AWS E8018-C1 H4R	0.12 max	1.25 max	0.80 max	0.03 max
<b>Typical Results<sup>(3)</sup></b> – As-Welded	0.05-0.09	0.89-1.25	0.17-0.53	≤ 0.02
	%S	%Ni	Diffusible Hydrogen (mL/100g weld deposit)	
<b>Requirements</b> – AWS E8018-C1 H4R	0.03 max	2.00-2.75	4.0 max	
<b>Typical Results<sup>(3)</sup></b> – As-Welded	≤ 0.01	2.00-2.58	1-3	

## TYPICAL OPERATING PROCEDURES

Polarity <sup>(5)</sup>	Current (Amps)					
	3/32 in (2.4 mm)	1/8 in (3.2 mm)	5/32 in (4.0 mm)	3/16 in (4.8 mm)	7/32 in (5.6 mm)	1/4 in (6.4 mm)
DC+	70-110	90-160	130-210	180-300	250-330	300-400
AC	80-120	100-160	140-210	200-300	270-370	325-430

<sup>(1)</sup>Typical all weld metal. <sup>(2)</sup>Measured with 0.2% offset. <sup>(3)</sup>See test results disclaimer <sup>(4)</sup>Preferred polarity is listed first.

# EXCALIBUR® 8018-C3 MR®

Low Alloy, Low Hydrogen ■ AWS E8018-C3 H4R



## KEY FEATURES

- Designed to produce a 1% nickel deposit
- Premium arc performance
- Easy strike and re-strike
- Effortless slag removal

## TYPICAL APPLICATIONS

- Shipbuilding
- Piping and gas storage tanks
- Weathering steels
- Cross country pipe repair

## CONFORMANCES

<b>AWS A5:</b>	E8018-C3 H4R
<b>ABS:</b>	E8018-C3 H4R
<b>CWB/CSA:</b>	E5518-C3-H4
<b>ISO:</b>	E5518-N2 A U H5

## WELDING POSITIONS

All, except vertical down

## DIAMETERS / PACKAGING

Diameter in (mm)	Length in (mm)	10 lb (4.5 kg) Easy Open Can 30 lb (13.6 kg) Master Carton	50 lb (22.7 kg) Easy Open Can
3/32 (2.4)	14 (350)	ED032599	ED030892, ED034039*
1/8 (3.2)	14 (350)	ED032600	ED030893, ED034040*
5/32 (4.0)	14 (350)		ED030894, ED034041*
3/16 (4.8)	14 (350)		ED030895, ED034042*
7/32 (5.6)	18 (450)		ED030897, ED034315*
1/4 (6.4)	18 (450)		ED030896

\*Buy America Product

## MECHANICAL PROPERTIES<sup>(1)</sup> – As Required per AWS A5.5

	Yield Strength <sup>(2)</sup> MPa (ksi)	Tensile Strength MPa (ksi)	Elongation %	Charpy V-Notch J (ft-lbf) @ -40°C (-40°F)
<b>Requirements</b> – AWS E8018-C3 H4R	470-550 (68-80)	550 (80) min	24 min	27 (20) min
<b>Typical Results<sup>(3)</sup></b> – As-Welded	505-590 (73-86)	550-675 (80-98)	24-32	81-163 (60-120)

## DEPOSIT COMPOSITION<sup>(1)</sup> – As Required per AWS A5.5

	%C	%Mn	%Si	%P	%S
<b>Requirements</b> – AWS E8018-C3 H4R	0.12 max.	0.40-1.25	0.80 max.	0.03 max	0.03 max
<b>Typical Results<sup>(3)</sup></b>	0.04-0.07	0.40-1.25	0.23-0.46	≤ 0.01	≤ 0.009
	%Ni	%Cr	%Mo	%V	Diffusible Hydrogen (mL/100g weld deposit)
<b>Requirements</b> – AWS E8018-C3 H4R	0.80-1.10	0.15 max	0.35 max	0.05 max	4.0 max
<b>Typical Results<sup>(3)</sup></b>	0.81-1.09	0.04-0.06	0.07-0.27	≤ 0.01	1-2

## TYPICAL OPERATING PROCEDURES

Polarity <sup>(4)</sup>	Current (Amps)					
	3/32 in (2.4 mm)	1/8 in (3.2 mm)	5/32 in (4.0 mm)	3/16 in (4.8 mm)	7/32 in (5.6 mm)	1/4 in (6.4 mm)
DC±	70-110	90-160	130-210	180-300	250-330	300-400
AC	80-120	100-160	140-210	200-300	270-370	325-425

<sup>(1)</sup>Typical all weld metal. <sup>(2)</sup>Measured with 0.2% offset. <sup>(3)</sup>See test results disclaimer <sup>(4)</sup>Preferred polarity is listed first.



# EXCALIBUR® 9018-B3 MR®

Low Alloy, Low Hydrogen ■ AWS E9018-B3 H4R

## KEY FEATURES

- Designed for all-position welding of 2.25% chromium, 1% molybdenum low alloy steels
- Premium arc performance
- Easy strike, re-strike and slag removal

## TYPICAL APPLICATIONS

- Power generation
- Applications requiring stress-relieved conditions
- Chemical Processing Structures
- Process piping

## CONFORMANCES

**AWS A5:** E9018-B3, E9018-B3 H4R  
**CWB/CSA:** E6218-B3

## WELDING POSITIONS

All, except vertical down

## DIAMETERS / PACKAGING

Diameter in (mm)	Length in (mm)	8 lb (3.6 kg) Easy Open Can 24 lb (10.9 kg) Master Carton	10 lb (4.5 kg) Easy Open Can 30 lb (13.6 kg) Master Carton	25 lb (11.3 kg) Easy Open Can	50 lb (22.7 kg) Easy Open Can
3/32 (2.4)	12 (300)	ED032884		ED032887	
1/8 (3.2)	14 (350)		ED032885		ED032888
5/32 (4.0)	14 (350)				ED032889

## MECHANICAL PROPERTIES<sup>(1)</sup> – As Required per AWS A5.5

	Yield Strength <sup>(2)</sup> MPa (ksi)	Tensile Strength MPa (ksi)	Elongation %	Charpy V-Notch J (ft·lbf) @ -40°C (-40°F)
<b>Requirements</b> - AWS E9018-B3 H4R	530 (77) min	620 (90) min	17 min	Not Specified
<b>Typical Results</b> <sup>(3)</sup>				
Stress-Relieved 1 hr @ 690°C (1275°F)	595-605 (86-88)	705-715 (102-104)	20-23	57-72 (42-53)
Stress-Relieved 8 hrs @ 690°C (1275°F) <sup>(4)</sup>	530-580 (77-84)	650-685 (94-99)	20-24	43-107 (32-79)

## DEPOSIT COMPOSITION<sup>(1)</sup> – As Required per AWS A5.5

	%C	%Mn	%Si	%P
<b>Requirements</b> - AWS E9018-B3 H4R	0.05-0.12	0.90 max	0.80 max	0.03 max
<b>Typical Results</b> <sup>(3)</sup>	0.07-0.1	0.65-0.79	0.39-0.49	≤0.01
	%S	%Cr	%Mo	Diffusible Hydrogen (mL/100g weld metal)
<b>Requirements</b> - AWS E9018-B3 H4R	0.03 max	2.00-2.50	0.90-1.20	4.0 max
<b>Typical Results</b> <sup>(3)</sup>	≤0.01	2.21-2.46	1.03-1.13	2-4

## TYPICAL OPERATING PROCEDURES

Polarity <sup>(5)</sup>	Current (Amps)		
	3/32 in (2.4 mm)	1/8 in (3.2 mm)	5/32 in (4.0 mm)
DC+	60-110	85-160	110-210
AC	65-120	90-170	115-220

<sup>(1)</sup>Typical all weld metal. <sup>(2)</sup>Measured with 0.2% offset. <sup>(3)</sup>See test results disclaimer <sup>(4)</sup>Industry Specific Data (Not AWS Requirement). <sup>(5)</sup>Preferred polarity is listed first.

# EXCALIBUR® 9018M MR®

Low Alloy, Low Hydrogen ■ AWS E9018M H4R

## KEY FEATURES

- Designed to produce weld deposits with 620 MPa (90 ksi) tensile strength
- Premium arc performance
- Easy strike and re-strike
- Effortless slag removal

## TYPICAL APPLICATIONS

- High strength steel, such as HY-80, HY-90 and ASTM A514
- Cross country pipe repair
- DC welding

## DIAMETERS / PACKAGING

Diameter in (mm)	Length in (mm)	10 lb (4.5 kg) Easy Open Can 30 lb (13.6 kg) Master Carton	50 lb (22.7 kg) Easy Open Can
3/32 (2.4)	14 (350)	ED032602	ED030868
1/8 (3.2)	14 (350)	ED032603	ED030869
5/32 (4.0)	14 (350)		ED030870
3/16 (4.8)	14 (350)		ED030871

## CONFORMANCES

<b>AWS A5:</b>	E9018M, E9018M H4R
<b>ABS:</b>	E9018M H4R
<b>CWB/CSA:</b>	E6218M-H4R E9018M H4R

## WELDING POSITIONS

All, except vertical down

## MECHANICAL PROPERTIES<sup>(1)</sup> – As Required per AWS A5.5

	Yield Strength <sup>(2)</sup> MPa (ksi)	Tensile Strength MPa (ksi)	Elongation %	Charpy V-Notch J (ft-lbf) @ -50°C (-60°F)
<b>Requirements</b> - AWS E9018M H4R	540-620 (78-90) min	620 (90) min	24 min	27 (20) min
<b>Typical Results<sup>(3)</sup></b> - As-Welded	540-620 (78-90)	620-705 (90-102)	24-37	27-122 (20-90)

## DEPOSIT COMPOSITION<sup>(1)</sup> – As Required per AWS A5.5

	%C	%Mn	%Si	%P	%S
<b>Requirements</b> - AWS E9018M H4R	0.10 max	0.60-1.25	0.80 max	0.03 max	0.03 max.
<b>Typical Results<sup>(3)</sup></b>	0.04-0.07	0.90-1.10	0.30-0.50	0.01-0.02	≤ 0.01
	%Ni	%Cr	%Mo	Diffusible Hydrogen (mL/100g weld deposit)	
<b>Requirements</b> - AWS E9018M H4R	1.40-1.80	0.15 max	0.35 max	4.0 max	
<b>Typical Results<sup>(3)</sup></b>	1.50-1.80	0.05-0.12	0.25-0.35	1-3	

## TYPICAL OPERATING PROCEDURES

Polarity	Current (Amps)			
	3/32 in (2.4 mm)	1/8 in (3.2 mm)	5/32 in (4.0 mm)	3/16 in (4.8 mm)
DC+	70-110	90-160	130-210	180-300

<sup>(1)</sup>Typical all weld metal. <sup>(2)</sup>Measured with 0.2% offset. <sup>(3)</sup>See test results disclaimer

# EXCALIBUR® 10018-D2 MR®

Low Alloy, Low Hydrogen ■ AWS E10018-D2 H4R

## KEY FEATURES

- Premium arc performance
- Q2 Lot® - Lot Controlled Chemistry and Mechanical Properties
- Easy strike and slag removal

## TYPICAL APPLICATIONS

- Offshore and subsea components
- Meets NACE MR0175/ISO15156-2
- Chromium-molybdenum and other low alloy steels, including AISI 4130, 4140, 8630 and ASTM A182 and A336 Grades F22
- Carbon-manganese and other low alloy steels
- Process piping

## CONFORMANCES

<b>AWS A5:</b>	E10018-D2 H4R
<b>ABS:</b>	3YQ620 H5
<b>CWB/CSA:</b>	E6918-D2
<b>DNV:</b>	3 Y62H5
<b>Lloyd's Register:</b>	3Y62M H5

## WELDING POSITIONS

All, except vertical down

## DIAMETERS / PACKAGING

Diameter in (mm)	Length in (mm)	25 lb (11.3 kg) Easy Open Can	50 lb (22.7 kg) Easy Open Can
3/32 (2.4)	12 (300)	ED033162	
1/8 (3.2)	14 (350)		ED033163
5/32 (4.0)	14 (350)		ED033164
3/16 (4.8)	14 (350)		ED033330
7/32 (5.6)	18 (450)		ED033331

## MECHANICAL PROPERTIES<sup>(1)</sup> – As Required per AWS A5.5

	Yield Strength <sup>(2)</sup> MPa (ksi)	Tensile Strength MPa (ksi)	Elongation %	Charpy V-Notch J (ft•lbf) @ -51°C (-60°F)	Hardness <sup>(4)</sup> HV <sub>10</sub>
<b>Requirements</b> - AWS E10018-D2 H4R	600 (87) min	690 (100) min	16 min	27 (20) min	Not Specified
<b>Typical Results<sup>(3)</sup></b> - Stress-Relieved 1 hr @ 620°C (1150°F)	650-715 (94-104)	725-780 (105-113)	22-25	56-69 (41-51)	219-242
<i>Welded on AISI 4130 Steel</i>					
<b>Typical Results<sup>(3)</sup></b> - Stress-Relieved 12 hrs @ 620°C (1150°F) <sup>(4)</sup>	560-580 (81-84)	650-675 (94-98)	24-25	47-68 (35-50)	210-214

## DEPOSIT COMPOSITION<sup>(1)</sup> – As Required per AWS A5.5

	%C	%Mn	%Si	%P
<b>Requirements</b> - AWS E10018-D2 H4R	0.15 max	1.65-2.00	0.80 max	0.03 max
<b>Typical Results<sup>(3)</sup></b>	0.08-0.12	1.69-1.91	0.35-0.49	0.01-0.02
	%S	%Ni	%Mo	Diffusible Hydrogen (mL/100g weld deposit)
<b>Requirements</b> - AWS E10018-D2 H4R	0.03 max	0.90 max	0.25-0.45	4.0 max
<b>Typical Results<sup>(3)</sup></b>	≤0.01	0.68-0.77	0.34-0.39	2-3

## TYPICAL OPERATING PROCEDURES

Polarity	Current (Amps)		
	3/32 in (2.4 mm)	1/8 in (3.2 mm)	5/32 in (4.0 mm)
DC+	60-110	85-160	110-210
AC	65-120	90-170	115-220

<sup>(1)</sup>Typical all weld metal. <sup>(2)</sup>Measured with 0.2% offset. <sup>(3)</sup>See test results disclaimer <sup>(4)</sup>Industry specific data, not required by AWS. <sup>(5)</sup>Preferred polarity is listed first.  
NOTE: Additional test data available upon request.

# EXCALIBUR® 11018M MR®

Low Alloy, Low Hydrogen ■ AWS E11018M H4R

## KEY FEATURES

- Premium arc performance
- Square coating burn-off
- Easy strike and easy slag removal

## TYPICAL APPLICATIONS

- Quenched and tempered steels, such as A514, A517 and A709
- Crane booms
- Trailer frames
- General fabrication of high strength steels

## CONFORMANCES

<b>AWS A5:</b>	E11018M-H4R
<b>ABS:</b>	4YQ690 H5 E11018M-H4R
<b>CWB/CSA:</b>	E11018M-H4R
<b>DNV:</b>	4 YM69H5

## WELDING POSITIONS

All, except vertical down

## DIAMETERS / PACKAGING

Diameter in (mm)	Length in (mm)	10 lb (4.5 kg) Easy Open Can 30 lb (13.6 kg) Master Carton	50 lb (22.7 kg) Easy Open Can
3/32 (2.4)	14 (350)		ED031975
1/8 (3.2)	14 (350)	ED032607	ED031976
5/32 (4.0)	14 (350)	ED032608	ED031977
3/16 (4.8)	14 (350)		ED031978

## MECHANICAL PROPERTIES<sup>(1)</sup> – As Required per AWS A5.5

	Yield Strength <sup>(2)</sup> MPa (ksi)	Tensile Strength MPa (ksi)	Elongation %	Charpy V-Notch J (ft-lbf) @ -50°C (-60°F)
<b>Requirements</b> – AWS E11018M H4R	680-760 (98-110)	760 (110) min	20 min	27 (20) min
<b>Typical Results<sup>(3)</sup></b> – As-Welded	690-758 (100-110)	765-807 (111-117)	20-26	76-103 (56-76)

## DEPOSIT COMPOSITION<sup>(1)</sup> – As Required per AWS A5.5

	%C	%Mn	%Si	%P	%S
<b>Requirements</b> – AWS E11018M H4R	0.10 max	1.30-1.80	0.60 max	0.03 max	0.03 max
<b>Typical Results<sup>(3)</sup></b>	0.04-0.05	1.55-1.80	0.40-0.55	≤ 0.02	0.01-0.03
	%Ni	%Cr	%Mo	Diffusible Hydrogen (mL/100g weld deposit)	
<b>Requirements</b> – AWS E11018M H4R	1.25-2.50	0.40 max	0.25-0.50	4.0 max	
<b>Typical Results<sup>(3)</sup></b>	2.0-2.5	0.02-0.20	0.40-0.50	1-4	

## TYPICAL OPERATING PROCEDURES

Polarity	Current (Amps)			
	3/32 in (2.4 mm)	1/8 in (3.2 mm)	5/32 in (4.0 mm)	3/16 in (4.8 mm)
DC+	70-110	90-160	130-210	180-300

<sup>(1)</sup>Typical all weld metal. <sup>(2)</sup>Measured with 0.2% offset. <sup>(3)</sup>See test results disclaimer

# CHROMET<sup>®</sup> 5

Low Alloy Steel ▪ AWS E8015-B6

## KEY FEATURES

- Moisture resistant coating provides low amounts of weld metal hydrogen levels for a superior weld
- Designed for high strength and improved corrosion resistance with hot hydrogen gas, super-heated steam, and Sulphur crude oils

## WELDING POSITIONS

All, except vertical down

## CONFORMANCES

<b>AWS 5.5:</b>	E8015-B6
<b>BS EN ISO 3580-A</b>	E CrMo5 B 3 2 H5
<b>BS EN ISO 3580-B</b>	E 6216-5Cm

## TYPICAL APPLICATIONS

- Piping
- Steam Generating Power Plant
- Pressure Vessels
- Oil Refineries

## DIAMETERS / PACKAGING

Diameter mm (in)	Length mm (in)	12.0 kg (26 lb) Carton	13.5 kg (30 lb) Carton	17.1 kg (38 lb) Carton	16.8 kg (37 lb) Carton
2.5 (3/32)	350 (13.78)	CHROMET5-25	CHROMET5-32	CHROMET5-40	CHROMET5-50
3.2 (1/8)	380 (14.96)				
4.0 (5/32)	450 (17.72)				
5.0 (3/16)	450 (17.72)				

## MECHANICAL PROPERTIES<sup>(1)</sup> – As Required per AWS A5.5

	Yield Strength <sup>(2)</sup> MPa (ksi)	Tensile Strength MPa (ksi)	Elongation %	Charpy V-Notch J (ft-lbf)		Hardness HV
				@20 °C (68 °F)	@-10 °C (14 °F)	
<b>Requirements</b> AWS E8015-B6	460 (67) min	550 (80) min	19	-	-	-
<b>Typical Performance<sup>(3)</sup></b> As-Welded	500 (73) min	610 (88) min	25	150	80	210

## DEPOSIT COMPOSITION<sup>(1)</sup> – As Required per AWS A5.5

	%C	%Mn	%Si	%S	%P
<b>Requirements</b> AWS E8015-B6	0.05-0.10	0.50-1.0	0.80 max	0.025 max	0.025 max
<b>Typical Performance<sup>(3)</sup></b>	0.06	0.8	0.40	0.01	0.015
	%Cr	%Ni	%Mo	%Cu	
<b>Requirements</b> AWS E8015-B6	4.0-6.0	0.40 max	0.45-0.65	0.3 max	
<b>Typical Performance<sup>(3)</sup></b>	5	0.2	0.55	0.05	

## TYPICAL OPERATING PROCEDURES

Polarity <sup>(4)</sup>	2.5 mm (3/32 in)	3.2 mm (1/8 in)	4.0 mm (5/32 in)	5.0 mm (3/16 in)
DC+	70-110	80-140	100-180	140-240

<sup>(1)</sup> Typical all weld metal <sup>(2)</sup> Measured with 0.2% offset <sup>(3)</sup> See test results disclaimer <sup>(4)</sup> Preferred polarity is listed first.

# CHROMET<sup>®</sup> 9

Low Alloy Steel ■ AWS E8015-B8 H4

## KEY FEATURES

- Designed for corrosion resistance in elevated temperatures up to 600 °C (1112 °F)
- Moisture resistant coating provides low amounts of weld metal hydrogen levels for a superior weld
- Smooth arc performance in all positions

## WELDING POSITIONS

All, except vertical down

## CONFORMANCES

<b>AWS 5.5:</b>	E8015-B8 H4
<b>BS EN ISO 3580-A</b>	E CrMo9 B 3 2 H5
<b>BS EN ISO 3580-B</b>	E 6216-9C1M

## TYPICAL APPLICATIONS

- Oil Refineries
- Power Plants
- Piping
- Pressure Vessels
- Heat Exchangers

## DIAMETERS / PACKAGING

Diameter mm (in)	Length mm (in)	11.7 kg (26 lb) Carton	13.5 kg (30 lb) Carton	17.4 kg (38 lb) Carton	16.5 kg (36 lb) Carton
2.5 (3/32)	350 (13.78)	CHROMET9-25	CHROMET9-32	CHROMET9-40	CHROMET9-50
3.2 (1/8)	380 (14.96)				
4.0 (5/32)	450 (17.72)				
5.0 (3/16)	450 (17.72)				

## MECHANICAL PROPERTIES<sup>(1)</sup> – As Required per AWS A5.5

	Yield Strength <sup>(2)</sup> MPa (ksi)	Tensile Strength MPa (ksi)	Elongation %	Charpy V-Notch J (ft-lbf)		Hardness HV
				@20 °C (68 °F)	@-10 °C (14 °F)	
<b>Requirements</b> AWS E8015-B8 H4	460 (67) min	590 (86) min	19 min	34 min	-	-
<b>Typical Performance<sup>(3)</sup></b> After 2 hours of PWHT at 720 °C (1330 °F)	600 (87)	710 (103)	22	90	25	235

## DEPOSIT COMPOSITION<sup>(1)</sup> – As Required per AWS A5.5

	%C	%Mn	%Si	%S	%P
<b>Requirements</b> AWS E8015-B8 H4	0.05-0.10	0.50-1.0	0.60 max	0.025 max	0.025 max
<b>Typical Performance<sup>(3)</sup></b>	0.06	0.75	0.35	0.012	0.015
	%Cr	%Ni	%Mo	%Cu	
<b>Requirements</b> AWS E8015-B8 H4	8.0-10.0	0.40 max	0.90-1.20	0.3 max	
<b>Typical Performance<sup>(3)</sup></b>	9	0.2	1	<0.05	

## TYPICAL OPERATING PROCEDURES

Polarity <sup>(4)</sup>	2.5 mm (3/32 in)	3.2 mm (1/8 in)	4.0 mm (5/32 in)	5.0 mm (3/16 in)
DC+	70-110	80-140	100-180	140-240

<sup>(1)</sup> Typical all weld metal <sup>(2)</sup> Measured with 0.2% offset <sup>(3)</sup> See test results disclaimer <sup>(4)</sup> Preferred polarity is listed first.

# CHROMET® 9-B9

Low Alloy, Low Hydrogen ■ AWS E9015-B91 H4

## KEY FEATURES

- Improved long term creep properties
- Can weld equivalent (P91) 9CrMo steels
- Designed to weld the modified steels T91, P91 or Grade 91, which are designed to provide improved creep strength
- Meets current EPRI recommendation of %Ni + %Mn < 1.0%

## WELDING POSITIONS

All

## CONFORMANCES

**AWS A5.5:** E9015-B91 H4

**EN ISO 3580-B** E 6216-9C1MV

## TYPICAL APPLICATIONS

- Intended for high integrity structural service at elevated temperature
- Main Steam Piping
- Power Plants
- Oil Refineries
- Coal Liquefaction Plants
- Gasification Plants

## DIAMETERS / PACKAGING

Diameter mm (in)	4.5 kg (10 lb) Easy Open Can	5 kg (11 lb) Easy Open Can	5.5 kg (12 lb) Easy Open Can
2.5 (3/32)	CH9B9-25		
3.2 (1/8)	CH9B9-32		
4.0 (5/32)		CH9B9-40	
5.0 (3/16)			CH9B9-50

## MECHANICAL PROPERTIES<sup>(1)</sup> - As Required per AWS A5.5

	Yield Strength <sup>(2)</sup> MPa (ksi)	Tensile Strength MPa (ksi)	Elongation %	Charpy V-Notch J (ft·lbf) @ 20°C (68°F)	Hardness HV10 <sup>(4)</sup> @ PWHT
<b>Requirements</b> - AWS E9015-B91 H4	530 (77) min	620 (90) min	17 min	–	–
<b>Typical Results<sup>(3)</sup></b> Room Temperature PWHT 2 hr @ 760°C (1400°F)	590 (86)	710 (103)	22.5	75 (55)	240
High Temperature 550°C (1022°F)	>360 (52)	>450 (65)	–	–	–
600°C (1112°F)	>255 (37)	>375 (54)	–	–	–
650°C (1202°F)	>175 (25)	>285 (41)	–	–	–

## DEPOSIT COMPOSITION<sup>(1)</sup> - As Required per AWS A5.5

	%C	%Mn <sup>(5)</sup>	%Si <sup>(5)</sup>	%S	%P	%Cr
<b>Requirements</b> - AWS E9015-B91 H4	0.08 - 0.12	0.40 - 0.75	0.30 max	0.01 max	0.01 max	8.0 - 10.0
<b>Typical Results<sup>(3)</sup></b>	0.10	0.55	0.25	0.008	0.008	9.0
	%Ni <sup>(5)</sup>	%Mo	%Nb	%V	%Cu	%Al
<b>Requirements</b> - AWS E9015-B91 H4	0.2 - 0.4	0.85 - 1.2	0.03 - 0.07	0.15 - 0.25	0.25 max	0.04 max
<b>Typical Results<sup>(3)</sup></b>	0.3	1.0	0.04	0.20	0.05	<0.01

## TYPICAL OPERATING PROCEDURES

Polarity	Amperage mm (in)			
	2.5 (3/32)	3.2 (1/8)	4.0 (5/32)	5.0 (0.19)
DC+	70 - 110	80 - 140	100 - 180	140 - 240
AC	70 - 110	80 - 140	100 - 180	140 - 240

<sup>(1)</sup>Typical all weld metal. <sup>(2)</sup>Measured with 0.2% offset. <sup>(3)</sup>See test results disclaimer <sup>(4)</sup>Industry specific data, not required by AWS.

<sup>(5)</sup>Ni + Mn < 1.0%. Nickel is below 0.4% (as parent metal) although AWS allows up to 1.0%Ni. See Chromet 9MV-N or Chromet 9MVN+ for variant with 0.4 - 1.0%Ni conforming to EN ISO specification.

NOTE: Additional test data available upon request.

# CHROMET® 9MV-N

Low Alloy Steel ▪ AWS E9015-B91

## KEY FEATURES

- Developed with additional amounts of niobium, vanadium, and nitrogen to improve toughness and long term creep resistance
- Designed to provide creep resistance in high integrity structural services with elevated temperatures

## WELDING POSITIONS

All, except vertical down

## CONFORMANCES

**AWS 5.5:** E9015-B9 H4  
**BS EN ISO 3580-A** E CrMo91 B 3 2

## TYPICAL APPLICATIONS

- Power Generating Plants
- Main Steam Piping
- Turbine Casting
- Oil Refineries
- Coal Liquefaction and Gasification Plants

## DIAMETERS / PACKAGING

Diameter mm (in)	Length mm (in)	14.1 kg (31.1 lb) Carton	15.0 kg (33 lb) Carton	17.4 kg (38 lb) Carton	16.5 kg (36 lb) Carton
2.5 (3/32)	350 (13.78)	CH9MVN-25	CH9MVN-32	CH9MVN-40	CH9MVN-50
3.2 (1/8)	380 (14.96)				
4.0 (5/32)	450 (17.72)				
5.0 (3/16)	450 (17.72)				

## MECHANICAL PROPERTIES<sup>(1)</sup> – As Required per AWS A5.5

	Yield Strength <sup>(2)</sup> MPa (ksi)	Tensile Strength MPa (ksi)	Elongation %	Lateral Expansion mm (mils)	Charpy V-Notch J (ft•lbf) @20°C (68°F)	Hardness After PWHT	Hardness As Welded
<b>Requirements</b> AWS E9015-B9 H4	530 (77) min	620 (90) min	17 min	-	47	-	-
<b>Typical Performance<sup>(3)</sup></b> After 2 hours PWHT at 760°C (1400°F)	640 (93)	720 (104)	22	1.0	65	250	450

## DEPOSIT COMPOSITION<sup>(1)</sup> – As Required per AWS A5.5

	%C	%Mn	%Si	%S	%P	%Cr	%Ni
<b>Requirements</b> AWS E9015-B9 H4	0.08-0.12	0.50-1.20	0.30 max	0.01 max	0.01 max	8.0-10.0	0.4-0.8
<b>Typical Performance<sup>(3)</sup></b>	0.1	0.6	0.25	0.008	0.01	9	0.7
	%Mo	%Cu	%N	%Nb	%V	%SN	Ni+Mn
<b>Requirements</b> AWS E9015-B9 H4	0.85-1.2	0.25 max	0.03-0.07	0.04-0.07	0.15-0.25	<0.008 max	1.5 max
<b>Typical Performance<sup>(3)</sup></b>	1	0.05	0.05	0.05	0.2	0.003	1.3

## TYPICAL OPERATING PROCEDURES

Polarity <sup>(4)</sup>	2.5 mm (3/32 in)	3.2 mm (1/8 in)	4.0 mm (5/32 in)	5.0 mm (3/16 in)
DC+	70-110	80-140	100-180	140-240

<sup>(1)</sup> Typical all weld metal <sup>(2)</sup> Measured with 0.2% offset <sup>(3)</sup> See test results disclaimer <sup>(4)</sup> Preferred polarity is listed first.



# E9018-D1

Low Alloy Steel ▪ AWS E9018-D1

## KEY FEATURES

- Moisture resistant coating provides low amount of weld metal hydrogen levels for a superior weld
- Developed to resist sulphide-induced stress corrosion cracking
- Improved sub-zero toughness

## WELDING POSITIONS

All, except vertical down

## CONFORMANCES

**AWS 5.5:** E9018-D1  
**BS 2493:** MnMoBH

## TYPICAL APPLICATIONS

- Offshore Oil Pipework
- Fittings

## DIAMETERS / PACKAGING

Diameter mm (in)	Length mm (in)	12.0 kg (26 lb) Carton	13.8 kg (30 lb) Carton	15.9 kg (35 lb) Carton	16.8 kg (37 lb) Carton
2.5 (3/32)	350 (13.78)	E9018D1-25	E9018D1-32	E9018D1-40	E9018D1-50
3.2 (1/8)	380 (14.96)				
4.0 (5/32)	450 (17.72)				
5.0 (3/16)	450 (17.72)				

## MECHANICAL PROPERTIES<sup>(1)</sup> – As Required per AWS A5.5

	Yield Strength <sup>(2)</sup> MPa (ksi)	Tensile Strength MPa (ksi)	Elongation %	Charpy V-Notch J (ft-lbf)		Hardness HV
				@-30°C (-22°F)	@-50°C (-58°F)	
<b>Requirements</b> AWS E9018-D1	550 (80) min	630 (91) min	17 min	47 min	30 min	-
<b>Typical Performance<sup>(3)</sup></b> As-Welded	605 (88)	670 (97)	25	90	55	210

## DEPOSIT COMPOSITION<sup>(1)</sup> – As Required per AWS A5.5

	%C	%Mn	%Si	%S	%P
<b>Requirements</b> AWS E9018-D1	0.10 max	1.25-1.75	0.80 max	0.025 max	0.025 max
<b>Typical Performance<sup>(3)</sup></b>	0.07	1.5	0.4	0.01	0.015
	%Cr	%Ni	%Mo	%Cu	
<b>Requirements</b> AWS E9018-D1	-	-	0.25-0.45	-	
<b>Typical Performance<sup>(3)</sup></b>	0.15	0.15	0.35	0.05	

## TYPICAL OPERATING PROCEDURES

Polarity <sup>(4)</sup>	Amperage			
	2.5 mm (3/32 in)	3.2 mm (1/8 in)	4.0 mm (5/32 in)	5.0 mm (3/16 in)
DC+	70-110	80-140	100-180	140-240

<sup>(1)</sup> Typical all weld metal <sup>(2)</sup> Measured with 0.2% offset <sup>(3)</sup> See test results disclaimer <sup>(4)</sup> Preferred polarity is listed first.

**MIG & TIG***MIG (GMAW) Wire***Mild Steel, Non-Copper Coated**

SuperGlide® S3 .....	B-1
SuperGlide® S6 .....	B-3

**Mild Steel, Copper Coated**

SuperArc® L-50® .....	B-5
SuperArc® L-52® .....	B-7
SuperArc® L-56® .....	B-9
SuperArc® L-59® .....	B-11
SuperArc G4Si1 .....	B-13
Murematic® S3 .....	B-15
Murematic® S4+ .....	B-16
Murematic® S6 .....	B-17

**Low Alloy Steel**

1CrMo .....	B-18
2CrMo .....	B-19
ER90S-B3 .....	B-21
Techalloy® 4130 .....	B-22

**Low Alloy, Copper Coated**

SuperArc® LA-75™ .....	B-23
SuperArc® LA-90™ .....	B-25
SuperArc® LA-100™ .....	B-27
SuperArc® AK-10® .....	B-29

**Copper Alloys**

SuperGlaze™ SiBR .....	B-31
------------------------	------

*TIG (GTAW) Cut Length***Low Alloy Steel**

2Ni .....	B-32
5CrMo .....	B-33
9CrMoV-N .....	B-34
Lincoln® AK-10® .....	B-35
Lincoln® ER80S-B2 .....	B-36
Lincoln® ER80S-D2 .....	B-37
Lincoln® ER80S-Ni1 .....	B-38
Lincoln® ER90S-B3 .....	B-39
Lincoln® LA-84 .....	B-40
Techalloy® 4130 .....	B-41

**Mild Steel, Copper Coated**

Lincoln® ER70S-2 .....	B-42
Lincoln® ER70S-6 .....	B-43

# SUPERGLIDE® S3

Mild Steel, Non-Copper Coated Wire ■ AWS ER70S-3

## KEY FEATURES

- Moderate levels of manganese and silicon for deoxidization of clean to light mill scale surfaces
- MicroGuard® Ultra provides superior feeding and arc stability
- Supports short-circuiting, globular, axial spray and pulsed spray transfer
- Non-copper coated

## WELDING POSITIONS

All

## SHIELDING GAS

100% CO<sub>2</sub>  
 75-95% Argon / Balance CO<sub>2</sub>  
 95-98% Argon / Balance O<sub>2</sub>  
 Flow Rate: 30-50 CFH

## CONFORMANCES

**AWS A5:** ER70S-3  
**CWB/CSA:** B-G 49A 2 C1 S3  
**ISO:** G 49A 2 C1 S3

## TYPICAL APPLICATIONS

- Clean to light mill scale base material
- Sheet metal to 380-485 MPa (55-70 ksi) yield strength material
- Pipeline
- Pressure vessels
- Structural steel

## DIAMETERS / PACKAGING

Diameter in (mm)	44 lb (20 kg) Fiber Spool	500 lb (227 kg) Accu-Trak® Drum
0.035 (0.9)	ED028621	ED030772
0.045 (1.1)	ED028622	ED030773

## MECHANICAL PROPERTIES<sup>(1)</sup> – As Required per AWS A5.18

	Yield Strength <sup>(2)</sup> MPa (ksi)	Tensile Strength MPa (ksi)	Elongation %	Charpy V-Notch J (ft·lbf)	
				@ -18°C (0°F)	@ -29°C (-20°F)
<b>Requirements</b> - AWS ER70S-3 As-Welded with 100% CO <sub>2</sub>	400 (58) min	485 (70) min	22 min	27 (20) min	Not Specified
<b>Typical Results</b> <sup>(3)</sup> - As-Welded with 100% CO <sub>2</sub>	405 (59)	510 (74)	26	100 (74)	87 (64)

**WIRE COMPOSITION – As Required per AWS A5.18**

	%C	%Mn	%Si	%S	%P
<b>Requirements - AWS ER70S-3</b>	0.006-0.15	0.90-1.40	0.45-0.75	0.035 max	0.025 max
<b>Typical Results<sup>(3)</sup></b>	0.07-0.10	1.15-1.27	0.52-0.59	0.002-0.008	0.005-0.013
	%Cr	%Mo	%Ni	%V	%Cu
<b>Requirements - AWS ER70S-3</b>	0.15 max	0.15 max	0.15 max	0.03 max	0.50 max
<b>Typical Results<sup>(3)</sup></b>	≤ 0.03	≤ 0.01	≤ 0.04	< 0.01	0.02-0.04

**TYPICAL OPERATING PROCEDURES**

Diameter, Polarity Shielding Gas	CTWD <sup>(4)</sup> mm (in)	Wire Feed Speed m/min (in/min)	Voltage (volts)	Approx. Current (amps)	Melt-Off Rate kg/hr (lb/hr)
<b>0.035 in (0.9 mm), DC+</b>					
Short Circuit Transfer 100% CO <sub>2</sub> <sup>(5)</sup>	9-12 (3/8-1/2)	2.5 (100)	18	80	0.7 (1.6)
		3.8 (150)	19	120	1.1 (2.4)
		6.4 (250)	22	175	1.8 (4.0)
Spray Transfer 90% Ar/10% CO <sub>2</sub>	12-19 (1/2-3/4)	9.5 (375)	23	195	2.7 (6.0)
		12.7 (500)	29	230	3.6 (8.0)
		15.2 (600)	30	275	4.4 (9.6)
<b>0.045 in (1.1 mm), DC+</b>					
Short Circuit Transfer 100% CO <sub>2</sub> <sup>(5)</sup>	12-19 (1/2-3/4)	3.2 (125)	19	145	1.5 (3.4)
		3.8 (150)	20	165	1.8 (4.0)
		5.1 (200)	21	200	2.4 (5.4)
Spray Transfer 90% Ar/10% CO <sub>2</sub>	12-19 (1/2-3/4)	8.9 (350)	27	285	4.2 (9.2)
		12.1 (475)	30	335	5.7 (12.5)
		12.7 (500)	30	340	6.0 (13.2)

<sup>(1)</sup>Typical all weld metal. <sup>(2)</sup>Measured with 0.2% offset. <sup>(3)</sup>See test results disclaimer. <sup>(4)</sup>CTWD (Contact Tip to Work Distance). Subtract 1/4 in (6.4 mm) to calculate Electrical Stickout.  
<sup>(5)</sup>Procedures in these areas are procedures for short circuiting mode using 100% CO<sub>2</sub>. When using 75% Argon, 25% CO<sub>2</sub> for short circuit transfer, reduce voltage by 1 to 2 volts.

# SUPERGLIDE® S6

Mild Steel, Non-Copper Coated Wire ■ AWS ER70S-6

## KEY FEATURES

- High levels of manganese and silicon deoxidizers tolerate medium to heavy mill scale surfaces
- MicroGuard® Ultra provides superior feeding and arc stability
- Supports short-circuiting, globular, axial spray and pulsed spray transfer
- Non-copper coated

## WELDING POSITIONS

All

## SHIELDING GAS

100% CO<sub>2</sub>  
 75-95% Argon / Balance CO<sub>2</sub>  
 95-98% Argon / Balance O<sub>2</sub>  
 Flow Rate: 30 - 50 CFH

## CONFORMANCES

**AWS A5:** ER70S-6  
**CWB/CSA:** B-G 49A 3 C1 S6  
**ISO:** G 49A 3 C1 S6

## TYPICAL APPLICATIONS

- Medium to heavy mill scale base material
- Sheet metal to 380 - 485 MPa (55 - 70 ksi) yield strength material
- Automotive repair
- Structural steel

## DIAMETERS / PACKAGING

Diameter in (mm)	44 lb (20 kg) Fiber Spool	500 lb (227 kg) Accu-Trak® Drum	900 lb (408 kg) Accu-Trak® Drum
0.035 (0.9)	ED028635		ED034560
0.045 (1.1)	ED028636	ED030695	ED034561

## MECHANICAL PROPERTIES<sup>(1)</sup> – As Required per AWS A5.18

	Yield Strength <sup>(2)</sup> MPa (ksi)	Tensile Strength MPa (ksi)	Elongation %	Charpy V-Notch J (ft·lbf) @ -29°C (-20°F)
<b>Requirements</b> - AWS ER70S-6 As-Welded with 100% CO <sub>2</sub>	400 (58) min	485 (70) min	22 min	27 (20) min
<b>Typical Results</b> <sup>(3)</sup> - As-Welded with 100% CO <sub>2</sub>	430 (62)	540 (78)	28	71 (52)

**WIRE COMPOSITION – As Required per AWS A5.18**

	%C	%Mn	%Si	%S	%P
<b>Requirements - AWS ER70S-6</b>	0.06-0.15	1.40-1.85	0.80-1.15	0.035 max	0.025 max
<b>Typical Results<sup>(3)</sup></b>	0.08-0.09	1.42-1.65	0.81-0.87	0.006-0.010	0.004-0.010
	%Cr	%Ni	%Mo	%V	%Cu (Total)
<b>Requirements - AWS ER70S-6</b>	0.15 max	0.15 max	0.15 max	0.03 max	0.50 max
<b>Typical Results<sup>(3)</sup></b>	0.01-0.05	≤ 0.04	≤ 0.01	< 0.01	0.01-0.04

**TYPICAL OPERATING PROCEDURES**

Diameter, Polarity Shielding Gas	CTWD <sup>(4)</sup> mm (in)	Wire Feed Speed m/min (in/min)	Voltage (volts)	Approx. Current (amps)	Melt-Off Rate kg/hr (lb/hr)
<b>0.035 in (0.9 mm), DC+</b>					
Short Circuit Transfer 100% CO <sub>2</sub> <sup>(5)</sup>	9-12 (3/8-1/2)	2.5 (100)	18	80	0.7 (1.6)
		3.8 (150)	19	120	1.1 (2.4)
		6.4 (250)	22	175	1.8 (4.0)
Spray Transfer 90% Ar/10% CO <sub>2</sub>	12-19 (1/2-3/4)	9.5 (375)	23	195	2.7 (6.0)
		12.7 (500)	29	230	3.6 (8.0)
		15.2 (600)	30	275	4.4 (9.6)
<b>0.045 in (1.1 mm), DC+</b>					
Short Circuit Transfer 100% CO <sub>2</sub> <sup>(5)</sup>	12-19 (1/2-3/4)	3.2 (125)	19	145	1.5 (3.4)
		3.8 (150)	20	165	1.8 (4.0)
		5.1 (200)	21	200	2.4 (5.4)
Spray Transfer 90% Ar/10% CO <sub>2</sub>	12-19 (1/2-3/4)	8.9 (350)	27	285	4.2 (9.2)
		12.1 (475)	30	335	5.7 (12.5)
		12.7 (500)	30	340	6.0 (13.2)

<sup>(1)</sup>Typical all weld metal. <sup>(2)</sup>Measured with 0.2% offset. <sup>(3)</sup>See test results disclaimer. <sup>(4)</sup>CTWD (Contact Tip to Work Distance). Subtract 1/4 in (6.4 mm) to calculate Electrical Stickout.

<sup>(5)</sup>Procedures in these areas are procedures for short circuiting mode using 100% CO<sub>2</sub>. When using 75% Argon, 25% CO<sub>2</sub> for short circuit transfer, reduce voltage by 1 to 2 volts.

# SUPERARC® L-50®

Mild Steel, Copper Coated ■ AWS ER70S-3 & EM13K



## KEY FEATURES

- Moderate levels of manganese and silicon for deoxidization of clean to light mill scale surfaces
- Copper coating provides superior arc-starting characteristics for long contact tip life
- Supports short-circuiting, globular, axial spray and pulsed spray transfer
- MicroGuard® Ultra provides superior feeding and arc stability

## WELDING POSITIONS

All

## SHIELDING GAS

100% CO<sub>2</sub>

75-95% Argon / Balance CO<sub>2</sub>

95-98% Argon / Balance O<sub>2</sub>

Flow Rate: 30-50 CFH

## CONFORMANCES

<b>AWS A5:</b>	ER70S-3
<b>ABS:</b>	3YSA H5
<b>CWB/CSA:</b>	B-G 49A 3 C1 S3
<b>DNV:</b>	III YMS H5
<b>Lloyd's Register:</b>	3YS H5
<b>ISO:</b>	G 49A 2 C1 S3

## TYPICAL APPLICATIONS

- Clean to light mill scale base material
- Pipeline and processing pipe
- Sheet metal to 380 - 485 MPa (55 - 70 ksi) yield strength material
- Pressure vessels
- Structural steel

## DIAMETERS / PACKAGING

Diameter in (mm)	33 lb (15 kg) Plastic Spool	33 lb (15 kg) Steel Spool	44 lb (20 kg) Steel Spool	44 lb (20 kg) Fiber Spool	60 lb (27.2 kg) Coil
0.030 (0.8)	ED032923	ED031407			
0.035 (0.9)	ED032924	ED031408	ED031914	ED021268, ED036624*	
0.045 (1.1)	ED032925	ED031409, ED036879*	ED031915	ED021270, ED034428*	
0.052 (1.3)			ED031916		ED011317
1/16 (1.6)					
Diameter in (mm)	60 lb (27.2 kg) Fiber Spool	500 lb (227 kg) Accu-Trak® Drum	500 lb (227 kg) Accu-Pak® Box	500 lb (227 kg) Infinity-Pak®	600 lb (272 kg) Speed-Feed® Drum
0.030 (0.8)		ED029223			
0.035 (0.9)	ED021269	ED021052	ED032899		
0.040 (1.0)					
0.045 (1.1)	ED021271	ED020526	ED032901	ED034535	
0.052 (1.3)	ED021273	ED020527	ED032902		
1/16 (1.6)	ED027274		ED032903		ED011316
Diameter in (mm)	900 lb (408 kg) Accu-Pak® Box	1000 lb (454 kg) Accu-Trak® Drum	1000 lb (454 kg) Accu-Pak® Box	1000 lb (454 kg) Precise-Trak® Reel	1000 lb (454 kg) Infinity-Pak®
0.030 (0.8)					
0.035 (0.9)	ED032842	ED028825		ED032379	
0.040 (1.0)			ED033292	ED032380	
0.045 (1.1)		ED028826	ED032844	ED031614	ED031930
0.052 (1.3)		ED029082	ED032845	ED031615	ED034464
1/16 (1.6)		ED029083	ED032846	ED033270	

\*Buy America Product

**MECHANICAL PROPERTIES<sup>(1)</sup> – As Required per AWS A5.18**

	Yield Strength <sup>(2)</sup> MPa (ksi)	Tensile Strength MPa (ksi)	Elongation %	Charpy V-Notch - J (ft-lbf)	
				@ -18°C (0°F)	@ -29°C (-20°F)
<b>Requirements - AWS ER70S-3</b> As-Welded with 100% CO <sub>2</sub>	400 (58) min	485 (70) min	22 min	27 (20) min	Not Specified
MIL-70S-3 per MIL-E-23765/1 As-Welded with CO <sub>2</sub> and 98% Ar/2% O <sub>2</sub>	380-485 (55-70)	485 (70) min	22 min	Not Specified	Not Specified
<b>Typical Results<sup>(3)</sup></b> As-Welded with 100% CO <sub>2</sub> Stress Relieved 1 hr. @ 621°C (1150°F)	415 (60) 365 (53)	515 (75) 475 (69)	26 34	95 (70) 118 (87)	88 (65) 100 (74)
As-Welded with 75% Ar/25% CO <sub>2</sub> Stress Relieved 1 hr. @ 621°C (1150°F)	420 (61) 365 (53)	525 (76) 490 (71)	28 33	106 (78) 165 (122)	102 (75) 163 (120)
As-Welded with 90% Ar/10% CO <sub>2</sub> Stress Relieved 1 hr. @ 621°C (1150°F)	450 (65) 365 (53)	545 (79) 485 (70)	30 35	142 (105) –	122 (90) 214 (158)
As-Welded with 98% Ar/2% O <sub>2</sub> Stress Relieved 1 hr. @ 621°C (1150°F)	425 (62) 350 (51)	540 (78) 475 (69)	27 33	108 (80) –	95 (70) 339 (250)

**WIRE COMPOSITION – As Required per AWS A5.18**

	%C	%Mn	%Si	%S	%P
<b>Requirements - AWS ER70S-3</b>	0.006-0.15	0.90-1.40	0.45-0.75	0.035 max	0.025 max
<b>Typical Results<sup>(3)</sup></b>	0.08-0.11	1.14-1.23	0.53-0.59	0.003-0.009	0.003-0.013
	%Cr	%Mo	%Ni	%V	%Cu (Total) <sup>(4)</sup>
<b>Requirements - AWS ER70S-3</b>	0.15 max	0.15 max	0.15 max	0.03 max	0.50 max
<b>Typical Results<sup>(3)</sup></b>	≤ 0.04	≤ 0.02	≤ 0.03	< 0.01	0.15-0.25

**TYPICAL OPERATING PROCEDURES**

Diameter, Polarity Shielding Gas	CTWD <sup>(5)</sup> mm (in)	Wire Feed Speed m/min (in/min)	Voltage (volts)	Approx. Current (amps)	Melt-Off Rate kg/hr (lb/hr)
<b>0.030 in (0.8 mm), DC+</b>					
Short Circuit Transfer 100% CO <sub>2</sub>	9-12 (3/8-1/2)	1.9 (75)	17	35	0.4 (0.9)
		3.8 (150)	18	70	0.8 (1.8)
		7.6 (300)	22	130	1.6 (3.6)
<b>0.035 in (0.9 mm), DC+</b>					
Short Circuit Transfer 100% CO <sub>2</sub> <sup>(6)</sup>	9-12 (3/8-1/2)	2.5 (100)	18	80	0.7 (1.6)
		3.8 (150)	19	120	1.1 (2.4)
		6.4 (250)	22	175	1.8 (4.0)
Spray Transfer 90% Ar/10% CO <sub>2</sub>	12-19 (1/2-3/4)	9.5 (375)	23	195	2.7 (6.0)
		12.7 (500)	29	230	3.6 (8.0)
		15.2 (600)	30	275	4.4 (9.6)
<b>0.045 in (1.1 mm), DC+</b>					
Short Circuit Transfer 100% CO <sub>2</sub> <sup>(6)</sup>	12-19 (1/2-3/4)	3.2 (125)	19	145	1.5 (3.4)
		3.8 (150)	20	165	1.8 (4.0)
		5.1 (200)	21	200	2.5 (5.4)
Spray Transfer 90% Ar/10% CO <sub>2</sub>	12-19 (1/2-3/4)	8.9 (350)	27	285	4.2 (9.2)
		12.1 (475)	30	335	5.7 (12.5)
		12.7 (500)	30	340	6.0 (13.2)
<b>0.052 in (1.3 mm), DC+</b>					
Spray Transfer 90% Ar/10% CO <sub>2</sub>	12-19 (1/2-3/4)	7.6 (300)	30	300	4.8 (10.6)
		8.1 (320)	30	320	5.2 (11.5)
		12.3 (485)	32	430	7.8 (17.1)
<b>1/16 in (1.6 mm), DC+</b>					
Spray Transfer 90% Ar/10% CO <sub>2</sub>	12-25 (1/2-1)	5.3 (210)	25	325	4.8 (10.7)
		6.0 (235)	27	350	5.4 (12.0)
		7.4 (290)	28	430	6.7 (14.8)

<sup>(1)</sup>Typical all weld metal. <sup>(2)</sup>Measured with 0.2% offset. <sup>(3)</sup>See test results disclaimer. <sup>(4)</sup>Copper due to any coating on the electrode plus the copper content of the filler metal itself, shall not exceed the stated 0.50% max. <sup>(5)</sup>CTWD (Contact Tip to Work Distance). Subtract 1/4 in (6.4 mm) to calculate Electrical Stickout. <sup>(6)</sup>Procedures in these areas are procedures for short circuiting mode using 100% CO<sub>2</sub>. When using 75% Argon, 25% CO<sub>2</sub>, for short circuit transfer, reduce voltage by 1 to 2 volts.



# SUPERARC® L-52™

Mild Steel, Copper Coated ▪ AWS ER70S-2, ER70S-2

## KEY FEATURES

- Triple deoxidized (Aluminum, Titanium, Zirconium) ER70S-2 solid wire designed for welding over rust and mill scale without sacrificing weld quality
- Very low nitrogen in the steel to help achieve impact resistance above 70 ft•lbs @-20°F
- Microguard® Ultra provides superior feeding, arc stability and improved protection against corrosion
- Copper coating promotes excellent arc starting and extremely low contact tip wear.
- Very low spatter levels and fume emissions.
- Preferred for all position welding of different sizes of pipe.

## CONFORMANCES

AWS A5: ER70S-2

## TYPICAL APPLICATIONS

- Root, fill and cap pass welding for Piping industries
- Metal Fabrication
- Power Generation

## WELDING POSITIONS

All

## SHIELDING GAS

100% CO<sub>2</sub>  
75-95% Argon/ Balance CO<sub>2</sub>  
Flow Rate: 30-50 CFH

## DIAMETERS / PACKAGING

Diameter in (mm)	33 lb (15 kg) Steel Spool	44 lb (20 kg) Steel Spool
0.035 (0.9)	ED037003	ED037004
0.045 (1.1)	ED037005	ED037006

## MECHANICAL PROPERTIES<sup>(1)</sup> – As Required per AWS A5.18

	Yield Strength <sup>(2)</sup> MPa (ksi)	Tensile Strength MPa (ksi)	Elongation %	Charpy V-Notch - J (ft•lbf) @-30°C (-20°F)
<b>Requirements</b> - AWS ER70S-2 As-Welded with 100% CO <sub>2</sub>	400 (58) min	485 (70) min	22 min	27 (20) min
<b>Typical Results</b> <sup>(3)</sup> As-Welded with 100% CO <sub>2</sub>	440 (63)	520 (76)	30	129 (95)

<sup>(1)</sup>Typical all weld metal. <sup>(2)</sup>Measured with 0.2% offset.

**WIRE COMPOSITION<sup>(1)</sup> – As Required per AWS A5.18**

	%C	%Mn	%Si	%S	%P	%Cr	%Ni
<b>Requirements</b> - AWS ER70S-2	0.07 max	0.90-1.40	0.40-0.70	0.035 max	0.025 max	0.15 max	0.015 max
<b>Typical Results<sup>(3)</sup></b>	0.04	1.10	0.59	< 0.003	0.003	0.06	0.03
	%Mo	%V	%Ti	%Zr	%Al	%Cu (Total) <sup>(4)</sup>	
<b>Requirements</b> - AWS ER70S-2	0.15 max	0.03 max	0.05-0.15	0.02-0.12	0.05-0.15	0.50 max	
<b>Typical Results<sup>(3)</sup></b>	0.01	0.01	0.10	0.03	0.07	0.21	

**TYPICAL OPERATING PROCEDURES**

Diameter, Polarity Shielding Gas	CTWD <sup>(5)</sup> mm (in)	Wire Feed Speed m/min (in/min)	Voltage (volts)	Approx. Current (amps)	Melt-Off Rate kg/hr (lb/hr)
<b>0.035 in (0.9 mm), DC+</b> 100% CO <sub>2</sub>	12-19 (1/2-3/4)	5.6-19.8 (220-780)	19-31	105-320	1.6-5.7 (3.6-12.6)
<b>0.045 in (1.1 mm), DC+</b> 100% CO <sub>2</sub>	12-19 (1/2-3/4)	5.1-15.2 (200-600)	19-31	145-360	2.4-7.2 (5.3-15.9)

<sup>(1)</sup>Typical all weld metal. <sup>(2)</sup>Measured with 0.2% offset. <sup>(3)</sup>See test results disclaimer. <sup>(4)</sup>Copper due to any coating on the electrode plus the copper content of the filler metal itself, shall not exceed the stated 0.50% max. <sup>(5)</sup>CTWD (Contact Tip to Work Distance). Subtract 1/4 in (6.4 mm) to calculate Electrical Stickout.

# SUPERARC® L-56®

Mild Steel, Copper Coated ■ AWS ER70S-6 & EH11K



## KEY FEATURES

- High levels of manganese and silicon deoxidizers tolerate medium to heavy mill scale surfaces
- Excellent toe-wetting provides optimal bead appearance
- Copper coating provides superior arc-starting characteristics for long contact tip life
- Supports short-circuiting, globular, axial spray and pulsed spray transfer
- MicroGuard® Ultra provides superior feeding and arc stability

## TYPICAL APPLICATIONS

- Medium to heavy mill scale base material
- Sheet metal to 380-485 MPa (55-70 ksi) yield strength material
- Automotive repair
- Robotic or hard automation
- Structural steel
- Pressure vessels

## CONFORMANCES

<b>AWS A5:</b>	ER70S-6
<b>ABS:</b>	3YSA H5
<b>CWB/CSA:</b>	B-G 49A 3 C1 S6
<b>DNV:</b>	III YMS H5
<b>Lloyd's Register:</b>	3YS H5
<b>ISO:</b>	G 42 4 M20 3Si1 G 49A 3 C1 S6

## WELDING POSITIONS

All

## SHIELDING GAS

100% CO<sub>2</sub>  
75-95% Argon / Balance CO<sub>2</sub>

95-98% Argon / Balance O<sub>2</sub>  
Flow Rate: 30-50 CFH

## DIAMETERS / PACKAGING

Diameter in (mm)	2 lb (1 kg) Plastic Spool 10 lb (4.5 kg) Master Carton	12.5 lb (5.7 kg) Plastic Spool	33 lb (15 kg) Plastic Spool	33 lb (15 kg) Steel Spool	44 lb (20 kg) Steel Spool
0.025 (0.6)	ED030583	ED015790			
0.030 (0.8)	ED030631	ED023334	ED032926		
0.035 (0.9)	ED030632	ED028676	ED032927	ED031411	ED025945
0.045 (1.1)		ED029042	ED032928	ED031412	ED025946
Diameter in (mm)	44 lb (20 kg) Fiber Spool	60 lb (27.2 kg) Coil	60 lb (27.2 kg) Fiber Spool	250 lb (113.4 kg) Accu-Trak® Drum	
0.030 (0.8)			ED021275	ED029914	
0.035 (0.9)	ED021274, ED033704*			ED029915	
0.040 (1.0)	ED027384		ED021277, ED036730*	ED029916	
0.045 (1.1)	ED021276, ED033703*, ED033328**		ED021279		
0.052 (1.3)	ED021278, ED033705*				
1/16 (1.6)		ED011666, ED033710*			
Diameter in (mm)	500 lb (227 kg) Accu-Trak® Drum	500 lb (227 kg) Accu-Pak® Box	500 lb (227 kg) Infinity-Pak	1000 lb (454 kg) Infinity-Pak	
0.030 (0.8)	ED030771			ED036632	
0.035 (0.9)	ED021056	ED032904	ED034394	ED036633	
0.040 (1.0)	ED031937				
0.045 (1.1)	ED020532, ED036219**	ED032906, ED034248**			
0.052 (1.3)	ED020533	ED032907			
1/16 (1.6)	ED029225, ED033707*				
Diameter in (mm)	900 lb (408 kg) Accu-Pak® Box	1000 lb (454 kg) Accu-Trak® Drum	1000 lb (454 kg) Accu-Pak® Box	1000 lb (454 kg) Precise-Trak® Reel	
0.035 (0.9)	ED032847, ED034429*	ED028827		ED033271	
0.040 (1.0)		ED031032		ED031616	
0.045 (1.1)		ED028828	ED032849, ED033706*	ED031617	
0.052 (1.3)		ED029084	ED032850, ED033702*		
1/16 (1.6)		ED029085	ED032851		

\*Buy America Product \*\*Tested Material

**MECHANICAL PROPERTIES<sup>(1)</sup> – As Required per AWS A5.18**

	Yield Strength <sup>(2)</sup> MPa (ksi)	Tensile Strength MPa (ksi)	Elongation %	Charpy V-Notch J (ft·lbf)	
				@ -29°C (-20°F)	@ -40°C (-40°F)
<b>Requirements</b> - AWS ER70S-6 As-Welded with 100% CO <sub>2</sub>	400 (58) min	485 (70) min	22 min.	27 (20) min.	Not Specified
MIL-70S-6 per MIL-E-23765/1 As-Welded with CO <sub>2</sub> and 98% Ar/2% O <sub>2</sub>	380-550 (55-80)	485 (70) min	22 min	Not Specified	Not Specified
MIL-70S-6 per MIL-E-23765/1 Stress Relieved 1 hr. @ 621°C (1150°F) with CO <sub>2</sub> and 98% Ar/2% O <sub>2</sub>	360 (52) min	485 (70) min	26 min	27 (20) min	Not Specified
<b>Typical Results<sup>(3)</sup></b>					
As-Welded with 100% CO <sub>2</sub>	440 (64)	560 (81)	29	71 (52)	61 (45)
Stress Relieved 1 hr. @ 621°C (1150°F)	395 (57)	510 (74)	29	95 (70)	68 (50)
As-Welded with 75% Ar/25% CO <sub>2</sub>	460 (67)	565 (82)	27	82 (60)	72 (53)
Stress Relieved 1 hr. @ 621°C (1150°F)	415 (60)	540 (78)	31	140 (103)	122 (90)
As-Welded with 90% Ar/10% CO <sub>2</sub>	470 (68)	580 (84)	28	119 (88)	78 (57)
Stress Relieved 1 hr. @ 621°C (1150°F)	440 (64)	550 (80)	32	183 (135)	156 (115)
As-Welded with 98% Ar/2% O <sub>2</sub>	455 (66)	565 (82)	27	122 (90)	108 (80)
Stress Relieved 1 hr. @ 621°C (1150°F)	415 (60)	545 (79)	34	190 (140)	176 (130)

**WIRE COMPOSITION – As Required per AWS A5.18**

	%C	%Mn	%Si	%S	%P
<b>Requirements</b> - AWS ER70S-6	0.06-0.15	1.40-1.85	0.80-1.15	0.035 max	0.025 max
<b>Typical Results<sup>(3)</sup></b>	0.08-0.09	1.42-1.60	0.81-0.87	0.006-0.010	0.004-0.010
	%Cr	%Ni	%Mo	%V	%Cu (Total) <sup>(4)</sup>
<b>Requirements</b> - AWS ER70S-6	0.15 max	0.15 max	0.15 max	0.03 max	0.50 max
<b>Typical Results<sup>(3)</sup></b>	0.01-0.05	≤ 0.04	≤ 0.01	< 0.01	0.17-0.22

**TYPICAL OPERATING PROCEDURES**

Diameter, Polarity Shielding Gas	CTWD <sup>(5)</sup> mm (in)	Wire Feed Speed m/min (in/min)	Voltage (volts)	Approx. Current (amps)	Melt-Off Rate kg/hr (lb/hr)
<b>0.025 in (0.6 mm), DC+</b>					
Short Circuit Transfer 100% CO <sub>2</sub>	9-12 (3/8-1/2)	2.5 (100)	17	35	0.4 (0.9)
		6.4 (250)	19	80	0.9 (2.0)
<b>0.030 in (0.8 mm), DC+</b>					
Short Circuit Transfer 100% CO <sub>2</sub>	9-12 (3/8-1/2)	1.9 (75)	17	35	0.4 (0.9)
		3.8 (150)	18	70	0.8 (1.8)
		7.6 (300)	22	130	1.6 (3.6)
<b>0.035 in (0.9 mm), DC+</b>					
Short Circuit Transfer 100% CO <sub>2</sub> <sup>(6)</sup>	9-12 (3/8-1/2)	2.5 (100)	18	80	0.7 (1.6)
		3.8 (150)	19	120	1.1 (2.4)
		6.4 (250)	22	175	1.8 (4.0)
Spray Transfer 90% Ar/10% CO <sub>2</sub>	12-19 (1/2-3/4)	9.5 (375)	23	195	2.7 (6.0)
		12.7 (500)	29	230	3.6 (8.0)
		15.2 (600)	30	275	4.4 (9.6)
<b>0.045 in (1.1 mm), DC+</b>					
Short Circuit Transfer 100% CO <sub>2</sub> <sup>(6)</sup>	12-19 (1/2-3/4)	3.2 (125)	19	145	1.5 (3.4)
		3.8 (150)	20	165	1.8 (4.0)
		5.1 (200)	21	200	2.5 (5.4)
Spray Transfer 90% Ar/10% CO <sub>2</sub>	12-19 (1/2-3/4)	8.9 (350)	27	285	4.2 (9.2)
		12.1 (475)	30	335	5.7 (12.5)
		12.7 (500)	30	340	6.0 (13.2)
<b>0.052 in (1.3 mm), DC+</b>					
Spray Transfer 90% Ar/10% CO <sub>2</sub>	12-19 (1/2-3/4)	7.6 (300)	30	300	4.8 (10.7)
		8.1 (320)	30	320	5.2 (11.5)
		12.3 (485)	32	430	7.8 (17.1)
<b>1/16 in (1.6 mm), DC+</b>					
Spray Transfer 90% Ar/10% CO <sub>2</sub>	12-25 (1/2-1)	5.3 (210)	27	325	4.8 (10.7)
		6.0 (235)	28	350	5.4 (12.0)
		7.4 (290)	29	430	6.7 (14.8)

<sup>(1)</sup>Typical all weld metal. <sup>(2)</sup>Measured with 0.2% offset. <sup>(3)</sup>See test results disclaimer. <sup>(4)</sup>Copper due to any coating on the electrode plus the copper content of the filler metal itself, shall not exceed the stated 0.50% max. <sup>(5)</sup>CTWD (Contact Tip to Work Distance). Subtract 1/4 in (6.4 mm) to calculate Electrical Stickout. <sup>(6)</sup>Procedures in these areas are procedures for short circuiting mode using 100% CO<sub>2</sub>. When using 75% Argon, 25% CO<sub>2</sub>, for short circuit transfer, reduce voltage by 1 to 2 volts.

# SUPERARC® L-59®

Mild Steel, Copper Coated ■ AWS ER70S-6



## KEY FEATURES

- Engineered alloy system enhances silicon island management
- Minimal spatter
- Copper coating provides superior arc-starting characteristics for long contact tip life
- Fast travel speeds
- MicroGuard® Ultra provides superior feeding and arc stability

## WELDING POSITIONS

All

## SHIELDING GAS

100% CO<sub>2</sub>  
 75-95% Argon / Balance CO<sub>2</sub>  
 95-98% Argon / Balance O<sub>2</sub>  
 Flow Rate: 30 - 50 CFH

## CONFORMANCES

<b>AWS A5:</b>	ER70S-6
<b>ABS:</b>	3YSA H5
<b>CWB/CSA:</b>	B-G 49A 3 C1 S6
<b>DNV:</b>	III Y40MS H5
<b>Lloyd's Register:</b>	3YS H5
<b>BV:</b>	SA3YHHH
<b>ISO:</b>	G 42 4 M20 3Si1

## TYPICAL APPLICATIONS

- Robotic or hard automation
- Automotive
- Pipeline & Offshore
- Pressure vessels
- Heavy fabrication
- Alternative to metal-cored wire

## DIAMETERS / PACKAGING

Diameter in (mm)	33 lb (14.9 kg) Plastic Spool	44 lb (20 kg) Fiber Spool	44 lb (20 kg) Steel Spool	60 lb (27.2 kg) Fiber Spool	500 lb (227 kg) Accu-Pak® Box
0.035 (0.9)	ED034270	ED033033	ED032366		ED032894
0.040 (1.0)					ED032895
0.045 (1.1)	ED034271		ED032367		ED032896
0.052 (1.3)	ED034272	ED034430*	ED032368	ED032814	ED032897
1/16 (1.6)	ED034356	ED036220**	ED032968		
Diameter in (mm)	500 lb (227 kg) Infinity-Pak®	900 lb (408 kg) Accu-Pak® Box	1000 lb (454 kg) Infinity-Pak®	1000 lb (454 kg) Accu-Pak® Box	1000 lb (454 kg) Precise-Trak® Reel
0.035 (0.9)	ED034402	ED032861			
0.040 (1.0)					
0.045 (1.1)			ED033215	ED032863	ED032808
0.052 (1.3)				ED032864, ED034431*	ED032809
1/16 (1.6)				ED032865	

\*Buy America Product \*\*Tested Material

**MECHANICAL PROPERTIES<sup>(1)</sup> – As Required per AWS A5.18**

	Yield Strength <sup>(2)</sup> MPa (ksi)	Tensile Strength MPa (ksi)	Elongation %	Charpy V-Notch J (ft·lbf)	
				@ -29°C (-20°F)	@ -40°C (-40°F)
<b>Requirements - AWS ER70S-6</b> As-Welded with 100% CO <sub>2</sub>	400 (58) min	485 (70) min	22 min	27 (20) min	Not Specified
<b>Typical Results<sup>(3)</sup></b> As-Welded with 100% CO <sub>2</sub>	455 (66)	565 (82)	28	71 (52)	53 (39)
As-Welded with 75% Ar/25% CO <sub>2</sub>	485 (70)	595 (86)	25	56 (41)	53 (39)
As-Welded with 90% Ar/10% CO <sub>2</sub>	460 (67)	570 (83)	25	75 (55)	65 (48)

**WIRE COMPOSITION – As Required per AWS A5.18**

	%C	%Mn	%Si	%S	%P
<b>Requirements - AWS ER70S-6</b>	0.06-0.15	1.40-1.85	0.80-1.15	0.035 max	0.025 max
	%Cu <sup>(4)</sup>	%Ni	%Cr	%Mo	%V
<b>Requirements - AWS ER70S-6</b>	0.50 max	0.15 max	0.15 max	0.15 max	0.03 max

**TYPICAL OPERATING PROCEDURES**

Diameter, Polarity Shielding Gas	CTWD <sup>(5)</sup> mm (in)	Wire Feed Speed m/min (in/min)	Voltage (volts)	Approx. Current (amps)	Melt-Off Rate kg/hr (lb/hr)
<b>0.035 in (0.9 mm), DC+</b>					
Short Circuit Transfer 75% Ar/25% CO <sub>2</sub> <sup>(6)</sup>	12 (1/2)	2.5 (100)	17	80	0.7 (1.6)
		3.8 (150)	18	120	1.1 (2.4)
		6.4 (250)	20	175	1.8 (4.0)
Spray Transfer 90% Ar/10% CO <sub>2</sub>	19 (3/4)	9.5 (375)	23	195	2.7 (6.0)
		12.7 (500)	29	230	3.6 (8.0)
		15.2 (600)	30	275	4.4 (9.6)
<b>0.045 in (1.1 mm), DC+</b>					
Short Circuit Transfer 75% Ar/25% CO <sub>2</sub> <sup>(6)</sup>	12 (1/2)	3.2 (125)	18	145	1.5 (3.4)
		3.8 (150)	19	165	1.8 (4.0)
		5.1 (200)	20	200	2.4 (5.4)
Spray Transfer 90% Ar/10% CO <sub>2</sub>	19 (3/4)	8.9 (350)	27	285	4.2 (9.2)
		12.1 (475)	30	335	5.7 (12.5)
		12.7 (500)	30	340	6.0 (13.2)
<b>0.052 in (1.3 mm), DC+</b>					
Spray Transfer 90% Ar/10% CO <sub>2</sub>	19 (3/4)	7.6 (300)	30	300	4.8 (10.6)
		8.1 (320)	30	320	5.2 (11.5)
		12.3 (485)	32	430	7.8 (17.1)
<b>1/16 in (1.6 mm), DC+</b>					
Spray Transfer 90% Ar/10% CO <sub>2</sub>	19 (3/4)	5.3 (210)	25	325	4.8 (10.7)
		6.0 (235)	27	350	5.4 (12.0)
		7.4 (290)	28	430	6.7 (14.8)

<sup>(1)</sup>Typical all weld metal. <sup>(2)</sup>Measured with 0.2% offset. <sup>(3)</sup>See test results disclaimer <sup>(4)</sup>Copper due to any coating on the electrode plus the copper content of the filler metal itself, shall not exceed the stated 0.50% max. <sup>(5)</sup>CTWD (Contact Tip to Work Distance). Subtract 1/4 in (6.4 mm) to calculate Electrical Stickout. <sup>(6)</sup>Procedures in these areas are procedures for short circuiting mode using 75% Argon, 25% CO<sub>2</sub>. NOTE: For 100% CO<sub>2</sub> procedures, add 1 to 2 volts for short circuit transfer and 2 to 3 volts for globular transfer.

# SUPERARC® G4Si1

Mild Steel, Copper Coated ▪ AWS ER70S-6

## KEY FEATURES

- Higher strength than typical ER70S-6 products to enable conformance to both AWS and EN ISO standards
- Excellent toe-wetting provides optimal bead appearance
- Copper coating provides superior arc-starting characteristics for long contact tip life
- Supports short-circuiting, globular, axial spray and pulsed spray transfer
- Microguard® Ultra provides superior feeding and arc stability

## CONFORMANCES

**AWS A5:** ER70S-6  
**ISO:** G 46 3 C1 4Si1 G 50 5 M20 4Si1

## TYPICAL APPLICATIONS

- Automotive Repair
- Automotive Components
- Robotic or Hard Automation

## WELDING POSITIONS

All

## SHIELDING GAS

100% CO<sub>2</sub>  
 85-90% Argon / Balance CO<sub>2</sub>  
 Flow Rate: 30-50 CFH

## DIAMETERS / PACKAGING

Diameter in (mm)	500 lb (227 kg) Accu-Pak® Box	1000 lb (454 kg) Accu-Pak® Box
0.045 (1.1)	ED037131	ED037156

## MECHANICAL PROPERTIES<sup>(1)</sup>

Charpy V-Notch J (ft-lbf)	Yield Strength <sup>(2)</sup> ksi (MPa)	Tensile Strength ksi (MPa)	Elongation %	Charpy V-Notch J (ft-lbf)		
				@ -29°C (-20°F)	@ -30°C (-22°F)	@ -50°C (-58°F)
<b>Requirements – AWS A5.18</b> ER70S-6, As-Welded with 100% CO <sub>2</sub>	400 (58) min	485 (70) min	22 min	27 (20) min	-	-
<b>Typical Results<sup>(3)</sup> – AWS A5.18</b> As-Welded w/100% CO <sub>2</sub>	470 (68)	590 (85)	25	56 (41)	-	-
<b>Requirements – EN ISO 14341-A</b> G 46 3 C1 G4Si1, As-Welded with 100% CO <sub>2</sub> G 50 5 M20 G4Si1, As-Welded with 85%Argon/Balance CO <sub>2</sub>	460 (67) min 500 (73) min	530-680 (77-99) 560-720 (81-104)	20 min. 18 min.	- -	47 (35) min. -	- 47 (35) min
<b>Typical Results<sup>(3)</sup> – EN ISO 14341-A</b> As-Welded with 100% CO <sub>2</sub> As-Welded with 85% Argon/Balance CO <sub>2</sub>	490 (71) 520 (75)	600 (87) 620 (90)	24 23	- -	90 (66) -	- 81 (60)

**WIRE COMPOSITION**

	<b>%C</b>	<b>%Mn</b>	<b>%Si</b>	<b>%S</b>	<b>%P</b>
<b>Requirements - AWS A5.18, ER70S-6</b>	0.06-0.15	1.40-1.85	0.80-1.15	0.035 max.	0.025 max.
<b>Requirements - EN ISO 14341-A, G4Si1</b>	0.06-0.14	1.60-1.90	0.80-1.20	0.025 max.	0.025 max.
<b>Typical Results<sup>(3)</sup></b>	0.09	1.67	0.87	0.006-0.010	0.004-0.010
	<b>%CR</b>	<b>%Ni</b>	<b>%Mo</b>	<b>%V</b>	<b>%Cu (Total)<sup>(4)</sup></b>
<b>Requirements - AWS A5.18, ER70S-6</b>	0.15 max.	0.15 max.	0.15 max.	0.03 max.	0.50 max.
<b>Requirements - EN ISO 14341-A, G4Si1</b>	0.15 max.	0.15 max.	0.15 max.	0.03 max.	0.35 max.
<b>Typical Results<sup>(3)</sup></b>	0.02	0.02	<0.01	<0.01	0.20

**TYPICAL OPERATING PROCEDURES**

<b>Diameter, Polarity, Shielding Gas</b>	<b>CTWD<sup>(5)</sup> mm (in)</b>	<b>Wire Feed Speed m/min (in/min)</b>	<b>Voltage (Volts)</b>	<b>Approx. Current (amps)</b>	<b>Melt-Off Rate kg/hr (lb/hr)</b>
<b>0.045 in (1.1 mm), DC+</b>					
Short Circuit Transfer <sup>(6)</sup> 100% CO <sub>2</sub>	12-19 (1/2-3/4)	3.2 (125)	19	145	1.5 (3.4)
		3.8 (150)	20	165	1.8 (4.0)
		5.1 (200)	21	200	2.5 (5.4)
Spray Transfer 85% Argon/15% CO <sub>2</sub>	12-19 (1/2-3/4)	8.9 (350)	27	285	4.2 (9.2)
		12.1 (475)	30	335	5.7 (12.5)
		12.7 (500)	30	340	6.0 (13.2)

<sup>(1)</sup> Typical all weld metal. <sup>(2)</sup> Measured with 0.2% offset. <sup>(3)</sup> See test results disclaimer. <sup>(4)</sup> Copper due to any coating on the electrode plus the copper content of the filler metal itself, shall not exceed the stated 0.50% max. <sup>(5)</sup> CTWD (Contact Tip to Work Distance). Subtract 1/4 in (6.4 mm) to calculate Electrical Stickout. <sup>(6)</sup> Procedures in these areas are procedures for short circuiting mode using 100% CO<sub>2</sub>. When using 75% Argon, 25% CO<sub>2</sub> for short circuit transfer, reduce voltage by 1 to 2 volts



# MUREMATIC® S3

Mild Steel, Copper Coated ▪ AWS ER70S-3

## KEY FEATURES

- Copper coating provides superior arc-starting characteristics for long contact tip life
- Manganese and silicon content of an S-3 wire can tolerate low levels of mill scale on the base material
- MicroGuard® surface treatment provides superior feeding
- Manufactured in the USA

## SHIELDING GAS

100% CO<sub>2</sub>  
 75-95% Ar/Balance CO<sub>2</sub>  
 95-98% Ar/Balance CO<sub>2</sub>  
 Flow Rate: 30 - 50 CFH

## CONFORMANCES

AWS A5 18: ER70S-3  
 ASME SFA-A5.18: ER70S-3

## TYPICAL APPLICATIONS

- Industrial
- Farming
- Construction
- Mining equipment
- For welding on base material that is clean or has light mill scale
- General fabrication

## WELDING POSITIONS

All

## DIAMETERS / PACKAGING

Diameter in (mm)	44 lb (20 kg) Steel Spool	44 lb (20 kg) Fiber Spool	60 lb (27 kg) Fiber Spool	500 lb (227 kg) Accu-Trak® Drum	1000 lb (453 kg) Speed Feed® Drum	1000 lb (453 kg) Accu-Trak® Drum
0.035 (0.9)	EDM23347543	EDM23346593	EDM23346713	EDM23346783	EDM23346513	EDM23346573
0.045 (1.1)	EDM23347545	EDM23346595	EDM23346715	EDM23346785		EDM23346575
0.052 (1.3)						EDM23346576

## MECHANICAL PROPERTIES<sup>(1)</sup> – As Required per AWS A5.18

	Yield Strength <sup>(2)</sup> MPa (ksi)	Tensile Strength MPa (ksi)	Elongation %	Charpy V-Notch J (ft-lbf) @ 0°F (-18°C)
Requirements - AWS ER70S-3	58,000 (400) min	70,000 (483) min	22 min	27 (20) min
Typical Results <sup>(3)</sup>	64,900 (447)	81,000 (559)	24	67 (91)

## WIRE COMPOSITION<sup>(1)</sup> – As Required per AWS A5.18

	%C	%Mn	%Si	%P	%S	%Ni	%Cr	%Mo	%V	Cu (total)
Requirements - AWS ER70S-3	0.06-0.15	0.90-1.40	0.45-0.75	0.025 max	0.035 max	0.15 max	0.15 max	0.15 max	0.03 max	0.50 max
Typical Results <sup>(3)</sup> - As-Welded	0.10	1.23	0.56	0.014	0.008	0.04	0.03	0.01	-	0.17

## TYPICAL OPERATING PROCEDURES

Diameter, Polarity Shielding Gas	Wire Feed Speed in/min (mm/min)	Voltage (volts)	Approx. Current (amps)	Melt-Off Rate lb/hr (kg/hr)
<b>0.035 in (0.9 mm), DC+</b>				
Short Circuit Transfer - 100% CO <sub>2</sub>	100-250 (2.5-6.4)	18-22	80-175	1.6-4.0 (0.7-1.8)
Spray Transfer - 90% Ar/10% CO <sub>2</sub>	375-600 (9.5-15.2)	23-30	195-275	6.0-9.6 (2.7-4.4)
<b>0.045 in (1.1 mm), DC+</b>				
Short Circuit Transfer - 100% CO <sub>2</sub>	125-200 (3.2-5.0)	19-21	145-200	3.4-5.4 (1.5-2.5)
Spray Transfer - 90% Ar/10% CO <sub>2</sub>	350-500 (8.9-12.7)	27-30	285-340	9.2-13.2 (4.2-6.0)
<b>0.052 in (1.3 mm), DC+</b>				
Spray Transfer - 90% Ar/10% CO <sub>2</sub>	300-485 (7.6-12.3)	30-32	300-430	10.6-17.1 (4.8-7.8)
<b>1/16 in (1.6 mm), DC+</b>				
Spray Transfer - 90% Ar/10% CO <sub>2</sub>	210-290 (5.3-7.4)	25-28	325-430	10.7-14.8 (4.8-6.7)

<sup>(1)</sup>Typical all weld metal. <sup>(2)</sup>Measured with 0.2% offset. <sup>(3)</sup>See test results disclaimer

# MUREMATIC® S4+

Mild Steel, Copper Coated Wire ■ AWS ER70S-4

## KEY FEATURES

- Highly resistant to copper flaking which can clog liners and contact tips
- Copper coating provides superior arc-starting characteristics, for long contact tip life
- MicroGuard® surface treatment provides superior feeding
- Manufactured in the USA

## WELDING POSITIONS

All

## SHIELDING GAS

100% CO<sub>2</sub>  
 75-95% Ar/Balance CO<sub>2</sub>  
 95-98% Ar/Balance CO<sub>2</sub>  
 Flow Rate: 30 - 50 CFH

## DIAMETERS / PACKAGING

Diameter in (mm)	30 lb (13 kg) Spool	44 lb (20 kg) Steel Spool	44 lb (20 kg) Fiber Spool	60 lb (27 kg) Fiber Spool	500 lb (227 kg) Accu-Trak® Drum	1000 lb (453 kg) Accu-Trak® Drum
0.035 (0.9)	EDM23346353	EDM23347343	EDM23346393	EDM23346313	EDM23346383	EDM23346173
0.045 (1.1)	EDM23346355		EDM23346395	EDM23346315	EDM23346385	
0.052 (1.3)		EDM23346396				

## CONFORMANCES

AWS A5 18: ER70S-4  
 ASME SFA-A5.18: ER70S-4

## TYPICAL APPLICATIONS

- Applications which require greater cleaning action through increased levels of silicon and manganese compared to the levels provided by a typical ER70S-3 wire
- Industrial
  - For welding on base material that is clean or has light mill scale
- Farming
- Construction
  - General fabrication
- Mining equipment

## MECHANICAL PROPERTIES<sup>(1)</sup> – As Required per AWS A5.18

	Yield Strength <sup>(2)</sup> MPa (ksi)	Tensile Strength MPa (ksi)	Elongation %	Charpy V-Notch J (ft·lbf) @ -20°F (-29°C)
Requirements - AWS ER70S-4	58,000 (400) min	70,000 (483) min	22 min	Not Specified
Typical Results <sup>(3)</sup>	64,000 (441)	79,000 (555)	28	58 (79)

## WIRE COMPOSITION – As Required per AWS A5.18

	%C	%Mn	%Si	%P	%S	%Ni	%Cr	%Mo	%V	Cu (total)
Requirements - AWS ER70S-4	0.06-0.15	1.00-1.50	0.65-0.85	0.025 max	0.035 max	0.15 max	0.15 max	0.15 max	0.03 max	0.50 max
Typical Results <sup>(3)</sup> - As-Welded	0.09	1.28	0.73	0.018	0.010	0.06	0.05	0.02	-	0.26

## TYPICAL OPERATING PROCEDURES

Diameter, Polarity Shielding Gas	Wire Feed Speed in/min (mm/min)	Voltage (volts)	Approx. Current (amps)	Melt-Off Rate lb/hr (kg/hr)
<b>0.035 in (0.9 mm), DC+</b>				
Short Circuit Transfer - 100% CO <sub>2</sub>	100-250 (2.5-6.4)	18-22	80-175	1.6-4.0 (0.7-1.8)
Spray Transfer - 90% Ar/10% CO <sub>2</sub>	375-600 (9.5-15.2)	23-30	195-275	6.0-9.6 (2.7-4.4)
<b>0.045 in (1.1 mm), DC+</b>				
Short Circuit Transfer - 100% CO <sub>2</sub>	125-200 (3.2-5.0)	19-21	145-200	3.4-5.4 (1.5-2.5)
Spray Transfer - 90% Ar/10% CO <sub>2</sub>	350-500 (8.9-12.7)	27-30	285-340	9.2-13.2 (4.2-6.0)
<b>0.052 in (1.3 mm), DC+</b>				
Spray Transfer - 90% Ar/10% CO <sub>2</sub>	300-485 (7.6-12.3)	30-32	300-430	10.6-17.1 (4.8-7.8)
<b>1/16 in (1.6 mm), DC+</b>				
Spray Transfer - 90% Ar/10% CO <sub>2</sub>	210-290 (5.3-7.4)	25-28	325-430	10.7-14.8 (4.8-6.7)

<sup>(1)</sup>Typical all weld metal. <sup>(2)</sup>Measured with 0.2% offset. <sup>(3)</sup>See test results disclaimer

# MUREMATIC® S6

Mild Steel, Copper Coated Wire ■ AWS ER70S-6

## KEY FEATURES

- Excellent spatter control and bead profile
- MicroGuard® surface treatment provides superior feeding
- Copper coating provides superior arc-starting characteristics for long contact tip life
- Manufactured in the USA

## WELDING POSITIONS

All

## SHIELDING GAS

100% CO<sub>2</sub>  
75-95% Ar/Balance CO<sub>2</sub>  
95-98% Ar/Balance CO<sub>2</sub>  
Flow Rate: 30 - 50 CFH

## DIAMETERS / PACKAGING

Diameter in (mm)	30 lb (13 kg) Spool	44 lb (20 kg) Steel Spool	44 lb (20 kg) Fiber Spool	60 lb (27 kg) Fiber Spool	60 lb (27 kg) Coil	500 lb (227 kg) Accu-Trak® Drum	1000 lb (453 kg) Accu-Trak® Drum
0.030 (0.8)	EDM23346852					EDM23346883	EDM23346673
0.035 (0.9)	EDM23346853	EDM23347843	EDM23346893			EDM23346885	EDM23346675
0.045 (1.1)	EDM23346855	EDM23347845	EDM23346895	EDM23347815	EDM23346875	EDM23346886	EDM23346676

## CONFORMANCES

AWS A5 18: ER70S-6  
ASME SFA-A5.18: ER70S-6

## TYPICAL APPLICATIONS

- Applications which require greater cleaning action through increased levels of silicon and manganese compared to the levels provided by a typical ER70S-3 or ER70S-4 wire
- Industrial
- Farming
- Construction
- Mining equipment
- Auto repair
- For welding on metals with a medium-to-high presence of mill scale

## MECHANICAL PROPERTIES – As Required per AWS A5.18

	Yield Strength <sup>(2)</sup> MPa (ksi)	Tensile Strength MPa (ksi)	Elongation %	Charpy V-Notch J (ft·lbf) @ -20°F (-29°C)
Requirements - AWS ER70S-6	58,000 (400) min	70,000 (483) min	22 min	20 (27) min
Typical Results <sup>(3)</sup>	67,000 (462)	82,000 (565)	27	52 (71)

## WIRE COMPOSITION<sup>(1)</sup> – As Required per AWS A5.18

	%C	%Mn	%Si	%P	%S	%Ni	%Cr	%Mo	%V	Cu (total)
Requirements - AWS ER70S-6	0.06-0.15	1.40-1.85	0.80-1.15	0.025 max	0.035 max	0.15 max	0.15 max	0.15 max	0.03 max	0.50 max
Typical Results <sup>(3)</sup> - As-Welded	0.07	1.44	0.73	0.011	0.007	0.02	0.02	0.01	-	0.21

## TYPICAL OPERATING PROCEDURES

Diameter, Polarity Shielding Gas	Wire Feed Speed in/min (mm/min)	Voltage (volts)	Approx. Current (amps)	Melt-Off Rate lb/hr (kg/hr)
<b>0.035 in (0.9 mm), DC+</b>				
Short Circuit Transfer - 100% CO <sub>2</sub>	100-250 (2.5-6.4)	18-22	80-175	1.6-4.0 (0.7-1.8)
Spray Transfer - 90% Ar/10% CO <sub>2</sub>	375-600 (9.5-15.2)	23-30	195-275	6.0-9.6 (2.7-4.4)
<b>0.045 in (1.1 mm), DC+</b>				
Short Circuit Transfer - 100% CO <sub>2</sub>	125-200 (3.2-5.0)	19-21	145-200	3.4-5.4 (1.5-2.5)
Spray Transfer - 90% Ar/10% CO <sub>2</sub>	350-500 (8.9-12.7)	27-30	285-340	9.2-13.2 (4.2-6.0)
<b>0.052 in (1.3 mm), DC+</b>				
Spray Transfer - 90% Ar/10% CO <sub>2</sub>	300-485 (7.6-12.3)	30-32	300-430	10.6-17.1 (4.8-7.8)
<b>1/16 in (1.6 mm), DC+</b>				
Spray Transfer - 90% Ar/10% CO <sub>2</sub>	210-290 (5.3-7.4)	25-28	325-430	10.7-14.8 (4.8-6.7)

<sup>(1)</sup>Typical all weld metal. <sup>(2)</sup>Measured with 0.2% offset. <sup>(3)</sup>See test results disclaimer

# 1CRMO

Low Alloy Steel ■ AWS ER80S-G

## KEY FEATURES

- Modified ER80S-B2 wire optimized for GMAW
- Developed for 1 1/4 Cr-1/2Mo steels
- Designed for prolonged elevated service temperature up to 550°C
- Superior feedability

## WELDING POSITIONS

All

## SHIELDING GAS

75-90% Ar/Balance CO  
Flow Rate: 30-50 CFH

## CONFORMANCES

**AWS 5.28:** ER80S-G  
**BS EN ISO 21952-A** CrMo1Si

## TYPICAL APPLICATIONS

- Steam Generating Power Plant
- Process Piping
- Coal Liquefaction Plant
- NH<sub>3</sub> Pressure Vessels
- Offshore

## DIAMETERS / PACKAGING

Diameter mm (in)	15 kg (33.1 lb) Spool
1.2 (0.045)	M1CRMO-12

## MECHANICAL PROPERTIES<sup>(1)</sup> – As Required per AWS A5.28

	Yield Strength <sup>(2)</sup> MPa (ksi)	Tensile Strength MPa (ksi)	Elongation %	Charpy V-Notch J (ft-lbf) @-10°C (14°F)	Hardness HV
<b>Requirements</b> AWS ER80S-G	470 (68) min	550 (80) min	19 min	Not Specified	-
<b>Typical Results<sup>(4)</sup></b>	480 (690)	590 (85)	26	>115	195

## DEPOSIT COMPOSITION<sup>(1)</sup> – As Required per AWS A5.28

	%C	%Mn	%Si	%S	%P
<b>Requirements</b> AWS ER80S-G	0.08-0.14	0.8-1.2	0.5-0.8	0.02 max	0.02 max
<b>Typical Results<sup>(3)</sup></b>	0.1	1	0.6	0.01	0.015
	%Cr	%Ni	%Mo	%Cu	
<b>Requirements</b> AWS ER80S-G	0.9-1.3	-	0.45-.065	0.4 max	
<b>Typical Results<sup>(3)</sup></b>	1.2	<0.1	0.5	0.1	

## TYPICAL OPERATING PROCEDURES

Diameter mm (in)	Polarity	Amperage	Voltage
1.2 (0.045)	DC+	150-280A	18-26V

<sup>(1)</sup> Typical all weld metal <sup>(2)</sup> Measured with 0.2% offset <sup>(3)</sup> See test results disclaimer <sup>(4)</sup> PWHT 690°C/4h (AWS= 1h)

# 2CRMO

Low Alloy Steel ■ AWS ER90S-G

## KEY FEATURES

- Designed for high strength and improved hardness to resist metal-to-metal wear
- Developed to provide corrosion resistance to Sulphur bearing crude oil
- Superior feedability

## WELDING POSITIONS

All

## SHIELDING GAS

95% Argon / 5% CO

## CONFORMANCES

**AWS 5.28:** ER90S-G  
**BS EN ISO 21952-A** CrMo2Si

## TYPICAL APPLICATIONS

- Steam Generating Power Plant
- Piping
- Coal Liquefaction Plant
- NH<sub>3</sub> Pressure Vessels

## DIAMETERS / PACKAGING

Diameter mm (in)	15 kg (33.1 lb) Spool
0.8 (0.035)	M2CRMO-08
1.2 (0.045)	M2CRMO-12

## MECHANICAL PROPERTIES<sup>(1)</sup> – As Required per AWS A5.28

	Yield Strength <sup>(2)</sup> MPa (ksi)	Tensile Strength MPa (ksi)	Elongation %	Charpy V-Notch J (ft-lbf) @-10 °C (14 °F)	Hardness HV
<b>Requirements</b> AWS ER90S-G	540 (78) min	620 (90) min	17 min	-	-
<b>Typical Results<sup>(3)</sup></b>	540 (78)	655 (95)	23	>95	220

## DEPOSIT COMPOSITION<sup>(1)</sup> – As Required per AWS A5.28

	%C	%Mn	%Si	%S	%P
<b>Requirements</b> AWS ER90S-G	0.06-0.12	0.80-1.20	0.50-0.80	0.02 max	0.02 max
<b>Typical Results<sup>(3)</sup></b>	0.1	1	0.6	0.01	0.015
	%Cr	%Ni	%Mo	%Cu	
<b>Requirements</b> AWS ER90S-G	2.30-2.70	-	0.90-1.10	0.4 max	
<b>Typical Results<sup>(3)</sup></b>	2.4	<0.1	1	0.15	

## TYPICAL OPERATING PROCEDURES

Diameter mm (in)	Polarity	Amperage	Voltage
1.2 (0.045)	DC+	280A	26V

<sup>(1)</sup> Typical all weld metal <sup>(2)</sup> Measured with 0.2% offset <sup>(3)</sup> See test results disclaimer



# ER90S-B3

Low Alloy Steel ■ AWS ER90S-B3

## KEY FEATURES

- Developed for 2 ¼ Cr-1Mo creep resisting steels
- Design for high strength and improved hardness to resist metal-to-metal wear
- Superior feedability

## WELDING POSITIONS

All

## SHIELDING GAS

95% Argon / 5% CO

## CONFORMANCES

AWS 5.28 ER90S-B3  
BS EN ISO 21952-B 2C1M

## TYPICAL APPLICATIONS

- Steam Generating Power Plant
- Piping
- Coal Liquefaction Plant
- NH<sub>3</sub> Pressure Vessels

## DIAMETERS / PACKAGING

Diameter mm (in)	15 kg (33.1 lb) Spool
1.2 (.045)	MER90SB3-12

## MECHANICAL PROPERTIES<sup>(1)</sup> – As Required per AWS A5.28

	Yield Strength <sup>(2)</sup> MPa (ksi)	Tensile Strength MPa (ksi)	Elongation %	Charpy V-Notch J (ft-lbf) @-10°C (14°F)	Hardness HV
<b>Requirements</b> AWS ER90S-B3	540 (78) min	620 (90) min	17 min	-	-
<b>Typical Results<sup>(3)</sup></b> As-Welded	540 (78)	655 (95)	23	>95	220

## WIRE COMPOSITION<sup>(1)</sup> – As Required per AWS A5.28

	%C	%Mn	%Si	%S	%P
<b>Requirements</b> AWS ER90S-B3	0.07-0.12	0.40-0.70	0.40-0.70	0.02 max	0.02 max
<b>Typical Results<sup>(3)</sup></b>	0.1	0.5	0.5	0.01	0.015
	%Cr	%Ni	%Mo	%Cu	
<b>Requirements</b> AWS ER90S-B3	2.3-2.7	0.20 max	0.9-1.2	0.35 max	
<b>Typical Results<sup>(3)</sup></b>	2.4	<0.1	1	0.1	

## TYPICAL OPERATING PROCEDURES

Diameter mm (in)	Polarity	Amperage	Voltage
1.2 (0.045)	DC+	280A	26V

<sup>(1)</sup> Typical all weld metal <sup>(2)</sup> Measured with 0.2% offset. <sup>(3)</sup> See test results disclaimer

# TECHALLOY® 4130

Low Alloy Steel

## KEY FEATURES

- High strength, low alloy
- Preheat and inter-pass temperature of 400°F (204.4°C) is required

## WELDING POSITIONS

All

## TYPICAL APPLICATIONS

- Joining steels of similar chemical composition
- Overlays where moderate hardness is required

## SHIELDING GAS

75% Ar/ 25%CO<sub>2</sub>  
98% Ar/ 2% O<sub>2</sub>

## DIAMETERS / PACKAGING

Diameter in (mm)	MIG 33 lb (15 kg) Steel Spool
0.035 (0.9)	MG4130035659
0.045 (1.1)	MG4130045659
1/16 (1.6)	MG4130062659

## MECHANICAL PROPERTIES<sup>(4)</sup>

	Yield Strength <sup>(2)</sup> MPa (ksi)	Tensile Strength MPa (ksi)	Elongation %
Typical Results <sup>(3)</sup>	900 (130)	1,000 (145)	11

## WIRE COMPOSITION<sup>(1)</sup>

	%C	%Mn	%Si	%Fe	%Cr	%Mo	%Ni	%V
Typical Results <sup>(3)</sup>	0.31	0.52	0.28	Balance	0.93	0.20	-	-

## TYPICAL OPERATING PROCEDURES

Process	Diameter in (mm)	Voltage (volts)	Amperage	Gas
MIG – Spray Transfer	0.035 (0.9)	26.5-31	180-250	98% Ar / 2% O <sub>2</sub>
	0.045 (1.1)	28-32	300-380	
	1/16 (1.6)	28-32	350-400	
MIG – Short Circuit Transfer	0.035 (0.9)	22-26	150-175	75% Ar / 2% CO <sub>2</sub>
	0.045 (1.1)	23-26	175-215	

<sup>(1)</sup>Typical deposit composition. <sup>(2)</sup>Measured with 0.2% offset. <sup>(3)</sup>See test results disclaimer. <sup>(4)</sup>Quenched from 1,550 F (843 C) in oil and tempered at 1,050 F (565 C). Safety Data Sheets (SDS) are available on our website at [www.lincolnelectric.com](http://www.lincolnelectric.com)



# SUPERARC® LA-75™

Low Alloy, Copper Coated ■ AWS ER80S-Ni1 & ENi1K



## KEY FEATURES

- Capable of producing weld deposits with 550 MPa (80 ksi) tensile strength
- High toughness at low temperatures with a nominal 1% Ni or less
- MicroGuard® Ultra provides superior feeding and arc stability
- Supports short-circuiting, globular, axial spray and pulsed spray transfer
- Copper coating provides superior arc-starting characteristics for long contact tip life

## CONFORMANCES

<b>AWS A5:</b>	ER80S-Ni1
<b>CWB/CSA:</b>	ER80S-Ni1
<b>ISO:</b>	G 55A 4 M13 SN2 SUN21

## TYPICAL APPLICATIONS

- ASTM A588 weathering steel requiring good atmospheric corrosion resistance
- NACE applications

## WELDING POSITIONS

All

## SHIELDING GAS

90-95% Argon / Balance CO<sub>2</sub>  
 95-98% Argon / Balance O<sub>2</sub>  
 Flow Rate: 30 - 50 CFH

## DIAMETERS / PACKAGING

Diameter in (mm)	33 lb (15 kg) Steel Spool	44 lb (20 kg) Steel Spool
0.035 (0.9)	ED031415, ED033949**	
0.045 (1.1)	ED031416, ED034432*	
0.052 (1.3)		ED036509

\*Buy America Product. \*\*Q2 Tested Product.

## MECHANICAL PROPERTIES<sup>(1)</sup> – As Required per AWS A5.28

	Yield Strength <sup>(2)</sup> MPa (ksi)	Tensile Strength MPa (ksi)	Elongation %	Charpy V-Notch J (ft•lbf)		
				@ -29°C (-20°F)	@ -45°C (-50°F)	@ -62°C (-80°F)
<b>Requirements</b> – AWS ER80S-Ni1 As-Welded with 98% Ar/2% O <sub>2</sub>	470 (68) min	550 (80) min	24 min	Not Specified	27 (20) min	Not Specified
<b>Typical Results</b> <sup>(3)</sup>						
As-Welded with 90% Ar/10% CO <sub>2</sub>	475 (69)	580 (84)	28	119 (88)	82 (60)	35 (26)
Stress Relieved 1 hr. @ 621°C (1150° F)	450 (65)	565 (82)	32	- -	127 (93)	112 (82)
As-Welded with 98% Ar/2% O <sub>2</sub>	490 (71)	580 (84)	30	- -	172 (127)	- -
Stress Relieved 1 hr. @ 621°C (1150° F)	420 (61)	540 (78)	31	- -	230 (170)	165 (122)

<sup>(1)</sup>Typical all weld metal. <sup>(2)</sup>Measured with 0.2% offset. <sup>(3)</sup>See test results disclaimer.

**WIRE COMPOSITION – As Required per AWS A5.28**

	%C	%Mn	%Si	%Ni	%Cr
<b>Requirements</b> - AWS ER80S-Ni1	0.12 max	1.25 max	0.40-0.80	0.80-1.10	0.15 max
<b>Typical Results</b> <sup>(3)</sup>	0.07-0.08	0.94-1.04	0.54-0.58	0.88-0.98	≤ 0.04
	%Mo	%S	%P	%V	%Cu (Total) <sup>(4)</sup>
<b>Requirements</b> - AWS ER80S-Ni1	0.35 max	0.025 max	0.025 max	0.05 max	0.35 max
<b>Typical Results</b> <sup>(3)</sup>	≤ 0.02	0.007 - 0.010	0.005 - 0.010	< 0.01	0.16 - 0.21

**TYPICAL OPERATING PROCEDURES**

Diameter, Polarity Shielding Gas	CTWD <sup>(5)</sup> mm (in)	Wire Feed Speed m/min (in/min)	Voltage (volts)	Approx. Current (amps)	Melt-Off Rate kg/hr (lb/hr)
<b>0.035 in (0.9 mm), DC+</b>					
Short Circuit Transfer 90% Ar/ 10% CO <sub>2</sub>	9-12 (3/8-1/2)	2.5 (100)	17	80	0.7 (1.6)
		3.8 (150)	18	120	1.1 (2.4)
		6.4 (250)	22	175	1.8 (4.0)
Spray Transfer 90% Ar/10% CO <sub>2</sub>	12-19 (1/2-3/4)	9.5 (375)	23	195	2.7 (6.0)
		12.7 (500)	29	230	3.6 (8.0)
		15.2 (600)	30	275	4.4 (9.6)
<b>0.045 in (1.1 mm), DC+</b>					
Short Circuit Transfer 90% Ar/ 10% CO <sub>2</sub>	12-19 (1/2-3/4)	3.2 (125)	19	145	1.5 (3.4)
		3.8 (150)	20	165	1.8 (4.0)
		5.1 (200)	21	200	2.4 (5.4)
Spray Transfer 90% Ar/10% CO <sub>2</sub>	12-19 (1/2-3/4)	8.9 (350)	27	285	4.2 (9.2)
		12.1 (475)	30	335	5.7 (12.5)
		12.7 (500)	30	340	6.0 (13.2)

<sup>(1)</sup>Typical all weld metal. <sup>(2)</sup>Measured with 0.2% offset. <sup>(3)</sup>See test results disclaimer <sup>(4)</sup>Copper due to any coating on the electrode plus the copper content of the filler metal itself, shall not exceed the stated 0.50% max. <sup>(5)</sup>CTWD (Contact Tip to Work Distance). Subtract 1/4 in (6.4 mm) to calculate Electrical Stickout. NOTE: For 100% CO<sub>2</sub> procedures, add 1 to 2 volts for short circuit transfer and 2 to 3 volts for globular transfer.

# SUPERARC® LA-90™

Low Alloy, Copper Coated ■ AWS ER80S-D2, ER90S-D2 & EA3K

## KEY FEATURES

- Capable of producing weld deposits with 550 - 620 MPa (80 - 90 ksi) tensile strength
- Contains 0.50% molybdenum for strength after stress-relief
- MicroGuard® Ultra provides superior feeding and arc stability
- Supports short-circuiting, globular, axial spray and pulsed spray transfer
- Copper coating provides superior arc-starting characteristics for long contact tip life

## WELDING POSITIONS

All

## SHIELDING GAS

100% CO<sub>2</sub>  
95-98% Argon / Balance O<sub>2</sub>  
Flow Rate: 30 - 50 CFH

## CONFORMANCES

**AWS A5:** ER80S-D2, ER90S-D2  
**CWB/CSA:** ER80S-D2, ER90S-D2  
**ISO:** G59A 3 C1 4M31, G62A 3 M13 4M31

## TYPICAL APPLICATIONS

- Requirements for strength after stress relieving
- ASTM A182, A217, A234 and A335 high temperature service pipe, fittings, flanges and valves
- ASTM A336 pressure vessel forgings

## DIAMETERS / PACKAGING

Diameter in (mm)	33 lb (15 kg) Steel Spool	44 lb (20 kg) Steel Spool	44 lb (20 kg) Fiber Spool	
0.035 (0.9)	ED031413	EDS30775	ED029546	
0.045 (1.1)	ED031414	EDS30776		
0.052 (1.3)		EDS30777		
1/16 (1.6)				
Diameter in (mm)	60 lb (27.2 kg) Coil	60 lb (27.2 kg) Fiber Spool	500 lb (227 kg) Accu-Trak® Drum	
0.035 (0.9)			EDS01372	
0.045 (1.1)		EDS01380	ED001378	
0.052 (1.3)			ED026627	
1/16 (1.6)	ED013999			
Diameter in (mm)	500 lb (227 kg) Accu-Pak® Box	1000 lb (454 kg) Accu-Trak® Drum	1000 lb (454 kg) Accu-Pak® Box	1000 lb (454 kg) Infinity-Pak®
0.035 (0.9)		EDS29590		
0.045 (1.1)	ED032919	ED029591	ED034436	
0.052 (1.3)	ED032920	EDS29592		ED034955
1/16 (1.6)				

**MECHANICAL PROPERTIES<sup>(1)</sup> – As Required per AWS A5.28**

	Yield Strength <sup>(2)</sup> MPa (ksi)	Tensile Strength MPa (ksi)	Elongation %	Charpy V-Notch J (ft·lbf)	
				@ -29°C (-20°F)	@ -40°C (-40°F)
<b>Requirements - AWS ER80S-D2</b> As-Welded with 100% CO <sub>2</sub>	470 (68) min	550 (80) min	17 min	27 (20) min	Not Specified
AWS ER90S-D2 As-Welded with 95-99% Ar/Balance O <sub>2</sub>	540 (78) min	620 (90) min	17 min	27 (20) min	Not Specified
<b>Typical Results<sup>(3)</sup></b>					
As-Welded with 100% CO <sub>2</sub>	560 (81)	655 (95)	23	36 (26)	- -
As-Welded with 95% Ar/5% O <sub>2</sub>	650 (94)	730 (106)	25	125 (92)	- -
As-Welded with 75% Ar/25% CO <sub>2</sub>	620 (90)	705 (102)	26	124 (91)	122 (90)

**WIRE COMPOSITION – As Required per AWS A5.28**

	%C	%Mn	%Si	%Ni
<b>Requirements - AWS ER80S-D2, ER90S-D2</b>	0.07-0.12	1.60-2.10	0.50-0.80	0.15 max
<b>Typical Results<sup>(3)</sup></b>	0.09-0.11	1.63-1.74	0.56-0.64	≤ 0.04
	%Mo	%S	%P	%Cu (Total) <sup>(4)</sup>
<b>Requirements - AWS ER80S-D2, ER90S-D2</b>	0.40-0.60	0.025 max	0.025 max	0.50 max
<b>Typical Results<sup>(3)</sup></b>	0.43-0.46	≤ 0.010	0.007-0.016	0.16-0.22

**TYPICAL OPERATING PROCEDURES**

Diameter, Polarity Shielding Gas	CTWD <sup>(5)</sup> mm (in)	Wire Feed Speed m/min (in/min)	Voltage (volts)	Approx. Current (amps)	Melt-Off Rate kg/hr (lb/hr)
<b>0.035 in (0.9 mm), DC+</b>					
Short Circuit Transfer 75% Ar/25% CO <sub>2</sub> <sup>(6)</sup>	9-12 (3/8-1/2)	2.5 (100)	18	80	0.7 (1.6)
		3.8 (150)	19	120	1.1 (2.4)
		6.4 (250)	22	175	1.8 (4.0)
Spray Transfer 90% Ar/10% CO <sub>2</sub>	12-19 (1/2-3/4)	9.5 (375)	23	195	2.7 (6.0)
		12.7 (500)	29	230	3.6 (8.0)
		15.2 (600)	30	275	4.4 (9.6)
<b>0.045 in (1.1 mm), DC+</b>					
Short Circuit Transfer 75% Ar/25% CO <sub>2</sub> <sup>(6)</sup>	12-19 (1/2-3/4)	3.2 (125)	19	145	1.5 (3.4)
		3.8 (150)	20	165	1.8 (4.0)
		5.1 (200)	21	200	2.5 (5.4)
Spray Transfer 90% Ar/10% CO <sub>2</sub>	12-19 (1/2-3/4)	8.9 (350)	27	285	4.2 (9.2)
		12.1 (475)	30	335	5.7 (12.5)
		12.7 (500)	30	340	6.0 (13.2)
<b>0.052 in (1.3 mm), DC+</b>					
Spray Transfer 90% Ar/10% CO <sub>2</sub>	12-19 (1/2-3/4)	7.6 (300)	30	300	4.8 (10.6)
		8.1 (320)	30	320	5.2 (11.5)
		12.3 (485)	32	430	7.8 (17.1)
<b>1/16 in (1.6 mm), DC+</b>					
Spray Transfer 90% Ar/10% CO <sub>2</sub>	12-25 (1/2-1)	5.3 (210)	25	325	4.8 (10.7)
		6.0 (235)	27	350	5.4 (12.0)
		7.4 (290)	28	430	6.7 (14.8)

<sup>(1)</sup>Typical all weld metal. <sup>(2)</sup>Measured with 0.2% offset. <sup>(3)</sup>See test results disclaimer. <sup>(4)</sup>Copper due to any coating on the electrode plus the copper content of the filler metal itself, shall not exceed the stated 0.50% max. <sup>(5)</sup>CTWD (Contact Tip to Work Distance). Subtract 1/4 in (6.4 mm) to calculate Electrical Stickout. <sup>(6)</sup>Procedures in these areas are procedures for short circuiting mode using 75% Argon, 25% CO<sub>2</sub>. NOTE: For 100% CO<sub>2</sub> procedures, add 1 to 2 volts for short circuit transfer and 2 to 3 volts for globular transfer.

# SUPERARC® LA-100™

Low Alloy, Copper Coated ■ AWS ER100S-G, ER110S-G & EM2

## KEY FEATURES

- Capable of producing welds with 690 MPa (100 ksi) tensile strength
- Excellent for welding quenched and tempered steels and HY-80 base materials
- Supports short-circuiting, globular, axial spray and pulsed spray transfer
- Copper coating provides superior arc-starting characteristics for long contact tip life

## WELDING POSITIONS

All

## SHIELDING GAS

75-95% Argon / Balance CO<sub>2</sub>  
 95-98% Argon / Balance O<sub>2</sub>  
 Flow Rate: 30 - 50 CFH

## CONFORMANCES

**AWS A5:** ER100S-G, ER110S-G  
**ABS:** 4YQ550SA  
**CWB/CSA:** ER100S-G  
**ISO:** SZ

## TYPICAL APPLICATIONS

- HY-80 base material
- ASTM A514, A543, A724 and A782 quenched and tempered plate
- Various heat input conditions
- Military low alloy applications

## DIAMETERS / PACKAGING

Diameter in (mm)	33 lb (15 kg) Steel Spool	44 lb (20 kg) Steel Spool	60 lb (27.2 kg) Coil	500 lb (227 kg) Accu-Trak® Drum	500 lb (227 kg) Accu-Pak® Box
0.035 (0.9)		EDS30778		ED031445	
0.045 (1.1)	ED031417	EDS30779		EDS01162	ED036608
1/16 (1.6)			ED010996		

## MECHANICAL PROPERTIES<sup>(1)</sup> – As Required per AWS A5.28

	Yield Strength <sup>(2)</sup> MPa (ksi)	Tensile Strength MPa (ksi)	Elongation %	Charpy V-Notch J (ft-lbf)	
				@ -18°C (0°F)	@ -51°C (-60°F)
<b>Requirements</b> - AWS ER100S-G As-Welded - Gas Not Specified	Not Specified	690 (100) min	Not Specified	Not Specified	Not Specified
AWS ER110S-G As-Welded - Gas Not Specified	Not Specified	760 (110) min	Not Specified	Not Specified	Not Specified
MIL-100S-1 per MIL-E-23765/2C, 2D, 2E & T9074-BC-G1B-010/0200 As-Welded with 98% Ar / 2% O <sub>2</sub>	565-825 (82-120)	Not Specified	16 min.	81 (60) min	47 (35) min
<b>Typical Results</b> <sup>(3)</sup> As-Welded at 30 kJ/in with 95% Ar/5% CO <sub>2</sub> As-Welded at 45 kJ/in with 98% Ar/2% O <sub>2</sub>	750 (109) 730 (106)	790 (115) 780 (114)	22 20	164 (121) - -	138 (102) 118 (87)
Pulse As-Welded at 110 kJ/in with 95% Ar/5% CO <sub>2</sub>	580 (84)	745 (108)	25	138 (102)	70 (52)
CV As-Welded at 110 kJ/in with 95% Ar/5% CO <sub>2</sub> As-Welded at 45 kJ/in with 95% Ar/5% CO <sub>2</sub>	620 (90) 682 (99)	740 (107) 765 (111)	25 20	170 (125) - -	106 (78) 117 (86)

<sup>(1)</sup>Typical all weld metal. <sup>(2)</sup>Measured with 0.2% offset. <sup>(3)</sup>See test results disclaimer

**WIRE COMPOSITION – As Required per AWS A5.28**

	%C	%Mn	%Si	%Ni	%Mo
<b>Requirements</b> - AWS ER100S-G, ER110S-G	-	-	-	(A)	(A)
<b>Typical Results</b> <sup>(3)</sup>	0.05-0.06	1.63-1.69	0.46-0.50	1.88-1.96	0.43-0.45
	%Cr	%S	%P	%V	
<b>Requirements</b> - AWS ER100S-G, ER110S-G	(A)	-	-	-	
<b>Typical Results</b> <sup>(3)</sup>	0.04-0.06	0.002-0.005	0.005-0.009	≤ 0.01	
	%Al	%Ti	%Zr	%Cu	
<b>Requirements</b> - AWS ER100S-G, ER110S-G	-	-	-	-	
<b>Typical Results</b> <sup>(3)</sup>	≤ 0.01	0.03-0.04	≤ 0.01	0.11-0.14	

(A) Must have the minimum of one or more of the following: 0.50% Ni, 0.30% Cr, or 0.20% Mo.

**TYPICAL OPERATING PROCEDURES**

Diameter, Polarity Shielding Gas	CTWD <sup>(5)</sup> mm (in)	Wire Feed Speed m/min (in/min)	Voltage (volts)	Approx. Current (amps)	Melt-Off Rate kg/hr (lb/hr)
<b>0.035 in (0.9 mm), DC+</b>					
Short Circuit Transfer 75% Ar/25% CO <sub>2</sub>	9-12 (3/8-1/2)	2.5 (100)	18	80	0.7 (1.6)
		3.8 (150)	19	120	1.1 (2.4)
		6.4 (250)	22	175	1.8 (4.0)
Spray Transfer 90% Ar/10% CO <sub>2</sub>	9-12 (3/8-1/2)	9.5 (375)	23	195	2.7 (6.0)
		12.7 (500)	29	230	3.6 (8.0)
		15.2 (600)	30	275	4.4 (9.6)
<b>0.045 in (1.1 mm), DC+</b>					
Pulsed Spray Transfer <sup>(5)</sup>	12-19 (1/2-3/4)	5.1 (200)	19-21	130	2.4 (5.4)
		6.4 (250)	20-23	140	3.0 (6.7)
Spray Transfer 98% Ar/2% O <sub>2</sub> 95% Ar/5% CO <sub>2</sub>	12-19 (1/2-3/4)	8.9 (350)	27	285	4.2 (9.2)
		12.1 (475)	30	335	5.7 (12.5)
		12.7 (500)	30	340	6.0 (13.2)
<b>1/16 in (1.6 mm), DC+</b>					
Spray Transfer 98% Ar/2% O <sub>2</sub> 95% Ar/5% CO <sub>2</sub>	12-25 (1/2-1)	5.3 (210)	25	325	4.8 (10.7)
	12-25 (1/2-1)	6.0 (235)	27	350	5.4 (12.0)
		7.4 (290)	28	430	6.7 (14.8)

<sup>(1)</sup>Typical all weld metal. <sup>(2)</sup>Measured with 0.2% offset. <sup>(3)</sup>See test results disclaimer <sup>(4)</sup>CTWD (Contact Tip to Work Distance). Subtract 1/4 in (6.4 mm) to calculate Electrical Stickout.

<sup>(5)</sup>Procedures in this area are for pulse MIG mode for welding in the vertical up and overhead welding positions. Actual results are dependent on joint, material thickness, as well as wave shape and pulse frequency.

# SUPERARC® AK-10®

Low Alloy, Copper Coated ▪ AWS ER100S-G

## KEY FEATURES

- Capable of producing welds with 690 MPa (100 ksi) tensile strength
- Suitable for use where consumables with less than 1% Ni are required
- Batch Managed Inventory
- MicroGuard® Ultra provides superior feeding and arc stability
- Q2 Lot® - Certificates showing actual wire chemistry available online
- Copper coating provides superior arc-starting characteristics for long contact tip life

## WELDING POSITIONS

All

## SHIELDING GAS

100% CO<sub>2</sub>  
 75-95% Argon / Balance CO<sub>2</sub>  
 95-98% Argon / Balance O<sub>2</sub>  
 Flow rate: 30-50CFH

## CONFORMANCES

AWS A5: ER100S-G

## TYPICAL APPLICATIONS

- NACE applications
- Oil tools
- Riser systems
- High-strength pipe

## TYPICAL BASE METALS

HY-80 or HY-100 per MIL-S-16216, A514 Grade B or P, AISI 4130 or 8620, API X-70 or X-80

## DIAMETERS / PACKAGING

Diameters in (mm)	33 lb (15kg) Steel Spool	500 lb (227kg) Accu-Trak® Drum
0.035 (0.9)	ED034894	ED034896
0.045 (1.1)	ED034895	ED034897

## WIRE COMPOSITION – As Required per AWS A5.28

	%C	%Mn	%Si	%Ni	%Mo	%Cr
Requirements - AWS A5.28: ER100S-G	–	–	–	(A)	(A)	(A)
Typical Results	0.10	1.55	0.57	0.88	0.47	0.28
	%S	%P	%V	%Al	%Cu	
Requirements - AWS A5.28: ER100S-G	–	–	–	–	–	
Typical Results	< 0.005	0.01	< 0.003	0.003	0.12	

(A) Must have the minimum of one or more of the following: 0.50% Ni, 0.30% Cr, or 0.20% Mo. <sup>(1)</sup>Typical all weld metal.

**MECHANICAL PROPERTIES<sup>(1)</sup> – As Required per AWS A5.28**

	Yield Strength <sup>(2)</sup> MPa (ksi)	Tensile Strength MPa (ksi)	Elongation (%)	Charpy V-Notch J (ft-lbf)	
				-40°C (40°F)	-51°C (60°F)
<b>Requirements</b> AWS A5.28: ER100S-G As-Welded with 90% Ar/10% CO <sub>2</sub>	Not Specified	690 (100) min	Not Specified	Not Specified	Not Specified
<b>Typical Results</b> As-Welded with 90% Ar/10% CO <sub>2</sub>	709 (103)	802 (116)	21	86 (64)	85 (63)
Stress Relieved 1 hr. @ 621°C (1150°F) with 90% Ar/10% CO <sub>2</sub>	627 (91)	723 (105)	25	113 (83)	100 (73)

**TYPICAL OPERATING PROCEDURES**

Diameter, Polarity Shielding Gas	CTWD <sup>(4)</sup> mm (in)	Wire Feed Speed m/min (in/min)	Voltage (volts)	Approx. Current (amps)	Melt-Off Rate kg/hr (lb/hr)
<b>0.035 in (0.9 mm), DC+</b>					
Short Circuit Transfer 90% Ar/10% CO <sub>2</sub>	9-12 (3/8-1/2)	2.5 (100)	18	80	0.7 (1.6)
		3.8 (150)	19	120	1.1 (2.4)
		6.4 (250)	22	175	1.8 (4.0)
Spray Transfer 90% Ar/10% CO <sub>2</sub>	9-12 (3/8-1/2)	9.5 (375)	23	195	2.7 (6.0)
		12.7 (500)	29	230	3.6 (8.0)
		15.2 (600)	30	275	4.4 (9.6)
<b>0.045 in (1.1 mm), DC+</b>					
Pulsed Spray Transfer <sup>(5)</sup>	12-19 (1/2-3/4)	5.1 (200)	19-21	130	2.4 (5.4)
		6.4 (250)	20-23	140	3.0 (6.7)
Spray Transfer 98% Ar/2% O <sub>2</sub> 95% Ar/5% CO <sub>2</sub>	12-19 (1/2-3/4)	8.9 (350)	27	285	4.2 (9.2)
		12.1 (475)	30	335	5.7 (12.5)
		12.7 (500)	30	340	6.0 (13.2)
<b>0.052 in (1.3 mm), DC+</b>					
Spray Transfer 98% Ar/2% O <sub>2</sub> 95% Ar/5% CO <sub>2</sub>	12-25 (1/2-1)	5.3 (210)	25	325	4.8 (10.7)
		6.0 (235)	27	350	5.4 (12.0)
		7.4 (290)	28	430	6.7 (14.8)

<sup>(1)</sup>Typical all weld metal. <sup>(2)</sup>Measured with 0.2% offset. <sup>(3)</sup>See test results disclaimer <sup>(4)</sup>CTWD (Contact Tip to Work Distance). Subtract 1/4 in (6.4 mm) to calculate Electrical Stickout.

<sup>(5)</sup>Procedures in this area are for pulse MIG mode for welding in the vertical up and overhead welding positions. Actual results are dependent on joint, material thickness, as well as wave shape and pulse frequency.



# SUPERGLAZE™ SiBR

Copper Alloys ▪ AWS ERCuSi-A / ISO Cu 6560

## KEY FEATURES

- Silicon Bronze is designed for MIG brazing galvanized steel and other applications where a high quality finish is demanded
- High corrosion resistance
- Suitable for GMAW, laser and plasma brazing

## WELDING POSITIONS

All positions

## SHIELDING GAS

100% Argon  
Flow Rate: 30 - 50 CFH

## CONFORMANCES

**AWS A5.7** ERCuSi-A  
**ISO 24373** S Cu 6560 (CuSi3Mn1)

## TYPICAL APPLICATIONS

- Automotive components
- Galvanized steel
- Dissimilar metals
- Copper alloys with similar composition and brass
- Car body construction

## DIAMETERS / PACKAGING

Diameter in (mm)	33 lb (15 kg) Plastic Spool	500 lb (227 kg) Gem-Pak® Box
0.035 (0.9)	ED036805	ED036802
0.040 (1.0)	ED036806	ED036803
0.045 (1.1)	ED036807	ED036804

## MECHANICAL PROPERTIES<sup>(1)</sup>

	Yield Strength <sup>(2)</sup> MPa (ksi)	Tensile Strength MPa (ksi)	Elongation %	Hardness HB
<b>Requirements</b> - AWS ERCuSi-A	-	-	-	-
<b>Typical Results<sup>(3)</sup></b> - As-Welded	182.7 (26.50)	374.0 (54.25)	58.8	89.6

## WIRE COMPOSITION – As Required per ISO 24373

	%Al	%Mn	%Si	%Sn	%P
<b>Requirements</b> - S Cu 6560	0.02	0.5-1.5	2.8-4.0	0.2	0.05
<b>Typical Results<sup>(3)</sup></b>	0.002	0.65	2.97	0.005	0.0007
	%Pb	%Fe	%Zn	Other	
<b>Requirements</b> - S Cu 6560	0.02	0.5	0.4	0.5	
<b>Typical Results<sup>(3)</sup></b>	0.003	0.01	0.02	-	

## TYPICAL OPERATING PROCEDURES<sup>(4)</sup>

Diameter in (mm)	Wire Feed Speed in/min (m/min)	Voltage (volts)	Current (Amps)	Argon Gas Flow (CFH)
0.035 (0.9)	400-440 (10-11)	23-25	145-185	30 - 50 CFH
0.040 (1.0)	340-375 (8-9)	24-26	170-200	
0.045 (1.1)	280-310 (7-8)	26-28	195-215	

<sup>(1)</sup> Typical all weld metal <sup>(2)</sup> Measured with 0.2% offset <sup>(3)</sup> See test results disclaimer <sup>(4)</sup> Suggested parameters are basic guidelines that will vary according to joint design, number of passes and other aspects.

# 2NI

Low Alloy Steel ■ AWS ER80S-Ni2

## KEY FEATURES

- Formulated to match the characteristics of weathering steel
- Developed for superior fracture toughness in as-welded joints in temperatures in the -60 °C (-76 °F) region

## WELDING POSITIONS

All

## SHIELDING GAS

100% Argon

## CONFORMANCES

AWS 5.28: ER80S-Ni2

## TYPICAL APPLICATIONS

- Storage Tanks
- Process Plants
- Pipework

## DIAMETERS / PACKAGING

Diameter mm (in)	5 kg (11 lb) Tube
2.4 (3/32)	T2NI-24

## MECHANICAL PROPERTIES<sup>(1)</sup> – As Required per AWS A5.28

	Yield Strength <sup>(2)</sup> MPa (ksi)	Tensile Strength MPa (ksi)	Elongation %	Charpy V-Notch J (ft-lbf)		Hardness HV
				@-60°C (-76°F)	@-101°C (-150°F)	
<b>Requirements</b> AWS ER80S-Ni2	470 min	550 min	24 min	27 min	-	-
<b>Typical Results<sup>(3)</sup></b> As-Welded <sup>(4)</sup>	452	556	35	200	34	185

## WIRE COMPOSITION<sup>(1)</sup> – As Required per AWS A5.28

	%C	%Mn	%Si	%S
<b>Requirements</b> AWS ER80S-Ni2	0.06-0.12	0.8-1.25	0.40-0.80	0.025 max
<b>Typical Results<sup>(3)</sup></b>	0.08	1	0.5	0.010
	%P	%Cu	%Ni	
<b>Requirements</b> AWS ER80S-Ni2	0.025 max	0.35 max	2.0-2.75	
<b>Typical Results<sup>(3)</sup></b>	0.010	0.10	2.5	

<sup>(1)</sup> Typical all weld metal <sup>(2)</sup> Measured with 0.2% offset <sup>(3)</sup> See test results disclaimer <sup>(4)</sup> Post Weld Heat Treated (PWHT) per AWS Specification

# 5CRMO

Low Alloy Steel ▪ AWS ER80S-B6

## KEY FEATURES

- Developed for 5%Cr-0.50%Mo creep resisting steels
- Designed for high strength and improved corrosion resistance with hot hydrogen gas, super-heated steam, and Sulphur crude oil

## WELDING POSITIONS

All

## SHIELDING GAS

100% Argon

## CONFORMANCES

AWS 5.28: ER80S-B6

BS EN ISO 21952-A CrMo5Si

## TYPICAL APPLICATIONS

- Pressure Vessels
- Piping
- Heat Exchangers

## DIAMETERS / PACKAGING

Diameter mm (in)	5 kg (11 lb) Tube
2.4 (3/32)	T5CRMO-24
3.2 (1/8)	T5CRMO-32

## MECHANICAL PROPERTIES<sup>(1)</sup> – As Required per AWS A5.28

	Yield Strength <sup>(2)</sup> MPa (ksi)	Tensile Strength MPa (ksi)	Elongation %	Charpy V-Notch J (ft·lbf) @20°C (68°F)	Hardness HV
<b>Requirements</b> AWS ER80S-B6	470 (68) min	590 (86) min	17 min	-	-
<b>Typical Results<sup>(3)</sup></b> As-Welded	530 (77)	640 (93)	28	240	195

## WIRE COMPOSITION<sup>(1)</sup> – As Required per AWS A5.28

	%C	%Mn	%Si	%S	%P
<b>Requirements</b> AWS ER80S-B6	0.03-0.10	0.40-0.70	0.30-0.50	0.02 max	0.02 max
<b>Typical Results<sup>(3)</sup></b>	0.07	0.5	0.4	0.01	0.01
	%Cr	%Ni	%Mo	%Cu	%V
<b>Requirements</b> AWS ER80S-B6	5.5-6.0	0.3 max	0.50-0.65	0.3 max	0.03 max
<b>Typical Results<sup>(3)</sup></b>	5.7	0.1	0.55	0.2	0.02

<sup>(1)</sup> Typical all weld metal <sup>(2)</sup> Measured with 0.2% offset <sup>(3)</sup> See test results disclaimer

# 9CRMV-N

Low Alloy Steel ■ AWS ER90S-B9

## KEY FEATURES

- Improved long term creep properties
- Can weld equivalent (P91) 9CrMoV steels

## CONFORMANCES

**AWS A5.28:** ER90S-B9  
**BS EN ISO 21952-A** W CrMo91

## WELDING POSITIONS

All

## TYPICAL APPLICATIONS

- Power Plants
- Elevated Temperature Piping
- Turbine Castings
- Oil Refineries

## DIAMETERS / PACKAGING

Diameter mm (in)	5 kg (11 lb) Tube
2.4 (3/32)	ED033377, T9CRMV-N-24*
3.2 (1/8)	ED033378, T9CRMV-N-32*

\*The Metrode part number will be replacing the current EDO numbers after the inventory has been depleted.

## MECHANICAL PROPERTIES<sup>(1)</sup> - As Required per AWS A5.28

	Yield Strength <sup>(2)</sup> MPa (ksi)	Tensile Strength MPa (ksi)	Elongation %		Charpy V-Notch J (ft·lbf) @ 20°C (68°F)	Hardness HV <sub>10</sub> <sup>(4)</sup>
			4.0 dia.	5.0 dia.		
<b>Requirements</b> AWS ER90S-B9	415 (60) min	620 (90) min	16 min	17 min	–	–
<b>Typical Results<sup>(3)</sup></b> Stress-Relieved @ 760°C (1400°F) for 2 hrs	675 (98)	780 (113)	22	19	220 (162)	265

## WIRE COMPOSITION<sup>(1)</sup> - As Required per AWS A5.28

	%C	%Mn	%Si	%S	%P	%Cr	%Ni
<b>Requirements</b> AWS ER90S-B9	0.08 - 0.13	0.40 - 0.80	0.15 - 0.50	0.010 max	0.010 max	8.5 - 9.5	0.40 - 0.80
<b>Typical Results<sup>(3)</sup></b>	0.10	0.50	0.25	0.006	0.008	8.7	0.60
	%Mo	%Nb	%V	%N	%Cu	%Al	
<b>Requirements</b> AWS ER90S-B9	0.85 - 1.10	0.03 - 0.08	0.15 - 0.25	0.03 - 0.07	0.10 max	0.40 max	
<b>Typical Results<sup>(3)</sup></b>	1.00	0.05	0.20	0.05	0.03	<0.01	

## TYPICAL OPERATING PROCEDURES

Polarity	Amperage mm (in)	
	2.5 (3/32)	3.2 (1/8)
DC-	70 - 110	80 - 140

<sup>(1)</sup>Typical all weld metal. <sup>(2)</sup>Measured with 0.2% offset. <sup>(3)</sup>See test results disclaimer <sup>(4)</sup>Industry specific data, not required by AWS.  
 NOTE: Additional test data available upon request.

# LINCOLN® AK-10®

Low Alloy Steel ▪ AWS ER100S-G

## KEY FEATURES

- Capable of producing welds with 690 MPa (100 ksi) tensile strength
- Suitable for use where consumables with less than 1% Ni are required
- Batch Managed Inventory
- Q2 Lot® - Certificates showing actual wire chemistry available online
- Ink jet printing identification on entire length of electrode

## WELDING POSITIONS

All

## CONFORMANCES

AWS A5: ER100S-G

## TYPICAL APPLICATIONS

- NACE applications
- Oil tools
- Riser systems
- High-strength pipe

## TYPICAL BASE METALS

HY-80 or HY-100 per MIL-S-16216, A514 Grade B or P, AISI 4130 or 8620, API X-70 or X-80

## SHIELDING GAS

100% Argon

## DIAMETERS / PACKAGING

Diameters in (mm)	10 lb. (4.5 kg) Plastic Tube 30 lb (13.6 kg) Master Carton
1/16 (1.6)	ED034898
3/32 (2.4)	ED034899
1/8 (3.2)	ED034900

## WIRE COMPOSITION<sup>(1)</sup> - As Required per AWS A5.28

	%C	%Mn	%Si	%Ni	%Mo	%Cr
Requirements - AWS ER100S-G	—	—	—	(A)	(A)	(A)
Typical Results <sup>(3)</sup>	0.10	1.55	0.57	0.88	0.48	0.27
	%S	%P	%V	%Al	%Cu	
Requirements - AWS ER100S-G	—	—	—	—	—	
Typical Results <sup>(3)</sup>	< 0.005	0.01	< 0.003	0.004	0.09	

(A) Must have the minimum of one or more of the following: 0.50% Ni, 0.30% Cr, or 0.20% Mo. <sup>(3)</sup>See test results disclaimer

# LINCOLN® ER80S-B2

Low Alloy Steel ▪ AWS ER80S-B2

## KEY FEATURES

- Designed for welding 1.25% chromium, 0.5% molybdenum steels in high temperatures service applications such as pressure vessels or piping
- Designed for high temperature power generation applications
- Trace elements are controlled to ensure low Bruscato factor (X-Factor < 15 ppm)
- Q2 Lot® - Certificates showing actual wire chemistry available online
- Ink jet printing identification on entire length of electrode

## WELDING POSITIONS

All

## CONFORMANCES

AWS A5: ER80S-B2

## TYPICAL APPLICATIONS

- Steam piping
- Turbine castings

## SHIELDING GAS

100% Argon

## DIAMETERS / PACKAGING

Diameter in (mm)	10 lb (4.5 kg) Plastic Tube 30 lb (13.6 kg) Master Carton
1/16 (1.6)	ED034343
3/32 (2.4)	ED034344
1/8 (3.2)	ED034345

## WIRE COMPOSITION<sup>(1)</sup> – As Required per AWS A5.28

	%C	%Mn	%Si	%Cr	%Mo	%S	%P	%Cu
Requirements - AWS ER80S-B2	0.07-0.12	0.45-1.00	0.05-0.30	1.00-1.75	0.45-0.65	0.025	0.025	0.35

# LINCOLN® ER80S-D2

Low Alloy Steel ▪ AWS ER80S-D2

## KEY FEATURES

- Capable of producing weld deposits with 550 MPA (80 KSI) tensile strength
- Contains 0.50% molybdenum for strength after stress valves
- Q2 Lot® - Certificates showing actual wire chemistry available online
- Ink jet printing identification on entire length of electrode

## WELDING POSITIONS

All

## CONFORMANCES

**AWS A5:** ER80S-D2, ER90S-D2

## TYPICAL APPLICATIONS

- Requirements for strengths after stress relieving
- ASTM A182, A217, A234 and A335 - High temperature service pipe, fittings, flanges and valves
- ASTM A336 pressure vessel forgings

## SHIELDING GAS

100% Argon

## DIAMETERS / PACKAGING

Diameter in (mm)	10 lb (4.5 kg) Plastic Tube 30 lb (13.6 kg) Master Carton
1/16 (1.6)	ED034219
3/32 (2.4)	ED034220
1/8 (3.2)	ED034221

## WIRE COMPOSITION<sup>(1)</sup> – As Required per AWS A5.28

	%C	%Mn	%Si	%S
<b>Requirements</b> - AWS ER80S-D2	0.07-0.12	1.60-2.10	0.50-0.80	0.025 max
	%P	%Cu <sup>(4)</sup>	%Ni	%Mo
<b>Requirements</b> - AWS ER80S-D2	0.025 max	0.50 max	0.15 max	0.40 max

<sup>(4)</sup>Copper due to any coating on the electrode plus the copper content of the filler metal itself, shall not exceed the stated 0.50% max.

# LINCOLN® ER80S-Ni1

Low Alloy Steel ■ AWS ER80S-Ni1

## KEY FEATURES

- Capable of producing weld deposits with 550 MPA (80 KSI) tensile strength
- High toughness at low temperatures with a nominal 1% Ni or less
- Q2 Lot® - Certificates showing actual wire chemistry available online
- Ink jet printing identification on entire length of electrode

## WELDING POSITIONS

All

## CONFORMANCES

AWS A5: ER80S-Ni1

## TYPICAL APPLICATIONS

- ASTM A588 weathering steel requiring good atmospheric corrosion resistance
- NACE applications

## SHIELDING GAS

100% Argon

## DIAMETERS / PACKAGING

Diameter in (mm)	10 lb (4.5 kg) Plastic Tube 30 lb (13.6 kg) Master Carton
1/16 (1.6)	ED034346
3/32 (2.4)	ED034347
1/8 (3.2)	ED034348

## WIRE COMPOSITION<sup>(1)</sup> – As Required per AWS A5.28

	%C	%Mn	%Si	%Ni	%Cr
<b>Requirements</b> - AWS ER80S-Ni1	0.12 max	1.25 max	0.40-0.80	0.80-1.10	0.15 max
<b>Typical Results</b> <sup>(3)</sup>	0.07-0.08	0.94-1.04	0.54-0.58	0.88-0.98	≤ 0.04
	%Mo	%S	%P	%V	%Cu (Total) <sup>(4)</sup>
<b>Requirements</b> - AWS ER80S-Ni1	0.035 max	0.025 max	0.025 max	0.05 max	0.35 max
<b>Typical Results</b> <sup>(3)</sup>	≤ 0.02	0.007-0.10	0.005-0.010	< 0.01	0.16-0.21

<sup>(3)</sup>See test results disclaimer <sup>(4)</sup>Copper due to any coating on the electrode plus the copper content of the filler metal itself, shall not exceed the stated 0.50% max.



# LINCOLN® ER90S-B3

Low Alloy Steel ■ AWS ER90S-B3

## KEY FEATURES

- High strength filler metal used for precision welding of 2.25% Cr – 1% Mo high pressure piping, pressure vessels, and dissimilar combinations of Cr-Mo and carbon steels
- Designed to sustain elevated temperatures within demanding work environments
- Produced to the most stringent quality standards including AWS A.5.28 and ASME SFA-5.28
- Trace elements are controlled to ensure low Bruscato factor (X-Factor < 10 ppm)
- Q2 Lot® - Certificates showing actual wire chemistry available online
- Ink jet printing identification on entire length of electrode

## WELDING POSITIONS

All

## CONFORMANCES

AWS A5: ER90S-B3

## TYPICAL APPLICATIONS

- Power Generation, Nuclear Industries

## SHIELDING GAS

100% Argon

## DIAMETERS / PACKAGING

Diameter in (mm)	10 lb (4.5 kg) Plastic Tube 30 lb (13.6 kg) Master Carton
1/16 (1.6)	ED034357
3/32 (2.4)	ED034358
1/8 (3.2)	ED034359

## MECHANICAL PROPERTIES<sup>(1)</sup> – As Required per AWS A5.28

	Yield Strength <sup>(2)</sup> MPa (ksi)	Tensile MPa (ksi)	Elongation on 4d (%)	Charpy V-Notch @-28°C (-20°F) J (ft-lbf)	Hardness (Rockwell B)
Requirements - AWS A5.28	540 (78) min	620 (90) min	17 min	-	-
TIG (100% Argon)	575-620 (83-90)	690-725 (100-105)	22-24	250-264 (185-195)	95-97

## WIRE COMPOSITION<sup>(1)</sup> – As Required per AWS A5.28

	%C	%Mn	%Si	%S	%P	%Cr	%Ni	%Mo	%Cu
Requirements AWS ER90S-B3	0.07-0.12	0.40-0.70	0.40-0.70	0.025 max	0.025 max	2.30-2.70	0.20 max	0.90-1.20	0.35 max
Test Results <sup>(3)</sup>	0.10	0.56-0.58	0.53-0.54	0.003-0.004	0.005	2.4	0.03-0.04	1.02-1.04	0.06-0.08

<sup>(1)</sup>Typical all weld metal. <sup>(2)</sup>Measured with 0.2% offset. <sup>(3)</sup>See test results disclaimer

# LINCOLN® LA-84

Low Alloy Steel ▪ AWS ER90S-G

## KEY FEATURES

- A nickel-bearing electrode with 0.5% molybdenum
- Available as Batch Managed Inventory
- Can be used for higher strength weldments where impact properties exceeding 27 J (20 ft•lbf) at -62°C (-80°F) are required
- Suitable for use where consumables with less than 1% Ni are required
- Ink jet printing identification on entire length of electrode

## WELDING POSITIONS

All

## CONFORMANCES

AWS A5.28: ER90S-G

## TYPICAL APPLICATIONS

- Low temperature toughness requirements
- NACE

## SHIELDING GAS

100% Argon

## DIAMETERS / PACKAGING

Diameter in (mm)	10 lb (4.5 kg) Plastic Tube 30 lb (13.6 kg) Master Carton
1/16 (1.6)	ED034349
3/32 (2.4)	ED034350
1/8 (3.2)	ED034351

## WIRE COMPOSITION<sup>(1)</sup> – As Required per AWS A5.28

	%C	%Mn	%Si	%S	%P	%Ni	%Mo	%Cu
Requirements - AWS ER90S-G	0.10-0.18	1.75-2.20	0.2	0.010-0.020	0.010-0.020	0.80-1.0	0.45-0.60	0.05-0.15

<sup>(1)</sup>Typical all weld metal.

# TECHALLOY® 4130

Low Alloy Steel

## KEY FEATURES

- High strength, low alloy
- Preheat and inter-pass temperature of 400°F (204.4°C) is required

## WELDING POSITIONS

All

## TYPICAL APPLICATIONS

- Joining steels of similar chemical composition
- Overlays where moderate hardness is required

## SHIELDING GAS

100% Argon

## DIAMETERS / PACKAGING

Diameter in (mm)	TIG 50 lb (22.7 kg) Master Carton
1/16 (1.6)	TG4130062628
3/32 (2.4)	TG4130093628
1/8 (3.2)	TG4130125628

## MECHANICAL PROPERTIES<sup>(4)</sup>

	Yield Strength <sup>(2)</sup> MPa (ksi)	Tensile Strength MPa (ksi)	Elongation %
Typical Results <sup>(3)</sup>	900 (130)	1,000 (145)	11

## WIRE COMPOSITION<sup>(1)</sup>

	%C	%Mn	%Si	%Fe	%Cr	%Mo	%Ni	%V
Typical Results <sup>(3)</sup>	0.31	0.52	0.28	Balance	0.93	0.20	-	-

<sup>(1)</sup>Typical deposit composition. <sup>(2)</sup>Measured with 0.2% offset. <sup>(3)</sup>See test results disclaimer. <sup>(4)</sup>Quenched from 1,550 F (843 C) in oil and tempered at 1,050 F (565 C). Safety Data Sheets (SDS) are available on our website at [www.lincolnelectric.com](http://www.lincolnelectric.com)

# LINCOLN® ER70S-2

Mild Steel, Copper Coated ▪ AWS ER70S-2

## KEY FEATURES

- Contains zirconium, titanium, and aluminum in addition to silicon and manganese
- Produces x-ray quality welds over most surface conditions
- Recommended for TIG welding on all grades of steel
- Ink jet printing identification on entire length of electrode
- Q2 Lot® - Certificates showing actual wire chemistry available online

## WELDING POSITIONS

All

## CONFORMANCES

**AWS A5:** ER70S-2  
**CWB/CSA:** ER70S-2  
**ISO:** W 49 2

## TYPICAL APPLICATIONS

- Repairs on a variety of mild and low alloy steel
- Small diameter pipe and tubing
- Sheet metal applications
- Root pass pipe welding

## SHIELDING GAS

100% Argon

## DIAMETERS / PACKAGING

Diameter in (mm)	10 lb (4.5 kg) Carton	5 lb (2.3 kg) Plastic Tube 20 lb (9.1 kg) Master Carton	10 lb (4.5 kg) Plastic Tube 30 lb (13.6 kg) Master Carton	50 lb (22.7 kg) Carton
1/16 (1.6)	ED033952*	ED034325	ED034328	ED034331
3/32 (2.4)	ED033953*	ED034326	ED034329	ED034332
1/8 (3.2)	ED033954*	ED034327	ED034330	ED034333
5/32 (4.0)			ED034810	

\* Nuclear Tested Product

## WIRE COMPOSITION<sup>(1)</sup> – As Required per AWS A5.18

	%C	%Mn	%S	%Si	%P	%Cu	%Cr
<b>Requirements - AWS ER70S-2</b>	0.07 max	0.90-1.40	0.035 max	0.40-0.70	0.0025 max	0.50 max	(1)
<b>Typical Results<sup>(2)</sup></b>	0.04	1.08	0.005	0.55	0.0003	0.20	0.08
	%Ni	%Mo	%V	%Al	%Ti	%Zr	
<b>Requirements - AWS ER70S-2</b>	(1)	(1)	(1)	0.05-0.15	0.05-0.15	0.02-0.12	
<b>Typical Results<sup>(2)</sup></b>	0.08	0.08	< 0.002	0.08	0.10	0.07	

<sup>(1)</sup>Total 0.50% maximum, combined. <sup>(2)</sup>See test results disclaimer

# LINCOLN® ER70S-6

Mild Steel, Copper Coated ▪ AWS ER70S-6

## KEY FEATURES

- High levels of manganese and silicon deoxidizers tolerate medium to heavy mill scale surfaces
- More puddle fluidity than ER70S-2
- Excellent wetting action
- Ink jet printing identification on entire length of electrode
- Q2 Lot® - Certificates showing actual wire chemistry available online

## WELDING POSITIONS

All

## CONFORMANCES

<b>AWS A5:</b>	ER70S-6
<b>CWB/CSA:</b>	B-G 49A 3 C1 S6
<b>ISO:</b>	W 49 6

## TYPICAL APPLICATIONS

- Repairs on a variety of mild and low alloy steel
- Small diameter pipe and tubing
- Sheet metal applications
- Root pass pipe welding

## SHIELDING GAS

100% Argon

## DIAMETERS / PACKAGING

Diameter in (mm)	5 lb (2.3 kg) Plastic Tube 20 lb (9.1 kg) Master Carton	10 lb (4.5 kg) Plastic Tube 30 lb (13.6 kg) Master Carton	50 lb (22.7 kg) Carton
1/16 (1.6)	ED034334	ED034337	ED034340
3/32 (2.4)	ED034335	ED034338	ED034341
1/8 (3.2)	ED034336	ED034339	ED034342
5/32 (4.0)		ED034781	

## WIRE COMPOSITION<sup>(1)</sup> – As Required per AWS A5.18

	%C	%Mn	%S	%Si	%P
<b>Requirements</b> - AWS ER70S-6	0.06-0.15	1.40-1.85	0.035 max	0.80-1.15	0.025 max
<b>Typical Results</b> <sup>(2)</sup>	0.09	<1.60	0.007	0.90	0.007
	%Cu	%Cr	%Ni	%Mo	%V
<b>Requirements</b> - AWS ER70S-6	0.50 max	(1)	(1)	(1)	(1)
<b>Typical Results</b> <sup>(2)</sup>	0.20	0.05	0.05	0.05	0.05

<sup>(1)</sup>Total 0.50% maximum, combined. <sup>(2)</sup>See test results disclaimer

# METAL-CORED

*GMAW-C Wire*

**Mild Steel**

Metalshield® MC-70 XLS™ .....	C-1
Metalshield® Clarity® MC®-707 .....	C-3
Metalshield® MC-6® .....	C-5
Metalshield® MC®-706 .....	C-7
Metalshield® MC®-706 Buy America .....	C-9
Metalshield® MC-710XL® .....	C-11
Metalshield® Z® .....	C-13

**Low Alloy**

Metalshield® MC-80 XLS™ .....	C-15
Metalshield® MC®-90 .....	C-17
Metalshield® MC®-110 .....	C-19
Metalshield® MC®-120 .....	C-21

# METALSHIELD® MC-70 XLS™

Mild Steel ▪ AWS E70C-6M-H4, E70T15-M21A4-CS1-H4

## KEY FEATURES

- Minimal silicon islands for an exceptionally clean weld surface
- Minimal post weld clean up
- Best-in-class edge wetting for excellent bead appearance
- Smooth, stable arc characteristics with low spatter levels
- Tolerates welding over mill scale and rust
- Low H4 diffusible hydrogen levels
- High deposition rates and fast travel speeds

## WELDING POSITIONS

Flat & Horizontal (CV processes)  
Out of Position (Pulse waveforms)

## CONFORMANCES

**AWS A5:** E70C-6M-H4, E70T15-M20A4-CS1-H4  
E70T15-M21A4-CS1-H4

**CWB/CSA:** E491T15-M21A4-CS1-H4,  
E491T15-M20A4-CS1-H4 (E491C-6MJ-H4)

## TYPICAL APPLICATIONS

- Robotics/Hard Automation
- Structural Fabrication
- Heavy Fabrication
- Pressure Vessels
- Agriculture

## SHIELDING GAS

75-92% Argon / Balance CO<sub>2</sub>  
Flow rate: 40-60 CFH

## DIAMETERS / PACKAGING

Diameter in (mm)	33 lb (15 kg) Steel Spool	750 lb (340 kg) Accu-Trak® Drum
0.045 (1.1)	ED037105	ED037281
0.052 (1.3)	ED037106	ED037282
1/16 (1.6)	ED037107	ED037283

## MECHANICAL PROPERTIES<sup>(1)</sup>

	Yield Strength <sup>(2)</sup> MPa (ksi)	Tensile Strength MPa (ksi)	Elongation %	Charpy V-Notch J (ft•lbf) @ -40°C (-40°F)
Requirements				
<b>AWS A5.18:</b> E70C-6M-H4	400 (58) min	480 (70) min	22 min	27 (20) min
<b>AWS A5.36:</b> E70T15-M20A4-CS1-H4, E70T15-M21A4-CS1-H4		490-660 (70-95)		
Typical Results <sup>(3)</sup>				
As-Welded with 75% Argon / 25% CO <sub>2</sub>	450-510 (65-75)	510-590 (75-85)	26-30	40-75 (30-55)
As-Welded with 90% Argon / 10% CO <sub>2</sub>	450-550 (65-80)	550-620 (80-90)	26-30	60-105 (45-75)

<sup>(1)</sup>Typical all weld metal. <sup>(2)</sup>Measured with 0.2% offset. <sup>(3)</sup>See test results disclaimer.

DEPOSIT COMPOSITION<sup>(1)</sup>

	%C	%Mn	%Si	%S	%P	%Cu
Requirements <b>AWS A5.18:</b> E70C-6M-H4	0.12 max.	1.75 max.	0.90 max.	0.03 max.	0.03 max.	0.50 max.
<b>AWS A5.36:</b> E70T15-M20A4-S1-H4, E70T15-M21A4-CS1-H4				0.030 max.	0.030 max.	
Typical Performance <sup>(3)</sup> As-Welded with 75% Ar / 25% CO <sub>2</sub> As-Welded with 90% Ar / 10% CO <sub>2</sub>	0.04-0.07	1.25-1.55 1.25-1.60	0.55-0.80 0.60-0.85	0.010-0.020	0.005-0.010	0.01-0.05
	%Ni	%Cr	%Mo	%V	Diffusible Hydrogen (mL/100g weld deposit)	
Requirements <b>AWS A5.18:</b> E70C-6M-H4	0.50 max.	0.20 max.	0.30 max.	0.08 max.	4.0 max.	
<b>AWS A5.36:</b> E70T15-M20A4-S1-H4, E70T15-M21A4-CS1-H4					4 max.	
Typical Performance <sup>(3)</sup> As-Welded with 75% Ar / 25% CO <sub>2</sub> As-Welded with 90% Ar / 10% CO <sub>2</sub>	0.30-0.40	0.01-0.03	0.01-0.02	0.01-0.02	2-4	

TYPICAL OPERATING PROCEDURES

Diameter, Polarity Shielding Gas	CTWD <sup>(4)</sup> mm (in)	Wire Feed Speed m/min (in/min)	Voltage <sup>(5)</sup> (volts)	Approx. Current (amps)	Melt-Off Rate kg/hr (lb/hr)	Deposition Rate kg/hr (lb/hr)	Efficiency (%)
0.045 in (1.1 mm), DC+ 90% Argon / 10% CO <sub>2</sub>	19-25 (3/4-1)	5.1 (200)	21-23	155	2.3 (5.0)	2.1 (4.6)	92
		6.4 (250)	22-24	185	2.8 (6.2)	2.6 (5.8)	94
		7.6 (300)	22-26	220	3.5 (7.7)	3.2 (7.0)	91
		8.9 (350)	22-27	245	4.0 (8.9)	3.7 (8.2)	93
		10.2 (400)	23-27	260	4.6 (10.1)	4.3 (9.4)	93
		11.4 (450)	23-28	280	5.2 (11.4)	4.9 (10.7)	94
		12.7 (500)	23-29	305	5.7 (12.6)	5.5 (12.2)	97
		14.0 (550)	24-29	315	6.3 (13.9)	6.2 (13.6)	98
		15.2 (600)	25-30	325	6.8 (15.1)	6.7 (14.8)	98
0.052 in (1.3 mm), DC+ 90% Argon / 10% CO <sub>2</sub>	19-25 (3/4-1)	5.1 (200)	22-24	210	3.1 (6.8)	2.9 (6.3)	94
		6.4 (250)	22-26	260	3.9 (8.5)	3.5 (7.8)	92
		7.6 (300)	22-27	290	4.6 (10.2)	4.3 (9.5)	94
		8.9 (350)	23-28	315	5.4 (11.9)	5.2 (11.4)	97
		10.2 (400)	24-28	350	6.2 (13.6)	6.1 (13.4)	97
		11.4 (450)	25-28	370	6.9 (15.3)	6.8 (15.1)	99
		12.7 (500)	27-29	390	7.7 (17.0)	7.6 (16.8)	99
14.0 (550)	27-30	420	8.4 (18.6)	8.3 (18.3)	99		
1/16 in (1.6 mm), DC+ 90% Argon / 10% CO <sub>2</sub>	25-32 (1-1 1/4)	3.8 (150)	22-24	230	3.2 (7.0)	2.8 (6.2)	89
		5.1 (200)	22-25	280	4.3 (9.4)	3.9 (8.7)	93
		6.4 (250)	23-27	310	5.3 (11.6)	5.0 (11.0)	94
		7.6 (300)	24-28	370	6.3 (13.9)	6.3 (13.8)	99
		8.9 (350)	26-30	400	7.4 (16.3)	7.2 (15.9)	98
		10.2 (400)	26-30	450	8.3 (18.4)	8.3 (18.4)	99
11.4 (450)	27-31	480	9.5 (21.0)	9.3 (20.6)	98		

<sup>(4)</sup>To estimate ESO, subtract 3/16 in (4.8 mm) from CTWD. <sup>(5)</sup>For greater percentage of CO<sub>2</sub> shielding gas, increase voltage by 1-2 volts.



# METALSHIELD® CLARITY® MC® -707

Mild Steel ■ AWS E70C-6M H4

## KEY FEATURES

- Over 40% reduction in Manganese Generation Rate when compared to a conventional E70C-6M electrode
- Assists efforts to reduce exposure to Manganese
- H4 diffusible hydrogen levels
- High deposition rates and fast travel speeds
- Superior arc wetting and bead appearance

## WELDING POSITIONS

Flat & Horizontal

## DIAMETERS / PACKAGING

Diameter in (mm)	33 lb (15 kg) Fiber Spool	500 lb (227 kg) Accu-Trak® Drum (20 in dia.)
0.045 (1.1)	ED036370	ED036491
0.052 (1.3)	ED036371	ED036492
1/16 (1.6)	ED036372	ED036493

## CONFORMANCES

**AWS A5:** E70C-6M-H4, E70T15-M20A4-CS1-H4

**CWB/CSA:** E490T15-M20A3-CS1-H4,  
E490T15-M21A3-CS1-H4

## TYPICAL APPLICATIONS

- Robotics/hard automation
- Structural fabrication
- General fabrication

## SHIELDING GAS

90% Ar, 10% CO<sub>2</sub>  
Flow rate: 40-60 CFH

## MECHANICAL PROPERTIES<sup>(1)</sup> – As Required per AWS A5.18

	Yield Strength <sup>(2)</sup> MPa (ksi)	Tensile Strength MPa (ksi)	Elongation %	Charpy V-Notch J (ft•lbf)	
				@ -29°C (-20°F)	@ -40°C (-40°F)
Requirements - AWS A5.18: E70C-6M-H4	400 (58) min	480 (70) min	22 min	27 (20) min	-
AWS A5.36: E70T15-M20A4-CS1-H4	400 (58) min	490-660 (70-95)	22 min	-	27 (20) min
Typical Results <sup>(3)</sup> As-Welded with 75% Ar / 25% CO <sub>2</sub> <sup>(4)</sup> As-Welded with 90% Ar / 10% CO <sub>2</sub>	440-480 (64-70) 440-500 (64-72)	520-565 (75-82) 525-570 (76-83)	24-31 28-32	30-74 (22-55) 84-149 (62-110)	- 39-146 (23-108)

## DEPOSIT COMPOSITION<sup>(1)</sup> – As Required per AWS A5.18

	%C	%Mn	%Si	%S	%P	%Cu
Requirements - AWS A5.18: E70C-6M-H4	0.12 max	1.75 max	0.90 max	0.03 max	0.03 max	0.50 max
AWS A5.36: E70T15-M20A4-CS1-H4				0.030 max	0.030 max	
Typical Results <sup>(3)</sup> As-Welded with 75% Ar / 25% CO <sub>2</sub> <sup>(4)</sup> As-Welded with 90% Ar / 10% CO <sub>2</sub>	0.03-0.05 0.04-0.06	0.60-0.67 0.61-0.70	0.57-0.65 0.61-0.64	0.011-0.014 0.011-0.013	0.005-0.007 0.005-0.006	0.04-0.05 0.04-0.06
	%Ni	%Cr	%Mo	%V	%B	Diffusible Hydrogen (mL/100g weld deposit)
Requirements - AWS A5.18: E70C-6M-H4	0.50 max	0.20 max	0.30 max	0.08 max	Not Specified	4.0 max
AWS A5.36: E70T15-M20A4-CS1-H4						4 max
Typical Results <sup>(3)</sup> As-Welded with 75% Ar / 25% CO <sub>2</sub> <sup>(4)</sup> As-Welded with 90% Ar / 10% CO <sub>2</sub>	0.02-0.03 0.02	0.03-0.04 0.03-0.04	0.02 0.02	<0.01 <0.01	0.002-0.003 0.003	1-2 1

<sup>(1)</sup>Typical all weld metal. <sup>(2)</sup>Measured with 0.2% offset. <sup>(3)</sup>See test results disclaimer <sup>(4)</sup>Required gas mixture 75-80% Argon/Balance CO<sub>2</sub> for AWS testing.

## TYPICAL OPERATING PROCEDURES

Diameter, Polarity Shielding Gas	CTWD <sup>(5)</sup> mm (in)	Wire Feed Speed m/min (in/min)	Voltage <sup>(6)</sup> (volts)	Approx. Current (amps)	Melt-Off Rate kg/hr (lb/hr)	Deposition Rate kg/hr (lb/hr)	Efficiency (%)
0.045 in (1.1 mm), DC+ 90% Argon / 10% CO <sub>2</sub>	19-25 (3/4-1)	5.1 (200)	21-23	150	2.3 (5.1)	2.1 (4.7)	94-99
		6.4 (250)	22-24	175	2.9 (6.4)	2.7 (6.0)	
		7.6 (300)	22-25	190	3.4 (7.6)	3.3 (7.3)	
		8.9 (350)	23-26	215	4.0 (8.9)	3.9 (8.5)	
		10.2 (400)	24-27	235	4.6 (10.2)	4.5 (9.8)	
		11.4 (450)	24-28	260	5.2 (11.5)	5.0 (11.1)	
		12.7 (500)	24-28	270	5.8 (12.7)	5.6 (12.4)	
		14.0 (550)	25-28	290	6.4 (14.0)	6.2 (13.6)	
		15.2 (600)	25-30	300	6.9 (15.3)	6.8 (14.9)	
16.5 (650)	26-30	320	7.5 (16.6)	7.3 (16.2)			
17.8 (700)	26-31	325	8.1 (17.8)	7.9 (17.5)			
0.052 in (1.3 mm), DC+ 90% Argon / 10% CO <sub>2</sub>	19-25 (3/4-1)	5.1 (200)	22-25	200	3.1 (6.8)	2.9 (6.4)	94-99
		6.4 (250)	22-25	230	3.9 (8.5)	3.7 (8.2)	
		7.6 (300)	23-26	255	4.6 (10.2)	4.5 (9.9)	
		8.9 (350)	24-27	285	5.4 (11.9)	5.3 (11.6)	
		10.2 (400)	24-28	310	6.2 (13.6)	6.1 (13.4)	
		11.4 (450)	25-28	340	6.9 (15.3)	6.8 (15.1)	
		12.7 (500)	27-29	365	7.7 (17.0)	7.6 (16.8)	
		14.0 (550)	28-30	390	8.4 (18.6)	18.5 (18.6)	
1/16 in (1.6 mm), DC+ 90% Argon / 10% CO <sub>2</sub>	25-32 (1-1 1/4)	3.8 (150)	22-24	215	3.1 (6.9)	2.9 (6.3)	94-99
		5.1 (200)	22-25	260	4.2 (9.2)	4.0 (8.7)	
		6.4 (250)	23-27	295	5.2 (11.5)	5.0 (11.1)	
		7.6 (300)	24-28	350	6.2 (13.7)	6.1 (13.5)	
		8.9 (350)	26-30	375	7.3 (16.0)	7.2 (15.9)	
		10.2 (400)	26-30	425	8.3 (18.3)	8.3 (18.3)	
		11.4 (450)	27-31	460	9.3 (20.6)	9.4 (20.7)	

<sup>(1)</sup>Typical all weld metal. <sup>(2)</sup>Measured with 0.2% offset. <sup>(3)</sup>See test results disclaimer <sup>(4)</sup>Required gas mixture 75-80% Argon/Balance CO<sub>2</sub> for AWS testing. <sup>(5)</sup>To estimate ESO, subtract 3/16 in (4.8 mm) from CTWD. <sup>(6)</sup>For greater percentage of CO<sub>2</sub> shielding gas, increase voltage by 1-2 volts. NOTE: This product contains micro-alloying elements. Additional information available upon request.

# METALSHIELD® MC-6®

Mild Steel ▪ AWS E70C-6M H4

## KEY FEATURES

- Excellent performance in fast follow, high travel speed applications
- Optimal wetting action, even at low voltages
- H4 diffusible hydrogen level
- Use with Rapid-Arc® Waveform Control Technology® for increased travel speeds
- Deoxidizing arc action minimizes pre-weld work

## WELDING POSITIONS

All

## SHIELDING GAS

75-95% Argon / Balance CO<sub>2</sub>  
Flow Rate: 40-60 CFH

## CONFORMANCES

**AWS A5:** E70C-6M-H8  
**ISO:** T49 4 T15-1 M A H5

## TYPICAL APPLICATIONS

- Robotics/Hard automation
- Automotive
- Structural fabrication
- Process piping and pressure vessels
- General fabrication

## DIAMETERS / PACKAGING

Diameter in (mm)	33 lb (15 kg) Steel Spool	50 lb (22.7 kg) Fiber Spool	60 lb (27.2 kg) Coil	500 lb (227 kg) Accu-Trak® Drum
0.045 (1.1)	ED030392	ED030554	ED030549	ED031011
0.052 (1.3)	ED030393	ED030556	ED030550	ED030946
1/16 (1.6)	ED030394	ED030555	ED030577	ED030947

## MECHANICAL PROPERTIES<sup>(1)</sup> – As Required per AWS A5.18/A5.36

	Yield Strength <sup>(2)</sup> MPa (ksi)	Tensile Strength MPa (ksi)	Elongation %	Charpy V-Notch J (ft•lbf)	
				@ -29 °C (-20 °F)	@ -40 °C (-40 °F)
Requirements - AWS A5.18: E70C-6M-H4 AWS A5.36: E70T15-M20A4-CS1-H4	400 (58) min	480 (70) min 490-660 (70-95)	22 min	27 (20) min	Not Specified
Typical Results <sup>(3)</sup>					
As-Welded with 75% Argon / 25% CO <sub>2</sub> <sup>(4)</sup>	450-510 (65-75)	510-590 (75-85)	24-28	81-122 (60-90)	47-75 (35-55)
As-Welded with 90% Argon / 10% CO <sub>2</sub>	480-550 (70-80)	550-620 (80-90)	24-28	75-102 (55-75)	61-81 (45-60)

<sup>(1)</sup>Typical all weld metal. <sup>(2)</sup>Measured with 0.2% offset. <sup>(3)</sup>See test results disclaimer <sup>(4)</sup>Required gas mixture 75-80% Argon/Balance CO<sub>2</sub> for AWS testing.

**DEPOSIT COMPOSITION<sup>(1)</sup> – As Required per AWS A5.18/A5.36**

	%C	%Mn	%Si	%S	%P	%Cu	%Ni
Requirements - AWS A5.18: E70C-6M-H4 AWS A5.36: E70T15-M20A4-CS1-H4	0.12 max	1.75 max	0.90 max	0.03 max 0.030 max	0.03 max 0.030 max	0.50 max 0.035 max	0.50 max
Typical Results <sup>(2)</sup>							
As-Welded with 75% Argon / 25% CO <sub>2</sub> <sup>(4)</sup>	0.03-0.05	1.25-1.60	0.40-0.60	0.01-0.02	0.01-0.02	0.01-0.05	0.02-0.05
As-Welded with 90% Argon / 10% CO <sub>2</sub>	0.03-0.05	1.25-1.70	0.40-0.70	0.01-0.02	0.01-0.02	0.01-0.05	0.02-0.05
	%Cr	%Mo	%V	%B	%Ni + %Cr + %Mo + %V	Diffusible Hydrogen (mL/100g weld deposit)	
Requirements - AWS A5.18: E70C-6M-H4 AWS A5.36: E70T15-M20A4-CS1-H4	0.20 max	0.30 max	0.08 max	Not Specified	0.50 max	4.0 max 4 max	
Typical Results <sup>(3)</sup>							
As-Welded with 75% Argon / 25% CO <sub>2</sub> <sup>(4)</sup>	0.01-0.04	0.01-0.02	0.01-0.02	0.004-0.005	0.05-0.10	2-4	
As-Welded with 90% Argon / 10% CO <sub>2</sub>	0.01-0.04	0.01-0.02	0.01-0.02	0.004-0.005	0.05-0.10		

**TYPICAL OPERATING PROCEDURES**

Diameter, Polarity Shielding Gas	CTWD <sup>(5)</sup> mm (in)	Wire Feed Speed m/min (in/min)	Voltage <sup>(6)</sup> (volts)	Approx. Current (amps)	Melt-Off Rate kg/hr (lb/hr)	Deposition Rate kg/hr (lb/hr)	Efficiency (%)
0.045 in (1.1 mm), DC+ 90% Argon / 10% CO <sub>2</sub>	19-25 (3/4-1)	5.1 (200)	21-23	170	2.5 (5.6)	2.3 (5.2)	92
		6.4 (250)	22-25	190	2.9 (6.4)	2.7 (6.1)	95
		7.6 (300)	22-26	210	3.5 (7.8)	3.2 (7.1)	92
		8.9 (350)	22-27	245	4.1 (9.1)	3.9 (8.7)	95
		10.2 (400)	23-27	265	4.6 (10.2)	4.5 (9.9)	97
		12.7 (500)	23-28	300	5.7 (12.6)	5.6 (12.4)	98
		15.2 (600)	25-29	335	7.0 (15.4)	6.9 (15.3)	99
		17.8 (700)	26-30	370	8.1 (17.8)	7.9 (17.5)	98
0.052 in (1.3 mm), DC+ 90% Argon / 10% CO <sub>2</sub>	19-25 (3/4-1)	5.1 (200)	22-24	220	3.2 (7.0)	2.9 (6.4)	92
		6.4 (250)	22-26	260	4.0 (8.7)	3.8 (8.3)	95
		7.6 (300)	22-27	300	4.9 (10.7)	4.7 (10.3)	96
		8.9 (350)	23-27	335	5.6 (12.3)	5.5 (12.0)	98
		10.2 (400)	24-28	360	6.3 (13.9)	6.3 (13.8)	99
		12.7 (500)	27-30	410	7.9 (17.4)	7.8 (17.3)	99
		15.2 (600)	27-31	455	9.5 (21.1)	9.4 (20.8)	99
		1/16 in (1.6 mm), DC+ 90% Argon / 10% CO <sub>2</sub>	25-32 (1-1 1/4)	2.5 (100)	21-24	175	2.1 (4.7)
3.8 (150)	22-25			235	3.2 (7.1)	2.9 (6.4)	90
5.1 (200)	22-26			290	4.3 (9.5)	4.0 (8.9)	94
6.4 (250)	22-28			345	5.4 (11.9)	5.2 (11.4)	96
7.6 (300)	23-29			360	6.4 (14.2)	6.3 (13.9)	98
10.2 (400)	26-31			425	8.5 (18.7)	8.4 (18.5)	99
12.7 (500)	27-32			485	10.8 (23.8)	10.7 (23.5)	99

<sup>(1)</sup>Typical all weld metal. <sup>(2)</sup>Measured with 0.2% offset. <sup>(3)</sup>See test results disclaimer <sup>(4)</sup>Required gas mixture 75-80% Argon/Balance CO<sub>2</sub> for AWS testing. <sup>(5)</sup>To estimate ESO, subtract 3/16 in (4.8 mm) from CTWD. <sup>(6)</sup>For greater percentage of CO<sub>2</sub> shielding gas, increase voltage by 1-2 volts.

# METALSHIELD® MC®-706

Mild Steel ▪ AWS E70C-6M H4

## KEY FEATURES

- High deposition rates and travel speed
- Enhanced silicon island management
- H4 diffusible hydrogen level
- Tolerates high amounts of surface contaminants
- Superior arc wetting and bead appearance

## WELDING POSITIONS

Flat & Horizontal

## SHIELDING GAS

75-95% Argon / Balance CO<sub>2</sub>  
Flow Rate: 40-60 CFH

## CONFORMANCES

- AWS A5:** E70C-6M-H4, E70T15-M20A4-CS1-H4, E70T15-M21A4-CS1-H4
- ABS:** E110C-K4 H4
- CWB/CSA:** E492C-6MJ-H4
- DNV:** IV Y40MS H5
- AWS D1.8:** 0.045", 0.052", 1/16"
- ISO:** T49 4 T15-0 M A H5

## TYPICAL APPLICATIONS

- Robotics/hard automation
- Structural fabrication
- Process piping and pressure vessels
- Shipbuilding
- Heavy fabrication

## DIAMETERS / PACKAGING

Diameter in (mm)	33 lb (15 kg) Steel Spool	50 lb (22.7 kg) Fiber Spool	50 lb (22.7 kg) Coil	500 lb (227 kg) Accu-Trak® Drum
0.045 (1.1)	ED031583	ED031586	ED031589	ED031592
0.052 (1.3)	ED031584	ED031587	ED031590	ED031593
1/16 (1.6)	ED031585	ED031588	ED031591	ED031594

## MECHANICAL PROPERTIES<sup>(1)</sup> – As Required per AWS A5.18/A5.36

	Yield Strength <sup>(2)</sup> MPa (ksi)	Tensile Strength MPa (ksi)	Elongation %	Charpy V-Notch J (ft·lbf)	
				@ -29°C (-20°F)	@ -40°C (-40°F)
Requirements - AWS A5.18: E70C-6M-H4 AWS A5.36: E70T15-M20A4-CS1-H4	400 (58) min	480 (70) min 490-660 (70-95)	22 min	27 (20) min Not Specified	Not Specified 27 (20) min
Typical Results <sup>(3)</sup>					
As-Welded with 75% Argon / 25% CO <sub>2</sub> <sup>(4)</sup>	450-510 (65-75)	510-590 (75-85)	24-28	96-137 (71-101)	81-111 (60-82)
As-Welded with 90% Argon / 10% CO <sub>2</sub>	480-550 (70-80)	550-620 (80-90)	24-28	57-108 (42-80)	41-94 (30-69)

<sup>(1)</sup>Typical all weld metal. <sup>(2)</sup>Measured with 0.2% offset. <sup>(3)</sup>See test results disclaimer <sup>(4)</sup>Required gas mixture 75-80% Argon/Balance CO<sub>2</sub> for AWS testing.

**DEPOSIT COMPOSITION<sup>(1)</sup> – As Required per AWS A5.18/A5.36**

	%C	%Mn	%Si	%S	%P	%Cu	%Ni
Requirements - AWS A5.18: E70C-6M-H4 AWS A5.36: E70T15-M20A4-CS1-H4	0.12 max	1.75 max	0.90 max	0.03 max 0.030 max	0.03 max 0.030 max	0.50 max 0.035 max	0.50 max
Typical Results <sup>(3)</sup> As-Welded with 75% Argon / 25% CO <sub>2</sub> <sup>(4)</sup> As-Welded with 90% Argon / 10% CO <sub>2</sub>	0.03-0.05 0.03-0.05	1.25-1.60 1.25-1.70	0.50-0.80 0.60-0.85	0.02-0.03 0.02-0.03	0.01-0.02 0.01-0.02	0.01-0.05 0.01-0.05	0.01-0.03 0.01-0.03
	%Cr	%Mo	%V	%B	%Ni + %Cr + %Mo + %V	Diffusible Hydrogen (mL/100g weld deposit)	
Requirements - AWS A5.18: E70C-6M-H4 AWS A5.36: E70T15-M20A4-CS1-H4	0.20 max	0.30 max	0.08 max	Not Specified	0.50 max	4.0 max 4 max	
Typical Results <sup>(3)</sup> As-Welded with 75% Argon / 25% CO <sub>2</sub> <sup>(3)</sup> As-Welded with 90% Argon / 10% CO <sub>2</sub>	0.01-0.04 0.01-0.05	0.01-0.02 0.01-0.02	0.01-0.02 0.01-0.02	0.005-0.006 0.005-0.006	0.05-0.10 0.05-0.10	2-4	

**TYPICAL OPERATING PROCEDURES**

Diameter, Polarity Shielding Gas	CTWD <sup>(5)</sup> mm (in)	Wire Feed Speed m/min (in/min)	Voltage <sup>(6)</sup> (volts)	Approx. Current (amps)	Melt-Off Rate kg/hr (lb/hr)	Deposition Rate kg/hr (lb/hr)	Efficiency (%)
0.045 in (1.1 mm), DC+ 90% Argon / 10% CO <sub>2</sub>	19-25 (3/4-1)	5.1 (200)	21-23	155	2.3 (5.0)	2.1 ((4.6)	92
		6.4 (250)	22-24	185	2.8 (6.2)	2.6 (5.8)	94
		7.6 (300)	22-26	220	3.5 (7.7)	3.2 (7.0)	91
		8.9 (350)	22-27	245	4.0 (8.9)	3.7 (8.2)	93
		10.2 (400)	23-27	260	4.6 (10.1)	4.3 (9.4)	93
		11.4 (450)	23-28	280	5.2 (11.4)	4.9 (10.7)	94
		12.7 (500)	23-29	305	5.7 (12.6)	5.5 (12.2)	97
		14.0 (550)	24-29	315	6.3 (13.9)	6.2 (13.6)	98
		15.2 (600)	25-30	325	6.8 (15.1)	6.7 (14.8)	98
0.052 in (1.3 mm), DC+ 90% Argon / 10% CO <sub>2</sub>	19-25 (3/4-1)	5.1 (200)	22-24	210	3.0 (6.7)	2.9 (6.3)	94
		6.4 (250)	22-26	260	3.9 (8.5)	3.5 (7.8)	92
		7.6 (300)	22-27	290	4.6 (10.2)	4.3 (9.5)	94
		8.9 (350)	23-27	315	5.4 (11.8)	5.2 (11.4)	97
		10.2 (400)	24-28	350	6.3 (13.8)	6.1 (13.4)	97
		11.4 (450)	25-28	370	6.9 (15.2)	6.8 (15.1)	99
		12.7 (500)	27-29	390	7.7 (16.9)	7.6 (16.8)	99
		14.0 (550)	27-30	420	8.4 (18.5)	8.3 (18.3)	99
1/16 in (1.6 mm), DC+ 90% Argon / 10% CO <sub>2</sub>	25-32 (1-1 1/4)	3.8 (150)	22-24	230	3.2 (7.0)	2.8 (6.2)	89
		5.1 (200)	22-25	280	4.3 (9.4)	3.9 (8.7)	93
		6.4 (250)	23-28	310	5.3 (11.6)	5.0 (11.0)	94
		7.6 (300)	24-29	370	6.3 (13.9)	6.3 (13.8)	99
		8.9 (350)	26-30	400	7.4 (16.3)	7.2 (15.9)	98
		10.2 (400)	26-31	450	8.3 (18.4)	8.3 (18.4)	99
11.4 (450)	27-31	480	9.5 (21.0)	9.3 (20.6)	98		

<sup>(1)</sup>Typical all weld metal. <sup>(2)</sup>Measured with 0.2% offset. <sup>(3)</sup>See test results disclaimer <sup>(4)</sup>Required gas mixture 75-80% Argon/Balance CO<sub>2</sub> for AWS testing. <sup>(5)</sup>To estimate ESO, subtract 3/16 in (4.8 mm) from CTWD. <sup>(6)</sup>For greater percentage of CO<sub>2</sub> shielding gas, increase voltage by 1-2 volts. NOTE: This product contains micro-alloying elements. Additional information available upon request.

# METALSHIELD® MC®-706 BUY AMERICA



Mild Steel ▪ AWS E70C-6M H4

## KEY FEATURES

- High deposition rates and travel speed
- Enhanced silicon island management
- H4 diffusible hydrogen level
- Tolerates high amounts of surface contaminants
- Superior arc wetting and bead appearance
- Made in the U.S.A. using steel melted and manufactured in the U.S.A.
- Meets the Buy America requirements of the American Recovery and Reinvestment Act (ARRA)

## WELDING POSITIONS

Flat & Horizontal

## CONFORMANCES

**AWS A5:** E70C-6M-H4, E70T15-M20A4-CS1-H4, E70T15-M21A4-CS1-H4

## TYPICAL APPLICATIONS

- Robotics/Hard automation
- Structural fabrication
- Process piping and pressure vessels
- Shipbuilding
- Heavy fabrication

## SHIELDING GAS

75-95% Argon / Balance CO<sub>2</sub>  
Flow Rate: 40-60 CFH

## DIAMETERS / PACKAGING

Diameter in (mm)	33 lb (15 kg) Steel Spool	500 lb (227 kg) Accu-Trak® Drum
0.045 (1.1)	ED036357	ED036582
0.052 (1.3)	ED036358	ED036583
1/16 (1.6)	ED036359	ED036584

## MECHANICAL PROPERTIES<sup>(1)</sup> – As Required per AWS A5.18/A5.36

	Yield Strength <sup>(2)</sup> MPa (ksi)	Tensile Strength MPa (ksi)	Elongation %	Charpy V-Notch J (ft·lbf)	
				@ -29°C (-20°F)	@ -40°C (-40°F)
Requirements - AWS A5.28: E120C-K4-H4 AWS A5.36: E120T15-M20A6-K4-H4	750 (108) min 740 (108) min	480 (70) min 490-660 (70-95)	22 min	27 (20) min Not Specified	Not Specified 27 (20) min
Typical Results <sup>(3)</sup>					
As-Welded with 75% Argon / 25% CO <sub>2</sub> <sup>(4)</sup>	450-510 (65-75)	510-590 (75-85)	24-28	96-137 (71-101)	81-111 (60-82)
As-Welded with 90% Argon / 10% CO <sub>2</sub>	480-550 (70-80)	550-620 (80-90)	24-28	57-108 (42-80)	41-94 (30-69)

<sup>(1)</sup>Typical all weld metal. <sup>(2)</sup>Measured with 0.2% offset. <sup>(3)</sup>See test results disclaimer <sup>(4)</sup>Required gas mixture 75-80% Argon/Balance CO<sub>2</sub> for AWS testing.

**DEPOSIT COMPOSITION<sup>(1)</sup> – As Required per AWS A5.18/A5.36**

	%C	%Mn	%Si	%S	%P	%Cu	%Ni
Requirements - AWS A5.18: E70C-6M-H4 AWS A5.36: E70T15-M20A4-CS1-H4	0.12 max	1.75 max	0.90 max	0.03 max 0.030 max	0.03 max 0.030 max	0.50 max 0.035 max	0.50 max
Typical Results <sup>(3)</sup>							
As-Welded with 75% Argon / 25% CO <sub>2</sub> <sup>(4)</sup>	0.03-0.05	1.25-1.60	0.50-0.80	0.02-0.03	0.01-0.02	0.01-0.05	0.01-0.03
As-Welded with 90% Argon / 10% CO <sub>2</sub>	0.03-0.05	1.25-1.70	0.60-0.85	0.02-0.03	0.01-0.02	0.01-0.05	0.01-0.03
	%Cr	%Mo	%V	%B	%Ni + %Cr + %Mo + %V	Diffusible Hydrogen (mL/100g weld deposit)	
Requirements - AWS A5.18: E70C-6M-H4 AWS A5.36: E70T15-M20A4-CS1-H4	0.20 max	0.30 max	0.08 max	Not Specified	0.50 max	4.0 max 4 max	
Typical Results <sup>(3)</sup>						2-4	
As-Welded with 75% Argon / 25% CO <sub>2</sub> <sup>(4)</sup>	0.01-0.04	0.01-0.02	0.01-0.02	0.005-0.006	0.05-0.10	2-4	
As-Welded with 90% Argon / 10% CO <sub>2</sub>	0.01-0.05	0.01-0.02	0.01-0.02	0.005-0.006	0.05-0.10	2-4	

**TYPICAL OPERATING PROCEDURES**

Diameter, Polarity Shielding Gas	CTWD <sup>(5)</sup> mm (in)	Wire Feed Speed m/min (in/min)	Voltage <sup>(6)</sup> (volts)	Approx. Current (amps)	Melt-Off Rate kg/hr (lb/hr)	Deposition Rate kg/hr (lb/hr)	Efficiency (%)
0.045 in (1.1 mm), DC+ 90% Argon / 10% CO <sub>2</sub>	19-25 (3/4-1)	5.1 (200)	21-23	155	2.3 (5.0)	2.1 ((4.6)	92
		6.4 (250)	22-24	185	2.8 (6.2)	2.6 (5.8)	94
		7.6 (300)	22-26	220	3.5 (7.7)	3.2 (7.0)	91
		8.9 (350)	22-27	245	4.0 (8.9)	3.7 (8.2)	93
		10.2 (400)	23-27	260	4.6 (10.1)	4.3 (9.4)	93
		11.4 (450)	23-28	280	5.2 (11.4)	4.9 (10.7)	94
		12.7 (500)	23-29	305	5.7 (12.6)	5.5 (12.2)	97
		14.0 (550)	24-29	315	6.3 (13.9)	6.2 (13.6)	98
		15.2 (600)	25-30	325	6.8 (15.1)	6.7 (14.8)	98
0.052 in (1.3 mm), DC+ 90% Argon / 10% CO <sub>2</sub>	19-25 (3/4-1)	16.5 (650)	26-30	355	7.5 (16.5)	7.4 (16.3)	98
		17.8 (700)	26-30	360	8.0 (17.7)	7.9 (17.5)	99
		5.1 (200)	22-24	210	3.0 (6.7)	2.9 (6.3)	94
		6.4 (250)	22-26	260	3.9 (8.5)	3.5 (7.8)	92
		7.6 (300)	22-27	290	4.6 (10.2)	4.3 (9.5)	94
		8.9 (350)	23-27	315	5.4 (11.8)	5.2 (11.4)	97
		10.2 (400)	24-28	350	6.3 (13.8)	6.1 (13.4)	97
11.4 (450)	25-28	370	6.9 (15.2)	6.8 (15.1)	99		
12.7 (500)	27-29	390	7.7 (16.9)	7.6 (16.8)	99		
14.0 (550)	27-30	420	8.4 (18.5)	8.3 (18.3)	99		
1/16 in (1.6 mm), DC+ 90% Argon / 10% CO <sub>2</sub>	25-32 (1-1 1/4)	3.8 (150)	22-24	230	3.2 (7.0)	2.8 (6.2)	89
		5.1 (200)	22-25	280	4.3 (9.4)	3.9 (8.7)	93
		6.4 (250)	23-28	310	5.3 (11.6)	5.0 (11.0)	94
		7.6 (300)	24-29	370	6.3 (13.9)	6.3 (13.8)	99
		8.9 (350)	26-30	400	7.4 (16.3)	7.2 (15.9)	98
		10.2 (400)	26-31	450	8.3 (18.4)	8.3 (18.4)	99
11.4 (450)	27-31	480	9.5 (21.0)	9.3 (20.6)	98		

<sup>(1)</sup>Typical all weld metal. <sup>(2)</sup>Measured with 0.2% offset. <sup>(3)</sup>See test results disclaimer <sup>(4)</sup>Required gas mixture 75-80% Argon/Balance CO<sub>2</sub> for AWS testing. <sup>(5)</sup>To estimate ESO, subtract 3/16 in (4.8 mm) from CTWD. <sup>(6)</sup>For greater percentage of CO<sub>2</sub> shielding gas, increase voltage by 1-2 volts. NOTE: This product contains micro-alloying elements. Additional information available upon request.



# METALSHIELD® MC-710XL®

Mild Steel ▪ AWS E70C-6M H8

## KEY FEATURES

- High column strength for excellent feedability
- Tolerates moderate amounts of surface contaminants

## WELDING POSITIONS

All

## SHIELDING GAS

75-95% Argon / Balance CO<sub>2</sub>  
Flow Rate: 40-60 CFH

## CONFORMANCES

**AWS A5:** E70C-6M-H8, E70C-G-H8,  
E70T15-M20A2-CS1-H8,  
E70T15-M21A2-CS1-H8

**CWB/CSA:** E491C-6M-H8, E491T15-M20A3-CS1-H8,  
E491T15-M21A3-CS1-H8

## TYPICAL APPLICATIONS

- Automotive
- Structural fabrication
- General fabrication
- Applications where long conduit lengths or critical feeding is necessary

## DIAMETERS / PACKAGING

Diameter in (mm)	33 lb (15 kg) Steel Spool	60 lb (27.2 kg) Coil	600 lb (272 kg) Accu-Trak® Drum
0.045 (1.1)	ED030592	ED028526	ED028450
0.052 (1.3)		ED028527	
1/16 (1.6)		ED028528	

## MECHANICAL PROPERTIES<sup>(1)</sup> – As Required per AWS A5.18/A5.36

	Yield Strength <sup>(2)</sup> MPa (ksi)	Tensile Strength MPa (ksi)	Elongation %	Charpy V-Notch J (ft•lbf) @ -29°C (-20°F)
Requirements - AWS A5.18: E70C-6M-H8 AWS A5.36: E70T15-M20A2-CS1-H8	400 (58) min	480 (70) min 490-660 (70-95)	22 min	27 (20) min
Typical Results <sup>(3)</sup>				
As-Welded with 75% Argon / 25% CO <sub>2</sub> <sup>(4)</sup>	450-510 (65-75)	510-590 (75-85)	24-28	54-149 (40-110)
As-Welded with with 90% Argon / 10% CO <sub>2</sub>	480-550 (70-80)	550-620 (80-90)	24-28	54-149 (40-110)

<sup>(1)</sup>Typical all weld metal. <sup>(2)</sup>Measured with 0.2% offset. <sup>(3)</sup>See test results disclaimer <sup>(4)</sup>Required gas mixture 75-80% Argon/Balance CO<sub>2</sub> for AWS testing.

DEPOSIT COMPOSITION<sup>(1)</sup> – As Required per AWS A5.18/A5.36

	%C	%Mn	%Si	%S
Requirements - AWS A5.18: E70C-6M-H8 AWS A5.36: E70T15-M20A2-CS1-H8	0.12 max	1.75 max	0.90 max	0.03 max 0.030 max
Typical Results <sup>(3)</sup>				
As-Welded with 75% Argon / 25% CO <sub>2</sub> <sup>(4)</sup>	0.02-0.05	1.20-1.65	0.50-0.75	0.01-0.02
As-Welded with 90% Argon / 10% CO <sub>2</sub>	0.02-0.05	1.40-1.85	0.50-0.90	0.01-0.02
	%P	%Cu	%Ni	%Cr
Requirements - AWS A5.18: E70C-6M-H8 AWS A5.36: E70T15-M20A2-CS1-H8	0.03 max 0.030 max	0.50 max 0.035 max	0.50 max	0.20 max
Typical Results <sup>(3)</sup>				
As-Welded with 75% Argon / 25% CO <sub>2</sub> <sup>(4)</sup>	0.01-0.02	0.01-0.05	0.02-0.04	0.01-0.04
As-Welded with 90% Argon / 10% CO <sub>2</sub>	0.01-0.02	0.01-0.05	0.02-0.05	0.01-0.04
	%Mo	%V	%Ni + %C + %Mo + %V	Diffusible Hydrogen (mL/100g weld deposit)
Requirements - AWS A5.18: E70C-6M-H8 AWS A5.36: E70T15-M20A2-CS1-H8	0.30 max	0.08 max	0.50 max	8.0 max 8 max
Typical Results <sup>(3)</sup>				
As-Welded with 75% Argon / 25% CO <sub>2</sub> <sup>(4)</sup>	0.01-0.02	0.01-0.02	0.05-0.10	6-8
As-Welded with 90% Argon / 10% CO <sub>2</sub>	0.01-0.02	0.01-0.02	0.05-0.10	

## TYPICAL OPERATING PROCEDURES

Diameter, Polarity Shielding Gas	CTWD <sup>(5)</sup> mm (in)	Wire Feed Speed m/min (in/min)	Voltage <sup>(6)</sup> (volts)	Approx. Current (amps)	Melt-Off Rate kg/hr (lb/hr)	Deposition Rate kg/hr (lb/hr)	Efficiency (%)
0.045 in (1.1 mm), DC+ 90% Argon / 10% CO <sub>2</sub>	19-25 (3/4-1)	5.1 (200)	24-25	165	2.3 (5.1)	2.2 (4.8)	94
		6.4 (250)	25-26	200	2.9 (6.4)	2.8 (6.1)	95
		8.9 (350)	28-29	230	4.1 (9.0)	3.9 (8.6)	95
		11.4 (450)	30-31	310	5.2 (11.5)	5.0 (11.1)	96
		14.0 (550)	32-33	355	6.4 (14.1)	6.2 (13.7)	97
		16.5 (650)	35-36	385	7.6 (16.7)	7.4 (16.2)	97
0.052 in (1.3 mm), DC+ 90% Argon / 10% CO <sub>2</sub>	25-32 (1-1 1/4)	4.4 (175)	23-25	195	2.7 (6.0)	2.5 (5.5)	92
		6.4 (250)	25-27	260	3.9 (8.6)	3.6 (8.0)	93
		8.9 (350)	28-30	330	5.4 (11.9)	5.1 (11.2)	94
		11.4 (450)	31-33	390	7.0 (15.4)	6.6 (14.5)	94
		14.0 (550)	34-36	430	8.5 (18.8)	8.1 (17.8)	95
1/16 in (1.6 mm), DC+ 90% Argon / 10% CO <sub>2</sub>	25-32 (1-1 1/4)	3.8 (150)	24-26	235	3.1 (6.9)	2.9 (6.5)	94
		6.4 (250)	28-30	330	5.2 (11.4)	4.9 (10.8)	95
		8.9 (350)	33-35	410	7.4 (16.3)	7.0 (15.5)	95
		11.4 (450)	35-37	460	9.4 (20.7)	9.0 (19.8)	96

<sup>(1)</sup>Typical all weld metal. <sup>(2)</sup>Measured with 0.2% offset. <sup>(3)</sup>See test results disclaimer. <sup>(4)</sup>Required gas mixture 75-80% Argon/Balance CO<sub>2</sub> for AWS testing.<sup>(5)</sup>To estimate ESO, subtract 3/16 in (4.8 mm) from CTWD. <sup>(6)</sup>For greater percentage of CO<sub>2</sub> shielding gas, increase voltage by 1-2 volts.

# METALSHIELD® Z®

Mild Steel ▪ AWS E70C-GS

## KEY FEATURES

- Designed to enhance productivity and quality of single pass lap and fillet welds on galvanized and other zinc coated steels (galvannealed)
- Capable of travel speeds exceeding 55 inches per minute with zero external porosity and less than 1% internal porosity
- Developed for optimal performance with Rapid Z® Waveform Control Technology®
- Reduces both external and internal weld metal porosity inherent to welding coated steel
- Ideal for welding thin gauge material
- Minimizes heat input into the weldment, reducing burn-through potential and minimizing HAZ size
- Able to successfully bridge gaps due to poor fit-up
- Use with DCEN polarity or customized waveforms for optimal productivity and quality

## CONFORMANCES

**AWS A5:** E70C-GS  
**ISO:** T3T Z Z M M20 3, T49 Z TG-0 M20 S A-G

## TYPICAL APPLICATIONS

- Automotive
- Coated Steels
- Robotics / Hard Automation
- Single Pass Welds

## SHIELDING GAS

90% Argon / 10% CO<sub>2</sub>  
 Flow rate: 40-50 CFH

## WELDING POSITIONS

Flat & Horizontal

## DIAMETERS / PACKAGING

Diameter in (mm)	33 lb (15 kg) Fiber Spool	500 lb (227 kg) Accu-Trak® Drum
0.035 (0.9)	ED036258	ED036259
0.040 (1.0)	ED035515	ED035516

## MECHANICAL PROPERTIES – As Required per AWS A5.18

	Transverse Tensile Strength MPa (ksi)	Longitudinal Bend Test
Requirements - AWS A5.18: E70C-GS	480 (70) min	180° over 3/4 in Radius
Typical Results <sup>(1)</sup> As-Welded with 90% Argon / 10% CO <sub>2</sub>	570 (83)	No openings exceeding 1/8 in

<sup>(1)</sup>Typical all weld metal. <sup>(2)</sup>See test results disclaimer.

DEPOSIT COMPOSITION<sup>(1)</sup> – As Required per AWS A5.18

	%C	%Mn	%Si	%S	%P	%B
Requirements - AWS A5.18: E70C-GS	Not Specified					
Typical Results <sup>(2)</sup> As-Welded with 90% Argon / 10% CO <sub>2</sub>	0.07-0.12	1.5-2.1	0.9-1.25	0.02 max	0.015 max	< 0.001

## TYPICAL OPERATING PROCEDURES

Diameter, Polarity Shielding Gas	CTWD <sup>(3)</sup> mm (in)	Wire Feed Speed m/min (in/min)	Voltage (volts)	Approx. Current (amps)	Melt Off Rate kg/hr (lb/hr)	Deposition Rate kg/hr (lb/hr)	Efficiency (%)
0.035 in (0.9 mm), DC- 90% Argon / 10% CO <sub>2</sub>	15-19 (5/8-3/4)	6.4 (250)	21	129	1.7 (3.8)	1.6 (3.6)	95
		10.2 (400)	23	163	2.8 (6.1)	2.8 (6.1)	99
		14.0 (550)	24	191	3.8 (8.3)	3.7 (8.1)	97
0.040 in (1.0 mm), DC- 90% Argon / 10% CO <sub>2</sub>	15-19 (5/8-3/4)	2.5 (100)	19	100	1.0 (2.1)	0.9 (2.0)	95
		10.8 (425)	23	220	3.9 (8.6)	3.8 (8.3)	97
		14.0 (550)	26	265	5.1 (11.2)	5.0 (11.0)	98

<sup>(1)</sup>Typical all weld metal. <sup>(2)</sup>See test results disclaimer. <sup>(3)</sup>To estimate ESO, subtract 3/16 in (4.8 mm) from CTWD.

# METALSHIELD® MC-80 XLS™

Low Alloy ▪ AWS E80C-Ni1-H4, E80T15-M21A5-Ni1-H4

## KEY FEATURES

- Minimal silicon islands for an exceptionally clean weld surface
- Minimal post weld clean up
- Best-in-class edge wetting for excellent bead appearance
- Smooth, stable arc characteristics with low spatter levels
- Tolerates welding over mill scale and rust
- Low H4 diffusible hydrogen levels
- Designed to accommodate applications requiring Nickel content of 1% max

## WELDING POSITIONS

Flat & Horizontal (CV processes)  
Out of Position (Pulse waveforms)

## CONFORMANCES

**AWS A5:** E80C-Ni1-H4, E80T15-M20A5-Ni1-H4,  
E80T15-M21A5-Ni1-H4,  
E80T15-M22A5-Ni1-H4

**CWB/CSA:** E55C-Ni1-H4 (E80C-Ni1-H4)

## TYPICAL APPLICATIONS

- Robotics/Hard Automation
- Weathering Grades of the Appropriate Strength ASTM A588 & A709 Steels
- Structural Fabrication
- Heavy Fabrication
- Meets Requirements for NACE Applications

## SHIELDING GAS

75-95% Argon / Balance CO<sub>2</sub>  
95% Argon / Balance O<sub>2</sub>  
Flow rate: 40-60 CFH

## DIAMETERS / PACKAGING

Diameter in (mm)	33 lb (15 kg) Plastic Spool (Vacuum Sealed Foil Bag)	750 lb (340 kg) Accu-Trak® Drum
0.045 (1.1)	ED037108	ED037284
0.052 (1.3)	ED037109	ED037285
1/16 (1.6)	ED037110	ED037286

## MECHANICAL PROPERTIES<sup>(1)</sup>

	Yield Strength <sup>(2)</sup> MPa (ksi)	Tensile Strength MPa (ksi)	Elongation %	Charpy V-Notch J (ft•lbf) @ -40°C (-40°F)
Requirements <b>AWS A5.28:</b> E80C-Ni1-H4	470 (68) min	550 (80) min	24 min.	27 (20) min
<b>AWS A5.36:</b> E80T15-M20A5-Ni1-H4, E80T15-M21A5-Ni1-H4, E80T15-M22A5-Ni1-H4		550-690 (80-100)	19 min.	
Typical Results <sup>(3)</sup>				
As-Welded with 90% Argon / 10% CO <sub>2</sub>	560-605 (81-88)	640-675 (93-98)	24-26	52-71 (38-52)
As-Welded with 75% Argon / 25% CO <sub>2</sub>	530-580 (77-84)	605-655 (88-95)	24-27	49-71 (36-52)
As-Welded with 95% Argon / 5% O <sub>2</sub>	540-590 (78-86)	630-660 (91-96)	24-26	50-76 (37-56)

<sup>(1)</sup> Typical all weld metal. <sup>(2)</sup> Measured with 0.2% offset. <sup>(3)</sup> See test results disclaimer.

## DEPOSIT COMPOSITION<sup>(1)</sup>

	%C	%Mn	%Si	%S	%P	%Cu
Requirements <b>AWS A5.28:</b> E80C-Ni1-H4	0.12 max.	1.50 max.	0.90 max.	0.030 max.	0.025 max.	0.35 max.
<b>AWS A5.36:</b> E80T15-M20A5-Ni1-H4, E80T15-M21A5-Ni1-H4, E80T15-M22A5-Ni1-H4		1.75 max.	0.80 max.		0.030 max.	Not Specified
Typical Performance <sup>(3)</sup> As-Welded with 90% Argon / 10% CO <sub>2</sub> As-Welded with 75% Argon / 25% CO <sub>2</sub> As-Welded with 95% Argon / 5% O <sub>2</sub>	0.04-0.05 0.03-0.06 0.04-0.05	1.42-1.50 1.30-1.40 1.36-1.43	0.69-0.70 0.61-0.65 0.64-0.69	≤ 0.015	≤ 0.008	0.03-0.05 0.03-0.06 0.03-0.05
	%Ni	%Cr	%Mo	%V	%B	Diffusible Hydrogen (mL/100g weld deposit)
Requirements <b>AWS A5.28:</b> E80C-Ni1-H4	0.80-1.10 max.	Not Specified	0.30 max.	0.03 max.	Not Specified	4.0 max.
<b>AWS A5.36:</b> E80T15-M20A5-Ni1-H4, E80T15-M21A5-Ni1-H4, E80T15-M22A5-Ni1-H4		0.15 max.	0.35 max.	0.05 max.		4 max.
Typical Performance <sup>(3)</sup> As-Welded with 90% Argon / 10% CO <sub>2</sub> As-Welded with 75% Argon / 25% CO <sub>2</sub> As-Welded with 95% Argon / 5% O <sub>2</sub>	0.83-0.92 0.82-0.93 0.84-0.93	≤ 0.04	≤ 0.10	≤ 0.01	0.003-0.004	2-4

## TYPICAL OPERATING PROCEDURES

Diameter, Polarity Shielding Gas	CTWD <sup>(4)</sup> mm (in)	Wire Feed Speed m/min (in/min)	Voltage <sup>(5)</sup> (volts)	Approx. Current (amps)	Melt-Off Rate kg/hr (lb/hr)	Deposition Rate kg/hr (lb/hr)	Efficiency (%)		
0.045 in (1.1 mm), DC+ 90% Argon / 10% CO <sub>2</sub>	16 - 20 (5/8 - 3/4)	5.1 (200)	21-23	155	2.3 (5.0)	2.1 (4.6)	89		
		6.4 (250)	22-25	185	2.8 (6.2)	2.6 (5.8)	93		
		7.6 (300)	22-26	220	3.5 (7.7)	3.2 (7.0)	90		
		8.9 (350)	22-27	245	4.0 (8.9)	3.7 (8.2)	92		
		10.2 (400)	23-27	260	4.6 (10.1)	4.3 (9.4)	94		
	20 - 25 (3/4 - 1)	12.7 (500)	23-28	305	5.7 (12.6)	5.5 (12.2)	96		
		15.2 (600)	25-29	325	6.8 (15.1)	6.7 (14.8)	96		
		0.052 in (1.3 mm), DC+ 90% Argon / 10% CO <sub>2</sub>	25 - 32 (1 - 1 1/4)	3.6 (150)	22-25	150	2.3 (5.1)	2.1 (4.7)	92
				5.1 (200)	23-26	185	3.0 (6.7)	2.8 (6.2)	93
				6.4 (250)	24-28	210	3.8 (8.4)	3.6 (8.0)	95
7.6 (300)	26-29			240	4.5 (9.9)	4.3 (9.5)	96		
10.2 (400)	27-30			300	6.1 (13.4)	5.8 (12.8)	96		
11.4 (450)	27-30			345	6.8 (15.0)	6.7 (14.8)	99		
12.7 (500)	27-31			380	7.5 (16.6)	7.5 (16.4)	99		
14.0 (550)	28-31	390	8.3 (18.2)	8.2 (18.1)	99				
15.2 (600)	29-32	410	9.0 (19.9)	9.0 (19.8)	99				
1/16 in (1.6 mm), DC+ 90% Argon / 10% CO <sub>2</sub>	25 - 32 (1 - 1 1/4)	3.8 (150)	22-25	235	3.4 (7.5)	3.0 (6.7)	89		
		5.1 (200)	23-26	295	4.4 (9.7)	4.2 (9.2)	95		
		6.4 (250)	24-28	350	5.8 (12.7)	5.4 (11.8)	93		
		7.6 (300)	26-29	395	6.9 (15.2)	6.5 (14.3)	94		
		10.2 (400)	27-30	465	9.2 (20.2)	8.8 (19.3)	96		

<sup>(3)</sup> See test results disclaimer. <sup>(4)</sup> To estimate ESO, subtract 1/4 in. (6.0 mm) from CTWD. <sup>(5)</sup> For shielding gas blends of 95-99% Argon / Balance O<sub>2</sub>, decrease voltage by 1-2 volts.

# METALSHIELD® MC®-90

Low Alloy ▪ AWS E90C-K3 H4

## KEY FEATURES

- H4 diffusible hydrogen levels
- Low spatter and excellent arc stability
- Deoxidizing agents minimize pre- and post-weld clean up
- Enhanced silicon island management
- Low temperature impact properties – Charpy V-Notch test results capable of exceeding 40 J (30 ft•lbf) @ -51°C (-60°F)
- Excellent bead shape and profile

## WELDING POSITIONS

All

## SHIELDING GAS

75-90% Argon / Balance CO<sub>2</sub>  
Flow Rate: 40-60 CFH

## CONFORMANCES

- AWS A5:** E90C-K3-H4, E90T15-M20A6-K3-H4, E90T15-M21A6-K3-H4
- CWB/CSA:** E90C-K3 H4
- ISO:** T62 6 T15-0 M A-N3M2 H5

## TYPICAL APPLICATIONS

- Robotics/hard automation
- HSLA steels (i.e. ASTM A678 & A710)
- Crane fabrication
- Structural fabrication
- Heavy fabrication
- Power generation

## DIAMETERS / PACKAGING

Diameter in (mm)	33 lb (15 kg) Plastic Spool	500 lb (227 kg) Accu-Trak® Drum
0.045 (1.1)	ED033904	ED033907
0.052 (1.3)	ED033905	ED033908
1/16 (1.6)	ED033906	ED033909

## MECHANICAL PROPERTIES<sup>(1)</sup> – As Required per AWS A5.28/A5.36

	Yield Strength <sup>(2)</sup> MPa (ksi)	Tensile Strength MPa (ksi)	Elongation %	Charpy V-Notch J (ft•lbf)	
				@ -40°C (-40°F)	@ -51°C (-60°F)
Requirements - AWS A5.28: E90C-K3-H4 AWS A5.36: E90T15-M20A6-K3-H4	540 (78) min	620 (90) min 620-760 (90-110)	18 min 17 min	Not Specified	27 (20) min
Typical Results <sup>(3)</sup>					
As-Welded with 75% Argon / 25% CO <sub>2</sub>	585-685 (85-100)	655-755 (95-105)	19-27	60-93 (44-68)	36-87 (27-64)
As-Welded with 90% Argon / 10% CO <sub>2</sub>	585-725 (85-105)	655-825 (95-120)	18-25	41-100 (30-74)	27-91 (20-67)

<sup>(1)</sup> Typical all weld metal. <sup>(2)</sup> Measured with 0.2% offset. <sup>(3)</sup> See test results disclaimer

**DEPOSIT COMPOSITION<sup>(1)</sup> – As Required per AWS A5.28/A5.36**

	%C	%Mn	%Si	%S	%P	%Cu
Requirements - AWS A5.28: E90C-K3-H4 AWS A5.36: E90T15-M20A6-K3-H4	0.15 max	0.75-2.25	0.80 max	0.025 max 0.030 max	0.025 max 0.030 max	0.35 max Not Specified
Typical Results <sup>(3)</sup>						
As-Welded with 75% Argon / 25% CO <sub>2</sub>	0.04-0.08	1.00-1.51	0.20-0.35	0.01-0.02	0.01-0.02	0.02-0.06
As-Welded with 90% Argon / 10% CO <sub>2</sub>	0.04-0.08	1.10-1.65	0.20-0.35	0.01-0.02	0.01-0.02	0.03-0.07
	%Ni	%Cr	%Mo	%V	%B	Diffusible Hydrogen (mL/100g weld deposit)
Requirements - AWS A5.28: E90C-K3-H4 AWS A5.36: E90T15-M20A6-K3-H4	0.50-2.50 1.25 - 2.60	0.15 max	0.25-0.65	0.03 max 0.05 max	Not Specified	4.0 max 4 max
Typical Results <sup>(3)</sup>						
As-Welded with 75% Argon / 25% CO <sub>2</sub>	1.50-1.90	0.01-0.10	0.30-0.45	0.01-0.02	0.003-0.004	2.5-4
As-Welded with 90% Argon / 10% CO <sub>2</sub>	1.60-1.90	0.01-0.10	0.30-0.45	0.01-0.02	0.003-0.004	

**TYPICAL OPERATING PROCEDURES**

Diameter, Polarity Shielding Gas <sup>(4)</sup>	CTWD <sup>(5)</sup> mm (in)	Wire Feed Speed		Voltage (volts)	Approx. Current (amps)	Melt-Off Rate		Deposition Rate		Efficiency (%)
		m/min	(in/min)			kg/hr	(lb/hr)	kg/hr	(lb/hr)	
0.045 in (1.1 mm), DC+ 90% Argon / 10% CO <sub>2</sub>	19-25 (3/4-1)	5.1	(200)	21-23	170	2.4	(5.3)	2.2	(4.7)	89
		6.4	(250)	23-25	195	3.0	(6.7)	2.7	(6.0)	90
		8.9	(350)	25-27	250	4.3	(9.4)	3.8	(8.4)	89
		11.4	(450)	27-29	285	5.4	(11.9)	5.2	(11.4)	96
		14.0	(550)	29-31	330	6.6	(14.5)	6.4	(14.1)	97
		16.6	(650)	31-33	360	7.8	(17.3)	7.7	(16.9)	98
0.052 in (1.3 mm), DC+ 90% Argon / 10% CO <sub>2</sub>	19 - 25 (3/4-1)	5.1	(200)	22-24	225	3.2	(7.1)	2.9	(6.5)	91
		6.4	(250)	24-26	260	4.0	(8.8)	3.6	(7.9)	90
		8.9	(350)	26-28	295	5.6	(12.4)	5.3	(11.8)	95
		11.4	(450)	28-30	345	7.2	(15.9)	7.1	(15.6)	98
		14.0	(550)	30-32	400	8.7	(19.2)	8.6	(18.9)	98
1/16 in (1.6 mm), DC+ 90% Argon / 10% CO <sub>2</sub>	25-32 (1-1 1/4)	5.1	(200)	23-25	260	4.4	(9.7)	4.0	(8.9)	91
		6.4	(250)	26-28	300	5.5	(12.1)	5.2	(11.4)	94
		8.9	(350)	28-30	360	7.7	(16.9)	7.5	(16.5)	98
		11.4	(450)	30-32	420	9.9	(21.8)	9.7	(21.3)	98

<sup>(1)</sup> Typical all weld metal. <sup>(2)</sup> Measured with 0.2% offset. <sup>(3)</sup> See test results disclaimer. <sup>(4)</sup> For greater percentage of CO<sub>2</sub> shielding gas, increase voltage by 1-2 volts. <sup>(5)</sup> To estimate ESO, subtract 3/16 in. (4.8 mm) from CTWD. NOTE: Consult steel manufacturer's recommendations regarding minimum and maximum pre-heat temperature, interpass temperature, and heat input.



# METALSHIELD® MC®-110

Low Alloy ▪ AWS E110C-K4 H4

## KEY FEATURES

- H4 diffusible hydrogen levels
- Low spatter and excellent arc stability
- Deoxidizing agents minimize pre- and post-weld clean up
- Enhanced silicon island management
- Low temperature impact properties – Charpy V-Notch test results capable of exceeding 40 J (30 ft•lbf) @ -51°C (-60°F)
- Excellent bead shape and profile

## WELDING POSITIONS

All

## SHIELDING GAS

75-90% Argon / Balance CO<sub>2</sub>  
Flow Rate: 40-60 CFH

## CONFORMANCES

- AWS A5:** E110C-K4-H4, E110T15-M20A6-K4-H4, E110T15-M21A6-K4-H4
- CWB/CSA:** E110C-K4 H4
- ISO:** T76 6 T15-0 M A-N4C1M2 H5

## TYPICAL APPLICATIONS

- Robotics/hard automation
- HSLA and quenched and tempered steels (i.e. HY-100 and ASTM 514)
- Crane fabrication
- Heavy Equipment
- Pressure vessels

## DIAMETERS / PACKAGING

Diameter in (mm)	33 lb (15 kg) Plastic Spool	500 lb (227 kg) Accu-Trak® Drum
0.045 (1.1)	ED033910	ED033913
0.052 (1.3)	ED033911	ED033914
1/16 (1.6)	ED033912	ED033915

## MECHANICAL PROPERTIES<sup>(1)</sup> – As Required per AWS A5.28/A5.36

	Yield Strength <sup>(2)</sup> MPa (ksi)	Tensile Strength MPa (ksi)	Elongation %	Charpy V-Notch J (ft•lbf)	
				@ -40°C (-40°F)	@ -51°C (-60°F)
Requirements - AWS A5.28: E110C-K4-H4 AWS A5.36: E110T15-M20A6-K4-H4	680 (98) min	760 (110) min 760-900 (110-130)	15 min	Not Specified	27 (20) min
Typical Results <sup>(3)</sup>					
As-Welded with 75% Argon / 25% CO <sub>2</sub>	690-795 (100-115)	760-825 (110-120)	20-24	60-88 (44-65)	45-80 (34-59)
As-Welded with 90% Argon / 10% CO <sub>2</sub>	725-825 (105-120)	790-895 (115-130)	18-23	66-95 (48-70)	59-82 (44-61)

<sup>(1)</sup> Typical all weld metal. <sup>(2)</sup> Measured with 0.2% offset. <sup>(3)</sup> See test results disclaimer

**DEPOSIT COMPOSITION<sup>(1)</sup> – As Required per AWS A5.28/A5.36**

	%C	%Mn	%Si	%S	%P	%Cu
Requirements - AWS A5.28: E110C-K4-H4 AWS A5.36: E110T15-M20A6-K4-H4	0.15 max	0.75-2.25 1.20 - 2.25	0.80 max	0.025 max 0.030 max	0.025 max 0.030 max	0.35 max Not Specified
Typical Results <sup>(3)</sup>						
As-Welded with 75% Argon / 25% CO <sub>2</sub>	0.05-0.08	1.45-1.75	0.45-0.65	0.01-0.02	0.01-0.02	0.02-0.06
As-Welded with 90% Argon / 10% CO <sub>2</sub>	0.05-0.08	1.45-1.75	0.45-0.65	0.01-0.02	0.01-0.02	0.02-0.06
	%Ni	%Cr	%Mo	%V	Diffusible Hydrogen (mL/100g weld deposit)	
Requirements - AWS A5.28: E110C-K4-H4 AWS A5.36: E110T15-M20A6-K4-H4	0.50-2.50 1.75 - 2.60	0.15-0.65 0.20 - 0.60	0.25-0.65 0.20 - 0.65	0.03 max	4.0 max 4 max	
Typical Results <sup>(3)</sup>						
As-Welded with 75% Argon / 25% CO <sub>2</sub>	2.00-2.20	0.20-0.35	0.45-0.55	0.01-0.02	2.5-4	
As-Welded with 90% Argon / 10% CO <sub>2</sub>	2.00-2.20	0.20-0.35	0.45-0.55	0.01-0.02		

**TYPICAL OPERATING PROCEDURES**

Diameter, Polarity Shielding Gas <sup>(4)</sup>	CTWD <sup>(5)</sup> mm (in)	Wire Feed Speed m/min (in/min)	Voltage (volts)	Approx. Current (amps)	Melt-Off Rate kg/hr (lb/hr)	Deposition Rate kg/hr (lb/hr)	Efficiency (%)
0.045 in (1.1 mm), DC+ 90% Argon / 10% CO <sub>2</sub>	19-25 (3/4-1)	5.1 (200)	22-24	170	2.4 (5.3)	2.1 (4.7)	88
		6.4 (250)	24-26	190	3.0 (6.7)	2.8 (6.1)	91
		8.9 (350)	26-28	240	4.2 (9.2)	3.8 (8.4)	91
		11.4 (450)	28-30	290	5.4 (11.8)	5.1 (11.3)	95
		14.0 (550)	30-32	330	6.5 (14.4)	6.3 (13.9)	97
		16.6 (650)	31-33	370	7.8 (17.1)	7.6 (16.7)	97
0.052 in (1.3 mm), DC+ 90% Argon / 10% CO <sub>2</sub>	19-25 (3/4-1)	5.1 (200)	23-25	225	3.2 (7.0)	2.8 (6.2)	89
		6.4 (250)	25-27	255	4.0 (8.8)	3.7 (8.1)	92
		8.9 (350)	27-29	295	5.5 (12.2)	5.3 (11.6)	95
		11.4 (450)	29-31	350	7.2 (15.8)	7.0 (15.4)	98
		14.0 (550)	31-33	400	8.7 (19.1)	8.5 (18.8)	98
1/16 in (1.6 mm), DC+ 90% Argon / 10% CO <sub>2</sub>	25-32 (1-1 1/4)	5.1 (200)	24-26	270	4.4 (9.6)	3.9 (8.6)	89
		6.4 (250)	26-28	320	5.4 (12.1)	5.1 (11.3)	94
		8.9 (350)	28-30	385	7.7 (16.9)	7.4 (16.4)	97
		11.4 (450)	30-32	465	9.8 (21.6)	9.6 (21.2)	98

<sup>(1)</sup> Typical all weld metal. <sup>(2)</sup> Measured with 0.2% offset. <sup>(3)</sup> See test results disclaimer. <sup>(4)</sup> For greater percentage of CO<sub>2</sub> shielding gas, increase voltage by 1-2 volts. <sup>(5)</sup> To estimate ESO, subtract 3/16 in. (4.8 mm) from CTWD. NOTE: Consult steel manufacturer's recommendations regarding minimum and maximum pre-heat temperature, interpass temperature, and heat input.

# METALSHIELD® MC®-120

Low Alloy ▪ AWS E120C-K4-H4, E120T15-M20A6-K4-H4

## KEY FEATURES

- H4 diffusible hydrogen levels
- Low spatter and excellent arc stability
- Deoxidizing agents minimize pre- and post-weld clean up
- Enhanced silicon island management
- Low temperature impact properties – Charpy V-Notch test results capable of exceeding 27 J (20 ft•lbf) @ -51°C (-60°F)
- Excellent bead shape and profile

## WELDING POSITIONS

All

## SHIELDING GAS

75-90% Argon / Balance CO<sub>2</sub>  
Flow Rate: 40-60 CFH

## CONFORMANCES

**AWS A5:** E120C-K4-H4, E120T15-M20A6-K4-H4  
**CWB/CSA:** E83C-K4-H4

## TYPICAL APPLICATIONS

- Robotics/hard automation
- HSLA and quenched and tempered steels (i.e. HY-100 and ASTM A514)
- Crane fabrication
- Heavy Equipment
- Pressure vessels

## DIAMETERS / PACKAGING

Diameter in (mm)	33 lb (15 kg) Plastic Spool
0.052 (1.3)	ED036480

## MECHANICAL PROPERTIES<sup>(1)</sup>

	Yield Strength <sup>(2)</sup> MPa (ksi)	Tensile Strength MPa (ksi)	Elongation %	Charpy V-Notch J (ft•lbf)	
				@ -40°C (-40°F)	@ -51°C (-60°F)
Requirements - AWS A5.28: E120C-K4-H4 AWS A5.36: E120T15-M20A6-K4-H4	750 (108) min 740 (108) min	830 (120) min 830-970 (120-140)	15 min 14 min	Not Specified	27 (20) min
Typical Results <sup>(3)</sup>					
As-Welded with 75% Argon / 25% CO <sub>2</sub>	790-800 (115-116)	855-860 (124-125)	22	60-70 (45-52)	40-45 (31-34)
As-Welded with 90% Argon / 10% CO <sub>2</sub>	820-860 (119-125)	880-915 (128-133)	21	50-70 (39-55)	45-46 (32-34)

<sup>(1)</sup> Typical all weld metal. <sup>(2)</sup> Measured with 0.2% offset. <sup>(3)</sup> See test results disclaimer

**DEPOSIT COMPOSITION<sup>(1)</sup>**

	%C	%Mn	%Si	%S	%P	%Cu
Requirements - AWS A5.28: E120C-K4-H4 AWS A5.36: E120T15-M20A6-K4-H4	0.15 max	0.75-2.25 1.20 - 2.25	0.80 max	0.025 max 0.030 max	0.025 max 0.030 max	0.35 max Not Specified
Typical Results <sup>(3)</sup>						
As-Welded with 75% Argon / 25% CO <sub>2</sub>	0.06 - 0.07	1.70 - 1.80	0.58 - 0.62	0.010	0.010	0.02
As-Welded with 90% Argon / 10% CO <sub>2</sub>	0.06 - 0.08	1.80 - 1.90	0.60 - 0.66	0.020		0.02 - 0.03
	%Ni	%Cr	%Mo	%V	Diffusible Hydrogen (mL/100g weld deposit)	
Requirements - AWS A5.28: E120C-K4-H4 AWS A5.36: E120T15-M20A6-K4-H4	0.50-2.50 1.75 - 2.60	0.15-0.65 0.20 - 0.60	0.25-0.65 0.20 - 0.65	0.03 max	4.0 max 4 max	
Typical Results <sup>(3)</sup>						
As-Welded with 75% Argon / 25% CO <sub>2</sub>			0.55 - 0.58	0.01	1.0 - 3.0	
As-Welded with 90% Argon / 10% CO <sub>2</sub>	1.90 - 2.10	0.31 - 0.33	0.56 - 0.63			

**TYPICAL OPERATING PROCEDURES**

Diameter, Polarity Shielding Gas <sup>(4)</sup>	CTWD <sup>(5)</sup> mm (in)	Wire Feed Speed m/min (in/min)	Voltage (volts)	Approx. Current (amps)	Melt-Off Rate kg/hr (lb/hr)	Deposition Rate kg/hr (lb/hr)	Efficiency (%)
0.052 in (1.3 mm), DC+ 90% Argon / 10% CO <sub>2</sub>	19-25 (3/4-1)	5.1 (200)	23-25	200	3.1 (6.8)	2.9 (6.5)	96
		6.4 (250)	25-27	230	3.9 (8.5)	3.7 (8.1)	95
		8.9 (350)	27-29	320	5.8 (12.7)	5.4 (11.8)	93
		11.4 (450)	29-31	370	7.3 (16.1)	7.2 (15.8)	98
		14.0 (550)	31-33	420	9.0 (19.8)	8.7 (19.2)	97

<sup>(1)</sup> Typical all weld metal. <sup>(2)</sup> Measured with 0.2% offset. <sup>(3)</sup> See test results disclaimer. <sup>(4)</sup> For greater percentage of CO<sub>2</sub> shielding gas, increase voltage by 1-2 volts. <sup>(5)</sup> To estimate ESO, subtract 3/16 in. (4.8 mm) from CTWD.



# FLUX-CORED

## *Self-Shielded (FCAW-S) Wire*

### **Mild Steel, Flat and Horizontal**

Innershield® NR®-5 .....	D-1
Innershield® NR®-131 .....	D-2
Innershield® NR®-305 .....	D-3
Innershield® NR®-311 .....	D-4
Innershield® NS-3M .....	D-5

### **Low Alloy, Flat and Horizontal**

Innershield® NR®-311 Ni .....	D-6
-------------------------------	-----

### **Mild Steel, All Positions**

Innershield® NR®-152 .....	D-7
Innershield® NR®-203-MP .....	D-8
Innershield® NR®-211-MP .....	D-9
Innershield® NR®-232 .....	D-11
Innershield® NR®-232-H .....	D-13
Innershield® NR®-233 .....	D-15

### **Low Alloy, All Positions**

Innershield® NR®-203 Nickel (1%) .....	D-17
Innershield® NR®-203 Ni C Plus-H .....	D-18
Innershield® NR®-207 .....	D-19
Innershield® NR®-208-H .....	D-20
Innershield® NR®-212 .....	D-21
Innershield® NR®-440Ni2 .....	D-23
Innershield® NR®-555 .....	D-25

## *Gas-Shielded (FCAW-G) Wire*

### **Mild Steel, All Positions**

UltraCore® 360™ C71 .....	D-27
UltraCore® 360™ M71 .....	D-29
UltraCore® 71A75 Dual .....	D-31
UltraCore® 71A85 .....	D-33
UltraCore® 71C .....	D-35
UltraCore® 712C .....	D-37
UltraCore® 712C-H Plus .....	D-39
UltraCore® 712A80 .....	D-41
UltraCore® 712A80-H .....	D-43
UltraCore® 712A80-H Plus .....	D-45
UltraCore® Clarity™ C71 LE .....	D-47
UltraCore® Clarity™ M71 LE .....	D-49
UltraCore® HD-C .....	D-51
UltraCore® HD-M .....	D-53
UltraCore® HD-12C .....	D-55
UltraCore® HD-12M .....	D-57
UltraCore® HD Marine .....	D-59
Outershield® 71M .....	D-61
Outershield® 71 Elite .....	D-63
Outershield® 71 Supreme .....	D-65

### **Mild Steel, Flat and Horizontal**

UltraCore® 70C .....	D-67
UltraCore® 70M .....	D-69
UltraCore® 75C .....	D-71
UltraCore® XP70 .....	D-73
Outershield® 70 .....	D-75
Outershield® XLH-70 .....	D-77

## FCAW-S & FCAW-G CONSUMABLES

# FLUX-CORED

### Low Alloy, All Positions

UltraCore® 81Ni1A75-H.....	D-79
UltraCore® 81Ni1C-H .....	D-81
UltraCore® 81Ni1C-H Plus.....	D-83
UltraCore® 81Ni1M-H Plus .....	D-85
UltraCore® 81Ni2A75-H.....	D-87
UltraCore® 81Ni2C-H .....	D-89
UltraCore® 81K2A75-H .....	D-91
UltraCore® 81K2C-H.....	D-93
UltraCore® 81K2C-H Plus .....	D-95
UltraCore® 81K2M-H Plus.....	D-97
UltraCore® 91K2C-H Plus .....	D-99
UltraCore® 91K2M-H Plus.....	D-101
UltraCore® 101K3M-H Plus .....	D-103
UltraCore® 111K3C-H Plus .....	D-105
UltraCore® 111K3M-H Plus .....	D-107
UltraCore® 121K3M-H Plus .....	D-109
Cornet® 1 .....	D-111
Cornet® 2 .....	D-112
Cornet® 5 .....	D-113
Supercore® F91.....	D-114

### Low Alloy, Flat and Horizontal

UltraCore® 80Ni1C.....	D-115
UltraCore® 80Ni1M .....	D-117





# INNERSHIELD® NR®-5

Mild Steel, Flat & Horizontal ▪ AWS E70T-3, E70T3S

## KEY FEATURES

- Fast travel speeds
- Increased resistance to porosity
- Consistent bead appearance

## WELDING POSITIONS

Flat & Horizontal

## MAXIMUM PLATE THICKNESS

Diameter - in (mm)	Maximum Plate Thickness - in (mm)
3/32 (2.4)	3/16 (4.8)
0.120 (3.0)	3/16 (4.8)

## DIAMETERS / PACKAGING

Diameter in (mm)	600 lb (272 kg) Speed-Feed® Reel	600 lb (272 kg) Speed-Feed® Drum
3/32 (2.4)	ED012698	ED012699
0.120 (3.0)		

## MECHANICAL PROPERTIES<sup>(1)</sup>

	Transverse Tensile Strength MPa (ksi)	Longitudinal Bend Test	Hardness Rockwell B
<b>Requirements</b> - AWS E70T-3	480 (70) min	180° over 3/4 in Radius No openings exceeding 1/8 in	–
<b>Typical Results<sup>(2)</sup></b>	505-560 (75-80)	Passed	99

## DEPOSIT COMPOSITION<sup>(1)</sup>

	%C	%Mn	%Si	%S	%P	%Al	%Ti
<b>Requirements</b> - AWS E70T-3	Not Specified						
<b>Typical Results<sup>(2)</sup></b>	0.17-0.22	0.95-1.11	0.34-0.40	0.008-0.02	0.01-0.02	0.07-0.12	0.40-0.49

## TYPICAL OPERATING PROCEDURES

Diameter, Polarity	CTWD mm (in)	Wire Feed Speed m/min (in/min)	Voltage (volts)	Approx. Current (amps)	Melt-Off Rate kg/hr (lb/hr)	Deposition Rate kg/hr (lb/hr)	Efficiency (%)
3/32 in (2.4 mm), DC+	32 (1-1/4)	2.5 (100)	22-23	340	4.5 (9.9)	3.5 (7.8)	77
		3.8 (150)	23-24	435	6.7 (14.8)	5.6 (12.3)	83
		5.1 (200)	24-25	510	9.0 (19.8)	7.7 (16.9)	85
		6.4 (250)	25-26	575	11.2 (24.7)	9.7 (21.4)	87
0.120 in (3.0 mm), DC+	32 (1-1/4)	3.3 (130)	22-23	500	8.2 (18.0)	7.6 (16.7)	93
		4.2 (165)	23-24	600	10.4 (23.0)	9.5 (20.9)	91
		6.5 (205)	24-25	700	12.9 (28.5)	11.6 (25.6)	90
		6.5 (255)	25-26	800	16.1 (35.5)	14.3 (31.5)	90

<sup>(1)</sup>Typical all weld metal. <sup>(2)</sup>See test results disclaimer

## CONFORMANCES

AWS A5: E70T-3 E70T3S

## TYPICAL APPLICATIONS

- Single pass welding on up to 48 mm (3/16 in) thicknesses
- 3 o'clock welding positions
- Welds with copper back-up
- Propane cylinders
- Robotics/hard automation

## WARNING

- NR-5 IS NOT RECOMMENDED FOR WELDING MULTIPLE PASSES

# INNERSHIELD® NR®-131

Mild Steel, Flat & Horizontal ▪ AWS E70T-10, E70T10S

## KEY FEATURES

- Fast travel speeds and high deposition rates
- Maximum penetration
- Flat bead profile on butt welds
- Join dissimilar plate thicknesses with even heat distribution

## WELDING POSITIONS

Flat & Horizontal

## CONFORMANCES

AWS A5: E70T-10 E70T10S

## TYPICAL APPLICATIONS

- Single pass welding on up to 2.8 mm (0.110 in) thicknesses
- Sheet metal
- Automotive

## WARNING

- NR-131 IS NOT RECOMMENDED FOR WELDING MULTIPLE PASSES

## DIAMETERS / PACKAGING

Diameter in (mm)	600 lb (272 kg) Speed-Feed® Reel
3/32 (2.4)	ED012163

## MECHANICAL PROPERTIES<sup>(1)</sup>

	Transverse Tensile Strength MPa (ksi)	Longitudinal Bend Test	Hardness Rockwell B
<b>Requirements</b> - AWS E70T-10	480 (70) min	180° over 3/4 in Radius No openings exceeding 1/8 in	–
<b>Typical Results<sup>(2)</sup></b>	505-560 (75-80)	Passed	99

## DEPOSIT COMPOSITION<sup>(1)</sup>

	%C	%Mn	%Si	%S	%P	%Al
<b>Requirements</b> - AWS E70T-10	Not Specified					
<b>Typical Results<sup>(2)</sup></b>	0.22-0.26	0.42-0.65	0.20-0.27	0.005-0.007	0.007-0.02	1.18-1.49

## TYPICAL OPERATING PROCEDURES

Diameter, Polarity	CTWD mm (in)	Wire Feed Speed m/min (in/min)	Voltage (volts)	Approx. Current (amps)	Melt-Off Rate kg/hr (lb/hr)	Deposition Rate kg/hr (lb/hr)	Efficiency (%)
3/32 in (2.4 mm), Single Arc, DC-	38 (1-1/2)	3.8 (150)	25-26	390	6.5 (14.3)	5.3 (11.6)	81
		5.1 (200)	25-27	490	8.6 (19.0)	7.1 (15.6)	82
		6.4 (250)	26-27	570	10.8 (23.7)	8.9 (19.6)	82
		8.9 (350)	26-28	720	15.0 (33.1)	33.6 (27.6)	83
		10.8 (425)	27-28	810	18.2 (40.1)	15.2 (33.6)	83
3/32 in (2.4 mm), Twinarc, DC-	44 (1-3/4)	3.3 (130)	25-26	550	11.1 (24.5)	8.1 (17.9)	72
		4.4 (175)	26-27	740	15.0 (33.0)	12.0 (26.4)	79
		5.7 (225)	26-28	910	19.3 (42.5)	15.8 (34.8)	81
		7.0 (275)	27-29	1030	23.5 (51.9)	19.1 (42.0)	80
		8.3 (325)	28-30	1090	27.9 (61.4)	21.9 (48.2)	78

<sup>(1)</sup>Typical all weld metal. <sup>(2)</sup>See test results disclaimer

# INNERSHIELD® NR®-305

Mild Steel, Flat & Horizontal ■ AWS E70T-6, E70T6-A2-CS3-H16

## KEY FEATURES

- High deposition rates in the flat and horizontal positions
- Smooth arc and low spatter levels
- Capable of producing weld deposits with impact properties exceeding 27 J (20 ft•lbf) at -29°C (-20°F)
- Welds on lightly rusted or primed plate
- Meets AWS D1.8 seismic lot waiver requirements

## WELDING POSITIONS

Flat & Horizontal

## CONFORMANCES

<b>AWS A5:</b>	E70T6-A2-CS3-H8, E70T-6-H8
<b>ABS:</b>	2YSA E70T-6-H16
<b>DNV:</b>	II YMS
<b>AWS D1.8:</b>	5/64", 3/32"
<b>ISO:</b>	T49 3 T8-1 NO A H10

## TYPICAL APPLICATIONS

- General plate fabrication
- Structural fabrication, including those subject to seismic requirements
- Bridges and offshore rigs
- Shipyards, stiffener welding on barges
- Welding over tack welds made with stick electrode

## DIAMETERS / PACKAGING

Diameter in (mm)	25 lb (11.3 kg) Steel Spool	25 lb (11.3 kg) Plastic Spool (Vacuum Sealed Foil Bag)	50 lb (22.7 kg) Coil	50 lb (22.7 kg) 50 lb Coil (Vacuum Sealed Foil Bag)
5/64 (2.0)	ED034185	ED030971	ED012593	ED030005
3/32 (2.4)				

## MECHANICAL PROPERTIES<sup>(1)</sup>

	Yield Strength <sup>(2)</sup> MPa (ksi)	Tensile Strength MPa (ksi)	Elongation %	Hardness Rockwell B	Charpy V-Notch J (ft•lbf) @ -29°C (-20°F)
<b>Requirements</b> - AWS E70T-6	400 (58) min	480-655 (70-95)	22 min	–	27 (20) min
<b>Typical Results<sup>(3)</sup></b> - As-Welded	465-535 (68-77)	565-620 (82-90)	24-28	88-93	27-41 (20-30)

## DEPOSIT COMPOSITION<sup>(1)</sup>

	%C	%Mn	%Si	%S	%P	%Al
<b>Requirements</b> - AWS E70T-6	0.30 max	1.75 max	0.60 max	0.03 max	0.03 max	1.8 max
<b>Typical Results<sup>(3)</sup></b>	0.06-0.09	1.08-1.57	0.20-0.27	≤0.01	≤0.01	0.9-1.1

## TYPICAL OPERATING PROCEDURES

Diameter, Polarity	CTWD mm (in)	Wire Feed Speed m/min (in/min)	Voltage (volts)	Approx. Current (amps)	Melt-Off Rate kg/hr (lb/hr)	Deposition Rate kg/hr (lb/hr)	Efficiency (%)
5/64 in (2.0 mm), DC+	35-51 (1 3/8-2)	4.4 (175)	20-22	300	8.5 (10.5)	4.0 (8.8)	84
		5.6 (220)	21-23	330	6.0 (13.3)	5.0 (11.1)	83
		6.6 (260)	22-24	360	7.1 (15.7)	5.9 (13.1)	83
		7.6 (300)	24-26	375	8.2 (18.1)	6.9 (15.2)	84
		8.3 (325)	25-27	400	8.9 (19.7)	7.4 (16.4)	83
3/32 in (2.4 mm), DC+	41-54 (1 5/8-2 1/4) <sup>(4)</sup>	4.1 (160)	21-23	330	6.0 (13.3)	5.0 (11.0)	82
		6.1 (240)	24-26	425	9.1 (20.0)	7.6 (16.7)	83
		7.6 (300)	27-29	475	11.3 (25.0)	9.5 (21.0)	84
		10.2 (400)	33-35	525	15.2 (33.4)	12.7 (28.0)	83

<sup>(1)</sup>Typical all weld metal. <sup>(2)</sup>Measured with 0.2% offset. <sup>(3)</sup>See test results disclaimer <sup>(4)</sup>Use CTWD of 2 1/4 in (54 mm) for wire feed speeds greater than 300 ipm.  
NOTE: FEMA 353 and AWS D1.8 structural steel seismic supplement test data can be found on this product at [www.lincolnelectric.com](http://www.lincolnelectric.com).

# INNERSHIELD® NR®-311

Mild Steel, Flat & Horizontal ▪ AWS E70T-7, E70T7-AZ-CS3

## KEY FEATURES

- High deposition rates and fast travel speeds
- Easy slag removal
- Optimal toe wash-in
- Deep penetration
- High resistance to cracking
- Welds on lightly rusted or primed plate

## WELDING POSITIONS

Flat & Horizontal

## CONFORMANCES

- AWS A5:** E70T-7 E70T7-AZ-CS3  
**ABS:** E70T-7  
**CWB/CSA:** E490T7-AZ-CS3 E492T-7

## TYPICAL APPLICATIONS

- Recommended for fillet, lap and butt welds on 3.2 mm (1/8 in) and thicker steel, including some low alloy steels
- General fabrication
- Assembly welding

## DIAMETERS / PACKAGING

Diameter in (mm)	14 lb (6.4 kg) Coil 56 lb (25.4 kg) Master Carton	25 lb (11.3 kg) Steel Spool	50 lb (22.7 kg) Coil	600 lb (272 kg) Speed-Feed® Reel	600 lb (272 kg) Speed-Feed® Drum
5/64 (2.0)	ED014464	ED030649	ED014459 ED012629 ED012632	ED012633	ED012628
3/32 (2.4)					
7/64 (2.8)					

## MECHANICAL PROPERTIES<sup>(1)</sup>

	Yield Strength <sup>(2)</sup> MPa (ksi)	Tensile Strength MPa (ksi)	Elongation %	Hardness Rockwell B
<b>Requirements</b> - AWS E70T-7	400 (58) min	480-655 (70-95)	22 min	-
<b>Typical Results<sup>(3)</sup></b> - As-Welded	420-475 (61-69)	600-645 (87-93)	23-26	88-92

## DEPOSIT COMPOSITION<sup>(1)</sup>

	%C	%Mn	%Si	%S	%P	%Al
<b>Requirements</b> - AWS E70T-7	0.30 max	1.75 max	0.60 max	0.03 max	0.03 max	1.8 max
<b>Typical Results<sup>(3)</sup></b>	0.25-0.29	0.44-0.51	0.09-0.12	≤0.01	≤0.01	1.4-1.7

## TYPICAL OPERATING PROCEDURES

Diameter, Polarity	CTWD mm (in)	Wire Feed Speed m/min (in/min)	Voltage (volts)	Approx. Current (amps)	Melt-Off Rate kg/hr (lb/hr)	Deposition Rate kg/hr (lb/hr)	Efficiency (%)
5/64 in (2.0 mm), DC-	38 (1 1/2)	2.5 (100)	20-23	190	2.9 (6.4)	2.3 (5.0)	78
		4.1 (160)	24-28	275	4.7 (10.3)	3.6 (8.0)	78
		6.1 (240)	25-29	355	7.0 (15.4)	5.6 (12.4)	80
		7.6 (300)	27-31	410	8.8 (19.3)	7.2 (15.8)	82
3/32 in (2.4 mm), DC-	45 (1 3/4)	1.9 (75)	20-23	200	3.2 (7.0)	2.5 (5.4)	77
		3.4 (135)	23-26	300	5.9 (13.1)	4.6 (10.2)	78
		3.8 (150)	24-27	325	6.6 (14.6)	5.2 (11.4)	78
		5.3 (210)	26-28	400	9.3 (20.4)	7.5 (16.5)	81
		6.9 (270)	28-30	450	11.9 (26.2)	10.0 (22.0)	84
7/64 in (2.8 mm), DC-	45 (1 3/4)	2.5 (100)	23-26	325	5.4 (12.0)	4.5 (10.0)	83
		3.7 (145)	25-27	400	8.1 (17.8)	6.6 (14.5)	82
		4.4 (175)	26-28	450	9.8 (21.5)	8.2 (18.0)	83
		6.1 (240)	30-32	550	13.4 (29.5)	11.6 (25.5)	86
		7.6 (300)	32-34	625	16.7 (36.9)	15.0 (33.0)	89

<sup>(1)</sup>Typical all weld metal. <sup>(2)</sup>Measured with 0.2% offset. <sup>(3)</sup>See test results disclaimer

# INNERSHIELD® NS-3M

Mild Steel, Flat & Horizontal ▪ AWS E70T-4, E70T4-AZ-CS3

## KEY FEATURES

- Very high deposition rates
- Increased resistance to hot cracking and porosity
- Soft, low penetrating arc for minimal base material admixture

## CONFORMANCES

**AWS A5:** E70T-4 E70T4-AZ-CS3  
**CWB/CSA:** E490T4-AZ-CS3-H16 E492T-4-H16  
**ISO:** T49 Z T4-0 NO A H15

## TYPICAL APPLICATIONS

- Open groove welds
- Machinery bases and heavy equipment repair
- Installing wear plates
- 6.4 - 12.7 mm (1/4 - 1/2 in) single pass fillet and lap welds

## WELDING POSITIONS

Flat & Horizontal

## DIAMETERS / PACKAGING

Diameter in (mm)	14 lb (6.4 kg) Coil 56 lb (25.4 kg) Master Carton	50 lb (22.7 kg) Coil	600 lb (272 kg) Speed-Feed® Drum
5/64 (2.0)	ED012739	ED012740	
3/32 (2.4)		ED012736	ED012735
0.120 (3.0)		ED012732	ED012731

## MECHANICAL PROPERTIES<sup>(1)</sup>

	Yield Strength <sup>(2)</sup> MPa (ksi)	Tensile Strength MPa (ksi)	Elongation %	Hardness Rockwell B
<b>Requirements</b> - AWS E70T-4	400 (58) min	480-655 (70-95)	22 min	-
<b>Typical Results<sup>(3)</sup></b> - As-Welded	415-450 (60-65)	580-620 (84-90)	25-28	87-91

## DEPOSIT COMPOSITION<sup>(1)</sup>

	%C	%Mn	%Si	%S	%P	%Al
<b>Requirements</b> - AWS E70T-4	0.30 max	1.75 max	0.60 max	0.03 max	0.03 max	1.8 max
<b>Typical Results<sup>(3)</sup></b>	0.21-0.25	0.37-0.53	0.25-0.29	≤0.01	≤0.01	1.3-1.6

## TYPICAL OPERATING PROCEDURES

Diameter, Polarity	CTWD mm (in)	Wire Feed Speed m/min (in/min)	Voltage (volts)	Approx. Current (amps)	Melt-Off Rate kg/hr (lb/hr)	Deposition Rate kg/hr (lb/hr)	Efficiency (%)
5/64 in (2.0 mm), DC+	54 (2 1/4)	5.1 (200)	29-31	280	5.5 (12.2)	4.6 (10.1)	83
		6.1 (240)	30-32	315	6.7 (14.8)	5.5 (12.1)	82
		6.6 (260)	30-32	330	7.3 (16.0)	6.0 (13.2)	83
		7.6 (300)	31-33	350	8.4 (18.6)	6.9 (15.2)	82
3/32 in (2.4 mm), DC+	76 (3)	2.8 (110)	28-30	250	4.6 (10.1)	3.7 (8.2)	81
		3.8 (150)	29-31	300	6.4 (14.0)	5.3 (11.7)	84
		4.7 (185)	30-32	350	7.9 (17.4)	6.6 (14.6)	84
		5.8 (230)	31-33	400	9.8 (21.6)	8.3 (18.3)	85
0.120 in (3.0 mm), DC+ Electrical Stickout: 2 - 3/4 in (70 mm)	76 (3)	7.0 (275)	32-34	450	11.8 (26.0)	10.0 (22.0)	85
		3.5 (140)	28-30	380	9.0 (19.8)	7.0 (15.5)	78
		4.4 (175)	29-31	450	11.2 (24.6)	9.1 (20.0)	81
		5.1 (200)	30-32	500	12.7 (28.0)	10.5 (23.2)	83
0.120 in (3.0 mm), DC+ Electrical Stickout: 3 - 3/4 in (95 mm)	102 (4)	7.6 (225)	31-33	550	14.2 (31.4)	11.9 (26.2)	83
		5.3 (210)	35-37	450	13.2 (29.0)	11.3 (25.0)	86
		6.4 (250)	36-38	500	15.6 (34.5)	13.2 (29.0)	84
		7.6 (300)	37-39	550	18.8 (41.5)	15.4 (34.0)	82
		9.0 (355)	38-40	600	22.2 (49.0)	18.0 (39.5)	81

<sup>(1)</sup>Typical all weld metal. <sup>(2)</sup>Measured with 0.2% offset. <sup>(3)</sup>See test results disclaimer

# INNERSHIELD® NR®-311 Ni

Low Alloy, Flat & Horizontal ▪ AWS E70T7-K2, E80TG-K2, E70T7-A2-K2-H16, E80TG-A2-K2-H16

## KEY FEATURES

- Designed to provide a nominal 1.5% nickel weld deposit
- High deposition rates and fast travel speeds
- Capable of producing weld deposits with impact properties exceeding 27 J (20 ft•lbf) at -29°C (-20°F)
- Color match on weathering steel applications
- 3/32 in (2.4 mm) diameter meets AWS D1.8 seismic lot waiver requirements

## TYPICAL APPLICATIONS

- Fillet and lap welds
- Horizontal and square edge butt welds, such as column-to-column structural connections
- Deep groove welds
- Structural fabrication
- Weathering steels

## DIAMETERS / PACKAGING

Diameter in (mm)	25 lb (11.3 kg) Steel Spool	50 lb (22.7 kg) Coil	50 lb (22.7 kg) Coil (Vacuum Sealed Foil Bag)
5/64 (2.0)	ED030650		
3/32 (2.4)		ED017822	ED032530
7/64 (2.8)		ED017824	

## MECHANICAL PROPERTIES<sup>(1)</sup>

	Yield Strength <sup>(2)</sup> MPa (ksi)	Tensile Strength MPa (ksi)	Elongation %	Hardness Rockwell B	Charpy V-Notch J (ft•lbf) @ -29°C (-20°F)
<b>Requirements</b>					
AWS E70T7-K2	400 (58) min	480-620 (70-90)	20 min	–	27 (20) min
AWS E80TG-K2	470 (68) min	550-690 (80-100)	19 min		Not Specified
<b>Typical Results<sup>(3)</sup> As-Welded</b>	470-515 (68-75)	575-615 (83-89)	27-30	88-93	41-87 (30-65)

## DEPOSIT COMPOSITION<sup>(1)</sup>

	%C	%Mn	%Si	%S	%P	%Ni	%Cr	%Mo	%V	%Al
<b>Requirements -</b>										
AWS E70T7-K2 / E80TG-K2	0.15 max	0.50-1.75	0.80 max	0.030 max	0.030 max	1.00-2.00	0.15 max	0.35 max	0.05 max	1.8 max
<b>Typical Results<sup>(3)</sup></b>	0.06-0.08	1.25-1.40	0.18-0.22	≤0.003	0.005-0.008	1.29-1.56	0.03-0.04	≤0.03	–	1.0-1.3

## TYPICAL OPERATING PROCEDURES

Diameter, Polarity	CTWD mm (in)	Wire Feed Speed m/min (in/min)	Voltage (volts)	Approx. Current (amps)	Melt-Off Rate kg/hr (lb/hr)	Deposition Rate kg/hr (lb/hr)	Efficiency (%)
5/64 in (2.0 mm), DC-	32 (1 1/4)	2.5 (100)	21-23	170	2.5 (5.5)	1.8 (3.9)	70
		3.3 (130)	24-26	205	3.3 (7.2)	2.4 (5.2)	72
		4.1 (160)	25-27	235	4.0 (8.8)	2.9 (6.5)	73
		5.1 (200)	26-28	270	5.0 (11.0)	3.8 (8.3)	75
		6.1 (240)	27-29	295	6.1 (13.3)	4.5 (10.0)	75
3/32 in (2.4 mm), DC-	38 (1 1/2)	1.9 (75)	20-22	200	2.8 (6.2)	1.9 (4.2)	67
		2.5 (100)	21-23	245	3.8 (8.3)	2.7 (5.9)	71
		3.1 (125)	23-25	285	4.7 (10.4)	3.4 (7.5)	72
		3.8 (150)	25-27	330	5.7 (12.5)	4.1 (9.1)	72
		4.4 (175)	26-28	365	6.6 (14.5)	4.9 (10.8)	74
5.1 (200)	27-29	390	7.6 (16.6)	5.6 (12.3)	74		
7/64 in (2.8 mm), DC-	44.5 (1 3/4)	2.5 (100)	22-24	310	5.2 (11.4)	3.8 (8.4)	73
		3.5 (140)	24-26	370	7.2 (15.8)	5.4 (11.8)	74
		4.3 (170)	26-28	430	8.9 (19.5)	6.6 (14.5)	74
		5.1 (200)	28-30	470	10.4 (22.8)	7.7 (17.0)	74
		6.1 (240)	29-31	520	12.4 (27.2)	9.2 (20.4)	75

<sup>(1)</sup>Typical all weld metal. <sup>(2)</sup>Measured with 0.2% offset. <sup>(3)</sup>See test results disclaimer. NOTE: FEM A and AWS D1.8 structural steel seismic supplement test data can be found on this product at [www.lincolnelectric.com](http://www.lincolnelectric.com).

# INNERSHIELD® NR®-152

Mild Steel, All Position ■ AWS E71T-14, E71T14S

## KEY FEATURES

- Designed for high speed welding of specially coated steels
- Soft, consistent arc
- Porosity resistant
- Excellent overlapping capabilities
- Ideal for robotic applications

## WELDING POSITIONS

All

## MAXIMUM PLATE THICKNESS

Diameter - in (mm)	Maximum Plate Thickness - in (mm)
1/16 (1.6)	3/16 (4.8)
0.068 (1.7)	3/16 (4.8)

## CONFORMANCES

**AWS A5:** E71T-14 E71T14S

**ISO:** T49 T14-1 NO S A-G

## TYPICAL APPLICATIONS

- Single pass welding on thicknesses from 0.8 mm - 4.8 mm (0.030 in - 3/16 in)
- Continuous welding on galvanized or zinc coated carbon steel
- Spot or short intermittent welds
- Automotive
- Transportation

## WARNING

- NR-152 is NOT recommended for welding multiple passes

## DIAMETERS / PACKAGING

Diameter in (mm)	25 lb (11.3 kg) Plastic Spool	50 lb (22.7 kg) Coil	500 lb (227 kg) Speed-Feed® Drum	500 lb (227 kg) Accu-Trak® Drum
0.045 (1.1)	EDS01702	ED012185 ED012186	ED024301	ED028123 ED029066
0.062 (1.6)				
0.068 (1.7)				

## MECHANICAL PROPERTIES<sup>(1)</sup>

	Transverse Tensile Strength MPa (ksi)	Longitudinal Bend Test	Hardness Rockwell B
<b>Requirements</b> - AWS E71T-14	480 (70) min	180° over 3/4 in Radius / No openings exceeding 1/8 in	—
<b>Typical Results</b> <sup>(2)</sup>	480-550 (70-80)	Passed	93

## DEPOSIT COMPOSITION<sup>(1)</sup>

	%C	%Mn	%Si	%S	%P	%Al
<b>Requirements</b> - AWS E71T-14	Not Specified					
<b>Typical Results</b> <sup>(2)</sup>	0.25-0.30	0.83-1.04	0.20-0.23	0.006-0.01	0.005-0.02	1.08-1.38

## TYPICAL OPERATING PROCEDURES

Diameter, Polarity	CTWD mm (in)	Wire Feed Speed m/min (in/min)	Voltage (volts)	Approx. Current (amps)	Melt-Off Rate kg/hr (lb/hr)	Deposition Rate kg/hr (lb/hr)	Efficiency (%)
1/16 in (1.6 mm), DC-	16 (5/8)	0.8 (30)	13-14	90	0.5 (1.3)	0.5 (1.2)	92
		1.0 (40)	14-15	115	0.8 (1.8)	0.7 (1.6)	88
		1.3 (50)	15-16	140	0.9 (2.2)	0.9 (2.0)	90
		1.8 (70)	16-17	185	1.4 (3.1)	1.3 (2.8)	90
		2.8 (110)	19-20	265	2.1 (4.8)	2.0 (4.4)	91
0.068 in (1.7 mm), DC-	19 (3/4)	0.8 (30)	13-14	68	0.7 (1.6)	0.6 (1.4)	87
		1.0 (40)	13-14	95	0.9 (2.2)	0.9 (1.9)	86
		1.3 (50)	14-15	120	1.2 (2.7)	1.1 (2.4)	88
		1.5 (60)	15-16	145	1.4 (3.3)	1.3 (2.9)	87
		2.0 (80)	16-17	190	1.9 (4.4)	1.8 (3.9)	88
2.8 (110)	20-21	240	2.7 (6.0)	2.4 (5.4)	90		

<sup>(1)</sup>Typical all weld metal. <sup>(2)</sup>See test results disclaimer

NOTE: The preferred drag angle is 15°, however, NR-152 is capable of welding at zero drag angle, facilitating easy fixturing in automatic applications.

# INNERSHIELD® NR®-203-MP

Mild Steel, All Position ■ AWS E71T-8-JH8, E71T8-A4-CS3-H8

## KEY FEATURES

- Designed to handle poor fit-up on heavy wall tubes and gaps up to 9.5 mm (3/8 in) with 6.4 mm (1/4 in) offset
- Fast freezing slag with excellent wash-in
- Root bead capability without back-up bars

## TYPICAL APPLICATIONS

- General plate fabrication, including bridge fabrication, hull plate and stiffener welding on ships and barges
- Storage tanks
- Structural welding
- Offshore welding in TKY joints

## CONFORMANCES

- AWS A5:** E71T8-A4-CS3-H8, E71T-8-JH8  
**ABS:** 3YSA H15  
**CWB/CSA:** E491T8-A3-CS3-H8, E491T-8-H8  
**DNV:** III YMS H10  
**Lloyd's Register:** 3YS H15  
**BV:** SA3YMH  
**ISO:** T49 4 T8-1 NO A H10

## WELDING POSITIONS

All

## DIAMETERS / PACKAGING

Diameter in (mm)	14 lb (6.4 kg) Coil 56 lb (25.4 kg) Master Carton	25 lb (11.3 kg) Steel Spool
0.068 (1.7) 5/64 (2.0)	ED021604	ED030640

## MECHANICAL PROPERTIES<sup>(1)</sup>

	Yield Strength <sup>(2)</sup> MPa (ksi)	Tensile Strength MPa (ksi)	Elongation %	Hardness Rockwell B	Charpy V-Notch J (ft-lbf)	
					@ -29°C (-20°F)	@ -40°C (-40°F)
<b>Requirements - AWS E71T-8-J</b>	400 (58) min	480-655 (70-95)	22 min	–	Not Specified	27 (20) min
<b>Typical Results<sup>(3)</sup></b>	415-440 (60-64)	510-545 (74-79)	29-33	82-87	75-203 (55-150)	68-224 (50-165)

## DEPOSIT COMPOSITION<sup>(1)</sup>

	%C	%Mn	%Si	%S	%P	%Al
<b>Requirements - AWS E71T-8-J</b>	0.30 max	1.75 max	0.60 max	0.03 max	0.03 max	1.8 max
<b>Typical Results<sup>(3)</sup></b>	0.04-0.07	1.35-1.47	0.22-0.32	≤0.01	≤0.01	0.8-1.0

## TYPICAL OPERATING PROCEDURES

Diameter, Polarity	CTWD mm (in)	Wire Feed Speed m/min (in/min)	Voltage (volts)	Approx. Current (amps)	Melt-Off Rate kg/hr (lb/hr)	Deposition Rate kg/hr (lb/hr)	Efficiency (%)
0.068 in (1.7 mm), DC-	25 (1)	1.8 (70)	16-17	145	1.5 (3.3)	1.0 (2.3)	69
		2.3 (90)	18-19	180	1.9 (4.2)	1.5 (3.2)	76
		3.0 (120)	20-21	225	2.5 (5.6)	2.0 (4.3)	76
		3.5 (140)	21-22	255	2.9 (6.4)	2.2 (4.8)	75
		3.8 (150)	23-24	265	3.1 (6.8)	2.3 (5.1)	75
5/64 in (2.0 mm), DC-	25 (1)	1.3 (50)	16-17	130	1.4 (3.1)	0.9 (1.9)	61
		1.8 (70)	18-19	180	2.0 (4.3)	1.3 (2.9)	67
		2.3 (90)	19-20	220	2.5 (5.6)	1.9 (4.2)	75
		2.8 (110)	20-21	260	3.1 (6.8)	2.4 (5.3)	77
		3.0 (120)	21-22	280	3.4 (7.4)	2.7 (5.9)	79
3.5 (140)	22-23	310	3.9 (8.7)	3.1 (6.8)	79		

<sup>(1)</sup>Typical all weld metal. <sup>(2)</sup>Measured with 0.2% offset. <sup>(3)</sup>See test results disclaimer



# INNERSHIELD® NR®-211-MP

Mild Steel, All Position ▪ AWS E71T-11, E71T11-AZ-CS3

## KEY FEATURES

- Versatile welding capability on a variety of base materials
- High operator appeal and good bead appearance
- Easy slag removal
- Fast freezing characteristics accommodate poor fit-up

## CONFORMANCES

- AWS A5:** E71T-11 E71T11-AZ-CS3  
**ABS:** E71T-11  
**CWB/CSA:** E491T-11-H16  
**ISO:** T49 Z T11-1 NO A H15

## WELDING POSITIONS

All, except 3/32 in (2.4 mm) diameter

## MAXIMUM PLATE THICKNESS

Diameter - in (mm)	Maximum Plate Thickness - in (mm)
0.030 (0.8)	5/16 (7.9)
0.035 (0.9)	5/16 (7.9)
0.045 (1.1)	5/16 (7.9)
0.068 (1.7)	1/2 (12.7)
5/64 (2.0)	1/2 (12.7)
3/32 (2.4)	1/2 (12.7)

## TYPICAL APPLICATIONS

- Sheet or thin gauge metal
- Galvanized sheet metal
- Robotic / hard automation
- General fabrication
- 5/16 in. maximum plate thickness for 0.045 in. and smaller diameters
- 1/2 in. maximum plate thickness for 0.068 - 3/32 in. diameters

## DIAMETERS / PACKAGING

Diameter in (mm)	1 lb (0.5 kg) Plastic Spool 5 lb (2.3 kg) Master Carton	10 lb (4.5 kg) Plastic Spool	14 lb (6.4 kg) Coil 56 lb (25.4 kg) Master Carton
0.030 (0.8)	ED031448	ED033130	
0.035 (0.9)	ED030584	ED016354	
0.045 (1.1)		ED016363	
0.068 (1.7)			ED012506
5/64 (2.0)			ED012508
3/32 (2.4)			
Diameter in (mm)	25 lb (11.3 kg) Steel Spool	50 lb (22.7 kg) Coil	500 lb (227 kg) Accu-Trak® Drum
0.030 (0.8)			
0.035 (0.9)	ED030637		
0.045 (1.1)	ED030638		
0.068 (1.7)	ED030641	ED012507	
5/64 (2.0)	ED030645	ED012509	ED029838
3/32 (2.4)		ED013869	ED029028

**MECHANICAL PROPERTIES<sup>(1)</sup>**

	Yield Strength <sup>(2)</sup> MPa (ksi)	Tensile Strength MPa (ksi)	Elongation %	Hardness Rockwell B
<b>Requirements</b> - AWS E71T-11	400 (58) min	480-655 (70-95)	20 min	-
<b>Typical Results<sup>(3)</sup></b>	435-475 (63-69)	605-645 (88-94)	22-25	89-92

**DEPOSIT COMPOSITION<sup>(1)</sup>**

	%C	%Mn	%Si	%S	%P	%Al
<b>Requirements</b> - AWS E71T-11	0.30 max	1.75 max	0.60 max	0.03 max	0.03 max	1.8 max
<b>Typical Results<sup>(3)</sup></b>	0.23-0.26	0.57-0.66	0.17-0.26	≤0.01	≤0.01	1.3-1.6

**TYPICAL OPERATING PROCEDURES**

Diameter, Polarity	CTWD mm (in)	Wire Feed Speed m/min (in/min)	Voltage (volts)	Approx. Current (amps)	Melt-Off Rate kg/hr (lb/hr)	Deposition Rate kg/hr (lb/hr)	Efficiency (%)
0.030 in (0.8 mm), DC-	13 (1/2)	1.3 (50)	13-14	30	0.2 (0.5)	0.2 (0.4)	81
		2.5 (100)	13-14	60	0.5 (1.1)	0.4 (0.8)	75
		3.8 (150)	14-15	80	0.7 (1.6)	0.6 (1.2)	78
		5.1 (200)	14-15	100	1.0 (2.1)	0.8 (1.7)	81
		6.4 (250)	15-16	130	1.2 (2.6)	1.0 (2.1)	80
		7.6 (300)	18-19	140	1.4 (3.2)	1.2 (2.6)	81
0.035 in (0.9 mm), DC-	13-16 (1/2-5/8)	1.3 (50)	14-15	30	0.4 (0.8)	0.3 (0.7)	81
		1.8 (70)	15-16	60	0.5 (1.2)	0.5 (1.0)	83
		2.8 (110)	16-17	115	0.7 (1.6)	0.6 (1.3)	78
		3.8 (150)	17-18	130	1.0 (2.2)	0.8 (1.7)	78
		5.1 (200)	18-19	155	1.4 (3.0)	1.1 (2.5)	84
		7.0 (275)	20-21	155	2.0 (4.4)	1.5 (3.4)	78
0.045 in (1.1 mm), DC-	16 (5/8)	1.8 (70)	15-16	120	0.7 (1.6)	0.5 (1.1)	69
		2.3 (90)	16-17	140	1.0 (2.2)	0.8 (1.7)	77
		2.8 (110)	17-18	160	1.2 (2.7)	1.0 (2.3)	85
		3.3 (130)	18-19	170	1.5 (3.2)	1.2 (2.7)	84
0.068 in (1.7 mm), DC-	19-32 (3/4-1 1/4)	1.0 (40)	15-16	125	1.0 (2.1)	0.8 (1.7)	81
		1.9 (75)	18-19	190	1.8 (4.0)	1.5 (3.4)	85
		3.3 (130)	20-21	270	3.2 (7.0)	2.8 (6.1)	88
		4.4 (175)	23-24	300	4.3 (9.4)	3.8 (8.4)	89
5/64 in (2.0 mm), DC-	19-32 (3/4-1 1/4)	1.3 (50)	16-17	180	1.6 (3.5)	1.3 (2.9)	83
		1.9 (75)	18-19	235	2.4 (5.3)	2.0 (4.5)	85
		3.0 (120)	20-21	290	3.8 (8.4)	3.4 (7.4)	88
		4.1 (160)	22-23	325	5.1 (11.2)	4.5 (10.0)	89
3/32 in (2.4 mm), DC-	19-32 (3/4-1 1/4)	1.3 (50)	16-17	245	2.3 (5.0)	1.9 (4.2)	84
		1.9 (75)	19-20	305	3.4 (7.5)	2.9 (6.4)	85
		2.5 (100)	20-21	365	4.5 (10.0)	3.9 (8.7)	87
		3.3 (130)	22-23	400	5.9 (12.9)	5.1 (11.3)	88

<sup>(1)</sup>Typical all weld metal. <sup>(2)</sup>Measured with 0.2% offset. <sup>(3)</sup>See test results disclaimer

# INNERSHIELD® NR®-232

Mild Steel, All Position ■ AWS E71T-8, E71T8-A2-CS3-H16

## KEY FEATURES

- High deposition rates for out-of-position welding
- Penetrating arc
- Fast freezing, easy to remove slag system
- Meets AWS D1.8 seismic lot waiver requirements

## WELDING POSITIONS

All

## TYPICAL APPLICATIONS

- Structural fabrication, including those subject to seismic requirements
- General plate fabrication
- Hull plate and stiffener welding on ships and barges
- Machinery parts, tanks, hoppers, racks and scaffolding

## CONFORMANCES

<b>AWS A5:</b>	E71T8-A2-CS3-H16, E71T-8-H16
<b>ABS:</b>	3YSA
<b>CWB/CSA:</b>	E491T8-A3-CS3-H16, E491T-8-H16
<b>DNV:</b>	III YMS H15
<b>Lloyd's Register:</b>	3YS H15
<b>BV:</b>	SA3YMH
<b>AWS D1.8:</b>	0.068", 0.072", 5/64"
<b>ISO:</b>	T55 3 T8-1 NO A H15
<b>JIS:</b>	T49 3 T7-1 N A

## DIAMETERS / PACKAGING

Diameter in (mm)	13.5 lb (6.1 kg) Coil 54 lb (24.5 kg) Master Carton	13.5 lb (6.1 kg) Coil 54 lb (24.5 kg) Hermetically Sealed Pail	25 lb (11.3 kg) Steel Spool
0.068 (1.7)	ED012518	ED030232	ED030643
0.072 (1.8)	ED012522		ED030644
5/64 (2.0)	ED012525		ED030647
Diameter in (mm)	25 lb (11.3 kg) Plastic Spool (Vacuum Sealed Foil Bag)		50 lb (22.7 kg) Coil
0.068 (1.7)	ED030949		ED012519
0.072 (1.8)			ED012523
5/64 (2.0)			ED012526

**MECHANICAL PROPERTIES<sup>(1)</sup>**

	Yield Strength <sup>(2)</sup> MPa (ksi)	Tensile Strength MPa (ksi)	Elongation %	Hardness Rockwell B	Charpy V-Notch / J ft-lbf) @ -29°C (-20°F)
<b>Requirements</b> - AWS E71T-8	400 (58) min	480-655 (70-95)	22 min	–	27 (20) min
<b>Typical Results<sup>(3)</sup></b> - As-Welded	460-520 (66-75)	575-615 (83-89)	25-31	87-90	47-75 (35-55)

**DEPOSIT COMPOSITION<sup>(1)</sup>**

	%C	%Mn	%Si	%S	%P	%Al
<b>Requirements</b> - AWS E71T-8	0.30 max	1.75 max	0.60 max	0.03 max	0.03 max	1.8 max
<b>Typical Results<sup>(3)</sup></b>	0.16-0.18	0.61-0.72	0.26-0.33	≤0.01	≤0.01	0.5-0.8

**TYPICAL OPERATING PROCEDURES**

Diameter, Polarity	CTWD <sup>(6)</sup> mm (in)	Wire Feed Speed m/min (in/min)	Voltage <sup>(7)</sup> (volts)	Approx. Current (amps)	Melt-Off Rate kg/hr (lb/hr)	Deposition Rate kg/hr (lb/hr)	Efficiency (%)
0.068 in (1.7 mm), DC-	19-32 (3/4-1 1/4)	2.8 (110)	18-19	195	2.3 (5.0)	1.8 (3.9)	78
		3.3 (130)	19-21	225	2.8 (6.2)	2.0 (4.6)	74
		3.8 (150)	19-21	250	3.2 (7.1)	2.4 (5.3)	75
		4.3 (170)	20-22	270	3.5 (7.8)	2.8 (6.1)	78
		5.0 (195)	23-24	300	4.3 (9.4)	3.2 (7.0)	74
		6.4 (250)	23-24	350	5.4 (11.8)	4.0 (9.0)	76
		7.4 (320)	25-27	400	6.9 (15.2)	5.2 (11.4)	75
0.072 in (1.8 mm), DC-	19-32 (3/4-1 1/4)	2.0 (80)	16-18	130	1.8 (4.0)	1.5 (3.3)	83
		3.5 (140)	18-21	225	3.1 (6.8)	2.5 (5.5)	81
		3.9 (155)	19-22	240	3.3 (7.2)	2.7 (6.0)	83
		4.3 (170)	20-23	255	3.6 (8.0)	2.9 (6.5)	81
		6.4 (250)	22-24	315	5.3 (11.7)	4.3 (9.6)	82
		7.4 (290)	23-25	350	6.2 (13.6)	5.0 (11.0)	81
5/64 in (2.0 mm), DC-	19-32 (3/4-1 1/4)	1.5 (60)	16-17	145	1.7 (3.7)	1.2 (2.7)	73
		2.9 (115)	19-20	260	3.2 (7.0)	2.5 (5.5)	78
		3.0 (120)	19-20	270	3.3 (7.3)	2.6 (5.7)	78
		3.3 (130)	20-21	285	3.5 (7.8)	2.8 (6.2)	79
		4.6 (180)	22-23	365	5.0 (10.9)	3.9 (8.7)	80

<sup>(1)</sup>Typical all weld metal. <sup>(2)</sup>Measured with 0.2% offset. <sup>(3)</sup>See test results disclaimer  
NOTE: FEMA 353 and AWS D1.8 structural steel seismic supplement test data can be found on this product at [www.lincolnelectric.com](http://www.lincolnelectric.com).

# INNERSHIELD® NR®-232-H

Mild Steel, All Position ■ AWS E71T-8-H8, E71T8-A2-CS3-H8

## KEY FEATURES

- High deposition rates for out-of-position welding
- Penetrating arc
- Fast freezing, easy to remove slag system

## CONFORMANCES

<b>AWS A5:</b>	E71T8-A2-CS3-H8, E71T-8-H8
<b>CWB/CSA:</b>	E491T-8-H8
<b>AWS D1.8:</b>	0.068", 0.072"

## WELDING POSITIONS

All

## TYPICAL APPLICATIONS

- Structural fabrication, including those subject to seismic requirements
- General plate fabrication
- Machinery parts, tanks, hoppers, racks and scaffolding

## DIAMETERS / PACKAGING

Diameter in (mm)	25 lb (11.3 kg) Plastic Spool (Vacuum Sealed Foil Bag)
0.068 (1.7)	ED036677
0.072 (1.8)	ED036678

## MECHANICAL PROPERTIES<sup>(1)</sup>

	Yield Strength <sup>(2)</sup> MPa (ksi)	Tensile Strength MPa (ksi)	Elongation %	Hardness Rockwell B	Charpy V-Notch / J (ft-lbf) @ -29°C (-20°F)
<b>Requirements</b> - AWS E71T-8-H8	400 (58) min	480-655 (70-95)	22 min	–	27 (20) min
<b>Typical Results<sup>(3)</sup></b> - As-Welded	460-520 (66-75)	575-615 (83-89)	25-31	87-90	47-75 (35-55)

<sup>(1)</sup>Typical all weld metal. <sup>(2)</sup>Measured with 0.2% offset. <sup>(3)</sup>See test results disclaimer

**DEPOSIT COMPOSITION<sup>(1)</sup>**

	%C	%Mn	%Si	%S	%P	%Al	Diffusible Hydrogen (mL/100g weld deposit)
<b>Requirements - AWS E71T-8-H8</b>	0.30 max	1.75 max	0.60 max	0.03 max	0.03 max	1.8 max	8.0 max
<b>Typical Results<sup>(3)</sup></b>	0.16-0.18	0.61-0.72	0.26-0.33	≤0.01	≤0.01	0.5-0.8	5-7

**TYPICAL OPERATING PROCEDURES**

Diameter, Polarity	CTWD <sup>(6)</sup> mm (in)	Wire Feed Speed m/min (in/min)	Voltage <sup>(7)</sup> (volts)	Approx. Current (amps)	Melt-Off Rate kg/hr (lb/hr)	Deposition Rate kg/hr (lb/hr)	Efficiency (%)
0.068 in (1.7 mm), DC-	19-32 (3/4-1 1/4)	2.8 (110)	18-19	195	2.3 (5.0)	1.8 (3.9)	78
		3.3 (130)	19-21	225	2.8 (6.2)	2.0 (4.6)	74
		3.8 (150)	19-21	250	3.2 (7.1)	2.4 (5.3)	75
		4.3 (170)	20-22	270	3.5 (7.8)	2.8 (6.1)	78
		5.0 (195)	23-24	300	4.3 (9.4)	3.2 (7.0)	74
		6.4 (250)	23-24	350	5.4 (11.8)	4.0 (9.0)	76
		7.4 (320)	25-27	400	6.9 (15.2)	5.2 (11.4)	75
0.072 in (1.8 mm), DC-	19-32 (3/4-1 1/4)	2.0 (80)	16-18	130	1.8 (4.0)	1.5 (3.3)	83
		3.5 (140)	18-21	225	3.1 (6.8)	2.5 (5.5)	81
		3.9 (155)	19-22	240	3.3 (7.2)	2.7 (6.0)	83
		4.3 (170)	20-23	255	3.6 (8.0)	2.9 (6.5)	81
		6.4 (250)	22-24	315	5.3 (11.7)	4.3 (9.6)	82
		7.4 (290)	23-25	350	6.2 (13.6)	5.0 (11.0)	81

<sup>(1)</sup>Typical all weld metal. <sup>(2)</sup>Measured with 0.2% offset. <sup>(3)</sup>See test results disclaimer  
NOTE: AWS D1.8 structural steel seismic supplement test data can be found on this product at [www.lincolnelectric.com](http://www.lincolnelectric.com).

# INNERSHIELD® NR®-233

Mild Steel, All Position ■ AWS E71T-8-H8, E71T8-A2-CS3-H8



## KEY FEATURES

- High deposition rates for out-of-position welding
- Welder-friendly, easy to use and great bead appearance
- Minimal gas marking
- Meets AWS D1.8 seismic lot waiver requirements

## CONFORMANCES

- AWS A5:** E71T8-A2-CS3-H8, E71T-8-H8
- ABS:** E71T-8-H16
- AWS D1.8:** 0.072", 1/16", 5/64"
- ISO:** T49 3 T8-1 NO A H10

## WELDING POSITIONS

All

## NOTES

- Innershield® K126 Gun Assembly requires one of the following gun tube assemblies for better wire feeding - KP2454-1 (62°, 7.5 in), KP2455-1 (45°, 6 in), KP2456-1 (30°, 12 in)

## TYPICAL APPLICATIONS

- Structural fabrication, including those subject to seismic requirements
- General plate fabrication
- Ship and barge fabrication
- Vertical up and overhead fillets and groove welds

## DIAMETERS / PACKAGING

Diameter in (mm)	12.5 lb (5.7 kg) Plastic Spool 50 lb (22.7 kg) Master Carton	25 lb (11.3 kg) Plastic Spool	25 lb (11.3 kg) Plastic Spool (Vacuum Sealed Foil Bag)
1/16 (1.6)	ED030933	ED030934	ED031576, ED036576*
0.072 (1.8)		ED031030	
5/64 (2.0)		ED033039	ED033024, ED036577*

\*Buy America Product

## MECHANICAL PROPERTIES<sup>(1)</sup>

	Yield Strength <sup>(2)</sup> MPa (ksi)	Tensile Strength MPa (ksi)	Elongation %	Hardness Rockwell B	Charpy V-Notch J (ft·lbf) @ -29°C (-20°F)
<b>Requirements</b> - AWS E71T-8-H8	400 (58) min	480-655 (70-95)	22 min	—	27 (20) min
<b>Typical Results<sup>(3)</sup></b> - As-Welded	435-455 (63-66)	575-595 (83-86)	26-29	87-89	34-54 (25-40)

<sup>(1)</sup>Typical all weld metal. <sup>(2)</sup>Measured with 0.2% offset. <sup>(3)</sup>See test results disclaimer.

**DEPOSIT COMPOSITION<sup>(1)</sup>**

	%C	%Mn	%Si	%S	%P	%Al
<b>Requirements - AWS E71T-8-H8</b>	0.30 max	1.75 max	0.60 max	0.03 max	0.03 max	1.8 max
<b>Typical Results<sup>(3)</sup></b>	0.15-0.20	0.61-0.65	0.17-0.21	≤0.03	≤0.01	0.5-0.6

**TYPICAL OPERATING PROCEDURES**

Diameter, Polarity	CTWD <sup>(4)</sup> mm (in)	Wire Feed Speed m/min (in/min)	Voltage (volts)	Approx. Current (amps)	Melt-Off Rate kg/hr (lb/hr)	Deposition Rate kg/hr (lb/hr)	Efficiency (%)
1/16 in (1.6 mm), DC-	25 (1)	3.8 (150)	17-19	220	2.4 (5.3)	1.9 (4.2)	80
		5.1 (200)	19-21	245	3.2 (7.1)	2.5 (5.4)	76
		6.4 (250)	21-23	270	4.0 (8.9)	3.0 (6.6)	74
		7.6 (300)	23-25	295	4.7 (10.4)	3.5 (7.7)	75
		8.9 (350)	25-27	315	5.6 (12.3)	4.3 (9.4)	77
0.072 in (1.8 mm), DC-	19-25 (3/4-1) <sup>(4)</sup>	2.5 (100)	17-18	184	2.0 (4.5)	1.6 (3.6)	80
		3.8 (150)	18-19	250	3.1 (6.7)	2.5 (5.4)	80
		5.1 (200)	20-21	295	4.0 (8.9)	3.2 (7.1)	81
		6.4 (250)	22-23	330	5.1 (11.2)	4.0 (8.9)	79
		7.6 (300)	23-24	355	6.1 (13.4)	4.8 (10.6)	79
5/64 in (2.0 mm), DC-	19-25 (3/4-1) <sup>(4)</sup>	2.3 (90)	18-19	210	2.2 (4.9)	1.8 (4.1)	82
		3.2 (125)	19-20	260	3.2 (7.0)	2.6 (5.6)	81
		3.8 (150)	20-21	300	3.8 (8.4)	3.0 (6.7)	80
		5.1 (200)	21-22	340	5.1 (11.2)	4.1 (9.0)	81
		6.1 (240)	22-23	380	6.1 (13.3)	4.9 (10.8)	81

<sup>(1)</sup>Typical all weld metal. <sup>(2)</sup>Measured with 0.2% offset. <sup>(3)</sup>See test results disclaimer <sup>(4)</sup>CTWD for 0.072 in. (1.8 mm) and 5/64 in. (2.0 mm) for 200 ipm or greater is 1 in (25 mm).  
NOTE: For horizontal welding, subtract 1 volt. NOTE: FEMA and AWS D1.8 structural steel seismic supplement test data can be found on this product at [www.lincolnelectric.com/d1.8](http://www.lincolnelectric.com/d1.8).



# INNERSHIELD® NR®-203 NICKEL (1%)

Low Alloy, All Position ▪ AWS E71T8-Ni1, E71T8-A2-Ni1-H16

## KEY FEATURES

- Designed to produce a nickel bearing weld deposit
- Capable of producing weld deposits with impact toughness capable of exceeding 27 J (20 ft•lbf) at -29°C (-20°F)
- Color match on weathering steels
- Handles poor fit-up
- Root bead capability

## TYPICAL APPLICATIONS

- Roundabout groove welds on heavy wall tubular construction
- Offshore
- Structural fabrication
- Bridges and other structural components made from weathering steels
- NACE applications

## CONFORMANCES

<b>AWS A5:</b>	E71T8-A2-Ni1-H16, E71T8-Ni1-H16
<b>ABS:</b>	3YSA
<b>CWB/CSA:</b>	E491T8-A3-Ni1-H16, E491T8-Ni1-H16
<b>DNV:</b>	III YMS H10
<b>Lloyd's Register:</b>	3YS H15
<b>ISO:</b>	T49 4 T8-1 NO A-N2 H15

## WELDING POSITIONS

All

## DIAMETERS / PACKAGING

Diameter in (mm)	14 lb (6.4 kg) Coil 56 lb (25.4 kg) Master Carton	50 lb (22.7 kg) Coil
5/64 (2.0)	ED012385	ED012386

## MECHANICAL PROPERTIES<sup>(1)</sup>

	Yield Strength <sup>(2)</sup> MPa (ksi)	Tensile Strength MPa (ksi)	Elongation %	Hardness Rockwell B	Charpy V-Notch J (ft•lbf) @ -29°C (-20°F)
<b>Requirements</b> - AWS E71T8-Ni1	400 (58) min	480-620 (70-90)	20 min	–	27 (20) min
<b>Typical Results<sup>(3)</sup></b> - As-Welded	450-480 (65-70)	545-575 (79-83)	27-32	86-90	81-156 (60-115)

## DEPOSIT COMPOSITION<sup>(1)</sup>

	%C	%Mn	%Si	%S	%P
<b>Requirements</b> - AWS E71T8-Ni1	0.12 max	1.50 max	0.80 max	0.030 max	0.030 max
<b>Typical Results<sup>(3)</sup></b>	0.05-0.07	1.10-1.22	0.30-0.33	≤0.010	0.005-0.008
	%Ni	%Cr	%Mo	%V	%Al
<b>Requirements</b> - AWS E71T8-Ni1	0.80-1.10	0.15 max	0.35 max	0.05 max	1.8 min
<b>Typical Results<sup>(3)</sup></b>	0.89-1.05	0.02-0.03	0.01-0.02	≤0.01	0.8-1.0

## TYPICAL OPERATING PROCEDURES

Diameter, Polarity	CTWD mm (in)	Wire Feed Speed m/min (in/min)	Voltage (volts)	Approx. Current (amps)	Melt-Off Rate kg/hr (lb/hr)	Deposition Rate kg/hr (lb/hr)	Efficiency (%)
5/64 in (2.0 mm), DC-	25 (1)	1.3 (50)	16-17	145	1.4 (3.0)	1.0 (2.3)	76
		1.8 (70)	18-19	195	2.0 (4.3)	1.5 (3.3)	76
		2.3 (90)	19-20	240	2.5 (5.5)	2.0 (4.3)	78
		2.8 (110)	20-21	275	3.0 (6.7)	2.4 (5.3)	79
		3.0 (120)	21-22	290	3.3 (7.3)	2.6 (5.8)	79
		3.5 (140)	22-23	310	3.9 (8.5)	3.0 (6.9)	81

<sup>(1)</sup>Typical all weld metal. <sup>(2)</sup>Measured with 0.2% offset. <sup>(3)</sup>See test results disclaimer

# INNERSHIELD® NR®-203 Ni C PLUS-H

Low Alloy, All Position ▪ AWS E71T8-K2, E71T8-A2-K2

## KEY FEATURES

- A good choice for weathering steels
- Handles poor fit-up in the vertical up position
- Produces a nickel alloyed weld deposit (1.0-2.0%)
- Capable of meeting H8 diffusible hydrogen requirements

## WELDING POSITIONS

All

## CONFORMANCES

<b>AWS A5.29:</b>	E71T8-K2
<b>AWS A5.36:</b>	E71T8-A2-K2
<b>ASME SFA-5.29:</b>	E71T8-K2

## TYPICAL APPLICATIONS

- Offshore welding applications
- Roundabout groove welds on heavy wall tubular construction
- Structural fabrication
- General plate fabrication including bridges
- Hull plate and stiffener welding on ships and barges

## DIAMETERS / PACKAGING

Diameter in (mm)	14 lb (6.4 kg) Coil 56 lb (25.4 kg) Hermetically Sealed Pail
5/64 (2.0)	ED033040

## MECHANICAL PROPERTIES<sup>(1)</sup>

	Yield Strength <sup>(2)</sup> MPa (ksi)	Tensile Strength MPa (ksi)	Elongation %	Charpy V-Notch J (ft-lbf) @ -29°C (-20°F)
<b>Requirements<sup>(4)</sup> - AWS E71T8-K2</b>	400 (58) min	480-620 (70-90)	20 min	27 (20) min
<b>Typical Results<sup>(3)</sup></b>	435-520 (63-76)	530-600 (77-87)	25-30	98-161

## DEPOSIT COMPOSITION<sup>(1)</sup>

	%C	%Mn	%Si	%S	%P	%Ni
<b>Requirements - AWS E71T8-K2</b>	0.15 max	0.50-1.75	0.80 max	0.03 max	0.03 max	1.00-2.00
<b>Typical Results<sup>(3, 4)</sup></b>	0.04-0.07	0.74-0.85	0.06-0.09	≤0.01	≤0.01	1.00-1.21
	%Cr	%Mo	%V	%Al	Diffusible Hydrogen (mL/100g weld deposit)	
<b>Requirements - AWS E71T8-K2</b>	0.15 max	0.35 max	0.05 max	1.8 max	Not Specified	
<b>Typical Results<sup>(3, 4)</sup></b>	0.09-0.13	0.01-0.05	<0.01	0.65-1.12	5-8	

## TYPICAL OPERATING PROCEDURES

Diameter, Polarity	CTWD mm (in)	Wire Feed Speed m/min (in/min)	Voltage (volts)	Approx. Current (amps)	Melt-Off Rate kg/hr (lb/hr)	Deposition Rate kg/hr (lb/hr)	Efficiency (%)
5/64 in (2.0 mm), DC-	19 - 25 (3/4 - 1)	1.3 (50)	16-17	115	3.2 (1.5)	2.3 (1.0)	72
		1.8 (70)	17-18	170	4.5 (2.0)	3.3 (1.5)	73
		2.3 (90)	19-20	210	5.8 (2.6)	4.4 (2.0)	76
		2.8 (110)	20-21	245	7.0 (3.2)	5.5 (2.5)	79

<sup>(1)</sup>Typical all weld metal. <sup>(2)</sup>Measured with 0.2% offset. <sup>(3)</sup>See test results disclaimer <sup>(4)</sup>The strength and elongation properties reported were obtained from a 0.505 in (2.8 mm) tensile specimen artificially aged at 104°C (220°F) for 48 hours, as permitted by AWS A5.29-98. A naturally aged tensile specimen may take months to achieve the specified properties. The time required for the natural aging of weld deposits is dependent upon ambient conditions, weldment geometry, the metallurgical structure of the weld deposit and other factors.

# INNERSHIELD® NR®-207

Low Alloy, All Position ▪ AWS E71T8-K6, E71T8-A2-K6-H16

## KEY FEATURES

- Vertical down hot, fill and cap passes on standard cross-country pipelines and arctic grade pipe
- Recommended for API grades X42 up to undermatching X70
- High deposition rates

## TYPICAL APPLICATIONS

- Standard cross-country pipelines
- Arctic grade pipe up to undermatched X70

## CONFORMANCES

- AWS A5:** E71T8-A2-K6-H16, E71T8-K6-H16
- ABS:** E71T8-K6
- CWB/CSA:** E491T8-A3-K6-H16, E491T8-K6-H16
- DNV:** III YMS H15
- BV:** SA3YMH
- ISO:** T49 3 T8-1 NO A-N1 H15

## WELDING POSITIONS

All

## DIAMETERS / PACKAGING

Diameter in (mm)	14 lb (6.4 kg) Coil	56 lb (25.4 kg) Hermetically Sealed Pail
0.068 (1.7)	ED016312	ED012438
5/64 (2.0)		

## MECHANICAL PROPERTIES<sup>(1)</sup>

	Yield Strength <sup>(2)</sup> MPa (ksi)	Tensile Strength MPa (ksi)	Elongation %	Hardness Rockwell B	Charpy V-Notch J (ft-lbf) @ -29°C (-20°F)
<b>Requirements<sup>(4)</sup> - AWS E71T8-K6</b>	400 (58) min	480-620 (70-90)	20 min	–	27 (20) min
<b>Typical Results<sup>(3)</sup></b>	415-445 (60-64)	520-545 (75-79)	29-33	84-87	81-237 (60-175)

## DEPOSIT COMPOSITION<sup>(1)</sup>

	%C	%Mn	%Si	%S	%P
<b>Requirements - AWS E71T8-K6</b>	0.15 max	0.50-1.50	0.80 max	0.030 max	0.030 max
<b>Typical Results<sup>(3)</sup></b>	0.05-0.07	0.87-0.96	0.23-0.27	≤0.003	0.004-0.008
	%Ni	%Cr	%Mo	%V	%Al
<b>Requirements - AWS E71T8-K6</b>	0.40-1.00	0.20 max	0.15 max	0.05 max	1.8 max
<b>Typical Results<sup>(3)</sup></b>	0.73-0.83	0.02-0.03	0.02-0.03	≤0.01	0.9-1.1

## TYPICAL OPERATING PROCEDURES

Diameter, Polarity	CTWD mm (in)	Wire Feed Speed m/min (in/min)	Voltage (volts)	Approx. Current (amps)	Melt-Off Rate kg/hr (lb/hr)	Deposition Rate kg/hr (lb/hr)	Efficiency (%)
0.068 in (1.7 mm), DC-	25 (1)	2.0 (80)	17-18	190	1.7 (3.8)	1.3 (3.0)	79
		2.6 (105)	18-19	230	2.2 (5.3)	1.8 (4.0)	80
		3.0 (120)	19-20	245	2.5 (5.7)	2.0 (4.5)	79
		3.5 (140)	21-22	275	3.0 (6.8)	2.4 (5.5)	81
		4.4 (175)	21-22	295	3.6 (8.0)	2.9 (6.4)	80
5/64 in (2.0 mm), DC-	25 (1)	1.7 (70)	17-18	205	2.0 (4.5)	1.5 (3.4)	76
		2.0 (80)	18-19	225	2.3 (5.1)	1.7 (3.9)	76
		2.2 (90)	18-19	240	2.6 (5.8)	2.0 (4.5)	78
		2.7 (110)	20-21	275	3.1 (7.0)	2.4 (5.5)	79
		3.3 (130)	20-21	300	3.7 (8.3)	2.9 (6.5)	78

<sup>(1)</sup>Typical all weld metal. <sup>(2)</sup>Measured with 0.2% offset. <sup>(3)</sup>See test results disclaimer

# INNERSHIELD® NR®-208-H

Low Alloy, All Position ▪ AWS E91T8-G-H8, E91T8-AG-G-H8

## KEY FEATURES

- Designed to create high strength weld deposits
- Recommended for API grade X80
- High deposition rates

## TYPICAL APPLICATIONS

- Standard cross-country pipelines
- Undermatched X80 grade pipe

## CONFORMANCES

**AWS A5:** E91T8-AG-G-H8 E91T8-G-H8

## WELDING POSITIONS

All, except vertical up

## DIAMETERS / PACKAGING

Diameter in (mm)	14 lb (6.4 kg) Coil 56 lb (25.4 kg) Hermetically Sealed Pail
5/64 (2.0)	ED023366

## MECHANICAL PROPERTIES<sup>(1)</sup>

	Yield Strength <sup>(2)</sup> MPa (ksi)	Tensile Strength MPa (ksi)	Elongation %	Hardness Rockwell B	Charpy V-Notch J (ft•lbf) @ -29°C (-20°F)
<b>Requirements</b> - AWS E91T8-G-H8	540 (78) min	620-760 (90-110)	17 min	–	Not Specified
<b>Typical Results<sup>(3)</sup></b> - As-Welded	555-600 (81-87)	630-670 (91-97)	24-27	91-95	54-129 (40-95)

## DEPOSIT COMPOSITION<sup>(1)</sup>

	%C	%Mn	%Si	%S	%P	%Ni <sup>(4)</sup>
<b>Requirements</b> - AWS E91T8-G-H8	Not Specified	0.50 min	1.00 max	0.030 max	0.030 max	0.50 min
<b>Typical Results<sup>(3)</sup></b>	0.04-0.07	1.48-2.02	0.11-0.31	≤0.003	0.004-0.010	0.71-0.98
	%Cr <sup>(4)</sup>	%Mo <sup>(4)</sup>	%V <sup>(4)</sup>	%Al <sup>(4)</sup>	Diffusible Hydrogen (mL/100g weld metal)	
<b>Requirements</b> - AWS E91T8-G-H8	0.30 min	0.20 max	0.10 min	1.8 min	8.0 max	
<b>Typical Results<sup>(3)</sup></b>	0.02-0.03	≤0.04	≤0.01	0.9-1.2	≤8	

## TYPICAL OPERATING PROCEDURES

Diameter, Polarity	CTWD mm (in)	Wire Feed Speed m/min (in/min)	Voltage (volts)	Approx. Current (amps)	Melt-Off Rate kg/hr (lb/hr)	Deposition Rate kg/hr (lb/hr)	Efficiency (%)
5/64 in (2.0 mm), DC-	25 (1)	1.7 (70)	16-17	195	1.8 (4.0)	1.4 (3.2)	81
		2.0 (80)	17-18	220	2.1 (4.6)	1.7 (3.9)	84
		2.2 (90)	18-19	235	2.5 (5.4)	2.0 (4.5)	84
		2.7 (110)	19-20	270	2.9 (6.5)	2.4 (5.5)	85
		3.3 (130)	19-20	295	3.5 (7.6)	2.9 (6.5)	85

<sup>(1)</sup>Typical all weld metal. <sup>(2)</sup>Measured with 0.2% offset. <sup>(3)</sup>See test results disclaimer. <sup>(4)</sup>In order to meet the alloy requirements of the G group, the weld deposit needs to have the minimum, as specified in the table, of only one of the elements marked.

# INNERSHIELD® NR®-212

Low Alloy, All Position ▪ AWS E71TG-G, E71TG-AZ-G-H16

## KEY FEATURES

- Accommodates a wide range of mild steels
- Fast freeze characteristics accommodate poor fit-up
- Smooth arc performance and ease of use

## WELDING POSITIONS

All

## MAXIMUM PLATE THICKNESS

Diameter - in (mm)	Maximum Plate Thickness - in (mm)
0.045 (1.1)	3/4 (19.1)
0.068 (1.7)	3/4 (19.1)
5/64 (2.0)	3/4 (19.1)

## CONFORMANCES

<b>AWS A5:</b>	E71TG-AZ-G-H16, E71TG-G-H16
<b>CWB/CSA:</b>	E491TG-AZ-G-H16, E491TG-G-H16
<b>ISO:</b>	T49 Z T11-1 NO A-G H15

## TYPICAL APPLICATIONS

- Single or multiple pass welding on up to 19 mm (3/4 in) thicknesses
- General fabrication
- Robotics
- Truck bodies, tanks, hoppers, racks and scaffolding
- Welding on galvanized steel or zinc coated carbon steel

## DIAMETERS / PACKAGING

Diameter in (mm)	10 lb (4.5 kg) Plastic Spool	14 lb (6.4 kg) Coil 56 lb (25.4 kg) Master Carton	25 lb (11.3 kg) Steel Spool	50 lb (22.7 kg) Coil
0.045 (1.1)	ED026090		ED030639	
0.068 (1.7)		ED027803	ED030642	
5/64 (2.0)		ED027794	ED030646	ED026858

## MECHANICAL PROPERTIES<sup>(1)</sup>

	Yield Strength <sup>(2)</sup> MPa (ksi)	Tensile Strength MPa (ksi)	Elongation %	Hardness Rockwell B
<b>Requirements</b> - AWS E71TG-G	400 (58) min	480-655 (70-95)	20 min	–
<b>Typical Results</b> <sup>(3)</sup>	440-505 (64-74)	575-605 (84-88)	24-28	89-92

**DEPOSIT COMPOSITION<sup>(1)</sup>**

	%C	%Mn <sup>(4)</sup>	%Si	%S	%P
<b>Requirements - AWS E71TG-G</b>	Not Specified	0.50 min	1.00 max	0.030 max	0.030 max
<b>Typical Results<sup>(3)</sup></b>	0.06-0.11	0.84-1.55	0.20-0.33	≤0.003	0.006-0.009
	%Ni <sup>(4)</sup>	%Cr <sup>(4)</sup>	%Mo <sup>(4)</sup>	%V <sup>(4)</sup>	%Al
<b>Requirements - AWS E71TG-G</b>	0.50 min	0.30 min	0.20 min	0.10 min	1.8 max
<b>Typical Results<sup>(3)</sup></b>	1.02-1.15	0.02-0.04	≤0.02	–	1.3-1.6

**TYPICAL OPERATING PROCEDURES**

Diameter, Polarity	CTWD mm (in)	Wire Feed Speed m/min (in/min)	Voltage (volts)	Approx. Current (amps)	Melt-Off Rate kg/hr (lb/hr)	Deposition Rate kg/hr (lb/hr)	Efficiency (%)
0.045 in (1.1 mm), DC-	16 (5/8)	1.4 (55)	14-15	75	0.5 (1.3)	0.5 (1.1)	84
		1.8 (70)	15-16	90	0.7 (1.6)	0.6 (1.4)	87
		2.3 (90)	16-17	115	1.0 (2.1)	0.8 (1.8)	85
		2.8 (110)	17-18	135	1.2 (2.6)	1.0 (2.2)	84
		3.3 (130)	18-19	155	1.4 (3.1)	1.2 (2.6)	83
		4.1 (160)	19-20	170	1.6 (3.5)	1.4 (3.0)	85
0.068 in (1.7 mm), DC-	25 (1)	1.5 (60)	16-17	145	1.4 (3.1)	1.1 (2.4)	77
		1.9 (75)	17-18	180	1.7 (3.8)	1.4 (3.2)	84
		2.3 (90)	18-19	200	2.0 (4.5)	1.7 (3.8)	84
		3.0 (120)	19-20	230	2.7 (6.0)	2.3 (5.2)	86
		3.8 (150)	20-21	255	3.3 (7.4)	2.9 (6.4)	86
		4.4 (175)	22-23	275	3.9 (8.7)	3.4 (7.5)	86
5/64 in (2.0 mm), DC-	25 (1)	1.5 (60)	16-17	200	1.7 (3.8)	1.5 (3.3)	86
		1.9 (75)	18-19	225	2.1 (4.7)	1.8 (4.1)	87
		2.3 (90)	19-20	245	2.6 (5.7)	2.3 (5.0)	87
		2.8 (110)	20-21	275	3.2 (7.1)	2.8 (6.2)	87
		3.3 (130)	21-23	300	3.7 (8.3)	3.3 (7.3)	87
		3.8 (150)	22-23	325	4.3 (9.6)	3.8 (8.4)	87

<sup>(1)</sup>Typical all weld metal. <sup>(2)</sup>Measured with 0.2% offset. <sup>(3)</sup>See test results disclaimer <sup>(4)</sup>In order to meet the alloy AWS requirements of the G group, the weld deposit needs to have the minimum, as specified in the table, of only one of these elements.

# INNERSHIELD® NR®-440Ni2

Low Alloy, All Position ▪ AWS E71T8-Ni2-JH8, E71T8-A4-Ni2-H8

## KEY FEATURES

- Designed to provide optimal weldability in narrow TKY joints and poor fit up conditions
- Expect fast travel speeds and a flat bead face when using vertical-up or vertical-down welding techniques
- Low temperature impact toughness, meets ABS 4YSA and AWS J classification
- Meets H8 diffusible hydrogen requirements over a range of humidity levels
- ProTech® hermetically sealed packaging
- Q2 Lot® - Certificate showing actual deposit chemistry and mechanical properties per lot available online.

## CONFORMANCES

- AWS A5:** E71T8-A4-Ni2-H8, E71T8-Ni2-JH8
- ABS:** 4YSA H5
- DNV:** IV YMS H5
- Lloyd's Register:** 4YS H5
- ISO:** T49 4 T8-1 NO A-N5 H5

## TYPICAL APPLICATIONS

- Offshore

## WELDING POSITIONS

All

## DIAMETERS / PACKAGING

Diameter in (mm)	8 lb (3.6 kg) Spool 48 lb (21.8 kg) Hermetically Sealed Pail	14 lb (6.4 kg) Coil 56 lb (25.4 kg) Hermetically Sealed Pail
1/16 (1.6)	ED034365	ED034200
5/64 (2.0)	ED034195	ED033827

## MECHANICAL PROPERTIES<sup>(1)</sup>

	Yield Strength <sup>(2)</sup> MPa (ksi)	Tensile Strength MPa (ksi)	Elongation %	Charpy V-Notch J (ft·lbf) @-40°C (-40°F)
<b>Requirements<sup>(4)</sup> - AWS E71T8-Ni2-JH8</b>	400 (58) min	480-620 (70-90)	22 min	27 (20) min
<b>Typical Results<sup>(3)</sup></b>	400-485 (58-70)	490-570 (71-83)	22-36	215-460 (160-340)

**DEPOSIT COMPOSITION<sup>(1)</sup>**

	%C	%Mn	%Ni	%Si	%S	%P	%Al
<b>Requirements</b> AWS E71T8-Ni2-JH8	0.30 max	1.75 max	1.75-2.75	0.60 max	0.030 max	0.030 max	1.8 max
<b>Typical Results<sup>(3,4)</sup></b>	0.01-0.03	0.74-1.12	1.77-2.10	0.13-0.17	0.002-0.004	0.007-0.012	0.84-1.07

**TYPICAL OPERATING PROCEDURES**

Diameter, Polarity	CTWD mm (in)	Wire Feed Speed m/min (in/min)	Voltage (volts)	Approx. Current (amps)	Melt-Off Rate kg/hr (lb/hr)	Deposition Rate kg/hr (lb/hr)	Efficiency (%)
1.6 mm (1/16 in), DC-	22 (7/8)	2.3 (90)	17-18	160	1.6 (3.6)	1.1 (2.5)	69
		2.5 (100)	18-19	170	1.6 (3.6)	1.2 (2.8)	72
		2.8 (110)	18-19	180	2.0 (4.4)	1.4 (3.1)	73
		3.0 (120)	19-20	195	2.2 (4.8)	1.6 (3.5)	73
		3.3 (130)	19-20	210	2.3 (5.1)	1.7 (3.7)	73
2.0 mm (5/64 in), DC-	25 (1)	1.8 (70)	16-17	205	1.9 (4.2)	1.5 (3.2)	76
		2.0 (80)	17-18	225	2.2 (4.7)	1.6 (3.6)	77
		2.3 (90)	18-19	240	2.4 (5.3)	1.9 (4.2)	78
		2.5 (100)	19-20	260	2.7 (5.9)	2.1 (4.7)	79
		2.8 (110)	20-21	260	3.0 (6.5)	2.4 (5.2)	80
		3.0 (120)	20-21	295	3.2 (7.1)	2.5 (5.6)	79

<sup>(1)</sup>Typical all weld metal. <sup>(2)</sup>Measured with 0.2% offset. <sup>(3)</sup>See test results disclaimer. <sup>(4)</sup>The strength and elongation properties reported were obtained from a 2.8 mm (0.505 in) tensile specimen artificially aged at 104 °C (220 °F) for 48 hours, as permitted by AWS A5.20-05. A naturally aged tensile specimen may take months to achieve the specified properties. See AWS A5.20-05, paragraph A8.3. The time required for the natural aging of weld deposits is dependent upon ambient conditions, weldment geometry, the metallurgical structure of the weld deposit and other factors.



# INNERSHIELD® NR®-555

Low Alloy, All Position ▪ AWS E81T8-G, E81T8-A5-K8-H8

## KEY FEATURES

- Self-shielded electrode designed for welding in structural applications
- Welder friendly operability and flat bead face in out-of-position fillets and groove welds
- Meets AWS D1.8 seismic lot waiver requirements
- ProTech® foil bag packaging shields against moisture, prevents rust and prolongs storage life

## WELDING POSITIONS

All

## CONFORMANCES

- AWS A5:** E81T8-A5-K8-H8, E81T8-G  
**CWB/CSA:** E551T8-G, E81T8-G  
**AWS D1.8:** 1/16", 5/64"  
**ISO:** T46 5 Z Y NO 1 H10, T55 5 T8-1 NO A-G H10

## TYPICAL INDUSTRY SEGMENTS

- Structural
- General Fabrication

## DIAMETERS / PACKAGING

Diameters in (mm)	25 lb (11.3 kg) Plastic Spool
1/16 (1.6)	ED035565
5/64 (2.0)	ED035566

## MECHANICAL PROPERTIES<sup>(1)</sup>

	Yield Strength <sup>(2)</sup> MPa (ksi)	Tensile Strength MPa (ksi)	Elongation (%)	Charpy V-Notch J (ft·lbf)		
				-46°C (-50°F)	-29°C (-20°F)	21°C (70°F)
<b>Requirements</b> AWS A5.29: E81T8-G	470 (68) min	550-690 (80-100) min	19	-	-	-
AWS A5.36: E81T8-A5-K8-H8		550 (80) min		27 (20) min	-	-
AWS D1.8: 80 ksi Classification		550 (80) min		-	54 (40) min	54 (40) min
<b>Typical Results<sup>(3)</sup></b> AWS A5.36	550 (80)	630 (91)	25	100 (74)	-	-
AWS D1.8 High Heat Input (80 kJ/in)	490 (70)	615 (88)	26	-	64 (47)	143 (105)
AWS D1.8 Low Heat Input (30 kJ/in)	580 (84)	650 (93)	24	-	108 (80)	172 (127)

**DEPOSIT COMPOSITION<sup>(1)</sup>**

	%C	%Mn	%Si	%S	%P	%Ni
<b>Requirements</b> AWS A5.29: E81T8-G	0.15 max	1.00-2.00	0.40 max	0.030 max	0.030 max	0.50-1.50
AWS A5.36: E81T8-A5-K8-H8						
<b>Typical Results<sup>(3)</sup></b>	0.05	1.84	0.17	0.001	0.011	1.12
	%Cr	%Mo	%V	%Al	Diffusible Hydrogen (mL/100g weld deposit)	
<b>Requirements</b> AWS A5.29: E81T8-G	0.20 max	0.20 max	0.05 max	1.80 max	-	
AWS A5.36: E81T8-A5-K8-H8					8 max	
<b>Typical Results<sup>(3)</sup></b>	0.05	0.01	0.00	0.84	5	

**TYPICAL OPERATING PROCEDURES**

Diameter, Polarity Shielding Gas	CTWD <sup>(4)</sup> mm (in)	Wire Feed Speed m/min (in/min)	Voltage (volts)	Approx. Current (amps)	Melt-Off Rate kg/hr (lb/hr)	Deposition Rate kg/hr (lb/hr)	Efficiency (%)
1/16 in (1.6 mm), DC- Optimal Settings	22 (7/8)	2.8 (110)	19	185	2.0 (4.5)	1.5 (3.4)	77%
Min - Max	22 (7/8)	1.8-3.0 (75-120)	16-20	145-200	1.4-2.2 (3.0-4.9)	1.0-1.6 (2.2-3.6)	72-77%
5/64 in (2.0 mm), DC- Optimal Settings	22 (7/8)	2.8 (110)	19	245	2.9 (6.5)	2.5 (5.5)	85%
Min - Max	22 (7/8)	1.8-3.0 (75-120)	16-21	185-260	1.9-3.2 (4.1-7.1)	1.4-2.6 (3.0-5.8)	74-85%

<sup>(1)</sup>Typical all weld metal. <sup>(2)</sup>Measure with 0.2% offset. <sup>(3)</sup>See test results disclaimer <sup>(4)</sup>To estimate ESO, subtract 1/4 in. (6.0 mm) from CTWD.

# ULTRACORE® 360™ C71

Mild Steel, All Position ■ AWS E71T-9C-JH4, E81T1-GC-H4, E71T1-C1A6-CS1-H4

## KEY FEATURES

- Seamless design protects the flux core from environmental exposure helping to maintain low diffusible hydrogen and extend shelf life
- Copper coating offers superior feedability and extended contact tip life
- Low spatter and fume levels for less post-weld clean up and a better work environment
- Low H4 diffusible hydrogen levels minimize the risk of hydrogen induced cracking
- Premium arc performance and bead appearance

## WELDING POSITIONS

All

## CONFORMANCES

- AWS A5:** E71T1-C1A4-CS1-H4, E71T-1C-JH4  
**ABS:** 4Y400400  
**CWB/CSA:** E491T1-C1A4-CS1-H4 (E491T-9J-H4)  
**Lloyd's Register:** 4Y40S H5  
**AWS D1.8:** 0.045", 0.052", 1/16"

## TYPICAL APPLICATIONS

- Offshore
- Shipbuilding
- Structural
- General Fabrication

## SHIELDING GAS

100% CO<sub>2</sub>  
 Flow rate: 35 CFH

## DIAMETERS / PACKAGING

Diameter in (mm)	27 lb (12.2kg) Plastic Spool
0.045 (1.1)	ED036167
0.052 (1.3)	ED036168
1/16 (1.6)	ED036169

## MECHANICAL PROPERTIES<sup>(1)</sup>

	Yield Strength <sup>(2)</sup> MPa (ksi)	Tensile Strength MPa (ksi)	Elongation %	Charpy V-Notch J (ft•lbf)	
				@ -40°C (-40°F)	@ -51°C (-60°F)
<b>Requirements</b>					
AWS A5.20: E71T-9C-JH4	390 (58) min	490-670 (70-95)	22 min	27 (20) min	-
AWS A5.29: E81T1-GC-H4	470 (68) min	550-690 (80-100)	19 min	-	-
AWS A5.36: E71T1-C1A6-CS1-H4	400 (58) min	490-660 (70-95)	22 min	-	27 (20) min
<b>Typical Results<sup>(3)</sup></b>					
As-Welded with 100% CO <sub>2</sub>	510-600 (74-87)	590-650 (85-94)	24-29	60-155 (44-114)	62-137 (46-101)

<sup>(1)</sup>Typical all weld metal. <sup>(2)</sup>Measured with 0.2% offset. <sup>(3)</sup>See test results disclaimer

**DEPOSIT COMPOSITION<sup>(1)</sup>**

	%C	%Mn	%Si	%S	%P	%Ni
<b>Requirements</b>						
AWS A5.20: E71T-9C-JH4	0.12 max	1.75 max	0.90 max	0.03 max	0.03 max	0.50 max
AWS A5.29: E81T1-GC-H4	Not Specified	0.50 <sup>(4)</sup>	1.00 max	0.030 max	0.030 max	0.50 <sup>(4)</sup>
AWS A5.36: E71T1-C1A6-CS1-H4	0.12 max	1.75 max	0.90 max	0.030 max	0.030 max	0.50 max
<b>Typical Results<sup>(3)</sup></b>						
As-Welded with 100% CO <sub>2</sub>	0.04-0.08	1.19-1.41	0.37-0.47	0.003-0.005	0.012-0.013	0.35-0.38
	%Cr	%Mo	%V	%Cu	%B	Diffusible Hydrogen (mL/100g weld deposit)
<b>Requirements</b>						
AWS A5.20: E71T-9C-JH4	0.20 max	0.30 max	0.08 max	0.35 max	Not Specified	4.0 max
AWS A5.29: E81T1-GC-H4	0.30 <sup>(4)</sup>	0.20 <sup>(4)</sup>	0.10 <sup>(4)</sup>	Not Specified		
AWS A5.36: E71T1-C1A6-CS1-H4	0.20 max	0.30 max	0.08 max	0.35 max		4 max
<b>Typical Results<sup>(3)</sup></b>						
As-Welded with 100% CO <sub>2</sub>	0.02-0.03	0.00-0.01	0.01	0.23-0.28	0.003-0.004	1-4

**TYPICAL OPERATING PROCEDURES**

Diameter, Polarity Shielding Gas	CTWD <sup>(5)</sup> mm (in)	Wire Feed Speed m/min (in/min)	Voltage (volts)	Approx. Current (amps)	Melt-Off Rate kg/hr (lb/hr)	Deposition Rate kg/hr (lb/hr)	Efficiency (%)
0.045 in (1.1 mm), DC+ 100% CO <sub>2</sub>	25 (1)	6.4 (250)	24-29	175	2.7 (5.9)	2.4 (5.3)	88-93
		7.6 (300)	25-30	200	3.2 (7.0)	2.9 (6.4)	
		8.9 (350)	26-32	225	3.7 (8.2)	3.4 (7.5)	
		10.2 (400)	27-33	245	4.3 (9.4)	3.9 (8.6)	
		11.4 (450)	27-35	265	4.8 (10.6)	4.4 (9.7)	
		12.7 (500)	28-36	290	5.3 (11.7)	4.9 (10.9)	
0.052 in (1.3 mm), DC+ 100% CO <sub>2</sub>	25 (1)	5.1 (200)	23-27	200	2.8 (6.2)	2.6 (5.7)	91-93
		6.4 (250)	25-28	235	3.5 (7.7)	3.2 (7.1)	
		8.9 (350)	27-31	300	4.9 (10.8)	4.5 (10.0)	
		10.8 (425)	28-32	335	6.0 (13.1)	5.5 (12.1)	
		12.7 (500)	30-34	375	7.0 (15.4)	6.5 (14.2)	
1/16 in (1.6 mm), DC+ 100% CO <sub>2</sub>	25 (1)	3.8 (150)	23-27	230	3.1 (6.7)	2.8 (6.1)	92-96
		5.1 (200)	24-28	275	4.1 (9.0)	3.8 (8.4)	
		6.4 (250)	25-31	310	5.1 (11.3)	4.8 (10.6)	
		7.6 (300)	27-34	370	6.1 (13.5)	5.8 (12.8)	
		8.9 (350)	29-36	410	7.2 (15.8)	6.8 (15.0)	

<sup>(1)</sup>Typical all weld metal. <sup>(3)</sup>See test results disclaimer. <sup>(4)</sup>In order to meet the requirements of the G group, the undiluted weld metal shall have not less than the minimum specified for one or more of the elements listed. <sup>(5)</sup>To estimate ESO, subtract 1/4 in (6.0 mm) from CTWD. NOTE: This product contains micro-alloying elements. Additional information available upon request

# ULTRACORE® 360™ M71

Mild Steel, All Position ■ E71T-1M-JH4, E71T-1C-H4, E71T1-M21A2-CS1-H4, E71T1-C1A0-CS1-H4

## KEY FEATURES

- Seamless design protects the flux core from environmental exposure helping to maintain low diffusible hydrogen and extend shelf life
- Copper coating offers superior feedability and extended contact tip life
- Low spatter and fume levels for less post-weld clean up and a better work environment
- Low H4 diffusible hydrogen levels minimize the risk of hydrogen induced cracking
- Premium arc performance and bead appearance

## WELDING POSITIONS

All

## CONFORMANCES

- AWS A5:** E71T1-C1A0-CS1-H4, E71T1-M21A4-CS1-H4  
E71T-1C-H4, E71T-1M-JH4
- ABS:** 3YSA H5
- CWB/CSA:** E491T1-M21A4-CS1-H4 (E491T-9MJ-H4)
- Lloyd's Register:** 3Y40S H5
- AWS D1.8:** 0.045", 0.052", 1/16"

## TYPICAL APPLICATIONS

- Offshore
- Shipbuilding
- Structural
- Oil & Gas

## SHIELDING GAS

80% Ar / 20% CO<sub>2</sub>  
100% CO<sub>2</sub>  
Flow rate: 35 CFH

## DIAMETERS / PACKAGING

Diameter in (mm)	33 lb (15 kg) Plastic Spool
0.045 (1.1)	W000403768
0.052 (1.3)	W000403769
1/16 (1.6)	W000403770

## MECHANICAL PROPERTIES<sup>(1)</sup>

	Yield Strength <sup>(2)</sup> MPa (ksi)	Tensile Strength MPa (ksi)	Elongation %	Charpy V-Notch J (ft·lbf)		
				-18°C (0°F)	-29°C (-20°F)	-40°C (-40°F)
<b>Requirements</b>						
AWS A5.20: E71T-1M-JH4	400 (58) min	490-660 (70-95)	22 min	-	-	27 (20) min
AWS A5.20: E71T-1C-H4				27 (20) min	-	-
AWS A5.36: E71T1-M21A2-CS1-H4				-	27 (20) min	-
AWS A5.36: E71T1-C1A0-CS1-H4				27 (20) min	-	-
<b>Typical Results<sup>(3)</sup></b>						
As-Welded with 80% Ar/ 20% CO <sub>2</sub>	500-540 (72-79)	560-620 (81-90)	24-28	70-100 (51-74)	80-120 (59-90)	35-55 (25-41)
As-Welded with 100% CO <sub>2</sub>	470 (68)	530 (77)	28	60 (44)	-	-

<sup>(1)</sup>Typical all weld metal. <sup>(2)</sup>Measured with 0.2% offset. <sup>(3)</sup>See test results disclaimer

**DEPOSIT COMPOSITION<sup>(1)</sup>**

	%C	%Mn	%Si	%S
<b>Requirements</b>				
AWS A5.20: E71T-1M-JH4, E71T-1C-H4	0.12 max	1.75 max	0.90 max	0.03 max
AWS A5.36: E71T1-M21A2-CS1-H4, E71T-C1A0-CS1-H4	0.12 max	1.75 max	0.90 max	0.030 max
<b>Typical Results<sup>(3)</sup></b>				
As-Welded with 80% Ar / 20% CO <sub>2</sub>	0.04-0.06	1.20-1.50	0.40-0.50	< 0.015
	%P	%Cu	%B	Diffusible Hydrogen (mL/100g weld deposit)
<b>Requirements</b>				
AWS A5.20: E71T-1M-JH4, E71T-1C-H4	0.03 max	0.35 max	Not Specified	4.0 max
AWS A5.36: E71T1-M21A2-CS1-H4, E71T-C1A0-CS1-H4	0.030 max	0.35 max	Not Specified	4 max
<b>Typical Results<sup>(3)</sup></b>				
As-Welded with 80% Ar / 20% CO <sub>2</sub>	< 0.015	0.10-0.20	0.003-0.006	1.5-3.5

**TYPICAL OPERATING PROCEDURES**

Diameter, Polarity Shielding Gas	CTWD <sup>(5)</sup> mm (in)	Wire Feed Speed m/min (in/min)	Voltage (volts)	Approx. Current (amps)	Melt-Off Rate kg/hr (lb/hr)	Deposition Rate kg/hr (lb/hr)	Efficiency (%)
0.045 in (1.1 mm), DC+ 80% Ar / 20% CO <sub>2</sub>	15-20 (3/4)	6.0 (236)	21-23	160	2.5 (5.5)	2.2 (4.8)	85-88
		7.5 (295)	23-24	190	3.1 (6.9)	2.7 (6.0)	
		9.0 (354)	24-26	220	3.8 (8.3)	3.3 (7.3)	
		10.5 (413)	26-28	250	4.4 (9.7)	3.9 (8.6)	
		11.5 (453)	27-29	260	4.8 (10.6)	4.3 (9.4)	
		13.0 (512)	28-30	270	5.4 (12.0)	4.8 (10.7)	
0.052 in (1.3 mm), DC+ 80% Ar / 20% CO <sub>2</sub>	15-20 (3/4)	5.0 (197)	21-22	210	2.7 (6.1)	2.4 (5.3)	85-88
		6.0 (236)	23-24	240	3.3 (7.3)	2.9 (6.3)	
		8.0 (315)	26-27	280	4.4 (9.7)	3.9 (8.5)	
		9.0 (354)	27-29	300	4.9 (10.9)	4.4 (9.7)	
		10.0 (394)	27-29	320	5.5 (12.1)	4.9 (10.8)	
1/16 in (1.6 mm), DC+ 80% Ar / 20% CO <sub>2</sub>	15-20 (3/4)	3.1 (122)	21-22	190	2.4 (5.3)	2.1 (4.6)	85-88
		5.0 (197)	23-26	280	3.9 (8.6)	3.4 (7.6)	
		6.5 (256)	26-28	350	5.1 (11.2)	4.5 (10.0)	
		7.5 (295)	27-29	370	5.9 (12.9)	5.2 (11.5)	
		9.0 (354)	28-30	400	7.0 (15.5)	6.3 (13.8)	

<sup>(1)</sup>Typical all weld metal. <sup>(2)</sup>See test results disclaimer. <sup>(3)</sup>In order to meet the requirements of the G group, the undiluted weld metal shall have not less than the minimum specified for one or more of the elements listed. <sup>(4)</sup>To estimate ESO, subtract 1/4 in (6.0 mm) from CTWD. NOTE: This product contains micro-alloying elements. Additional information available upon request.

# ULTRACORE® 71A75 DUAL

Mild Steel, All Position ■ AWS E71T-9C-H8, E71T-9M-H8, E71T1-C1A2-CS1-H8, E71T1-M21A2-CS1-H8

## KEY FEATURES

- Designed for welding with either 100% CO<sub>2</sub> or 75% Argon/25% CO<sub>2</sub> shielding gases
- Premium arc performance and bead appearance
- ProTech® foil bag packaging

## WELDING POSITIONS

All

## SHIELDING GAS

100% CO<sub>2</sub>  
75% Argon / 25% CO<sub>2</sub>  
Flow Rate: 40 - 50 CFH

## CONFORMANCES

**AWS A5:** E71T1-C1A2-CS1-H8,  
E71T1-M21A2-CS1-H8, E71T-1C-H8  
E71T-1M-H8, E71T-9C-H8, E71T-9M-H8

**CWB/CSA:** E491T-9-H8, E491T-9M-H8

**ISO:** T49 3 T1-1 C1 A H10, T49 3 T1-1 M21 A H10

## TYPICAL APPLICATIONS

- General fabrication

## DIAMETERS / PACKAGING

Diameter in (mm)	15 lb (6.8 kg) Plastic Spool 60 lb (27.2 kg) Master Carton	33 lb (15 kg) Spool*	50 lb (22.7 kg) Fiber Spool	500 lb (227 kg) Accu-Trak® Drum
0.045 (1.1)	ED031882	ED031669	ED031844	ED032044
0.052 (1.3)	ED031883	ED031670	ED031845	ED032045
1/16 (1.6)	ED031884	ED031671	ED031846	ED032046

\*Spool may be plastic or fiber.

## MECHANICAL PROPERTIES<sup>(1)</sup>

	Yield Strength <sup>(2)</sup> MPa (ksi)	Tensile Strength MPa (ksi)	Elongation %	Charpy V-Notch J (ft•lbf)	
				@ -18°C (0°F)	@ -29°C (-20°F)
<b>Requirements<sup>(4)</sup></b> AWS E71T-1C-H8, E71T-1M-H8 AWS E71T-9C-H8, E71T-9M-H8	400 (58) min	480-655 (70-95)	22 min	27 (20) min Not Specified	Not Specified 27 (20) min
<b>Typical Results<sup>(3)</sup></b> As-Welded with 100% CO <sub>2</sub> As-Welded with 75% Ar/25% CO <sub>2</sub>	510-550 (73-79) 570-610 (82-88)	570-600 (82-87) 620-660 (89-95)	26-28 24-26	38-95 (28-70) 62-111 (46-82)	27-65 (20-48) 39-85 (29-63)

**DEPOSIT COMPOSITION<sup>(1)</sup>**

	%C	%Mn	%Si	%S	%P	Diffusible Hydrogen (mL/100g weld deposit)
<b>Requirements<sup>(4)</sup></b> AWS E71T-1C-H8, E71T-1M-H8 AWS E71T-9C-H8, E71T-9M-H8	0.12 max	1.75 max	0.90 max	0.03 max	0.03 max	8.0 max
<b>Typical Results<sup>(3)</sup></b> As-Welded with 100% CO <sub>2</sub> As-Welded with 75% Ar/25% CO <sub>2</sub>	0.03-0.04 0.03-0.04	1.28-1.41 1.45-1.60	0.42-0.49 0.54-0.62	0.01 0.01	0.01-0.02 0.01-0.02	3-8 4-8

**TYPICAL OPERATING PROCEDURES**

Diameter, Polarity Shielding Gas <sup>(5)</sup>	CTWD <sup>(6)</sup> mm (in)	Wire Feed Speed m/min (in/min)	Voltage (volts)	Approx. Current (amps)	Melt-Off Rate kg/hr (lb/hr)	Deposition Rate kg/hr (lb/hr)	Efficiency (%)
0.045 in (1.1 mm), DC+ 75% Ar/25% CO <sub>2</sub>	25 (1)	4.4 (175)	20-25	135	1.8 (4.0)	1.6 (3.5)	86-88
		6.4 (250)	21-26	150	2.6 (5.7)	2.3 (5.0)	
		7.6 (300)	22-27	165	3.1 (6.8)	2.7 (6.0)	
		8.9 (350)	23-28	190	3.6 (8.0)	3.2 (7.0)	
		10.2 (400)	24-29	205	4.1 (9.1)	3.6 (8.0)	
		11.4 (450)	25-30	225	4.7 (10.3)	4.1 (9.0)	
		12.7 (500)	26-31	245	5.2 (11.4)	4.5 (10.0)	
		14.0 (550)	27-32	265	5.7 (12.5)	5.0 (10.9)	
0.052 in (1.3 mm), DC+ 75% Ar/25% CO <sub>2</sub>	25 (1)	3.8 (150)	20-25	155	2.0 (4.5)	1.8 (3.9)	86-88
		5.1 (200)	21-26	165	2.7 (6.0)	2.4 (5.2)	
		6.4 (250)	22-27	190	3.4 (7.5)	2.9 (6.5)	
		7.6 (300)	23-28	215	4.1 (9.0)	3.5 (7.8)	
		8.9 (350)	24-29	235	4.7 (10.5)	4.1 (9.1)	
		9.5 (375)	25-30	255	5.1 (11.2)	4.4 (9.8)	
		10.8 (425)	27-31	275	5.8 (12.7)	5.0 (11.1)	
		12.1 (475)	28-33	295	6.4 (14.2)	5.6 (12.4)	
1/16 in (1.6 mm), DC+ 75% Ar/25% CO <sub>2</sub>	25 (1)	3.2 (125)	20-25	195	2.4 (5.3)	2.1 (4.6)	86-88
		4.4 (175)	21-26	215	3.3 (7.4)	2.9 (6.4)	
		5.1 (200)	22-27	235	3.8 (8.4)	3.3 (7.3)	
		5.7 (225)	23-28	265	4.3 (9.5)	3.7 (8.2)	
		6.4 (250)	24-29	285	4.8 (10.5)	4.2 (9.2)	
		7.6 (300)	25-31	315	5.7 (12.6)	5.0 (11.0)	
		8.3 (325)	25-32	335	6.2 (13.7)	5.4 (11.9)	
		8.9 (350)	26-33	365	6.7 (14.7)	5.8 (12.8)	
10.2 (400)	28-35	405	7.6 (16.8)	6.6 (14.6)			

<sup>(1)</sup>Typical all weld metal. <sup>(2)</sup>Measured with 0.2% offset. <sup>(3)</sup>See test results disclaimer <sup>(4)</sup>As-Welded with 100% CO<sub>2</sub> & As-Welded 75% Argon / 25% CO<sub>2</sub> <sup>(5)</sup>When welding under CO<sub>2</sub>, increase voltage by 1 Volt. <sup>(6)</sup>To estimate ESO, subtract 1/4 in (6.0 mm) from CTWD. NOTE: This product contains micro-alloying elements. Additional information available upon request



# ULTRACORE® 71A85

Mild Steel, All Position ■ AWS E71T-9M-H8, E71T1-M21A2-CS1-H8



## KEY FEATURES

- Designed for welding with 75 - 85% Argon/balance CO<sub>2</sub> shielding gas
- Premium arc performance and bead appearance
- Meets AWS D1.8 seismic lot waiver requirements
- ProTech® foil bag packaging

## WELDING POSITIONS

All

## SHIELDING GAS

75% - 85% Argon / Balance CO<sub>2</sub>  
Flow Rate: 40 - 50 CFH

## CONFORMANCES

<b>AWS A5:</b>	E71T1-M21A2-CS1-H8, E71T-1M-H8, E71T-9M-H8
<b>ABS:</b>	3YSA H10
<b>CWB/CSA:</b>	E491T-9M-H8
<b>DNV:</b>	III YMS H10
<b>Lloyd's Register:</b>	3YS H10
<b>AWS D1.8:</b>	0.045", 0.052", 1/16"
<b>ISO:</b>	T49 3 T1-1 M21 A H10

## TYPICAL APPLICATIONS

- Shipbuilding
- Seismic structural fabrication
- General fabrication

## DIAMETERS / PACKAGING

Diameter in (mm)	15 lb (6.8 kg) Plastic Spool 60 lb (27.2 kg) Master Carton	33 lb (15 kg) Spool**	50 lb (22.7 kg) Fiber Spool	500 lb (227 kg) Accu-Trak® Drum
0.045 (1.1)	ED031885	ED031663, ED035592*	ED031847	ED032047
0.052 (1.3)	ED031886	ED031664, ED035591*	ED031848	ED032048
1/16 (1.6)	ED031887	ED031665, ED035590*	ED031849	ED032049

\*Buy America Product \*\*Spool may be plastic or fiber.

## MECHANICAL PROPERTIES<sup>(1)</sup>

	Yield Strength <sup>(2)</sup> MPa (ksi)	Tensile Strength MPa (ksi)	Elongation %	Charpy V-Notch J (ft-lbf)	
				@ -18°C (0°F)	@ -29°C (-20°F)
<b>Requirements<sup>(4)</sup></b> AWS E71T-1M AWS E71T-9M	400 (58) min	480-655 (70-95)	22 min	27 (20) min Not Specified	Not Specified 27 (20) min
<b>Typical Results<sup>(3)</sup></b> As-Welded with 75%-85% Ar/balance CO <sub>2</sub>	550-600 (80-88)	600-650 (87-94)	24 - 26	64-115 (47-85)	43-95 (32-70)

**DEPOSIT COMPOSITION<sup>(1)</sup>**

	%C	%Mn	%Si	%S	%P	Diffusible Hydrogen (mL/100g weld deposit)
<b>Requirements<sup>(4)</sup></b> AWS E71T-1M, E71T-9M	0.12 max	1.75 max	0.90 max	0.03 max	0.03 max	8.0 max
<b>Typical Results<sup>(3)</sup></b> As-Welded with 75%-85% Ar/balance CO <sub>2</sub>	0.03-0.04	1.43-1.56	0.52-0.59	<0.01	0.01	6-8

**TYPICAL OPERATING PROCEDURES**

Diameter, Polarity Shielding Gas	CTWD <sup>(5)</sup> mm (in)	Wire Feed Speed m/min (in/min)	Voltage (volts)	Approx. Current (amps)	Melt-Off Rate kg/hr (lb/hr)	Deposition Rate kg/hr (lb/hr)	Efficiency (%)
0.045 in (1.1 mm), DC+ 75%-85% Ar/ balance CO <sub>2</sub>	25 (1)	4.4 (175)	21-26	125	1.8 (4.0)	1.6 (3.5)	86-88
		6.4 (250)	22-27	150	2.6 (5.7)	2.3 (5.0)	
		7.6 (300)	23-28	165	3.1 (6.8)	2.7 (6.0)	
		8.9 (350)	23-29	190	3.6 (8.0)	3.2 (7.0)	
		10.2 (400)	25-30	205	4.1 (9.1)	3.6 (8.0)	
		11.4 (450)	26-31	225	4.7 (10.3)	4.1 (9.0)	
		12.7 (500)	27-32	245	5.2 (11.4)	4.5 (10.0)	
		14.0 (550)	28-33	265	5.7 (12.5)	5.0 (10.9)	
0.052 in (1.3 mm), DC+ 75%-85% Ar/ balance CO <sub>2</sub>	25 (1)	3.8 (150)	21-26	150	2.0 (4.5)	1.8 (3.9)	86-88
		5.1 (200)	21-27	165	2.7 (6.0)	2.4 (5.2)	
		6.4 (250)	22-27	190	3.4 (7.5)	2.9 (6.5)	
		7.6 (300)	23-28	215	4.1 (9.0)	3.5 (7.8)	
		8.9 (350)	24-29	235	4.7 (10.5)	4.1 (9.1)	
		9.5 (375)	25-30	255	5.1 (11.2)	4.4 (9.8)	
		10.8 (425)	26-31	275	5.8 (12.7)	5.0 (11.1)	
		12.1 (475)	27-32	295	6.4 (14.2)	5.6 (12.4)	
1/16 in (1.6 mm), DC+ 75%-85% Ar/ balance CO <sub>2</sub>	25 (1)	3.2 (125)	20-25	185	2.4 (5.3)	2.1 (4.6)	86-88
		4.4 (175)	21-26	215	3.3 (7.4)	2.9 (6.4)	
		5.1 (200)	22-27	235	3.8 (8.4)	3.3 (7.3)	
		5.7 (225)	23-28	265	4.3 (9.5)	3.7 (8.2)	
		6.4 (250)	24-29	285	4.8 (10.5)	4.2 (9.2)	
		7.6 (300)	25-30	315	5.7 (12.6)	5.0 (11.0)	
		8.3 (325)	26-31	335	6.2 (13.7)	5.4 (11.9)	
		8.9 (350)	27-32	365	6.7 (14.7)	5.8 (12.8)	
10.2 (400)	28-33	385	7.6 (16.8)	6.6 (14.6)			

<sup>(1)</sup>Typical all weld metal. <sup>(2)</sup>Measured with 0.2% offset. <sup>(3)</sup>See test results disclaimer. <sup>(4)</sup>As-Welded with 75%-85% Argon/Balance CO<sub>2</sub>. <sup>(5)</sup>To estimate ESQ, subtract 1/4 in (6.0 mm) from CTWD.  
NOTE 1: FEMA and AWS D1.8 structural steel seismic supplement test data can be found on this product at [www.lincolnelectric.com](http://www.lincolnelectric.com). NOTE 2: This product contains micro-alloying elements.  
Additional information available upon request.

# ULTRACORE® 71C

Mild Steel, All Position ■ AWS E71T-9C-H8, E71T1-C1A2-CS1-H8



## KEY FEATURES

- Designed for welding with 100% CO<sub>2</sub> shielding gas
- Premium arc performance and bead appearance
- Meets AWS D1.8 seismic lot waiver requirements
- ProTech® foil bag packaging

## WELDING POSITIONS

All

## SHIELDING GAS

100% CO<sub>2</sub>  
Flow Rate: 40 - 50 CFH

## CONFORMANCES

- AWS A5:** E71T1-C1A2-CS1-H8, E71T-1C-H8, E71T-9C-H8
- ABS:** E71T-9C-H8
- CWB/CSA:** E491T1-C1A3-CS1-H8, E491T-9-H8
- DNV:** III YMS H10
- Lloyd's Register:** 3YS H10
- AWS D1.8:** 0.045", 0.052", 1/16"
- ISO:** T49 3 T1-1 C1 A H10

## TYPICAL APPLICATIONS

- Shipbuilding
- Seismic structural fabrication
- General fabrication
- Barge and railcar fabrication

## DIAMETERS / PACKAGING

Diameter in (mm)	15 lb (6.8 kg) Plastic Spool 60 lb (27.2 kg) Master Carton	33 lb (15 kg) Spool**	50 lb (22.7 kg) Fiber Spool	500 lb (227 kg) Accu-Trak® Drum
0.045 (1.1)	ED031818	ED031666, ED033872*	ED031822	ED031876
0.052 (1.3)	ED031819	ED031667, ED033873*	ED031823	ED031877
1/16 (1.6)	ED031820	ED031668, ED033874*	ED031824, ED034410*	ED031878

\*Buy America Product \*\*Spool may be plastic or fiber.

## MECHANICAL PROPERTIES<sup>(1)</sup>

	Yield Strength <sup>(2)</sup> MPa (ksi)	Tensile Strength MPa (ksi)	Elongation %	Charpy V-Notch J (ft·lbf)	
				@ -18°C (0°F)	@ -29°C (-20°F)
<b>Requirements<sup>(4)</sup></b> AWS E71T-1C-H8 AWS E71T-9C-H8	400 (58) min	480-655 (70-95)	22 min	27 (20) min Not Specified	Not Specified 27 (20) min
<b>Typical Results<sup>(3)</sup></b> As-Welded with 100% CO <sub>2</sub>	515-560 (74-81)	570-605 (82-87)	25-27	56-115 (41-85)	34-72 (25-53)

**DEPOSIT COMPOSITION<sup>(1)</sup>**

	%C	%Mn	%Si	%S	%P	Diffusible Hydrogen (mL/100g weld deposit)
<b>Requirements<sup>(4)</sup></b> AWS E71T-1C-H8 AWS E71T-9C-H8	0.12 max	1.75 max	0.90 max	0.03 max	0.03 max	8.0 max
<b>Typical Results<sup>(3)</sup></b> As-Welded with 100% CO <sub>2</sub>	0.03-0.04	1.31-1.41	0.43-0.49	0.01	0.01	4-7

**TYPICAL OPERATING PROCEDURES**

Diameter, Polarity Shielding Gas	CTWD <sup>(5)</sup> mm (in)	Wire Feed Speed m/min (in/min)	Voltage (volts)	Approx. Current (amps)	Melt-Off Rate kg/hr (lb/hr)	Deposition Rate kg/hr (lb/hr)	Efficiency (%)
0.045 in (1.1 mm), DC+ 100% CO <sub>2</sub>	25 (1)	4.4 (175)	21-26	125	1.8 (4.0)	1.6 (3.5)	86-88
		6.4 (250)	22-27	155	2.6 (5.7)	2.3 (5.0)	
		7.6 (300)	23-28	165	3.1 (6.8)	2.7 (6.0)	
		8.9 (350)	24-29	190	3.6 (8.0)	3.2 (7.0)	
		10.2 (400)	25-30	205	4.1 (9.1)	3.6 (8.0)	
		11.4 (450)	26-31	230	4.7 (10.3)	4.1 (9.0)	
		12.7 (500)	27-32	245	5.2 (11.4)	4.5 (10.0)	
		14.0 (550)	28-33	265	5.7 (12.5)	5.0 (10.9)	
0.052 in (1.3 mm), DC+ 100% CO <sub>2</sub>	25 (1)	3.8 (150)	21-26	150	2.0 (4.5)	1.8 (3.9)	86-88
		5.1 (200)	22-27	165	2.7 (6.0)	2.4 (5.2)	
		6.4 (250)	23-28	190	3.4 (7.5)	2.9 (6.5)	
		7.6 (300)	24-29	215	4.1 (9.0)	3.5 (7.8)	
		8.9 (350)	25-30	235	4.7 (10.5)	4.1 (9.1)	
		9.5 (375)	26-31	255	5.1 (11.2)	4.4 (9.8)	
		10.8 (425)	28-33	275	5.8 (12.7)	5.0 (11.1)	
		12.1 (475)	29-34	295	6.4 (14.2)	5.6 (12.4)	
1/16 in (1.6 mm), DC+ 100% CO <sub>2</sub>	25 (1)	3.2 (125)	21-26	185	2.4 (5.3)	2.1 (4.6)	86-88
		4.4 (175)	22-27	215	3.3 (7.4)	2.9 (6.4)	
		5.1 (200)	23-28	235	3.8 (8.4)	3.3 (7.3)	
		5.7 (225)	24-29	265	4.3 (9.5)	3.7 (8.2)	
		6.4 (250)	25-30	285	4.8 (10.5)	4.2 (9.2)	
		7.6 (300)	27-31	315	5.7 (12.6)	5.0 (11.0)	
		8.3 (325)	26-33	335	6.2 (13.7)	5.4 (11.9)	
		8.9 (350)	29-34	365	6.7 (14.7)	5.8 (12.8)	
10.2 (400)	30-36	395	7.6 (16.8)	6.6 (14.6)			

<sup>(1)</sup>Typical all weld metal. <sup>(2)</sup>Measured with 0.2% offset. <sup>(3)</sup>See test results disclaimer <sup>(4)</sup>As-Welded with 100% CO<sub>2</sub> <sup>(5)</sup>To estimate ESO, subtract 1/4 in (6.0 mm) from CTWD.  
NOTE: FEMA and AWS D1.8 structural steel seismic supplement test data can be found on this product at [www.lincolnelectric.com](http://www.lincolnelectric.com).

# ULTRACORE® 712C

Mild Steel, All Position ■ AWS E71T-12C-JH8, E71T1-C1A4-CS2-H8



## KEY FEATURES

- Capable of producing weld deposits with impact toughness exceeding 27 J (20 ft•lbf) at -40°C (-40°F)
- Designed for welding with 100% CO<sub>2</sub> shielding gas
- Premium arc performance and bead appearance
- ProTech® foil bag packaging

## WELDING POSITIONS

All

## SHIELDING GAS

100% CO<sub>2</sub>  
Flow Rate: 40-50 CFH

## CONFORMANCES

<b>AWS A5:</b>	E71T1-C1A4-CS2-H8, E71T-12C-JH8, E71T-1C-JH8, E71T-9C-JH8
<b>ABS:</b>	3YSA H10
<b>CWB/CSA:</b>	E491T1-C1A4-CS2-H8 E491T-9J-H8
<b>DNV:</b>	III YMS H10
<b>Lloyd's Register:</b>	3YS H10
<b>AWS D1.8:</b>	1/16"
<b>ISO:</b>	T49 4 T12-1 C1 A-K H10

## TYPICAL APPLICATIONS

- Bridge fabrication
- Pressure vessels
- Shipbuilding
- Offshore
- ASME related applications

## DIAMETERS / PACKAGING

Diameter in (mm)	15 lb (6.8 kg) Plastic Spool 60 lb (27.2 kg) Master Carton	33 lb (15 kg) Spool**	50 lb (22.7 kg) Fiber Spool	500 lb (227 kg) Accu-Trak® Drum
0.045 (1.1)	ED031894	ED031672, ED032754*		ED031681
0.052 (1.3)	ED031895	ED031673, ED034418*	ED031839, ED034420*	ED031879
1/16 (1.6)	ED031896	ED031674, ED034419*	ED031840, ED034421*	ED031799

\*Buy America Product \*\*Spool may be plastic or fiber.

## MECHANICAL PROPERTIES<sup>(1)</sup>

	Yield Strength <sup>(2)</sup> MPa (ksi)	Tensile Strength MPa (ksi)	Elongation %	Charpy V-Notch J (ft•lbf)		
				@ -18°C (0°F)	@ -29°C (-20°F)	@ -40°C (-40°F)
<b>Requirements<sup>(4)</sup></b> AWS E71T-1C-JH8 AWS E71T-9C-JH8 AWS E71T-12C-JH8	400 (58) min	480-655 (70-95) 480-620 (70-90)	22 min	27 (20) min Not Specified Not Specified	Not Specified 27 (20) min 27 (20) min	27 (20) min
<b>Typical Results<sup>(3)</sup></b> As-Welded with 100% CO <sub>2</sub>	485-535 (70-77)	540-585 (78-84)	25-28	135-193 (100-143)	91-164 (67-121)	57-133 (42-98)

**DEPOSIT COMPOSITION<sup>(1)</sup>**

	%C	%Mn	%Si	%S	%P	%Ni	Diffusible Hydrogen (mL/100g weld deposit)
<b>Requirements<sup>(4)</sup></b> AWS E71T-1C-JH8, E71T-9C-JH8 AWS E71T-12C-JH8	0.12 max	1.75 max 1.60 max	0.90 max	0.03 max	0.03 max	0.50 max	8.0 max
<b>Typical Results<sup>(3)</sup></b> As-Welded with 100% CO <sub>2</sub>	0.03	1.34-1.49	0.26-0.32	0.01	0.01-0.02	0.33-0.41	3-8

**TYPICAL OPERATING PROCEDURES**

Diameter, Polarity Shielding Gas	CTWD <sup>(5)</sup> mm (in)	Wire Feed Speed m/min (in/min)	Voltage (volts)	Approx. Current (amps)	Melt-Off Rate kg/hr (lb/hr)	Deposition Rate kg/hr (lb/hr)	Efficiency (%)
0.045 in (1.1 mm), DC+ As-Welded with 100% CO <sub>2</sub>	25 (1)	4.4 (175)	24-29	115	1.8 (3.9)	1.5 (3.4)	85-88
		6.4 (250)	25-30	140	2.5 (5.6)	2.2 (4.8)	
		7.6 (300)	26-31	155	3.1 (6.8)	2.6 (5.8)	
		8.9 (350)	26-31	170	3.6 (7.9)	3.1 (6.8)	
		10.2 (400)	26-31	185	4.1 (9.0)	3.5 (7.8)	
		11.4 (450)	27-32	200	4.6 (10.1)	4.0 (8.8)	
		12.7 (500)	27-32	215	5.1 (11.3)	4.4 (9.8)	
		14.0 (550)	28-33	230	5.6 (12.4)	4.9 (10.8)	
		15.2 (600)	28-33	245	6.1 (13.5)	5.3 (11.7)	
0.052 in (1.3 mm), DC+ As-Welded with 100% CO <sub>2</sub>	25 (1)	3.8 (150)	24-29	140	2.1 (4.7)	1.7 (3.8)	85-88
		5.1 (200)	25-30	160	2.9 (6.3)	2.4 (5.2)	
		6.4 (250)	26-31	180	3.5 (7.8)	3.0 (6.5)	
		7.6 (300)	26-31	205	4.3 (9.4)	3.6 (7.9)	
		8.9 (350)	27-32	225	5.0 (11.0)	4.2 (9.2)	
		9.5 (375)	27-32	235	5.3 (11.7)	4.5 (9.9)	
		10.8 (425)	27-32	255	6.0 (13.3)	5.1 (11.2)	
		12.1 (475)	28-33	275	6.8 (14.9)	5.7 (12.6)	
		12.7 (500)	28-33	290	7.1 (15.6)	6.0 (13.3)	
1/16 in (1.6 mm), DC+ As-Welded with 100% CO <sub>2</sub>	25 (1)	3.8 (150)	23-28	200	2.9 (6.4)	2.4 (5.3)	85-88
		4.4 (175)	24-29	215	3.4 (7.5)	2.9 (6.3)	
		5.1 (200)	24-29	230	3.9 (8.5)	3.3 (7.2)	
		5.7 (225)	24-29	245	4.4 (9.6)	3.7 (8.1)	
		6.4 (250)	25-30	255	4.8 (10.6)	4.1 (9.1)	
		7.6 (300)	25-30	285	5.8 (12.7)	4.9 (10.9)	
		8.3 (325)	26-31	300	6.3 (13.8)	5.4 (11.9)	
		8.9 (350)	26-31	310	6.7 (14.8)	5.8 (12.8)	
		10.2 (400)	27-32	340	7.7 (16.9)	6.7 (14.7)	

<sup>(1)</sup>Typical all weld metal. <sup>(2)</sup>Measured with 0.2% offset. <sup>(3)</sup>See test results disclaimer <sup>(4)</sup>As-Welded with 100% CO<sub>2</sub>. <sup>(5)</sup>To estimate ESO, subtract 1/4 in (6.0 mm) from CTWD.  
NOTE: This product contains micro-alloying elements. Additional information available upon request.

# ULTRACORE® 712C-H PLUS

Mild Steel, All Positions ▪ AWS E71T-12C-JH4, E71T1-C1A6-CS2-H4

## KEY FEATURES

- Innovative design capable of superior toughness at -50°F in both the as-welded and stress-relieved conditions
- Designed for welding with 100% CO<sub>2</sub> shielding gas
- H4 diffusible hydrogen levels
- Q2 Lot® - Certificate showing actual deposit chemistry and mechanical properties per lot available online
- ProTech® foil bag packaging

## CONFORMANCES

- AWS A5:** E71T1-C1A6-CS2-H4, E71T1-C1P5-CS2-H4  
E71T-12C-JH4, E81T1-GC
- ABS:** 4YSA H5
- CWB/CSA:** E491T-12J-H4, E491T1-C1A5-CS2-H4
- DNV:** IV Y40MS H5
- Lloyd's Register:** 4YS H5

## WELDING POSITIONS

All

## SHIELDING GAS

100% CO<sub>2</sub>  
Flow Rate: 40-50 CFH

## TYPICAL APPLICATIONS

- Offshore platforms & pipe systems
- Oil & gas pipelines
- Petrochemical pipelines
- Pressure vessels
- Bridge fabrication

## DIAMETERS / PACKAGING

Diameter in (mm)	33 lb (15kg) Plastic Spool
0.045 (1.1)	ED034849
0.052 (1.3)	ED034848
1/16 (1.6)	ED034850

## MECHANICAL PROPERTIES<sup>(1)</sup> - As required per AWS A5.20 & AWS A5.36

	Yield Strength <sup>(2)</sup> MPa (ksi)	Tensile Strength MPa (ksi)	Elongation (%)	Charpy V-Notch J (ft·lbf)		
				-40°C (40°F)	-46°C (-50°F)	@ -51°C (-60°F)
<b>Requirements</b>						
AWS A5.20: E71T-12C-JH4 As-Welded with 100% CO <sub>2</sub>	400 (58) min	480-620 (70-90)	22 min	27 (20) min	-	-
AWS A5.36: E71T1-C1A6-CS2-H4 As-Welded with 100% CO <sub>2</sub>	400 (58) min	480-655 (70-95)	22 min	-	-	27 (20) min
AWS A5.36: E71T1-C1P5-CS2-H4 Stress Relieved with 100% CO <sub>2</sub> for 1 hr @ 621°C (1150°F)	400 (58) min	480-655 (70-95)	22 min	-	27 (20) min	-
<b>Typical Results<sup>(3)</sup></b>						
As-Welded with 100% CO <sub>2</sub>	490-530 (71-77)	560-585 (81-85)	25-27	89-156 (66-115)	73-148 (54-109)	66-132 (49-97)
Stress Relieved with 100% CO <sub>2</sub> for 1 hr @ 621°C (1150°F)	420-470 (61-68)	530-565 (77-82)	29-34	115-178 (85-131)	95-148 (70-109)	-

<sup>(1)</sup> Typical all weld metal. <sup>(2)</sup> Measure with 0.2% offset. <sup>(3)</sup> See test results disclaimer

**DEPOSIT COMPOSITION<sup>(1)</sup>**

	%C	%Mn	%Si	%S
<b>Requirements</b> AWS A5.20: E71T-12C-JH4	0.12 max	1.60 max	0.90 max	0.03 max
AWS A5.36: E71T1-C1A6-CS2-H4, E71T1-C1P5-CS2-H4				0.030 max
<b>Typical Results<sup>(3)</sup></b> with 100% CO <sub>2</sub>	0.04-0.05	1.48-1.57	0.45-0.50	0.008
	%P	%Ni	Diffusible Hydrogen (mL/100g weld deposit)	
<b>Requirements</b> AWS A5.20: E71T-12C-JH4	0.03 max	0.50 max	4.0 max	
AWS A5.36: E71T1-C1A6-CS2-H4, E71T1-C1P5-CS2-H4	0.030 max		4 max	
<b>Typical Results<sup>(3)</sup></b> with 100% CO <sub>2</sub>	0.013	0.02	2-4	

**TYPICAL OPERATING PROCEDURES**

Diameter, Polarity Shielding Gas	CTWD <sup>(4)</sup> mm (in)	Wire Feed Speed m/min (in/min)	Voltage (Volts)	Approx. Current (amps)	Melt-Off Rate kg/hr (lb/hr)	Deposition Rate kg/hr (lb/hr)	Efficiency (%)
<b>0.045 in (1.1 mm), DC+ 100% CO<sub>2</sub></b>							
Optimal Settings	22 (7/8)	11.2 (440)	29	220	1.8-6.1 (3.9-13.5)	1.5-5.1 (3.4-11.3)	83-88
Min - Max	19-25 (3/4-1)	4.4-13.3 (175-525)	23-32	115-245			
<b>0.052 in (1.3 mm), DC+ 100% CO<sub>2</sub></b>							
Optimal Settings	25 (1)	8.6 (340)	30	235	2.1-7.1 (4.7-15.6)	1.7-6.0 (3.8-13.3)	80-86
Min - Max	19-25 (3/4-1)	3.8-10.2 (150-400)	23-32	140-290			
<b>1/16 in (1.6 mm), DC+ 100% CO<sub>2</sub></b>							
Optimal Settings	25 (1)	7.6 (300)	28	295	2.9-6.7 (6.4-14.8)	2.4-5.8 (5.3-12.8)	82-87
Min - Max	19-25 (3/4-1)	3.8-8.9 (150-350)	22-31	200-360			

<sup>(1)</sup> Typical all weld metal. <sup>(3)</sup> See test results disclaimer <sup>(4)</sup> To estimate ESO, subtract 1/4 in (6.0 mm) from CTWD.



# ULTRACORE® 712A80

Mild Steel, All Position ■ AWS E71T-12M-JH8, E71T1-M21A4-CS2-H8



## KEY FEATURES

- Capable of producing weld deposits with impact toughness exceeding 27 J (20 ft•lbf) at -40°C (-40°F)
- Designed for welding with 75-80% Argon/balance CO<sub>2</sub> shielding gas
- Premium arc performance and bead appearance
- ProTech® foil bag packaging

## WELDING POSITIONS

All

## SHIELDING GAS

75% - 80% Argon / Balance CO<sub>2</sub>  
Flow Rate: 40 - 50 CFH

## CONFORMANCES

<b>AWS A5:</b>	E71T1-M21A4-CS2-H8, E71T-12M-JH8, E71T-1M-JH8, E71T-9M-JH8
<b>ABS:</b>	4YSA H10
<b>CWB/CSA:</b>	E491T-12MJ-H8, E491T1-M21A4-CS1-H8, E491T1-M21A4-CS2-H8, E491T-9MJ-H8
<b>DNV:</b>	IV YMS H10
<b>Lloyd's Register:</b>	4YS H10
<b>ISO:</b>	T49 4 T12-1 M21 A-K H10

## TYPICAL APPLICATIONS

- Offshore
- Pressure vessels
- Shipbuilding
- Heavy equipment
- ASME related applications

## DIAMETERS / PACKAGING

Diameter in (mm)	15 lb (6.8 kg) Plastic Spool 60 lb (27.2 kg) Master Carton	33 lb (15 kg) Spool**	50 lb (22.7 kg) Fiber Spool	500 lb (227 kg) Accu-Trak® Drum
0.045 (1.1)		ED031675	ED031850	ED032050
0.052 (1.3)	ED035405	ED031676	ED031851	ED032051
1/16 (1.6)	ED031890	ED031677, ED036415*	ED031852	ED032052

\*Buy America Product \*\*Spool may be plastic or fiber.

## MECHANICAL PROPERTIES<sup>(1)</sup>

	Yield Strength <sup>(2)</sup> MPa (ksi)	Tensile Strength MPa (ksi)	Elongation %	Charpy V-Notch J (ft•lbf)		
				@ -18°C (0°F)	@ -29°C (-20°F)	@ -40°C (-40°F)
<b>Requirements<sup>(4)</sup></b> AWS E71T-1M-JH8 AWS E71T-9M-JH8 AWS E71T-12M-JH8	400 (58) min	480-655 (70-95) 480-620 (70-90)	22 min	27 (20) min Not Specified Not Specified	Not Specified 27 (20) min 27 (20) min	27 (20) min
<b>Typical Results<sup>(3)</sup></b> As-Welded with 75%-80% Ar/balance CO <sub>2</sub>	505-555 (73-80)	565-610 (82-88)	25-27	166-186 (123-137)	100-160 (74-118)	72-142 (53-105)

<sup>(1)</sup>Typical all weld metal. <sup>(2)</sup>Measured with 0.2% offset. <sup>(3)</sup>See test results disclaimer <sup>(4)</sup>As-Welded 75%-80% Argon/Balance CO<sub>2</sub>

**DEPOSIT COMPOSITION<sup>(1)</sup>**

	%C	%Mn	%Si	%S	%P	%Ni	Diffusible Hydrogen (mL/100g weld deposit)
<b>Requirements<sup>(4)</sup></b> AWS E71T-1M-JH8, E71T-9M-JH8 AWS E71T-12M-JH8	0.12 max	1.75 max 1.60 max	0.90 max	0.03 max	0.03 max	0.50 max	8.0 max
<b>Typical Results<sup>(3)</sup></b> As-Welded with 75%-80% Ar/balance CO <sub>2</sub>	0.03-0.04	1.40-1.53	0.31-0.36	0.01	0.01	0.32-0.38	4 - 8

**TYPICAL OPERATING PROCEDURES**

Diameter, Polarity Shielding Gas	CTWD <sup>(5)</sup> mm (in)	Wire Feed Speed m/min (in/min)	Voltage (volts)	Approx. Current (amps)	Melt-Off Rate kg/hr (lb/hr)	Deposition Rate kg/hr (lb/hr)	Efficiency (%)
0.045 in (1.1 mm), DC+ 75%-80% Ar/ balance CO <sub>2</sub>	25 (1)	4.4 (175)	20-25	140	1.8 (4.0)	1.6 (3.5)	86-88
		5.7 (225)	21-26	150	2.3 (5.1)	2.0 (4.5)	
		7.0 (275)	22-27	165	2.8 (6.3)	2.5 (5.5)	
		8.3 (325)	22-27	190	3.4 (7.4)	2.9 (6.5)	
		8.9 (350)	23-28	205	3.6 (8.0)	3.2 (7.0)	
		10.2 (400)	24-29	230	4.1 (9.1)	3.6 (8.0)	
		11.4 (450)	25-31	245	4.7 (10.3)	4.1 (9.0)	
		12.1 (475)	26-32	265	4.9 (10.8)	4.3 (9.5)	
13.3 (525)	27-33	280	5.4 (12.0)	4.7 (10.4)			
0.052 in (1.3 mm), DC+ 75%-80% Ar/ balance CO <sub>2</sub>	25 (1)	3.8 (150)	20-25	150	2.0 (4.5)	1.8 (3.9)	86-88
		4.4 (175)	21-26	165	2.4 (5.2)	2.1 (4.6)	
		5.1 (200)	22-27	190	2.7 (6.0)	2.4 (5.2)	
		5.7 (225)	23-28	215	3.1 (6.7)	2.7 (5.9)	
		6.4 (250)	24-29	235	3.4 (7.5)	2.9 (6.5)	
		7.6 (300)	25-30	255	4.1 (9.0)	3.5 (7.8)	
		8.3 (325)	27-31	275	4.4 (9.7)	3.8 (8.5)	
		8.9 (350)	28-32	295	4.7 (10.5)	4.1 (9.1)	
11.4 (450)	29-34	330	6.1 (13.5)	5.3 (11.7)			
1/16 in (1.6 mm), DC+ 75%-80% Ar/ balance CO <sub>2</sub>	25 (1)	3.8 (150)	21-26	200	2.9 (6.3)	2.5 (5.5)	86-88
		4.4 (175)	22-27	215	3.3 (7.4)	2.9 (6.4)	
		5.1 (200)	22-28	235	3.8 (8.4)	3.3 (7.3)	
		5.7 (225)	24-29	265	4.3 (9.5)	3.7 (8.2)	
		6.4 (250)	25-30	285	4.8 (10.5)	4.2 (9.2)	
		7.6 (300)	26-31	315	5.7 (12.6)	5.0 (11.0)	
		8.3 (325)	27-32	335	6.2 (13.7)	5.4 (11.9)	
		8.9 (350)	28-33	365	6.7 (14.7)	5.8 (12.8)	
10.2 (400)	29-34	415	7.6 (16.8)	6.6 (14.6)			

<sup>(1)</sup>Typical all weld metal. <sup>(2)</sup>Measured with 0.2% offset. <sup>(3)</sup>See test results disclaimer <sup>(4)</sup>As-Welded 75%-80% Argon/Balance CO<sub>2</sub> <sup>(5)</sup>To estimate ESO, subtract 1/4 in (6.0 mm) from CTWD.

# ULTRACORE® 712A80-H

Mild Steel, All Position ■ AWS E71T-12M-JH4, E71T1-M21A4-CS2-H4

## KEY FEATURES

- Capable of producing low hydrogen weld deposits with impact toughness exceeding 27 J (20 ft•lbf) at -40°C (-40°F)
- Designed for welding with 75-80% Argon/Balance CO<sub>2</sub> gas
- Premium arc performance and bead appearance
- ProTech® foil bag packaging
- Meets H4 diffusible hydrogen levels

## WELDING POSITIONS

All

## SHIELDING GAS

75% - 80% Argon / Balance CO<sub>2</sub>  
Flow Rate: 40 - 50 CFH

## CONFORMANCES

<b>AWS A5:</b>	E71T1-M21A4-CS2-H4, E71T-12M-JH4, E71T-1M-JH4, E71T-9M-JH4
<b>ABS:</b>	4YSA H5
<b>CWB/CSA:</b>	E491T-12MJ-H4, E491T1-M21A4-CS1-H4, E491T1-M21A4-CS2-H4, E491T-9MJ-H4
<b>DNV:</b>	IV YMS H5
<b>Lloyd's Register:</b>	4YS H5
<b>ISO:</b>	T49 4 T12-1 M21 A-K H5

## TYPICAL APPLICATIONS

- Offshore
- Heavy equipment
- Shipbuilding
- Pressure vessels

## DIAMETERS / PACKAGING

Diameter in (mm)	15 lb (6.8 kg) Plastic Spool 60 lb (27.2 kg) Master Carton	33 lb (15 kg) Spool*
0.045 (1.1)	ED031891	ED031678
0.052 (1.3)		ED031679
1/16 (1.6)	ED031893	ED031680

\*Spool may be plastic or fiber.

## MECHANICAL PROPERTIES<sup>(1)</sup>

	Yield Strength <sup>(2)</sup> MPa (ksi)	Tensile Strength MPa (ksi)	Elongation %	Charpy V-Notch J (ft•lbf)		
				@ -18°C (0°F)	@ -29°C (-20°F)	@ -40°C (-40°F)
<b>Requirements<sup>(4)</sup></b> AWS E71T-1M-JH4 AWS E71T-9M-JH4 AWS E71T-12M-JH4	400 (58) min	480-655 (70-95) 480-620 (70-90)	22 min	27 (20) min Not Specified Not Specified	Not Specified 27 (20) min 27 (20) min	27 (20) min
<b>Typical Results<sup>(3)</sup></b> As-Welded with 75%-80% Ar/balance CO <sub>2</sub>	490-570 (71-83)	550-615 (80-89)	27-28	149-180 (111-133)	56-164 (41-121)	27-98 (20-72)

<sup>(1)</sup>Typical all weld metal. <sup>(2)</sup>Measured with 0.2% offset. <sup>(3)</sup>See test results disclaimer. <sup>(4)</sup>As-Welded 75%-80% Argon/Balance CO<sub>2</sub>.

**DEPOSIT COMPOSITION<sup>(1)</sup>**

	%C	%Mn	%Si	%S	%P	%Ni	Diffusible Hydrogen (mL/100g weld deposit)
<b>Requirements<sup>(4)</sup></b> AWS E71T-1M-JH4, E71T-9M-JH4 AWS E71T-12M-JH4	0.12 max	1.75 max 1.60 max	0.90 max	0.03 max	0.03 max	0.50 max	4.0 max
<b>Typical Results<sup>(3)</sup></b> As-Welded with 75%-80% Ar/balance CO <sub>2</sub>	0.03-0.04	1.25-1.37	0.28-0.33	0.01	0.01	0.35-0.41	2-4

**TYPICAL OPERATING PROCEDURES**

Diameter, Polarity Shielding Gas	CTWD <sup>(5)</sup> mm (in)	Wire Feed Speed m/min (in/min)	Voltage (volts)	Approx. Current (amps)	Melt-Off Rate kg/hr (lb/hr)	Deposition Rate kg/hr (lb/hr)	Efficiency (%)
0.045 in (1.1 mm), DC+ 75%-80% Ar/ balance CO <sub>2</sub>	25 (1)	4.4 (175)	21-25	140	1.8 (4.0)	1.6 (3.5)	86-88
		5.1 (200)	22-26	150	2.1 (4.6)	1.8 (4.0)	
		6.4 (250)	23-27	165	2.6 (5.7)	2.3 (5.0)	
		7.6 (300)	23-28	190	3.1 (6.8)	2.7 (6.0)	
		8.9 (350)	24-29	205	3.6 (8.0)	3.2 (7.0)	
		9.5 (375)	25-30	230	3.9 (8.6)	3.4 (7.5)	
		10.8 (425)	26-31	245	4.4 (9.7)	3.8 (8.5)	
		12.1 (475)	27-32	265	4.9 (10.8)	4.3 (9.5)	
0.052 in (1.3 mm), DC+ 75%-80% Ar/ balance CO <sub>2</sub>	25 (1)	3.8 (150)	21-25	150	2.0 (4.5)	1.8 (3.9)	86-88
		4.7 (185)	22-26	165	2.5 (5.5)	2.2 (4.8)	
		5.7 (225)	23-27	190	3.1 (6.7)	2.7 (5.9)	
		6.4 (250)	24-28	215	3.4 (7.5)	2.9 (6.5)	
		6.9 (275)	24-29	235	3.7 (8.2)	3.2 (7.2)	
		7.6 (300)	24-30	255	4.1 (9.0)	3.5 (7.8)	
		8.5 (335)	25-31	275	4.5 (10.0)	4.0 (8.7)	
		9.5 (375)	26-32	295	5.1 (11.2)	4.4 (9.8)	
1/16 in (1.6 mm), DC+ 75%-80% Ar/ balance CO <sub>2</sub>	25 (1)	3.8 (150)	22-26	200	2.9 (6.3)	2.5 (5.5)	86-88
		4.4 (175)	23-27	210	3.3 (7.4)	2.9 (6.4)	
		5.1 (200)	24-29	235	3.8 (8.4)	3.3 (7.3)	
		5.7 (225)	24-29	265	4.3 (9.5)	3.7 (8.2)	
		6.4 (250)	24-30	285	4.8 (10.5)	4.2 (9.2)	
		6.9 (275)	26-31	315	5.3 (11.6)	4.6 (10.1)	
		8.3 (325)	27-32	335	6.2 (13.7)	5.4 (11.9)	
		8.9 (350)	28-33	365	6.7 (14.7)	5.8 (12.8)	

<sup>(1)</sup>Typical all weld metal. <sup>(2)</sup>Measured with 0.2% offset. <sup>(3)</sup>See test results disclaimer <sup>(4)</sup>As-Welded 75%-80% Argon/Balance CO<sub>2</sub> <sup>(5)</sup>To estimate ESO, subtract 1/4 in (6.0 mm) from CTWD.  
NOTE: This product contains micro-alloying elements. Additional information available upon request.

# ULTRACORE® 712A80-H PLUS

Mild Steel, All Positions ▪ AWS E71T-12M-JH4, E71T1-M21A6-CS2-H4, E81T1-GM

## KEY FEATURES

- Innovative design capable of superior toughness at -50°F in both the as-welded and stress-relieved conditions
- Designed for welding with 75-80% Argon/Balance CO<sub>2</sub> shielding gas
- H4 diffusible hydrogen levels
- Q2 Lot® - Certificate showing actual deposit chemistry and mechanical properties per lot available online
- ProTech® foil bag packaging

## CONFORMANCES

- AWS A5:** E71T1-M21A6-CS2-H4, E71T1-M21P5-CS2-H4, E71T-12M-JH4, E71T-1M-JH4, E71T-9M-JH4 E81T1-GM
- ABS:** 4YSA H5
- CWB/CSA:** E491T-12M-J-H4 E491T1-M21A5-CS2-H4
- DNV:** IV YMS H5
- Lloyd's Register:** 4YS H5

## WELDING POSITIONS

All

## SHIELDING GAS

75-80% Argon / Balance CO<sub>2</sub>  
Flow Rate: 40-50 CFH

## TYPICAL APPLICATIONS

- Offshore Platforms & Pipe Systems
- Oil & Gas Pipelines
- Petrochemical Pipelines
- Pressure Vessels
- Bridge Fabrication

## DIAMETERS / PACKAGING

Diameter in (mm)	33 lb (15kg) Plastic Spool
0.045 (1.1)	ED034845
0.052 (1.3)	ED034846
1/16 (1.6)	ED034847

## MECHANICAL PROPERTIES<sup>(1)</sup>

	Yield Strength <sup>(2)</sup> MPa (ksi)	Tensile Strength MPa (ksi)	Elongation (%)	Charpy V-Notch J (ft·lbf)		
				-40°C (40°F)	-46°C (-50°F)	@ -51°C (-60°F)
<b>Requirements</b>						
AWS A5.20: E71T-12M-JH4 As-Welded with 75-80% Ar/balance CO <sub>2</sub>	400 (58) min	480-620 (70-90)	22 min	27 (20) min	-	-
AWS A5.36: E71T1-M21A6-CS2-H4 As-Welded with 75-80% Ar/balance CO <sub>2</sub>	400 (58) min	480-655 (70-95)	22 min	-	-	27 (20) min
AWS A5.36: E71T1-M21P5-CS2-H4 Stress Relieved with 75-80% Ar/ balance CO <sub>2</sub> for 1 hr @ 621°C (1150°F)	400 (58) min	480-655 (70-95)	22 min	-	27 (20) min	-
AWS A5.29: E81T1-GM As-Welded with 75-80% Ar/balance CO <sub>2</sub>	470 (68) min	550-690 (80-100)	19 min	-	-	-
<b>Typical Results<sup>(3)</sup></b>						
As-Welded with 75-80% Ar/balance CO <sub>2</sub>	530-545 (77-79)	590-605 (86-88)	26-28	95-150 (69-112)	65-145 (49-106)	75-140 (55-102)
Stress Relieved with 75-80% Ar/balance CO <sub>2</sub> for 1 hr @ 621°C (1150°F)	445-470 (65-68)	545-565 (79-82)	31-33	85-150 (62-109)	60-125 (43-91)	-

<sup>(1)</sup> Typical all weld metal. <sup>(2)</sup> Measure with 0.2% offset. <sup>(3)</sup> See test results disclaimer

**DEPOSIT COMPOSITION<sup>(1)</sup>**

	%C	%Mn	%Si	%S
<b>Requirements</b> AWS A5.20: E71T-12M-JH4	0.12 max	1.60 max	0.90 max	0.03 max
AWS A5.36: E71T1-M21A6-CS2-H4, E71T1-M21P5-CS2-H4 AWS A5.29: E81T1-GM				0.030 max
<b>Typical Results<sup>(3)</sup></b> with 75-80% Ar / Balance CO <sub>2</sub>				0.04-0.05
	%P	%Ni	Diffusible Hydrogen (mL/100g weld deposit)	
<b>Requirements</b> AWS A5.20: E71T-12M-JH4	0.03 max	0.50 max	4.0 max	
AWS A5.36: E71T1-M21A6-CS2-H4, E71T1-M21P5-CS2-H4 AWS A5.29: E81T1-GM	0.030 max		4 max	
<b>Typical Results<sup>(3)</sup></b> with 75-80% Ar / Balance CO <sub>2</sub>	0.015		0.04	2-4

**TYPICAL OPERATING PROCEDURES**

Diameter, Polarity Shielding Gas	CTWD <sup>(4)</sup> mm (in)	Wire Feed Speed m/min (in/min)	Voltage (Volts)	Approx. Current (amps)	Melt-Off Rate kg/hr (lb/hr)	Deposition Rate kg/hr (lb/hr)	Efficiency (%)	
0.045 in (1.1 mm), DC+ 75-80% Ar/balance CO <sub>2</sub>								
	Optimal Settings	22 (7/8)	11.2 (440)	28	220	1.8-5.2 (4.0-11.4)	1.6-4.7 (3.5-10.4)	84-91
	Min - Max	19-25 (3/4-1)	4.4-12.7 (175-500)	21-33	140-275			
0.052 in (1.3 mm), DC+ 75-80% Ar/balance CO <sub>2</sub>								
	Optimal Settings	25 (1)	8.6 (340)	29	235	2.0-5.4 (4.5-12.0)	1.8-4.7 (3.9-10.4)	84-87
	Min - Max	19-25 (3/4-1)	3.8-10.2 (150-400)	21-33	150-310			
1/16 in (1.6 mm), DC+ 75-80% Ar/balance CO <sub>2</sub>								
	Optimal Settings	25 (1)	7.6 (300)	27	295	2.9-6.7 (6.3-14.7)	2.5-5.8 (5.5-12.8)	83-87
	Min - Max	19-25 (3/4-1)	3.8-8.9 (150-350)	22-33	200-365			

<sup>(1)</sup> Typical all weld metal. <sup>(3)</sup> See test results disclaimer. <sup>(4)</sup> To estimate ESO, subtract 1/4 in (6.0 mm) from CTWD.

# ULTRACORE® CLARITY™ C71 LE

Mild Steel, All Positions ▪ AWS E71T-1C-H8, E71T1-C1A0-CS1-H8

## KEY FEATURES

- The lowest Manganese Generation Rate (MnGR) of any similarly classified electrode
- Over 80% reduction in MnGR when compared to a standard E71T-1C flux-cored electrode
- Assists efforts to reduce exposure to Mn
- Designed for welding with 100% CO<sub>2</sub> shielding gas
- H8 diffusible hydrogen levels.
- ProTech® foil bag packaging

## WELDING POSITIONS

All

## CONFORMANCES

**AWS A5:** E71T1-C1A0-CS1-H8 E71T-1C-H8

**CWB/CSA:** E491T-1-H8

## TYPICAL APPLICATIONS

- General Fabrication

## SHIELDING GAS

100% CO<sub>2</sub>  
Flow rate: 40-50 CFH

## DIAMETERS / PACKAGING

Diameter in (mm)	33 lb (14.9kg) Fiber Spool
0.045 (1.1)	ED036255
1/16 (1.6)	ED036254

## MECHANICAL PROPERTIES<sup>(1)</sup>

	Yield Strength <sup>(2)</sup> MPa (ksi)	Tensile Strength MPa (ksi)	Elongation (%)	Charpy V-Notch J (ft-lbf) @-18°C (0°F)
<b>Requirements</b>				
AWS A5.20: E71T-1C-H8	400 (58) min	480-655 (70-95)	22 min	27 (20) min
AWS A5.36: E71T1-C1A0-CS1-H8	400 (58) min	480-655 (70-95)	22 min	27 (20) min
<b>Typical Results<sup>(3)</sup></b>				
As-Welded with 100% CO <sub>2</sub>	405-440 (59-64)	490-530 (71-77)	25-31	34-96 (25-71)

<sup>(1)</sup> Typical all weld metal. <sup>(2)</sup> Measured with 0.2% offset. <sup>(3)</sup> See test results disclaimer

**DEPOSIT COMPOSITION<sup>(1)</sup>**

	%C	%Mn	%Si	%S
<b>Requirements</b>				
AWS A5.20: E71T-1C-H8	0.12 max	1.75 max	0.90 max	0.03 max
AWS A5.36: E71T1-C1A0-CS1-H8				0.030 max
<b>Typical Results<sup>(3)</sup></b>				
As-Welded with 100% CO <sub>2</sub>	0.08	0.11-0.13	0.40-0.50	0.005
	%P	%Ni	Diffusible Hydrogen (ml/100g weld deposit)	
<b>Requirements</b>				
AWS A5.20: E71T-1C-H8	0.03 max	0.50 max	8.0 max	
AWS A5.36: E71T1-C1A0-CS1-H8	0.030 max		8 max	
<b>Typical Results<sup>(3)</sup></b>				
As-Welded with 100% CO <sub>2</sub>	0.010	0.38-0.50	3-5	

**TYPICAL OPERATING PROCEDURES**

Diameter, Polarity Shielding Gas	CTWD <sup>(4)</sup> mm (in)	Wire Feed Speed m/min (in/min)	Voltage (Volts)	Approx. Current (amps)	Melt-Off Rate kg/hr (lb/hr)	Deposition Rate kg/hr (lb/hr)	Efficiency (%)
0.045 in (1.1 mm), DC+ 100% CO <sub>2</sub>	19 - 25 (3/4 - 1)	5.1 (200)	21-25	130	2.0 (4.5)	1.7 (3.7)	82-88
		6.4 (250)	22-26	140	2.5 (5.6)	2.1 (4.7)	
		7.6 (300)	23-28	165	3.0 (6.7)	2.6 (5.8)	
		8.9 (350)	25-30	190	3.5 (7.8)	3.1 (6.8)	
		10.2 (400)	26-31	205	4.1 (9.0)	3.5 (7.8)	
		11.4 (450)	27-32	215	4.6 (10.1)	4.0 (8.8)	
		12.7 (500)	28-33	225	5.1 (11.2)	4.4 (9.7)	
1/16 in (1.6 mm), DC+ 100% CO <sub>2</sub>	19 - 25 (3/4 - 1)	3.2 (125)	24-27	180	2.4 (5.3)	2.0 (4.3)	82-88
		3.8 (150)	25-28	205	2.9 (6.4)	2.6 (5.7)	
		5.1 (200)	25-29	235	3.8 (8.4)	3.3 (7.3)	
		6.4 (250)	26-30	260	4.7 (10.4)	4.1 (9.1)	
		7.6 (300)	27-31	310	5.7 (12.5)	5.1 (11.0)	
		10.2 (400)	31-34	390	7.7 (16.9)	6.8 (14.9)	
		12.7 (500)	33-36	450	11.5 (25.4)	8.6 (18.9)	

<sup>(1)</sup>Typical all weld metal. <sup>(2)</sup>Measured with 0.2% offset. <sup>(3)</sup>See test results disclaimer <sup>(4)</sup>To estimate ESO, subtract 1/4 in (6.0 mm) from CTWD.



# ULTRACORE® CLARITY™ M71 LE

Mild Steel, All Positions ▪ AWS E71T-1M-H8, E71T1-M21A0-CS1-H8

## KEY FEATURES

- The lowest Manganese Generation Rate (MnGR) of any similarly classified electrode
- Over 80% reduction in MnGR when compared to a standard E71T1-1M flux-cored electrode
- Assists efforts to reduce exposure to Mn
- Designed for welding with 75% Argon / 25% CO<sub>2</sub> shielding gas
- H8 diffusible hydrogen levels
- ProTech® foil bag packaging

## WELDING POSITIONS

All

## CONFORMANCES

**AWS A5.20:** E71T-1M-H8  
**AWS A5.36:** E71T1-M21A0-CS1-H8  
**CWB/CSA W48-06:** E491T-9M-H8\*  
*\*1/16 diameter only, others pending*

## TYPICAL APPLICATIONS

- General Fabrication

## SHIELDING GAS

75% Argon / 25% CO<sub>2</sub>  
 Flow rate: 40-50 CFH

## DIAMETERS / PACKAGING

Diameter in (mm)	33 lb (14.9kg) Fiber Spool
0.045 (1.1)	ED036253
1/16 (1.6)	ED036252

## MECHANICAL PROPERTIES<sup>(1)</sup>

	Yield Strength <sup>(2)</sup> MPa (ksi)	Tensile Strength MPa (ksi)	Elongation (%)	Charpy V-Notch J (ft·lbf) @-18°C (0°F)
<b>Requirements</b>				
AWS A5.20: E71T-1M-H8	400 (58) min	480-655 (70-95)	22 min	27 (20) min
AWS A5.36: E71T1-M21A0-CS1-H8	400 (58) min	480-655 (70-95)	22 min	27 (20) min
<b>Typical Results<sup>(3)</sup></b>				
As-Welded with 75% Ar/25% CO <sub>2</sub>	430-440 (62-64)	525-540 (76-78)	25-26	38-85 (28-63)

<sup>(1)</sup> Typical all weld metal. <sup>(2)</sup> Measured with 0.2% offset. <sup>(3)</sup> See test results disclaimer

**DEPOSIT COMPOSITION<sup>(1)</sup>**

	%C	%Mn	%Si	%S
<b>Requirements</b>				
AWS A5.20: E71T-1M-H8	0.12 max	1.75 max	0.90 max	0.03 max
AWS A5.36: E71T1-M21A0-CS1-H8				0.030 max
<b>Typical Results<sup>(3)</sup></b>				
As-Welded with 75% Ar/25% CO <sub>2</sub>	0.08-0.09	0.12-0.14	0.49-0.54	0.006-0.007
	%P	%Ni	Diffusible Hydrogen (ml/100g weld deposit)	
<b>Requirements</b>				
AWS A5.20: E71T-1M-H8	0.03 max	0.50 max	8.0 max	
AWS A5.36: E71T1-M21A0-CS1-H8	0.030 max		8 max	
<b>Typical Results<sup>(3)</sup></b>				
As-Welded with 75% Ar/25% CO <sub>2</sub>	0.010	0.44-0.46	4-6	

**TYPICAL OPERATING PROCEDURES**

Diameter, Polarity Shielding Gas	CTWD <sup>(4)</sup> mm (in)	Wire Feed Speed m/min (in/min)	Voltage (Volts)	Approx. Current (amps)	Melt-Off Rate kg/hr (lb/hr)	Deposition Rate kg/hr (lb/hr)	Efficiency (%)
0.045 in (1.1 mm), DC+ 75% Ar/25% CO <sub>2</sub>	19 - 25 (3/4 - 1)	5.1 (200)	20-24	165	2.1 (4.6)	1.8 (4.0)	84-88
		6.4 (250)	21-25	180	2.6 (5.8)	2.3 (5.1)	
		7.6 (300)	22-26	215	3.1 (6.9)	2.8 (6.1)	
		8.9 (350)	23-26	235	3.7 (8.1)	3.3 (7.2)	
		10.2 (400)	24-29	260	4.2 (9.3)	3.7 (8.2)	
		11.4 (450)	25-30	280	4.8 (10.6)	4.3 (9.4)	
		12.7 (500)	26-31	300	5.1 (11.2)	4.8 (10.5)	
1/16 in (1.6 mm), DC+ 75% Ar/25% CO <sub>2</sub>	19 - 25 (3/4 - 1)	3.2 (125)	22-25	170	2.2 (4.9)	2.0 (4.5)	83-90
		3.8 (150)	22-25	185	2.9 (6.3)	2.5 (5.6)	
		5.1 (200)	23-26	230	3.8 (8.4)	3.3 (7.3)	
		6.4 (250)	24-27	260	4.7 (10.4)	4.2 (9.2)	
		7.6 (300)	25-29	295	6.8 (14.9)	5.1 (11.3)	
		10.2 (400)	27-31	325	7.6 (16.7)	6.8 (14.9)	
		12.7 (500)	29-33	460	9.5 (21.0)	8.6 (19.0)	

<sup>(1)</sup>Typical all weld metal. <sup>(2)</sup>Measured with 0.2% offset. <sup>(3)</sup>See test results disclaimer. <sup>(4)</sup>To estimate ESO, subtract 1/4 in (6.0 mm) from CTWD.

# ULTRACORE® HD-C

Mild Steel, All Position ■ AWS E71T-9C-H8, E71T1-C1A2-CS1-H8



## KEY FEATURES

- High deposition rates, increase weld deposition exceeding 10 lbs/hr out-of-position
- Fast freezing slag for a flat bead shape and increased productivity in all positions, including vertical up
- Operators can set the machine on a single setting and weld in all positions
- Little or no pre-weld clean up required, weld over light rust, mill scale, and primer
- Meets AWS D1.8 seismic lot waiver requirements

## CONFORMANCES

- AWS A5:** E71T1-C1A2-CS1-H8, E71T-1C-H8, E71T-9C-H8
- ABS:** 3YSA H10
- CWB/CSA:** E491T-12MJ-H8, E491T1-M21A4-CS2-H8
- DNV:** III YMS H10
- Lloyd's Register:** 3YS H10
- ISO:** T49 3 T1-1 C1 A H10
- AWS D1.8:** 0.045", 0.052", 1/16"

## WELDING POSITIONS

All

## TYPICAL APPLICATIONS

- Shipbuilding
- General fabrication

## SHIELDING GAS

100% CO<sub>2</sub>  
Flow Rate: 40 - 50 CFH

## DIAMETERS / PACKAGING

Diameter in (mm)	15 lb (6.8 kg) Plastic Spool 60 lb (27.2 kg) Master Carton	33 lb (15 kg) Spool**	50 lb (22.7 kg) Fiber Spool	50 lb (22.7 kg) Coil	500 lb (227 kg) Accu-Trak® Drum
0.045 (1.1)	ED033756	ED033755	ED033757		
0.052 (1.3)	ED033759	ED033758	ED033760		ED034376
1/16 (1.6)	ED033762	ED033761	ED033763	ED036529*	ED033785

\*Buy America Product \*\*Spool may be plastic or fiber.

## MECHANICAL PROPERTIES<sup>(1)</sup>

	Yield Strength <sup>(2)</sup> MPa (ksi)	Tensile Strength MPa (ksi)	Elongation %	Charpy V-Notch J (ft·lbf)	
				@ -18°C (0°F)	@ -29°C (-20°F)
<b>Requirements</b> AWS E71T-1C-H8 AWS E71T-9C-H8	400 (58) min	480-660 (70-95)	22 min	27 (20) min Not Specified	Not Specified 27 (20) min
<b>Test Results<sup>(3)</sup></b> - As-Welded with 100% CO <sub>2</sub>	540-560 (78-81)	590-610 (86-89)	27	37-111 (27-82)	31-85 (23-63)

<sup>(1)</sup>Typical all weld metal. <sup>(2)</sup>Measured with 0.2% offset. <sup>(3)</sup>See test results disclaimer

**DEPOSIT COMPOSITION<sup>(1)</sup>**

	%C	%Mn	%Si
<b>Requirements</b> - AWS E71T-1C-H8, E71T-9C-H8	0.12 max	1.75 max	0.90 max
<b>Test Results<sup>(3)</sup></b> - As-Welded with 100% CO <sub>2</sub>	0.04-0.05	1.36-1.46	0.38-0.42
	%S	%P	Diffusible Hydrogen (mL/100g weld deposit)
<b>Requirements</b> - AWS E71T-1C-H8, E71T-9C-H8	0.03 max	0.03 max	8 max
<b>Test Results<sup>(3)</sup></b> - As-Welded with 100% CO <sub>2</sub>	0.01	0.01	4-6

**TYPICAL OPERATING PROCEDURES**

Diameter, Polarity Shielding Gas	CTWD <sup>(4)</sup> mm (in)	Wire Feed Speed m/min (in/min)	Voltage (Volts)	Approx. Current (Amps)	Melt-Off Rate kg/hr (lb/hr)	Deposition Rate kg/hr (lb/hr)	Efficiency (%)
0.045 in (1.1 mm), DC+ 100% CO <sub>2</sub>	19 - 25 (3/4 - 1)	4.4 (175)	22-25	145	1.8 (3.9)	1.5 (3.4)	85 - 87
		6.4 (250)	23-28	185	2.5 (5.6)	2.2 (4.8)	
		7.6 (300)	24-30	215	3.1 (6.8)	2.6 (5.8)	
		8.9 (350)	25-31	235	3.6 (7.9)	3.1 (6.8)	
		10.2 (400)	27-32	255	4.1 (9.0)	3.5 (7.8)	
		11.4 (450)	28-33	280	4.6 (10.1)	4.0 (8.8)	
		12.7 (500)	27-33	300	5.1 (11.3)	4.4 (9.8)	
		14.0 (550)	28-33	315	5.6 (12.4)	4.9 (10.8)	
15.2 (600)	30-35	335	6.1 (13.5)	5.3 (11.7)			
0.052 in (1.3 mm), DC+ 100% CO <sub>2</sub>	19 - 25 (3/4 - 1)	3.8 (150)	22-25	155	2.1 (4.7)	1.7 (3.8)	81 - 85
		5.1 (200)	23-26	190	2.9 (6.3)	2.4 (5.2)	
		6.4 (250)	23-27	225	3.5 (7.8)	2.9 (6.5)	
		7.6 (300)	24-29	265	4.3 (9.4)	3.6 (7.9)	
		8.9 (350)	26-30	285	5.0 (11.0)	4.2 (9.2)	
		9.5 (375)	27-30	310	5.3 (11.7)	4.5 (9.9)	
		10.8 (425)	28-32	325	6.0 (13.3)	5.1 (11.2)	
		12.1 (475)	29-33	345	6.8 (14.9)	5.7 (12.6)	
12.7 (500)	30-34	360	7.1 (15.6)	6.0 (13.3)			
1/16 in (1.6 mm), DC+ 100% CO <sub>2</sub>	19 - 25 (3/4 - 1)	3.8 (150)	21-26	195	2.9 (6.4)	2.4 (5.3)	84 - 87
		4.4 (175)	22-27	245	3.4 (7.5)	2.9 (6.3)	
		5.1 (200)	22-27	260	3.9 (8.5)	3.3 (7.2)	
		5.7 (225)	23-28	290	4.4 (9.6)	3.7 (8.1)	
		6.4 (250)	24-29	310	4.8 (10.6)	4.1 (9.1)	
		7.6 (300)	25-30	330	5.8 (12.7)	4.9 (10.9)	
		8.3 (325)	25-30	365	6.3 (13.8)	5.4 (11.9)	
		8.9 (350)	26-30	390	6.7 (14.8)	5.8 (12.8)	
10.2 (400)	27-31	405	7.7 (16.9)	6.7 (14.7)			

<sup>(1)</sup>Typical all weld metal. <sup>(2)</sup>Measured with 0.2% offset. <sup>(3)</sup>See test results disclaimer <sup>(4)</sup>As-Welded with 100% CO<sub>2</sub> <sup>(5)</sup>To estimate ESO, subtract 1/4 in (6.0 mm) from CTWD.

# ULTRACORE® HD-M

Mild Steel, All Position ■ AWS E71T-9M-H8, E71T1-M21A2-CS1-H8



## KEY FEATURES

- Increase weld deposition to more than 10 lbs./hr. out-of-position
- Fast freezing slag for a flat bead shape and increased productivity in all positions, including vertical up
- Operators can set the machine on a single setting and weld in all positions

## WELDING POSITIONS

All

## SHIELDING GAS

75% Argon / Balance CO<sub>2</sub>  
Flow Rate: 40 - 50 CFH

## CONFORMANCES

- AWS A5:** E71T1-M21A2-CS1-H8, E71T-1M-H8, E71T-9M-H8
- ABS:** 3YSA H10
- CWB/CSA:** E491T-9M-H8
- DNV:** III YMS H10
- Lloyd's Register:** 3YS H10
- ISO:** T49 3 T1-1 M21 A H10

## TYPICAL APPLICATIONS

- Shipbuilding
- General fabrication

## DIAMETERS / PACKAGING

Diameter in (mm)	15 lb (6.8 kg) Plastic Spool 60 lb (27.2 kg) Master Carton	33 lb (15 kg) Fiber Spool (Plastic Bag)	50 lb (23 kg) Fiber Spool (Plastic Bag)
0.045 (1.1)	ED033986	ED033989	ED033992
0.052 (1.3)	ED033987	ED033990	ED033993
1/16 (1.6)	ED033988	ED033991, ED036619*	ED033994

\*Buy America Product

## MECHANICAL PROPERTIES<sup>(1)</sup>

	Yield Strength <sup>(2)</sup> MPa (ksi)	Tensile Strength MPa (ksi)	Elongation %	Charpy V-Notch J (ft·lbf)	
				@ -18°C (0°F)	@ -29°C (-20°F)
<b>Requirements</b> AWS E71T-1M-H8 AWS E71T-9M-H8	400 (58) min	480-655 (70-95)	22 min	27 (20) min Not Specified	Not Specified 27 (20) min
<b>Test Results<sup>(3)</sup></b> As-Welded with 75% Argon / 25% CO <sub>2</sub>	570-588 (83-85)	615-633 (89-92)	26-28	54-74 (40-54)	31-43 (23-32)

<sup>(1)</sup>Typical all weld metal. <sup>(2)</sup>Measured with 0.2% offset. <sup>(3)</sup>See test results disclaimer

**DEPOSIT COMPOSITION<sup>(1)</sup>**

	%C	%Mn	%Si	%S	%P	Diffusible Hydrogen (mL/100g weld deposit)
<b>Requirements</b> AWS E71T-1M-H8, E71T-9M-H8	0.12 max	1.75 max	0.90 max	0.03 max	0.03 max	8 max
<b>Test Results<sup>(3)</sup></b> As-Welded with 75% Argon / 25% CO <sub>2</sub>	0.04-0.05	1.44-1.50	0.49-0.53	<0.01	0.01	3-7

**TYPICAL OPERATING PROCEDURES**

Diameter, Polarity Shielding Gas	CTWD <sup>(4)</sup> mm (in)	Wire Feed Speed m/min (in/min)	Voltage (Volts)	Approx. Current (Amps)	Melt-Off Rate kg/hr (lb/hr)	Deposition Rate kg/hr (lb/hr)	Efficiency (%)
0.045 in (1.1 mm), DC+ 75% Argon / 25% CO <sub>2</sub>	25 (1)	4.4 (175)	21-26	130	1.8 (4.0)	1.6 (3.5)	87 - 88
		6.4 (250)	22-27	155	2.6 (5.7)	2.3 (5.0)	
		7.6 (300)	23-28	170	3.1 (6.9)	2.7 (6.0)	
		8.9 (350)	23-29	190	3.6 (8.0)	3.2 (7.0)	
		10.2 (400)	25-30	205	4.1 (9.1)	3.6 (8.0)	
		11.4 (450)	26-31	225	4.7 (10.3)	4.1 (9.0)	
		12.7 (500)	27-33	230	5.2 (11.4)	4.5 (9.9)	
		14.0 (550)	28-33	245	5.7 (12.6)	4.9 (10.9)	
15.2 (600)	28-34	265	6.2 (13.7)	5.4 (11.9)			
0.052 in (1.3 mm), DC+ 75% Argon / 25% CO <sub>2</sub>	25 (1)	3.8 (150)	22-26	145	2.0 (4.5)	1.8 (3.9)	87 - 88
		5.1 (200)	23-27	170	2.7 (6.0)	2.4 (5.2)	
		6.4 (250)	23-28	190	3.4 (7.5)	2.9 (6.5)	
		7.6 (300)	24-29	215	4.1 (9.0)	3.5 (7.8)	
		8.9 (350)	24-30	235	4.8 (10.5)	4.1 (9.1)	
		9.5 (375)	25-30	250	5.1 (11.2)	4.4 (9.8)	
		10.8 (425)	26-31	270	5.8 (12.7)	5.0 (11.1)	
		12.1 (475)	26-32	295	6.4 (14.2)	5.6 (12.4)	
12.7 (500)	27-33	305	6.8 (15.0)	5.9 (13.0)			
1/16 in (1.6 mm), DC+ 75% Argon / 25% CO <sub>2</sub>	25 (1)	3.8 (150)	22 - 26	195	2.9 (6.3)	2.5 (5.5)	86 - 87
		4.4 (175)	23 - 26	215	3.4 (7.4)	2.9 (6.4)	
		5.1 (200)	23 - 27	235	3.8 (8.4)	3.3 (7.3)	
		5.7 (225)	24 - 28	255	4.3 (9.5)	3.7 (8.2)	
		6.4 (250)	25 - 29	270	4.8 (10.5)	4.1 (9.1)	
		7.6 (300)	25 - 30	310	5.7 (12.6)	5.0 (11.0)	
		8.3 (325)	26 - 31	330	6.2 (13.7)	5.4 (11.9)	
		8.9 (350)	28 - 32	350	6.7 (14.7)	5.8 (12.8)	
10.2 (400)	28 - 33	390	7.6 (16.8)	6.6 (14.6)			

<sup>(1)</sup>Typical all weld metal. <sup>(2)</sup>Measured with 0.2% offset. <sup>(3)</sup>See test results disclaimer. <sup>(4)</sup>To estimate ESO, subtract 1/4 in. (6.0 mm) from CTWD.

# ULTRACORE® HD-12C

Mild Steel, All Position ■ AWS E71T-12C-JH8, E71T1-C1A4-CS2-H8

## KEY FEATURES

- Increase weld deposition to more than 14 lbs/hr out-of-position
- Fast freezing slag for a flat bead shape and increased productivity in all positions
- Operators can set the machine on a single setting and weld in all positions
- Weld over light rust, mill scale, and primer
- Capable of exceeding 27 J (20 ft•lbf) at -40°C (-40°F)
- ProTech® foil bag packaging

## WELDING POSITIONS

All

## SHIELDING GAS

100% CO<sub>2</sub>

Flow Rate: 40 - 50 CFH

## CONFORMANCES

<b>AWS A5:</b>	E71T1-C1A4-CS2-H8, E71T-12C-JH8, E71T-1C-JH8 E71T-9C-JH8
<b>ABS:</b>	3YSA H10
<b>CWB/CSA:</b>	E491T-12J-H8, E491T1-C1A4-CS2-H8, E491T-9J-H8
<b>DNV:</b>	III YMS H10
<b>Lloyd's Register:</b>	3YS H10
<b>ISO:</b>	T49 4 T12-1 C1 A-K H10

## TYPICAL APPLICATIONS

- Heavy Fabrication
- Mining
- General Fabrication
- Structural
- Applications requiring PWHT of mild steels

## DIAMETERS / PACKAGING

Diameter in (mm)	15 lb (6.8 kg) Plastic Spool 60 lb (27.2 kg) Master Carton	33 lb (15 kg) Fiber Spool
0.045 (1.1)	ED035631	ED034274
0.052 (1.3)	ED035632	ED034275
1/16 (1.6)	ED036295	ED034276

## MECHANICAL PROPERTIES<sup>(1)</sup>

	Yield Strength <sup>(2)</sup> MPa (ksi)	Tensile Strength MPa (ksi)	Elongation %	Charpy V-Notch J (ft•lbf)	
				@ -29°C (-20°F)	@ -40°C (-40°F)
<b>Requirements<sup>(4)</sup></b> AWS A5.20: E71T-12C-JH8 AWS A5.36: E71T1-C1A4-CS2-H8	400 (58) min	480-620 (70-90) 480-660 (70-95)	22 min	-	27 (20) min
<b>Typical Results<sup>(3)</sup></b> As-Welded with 100% CO <sub>2</sub> Stress-Relieved for 1 hr @ 620°C (1150°F)	538 (78) 496 (72)	593 (86) 579 (84)	28 28	93 (68) 58 (43)	51 (38) -

**DEPOSIT COMPOSITION<sup>(1)</sup>**

	%C	%Mn	%Si	%Ni
<b>Requirements<sup>(4)</sup></b> AWS A5.20: E71T-12C-JH8 AWS A5.36: E71T1-C1A4-CS2-H8	0.12 max	1.60 max	0.90 max	0.50 max
<b>Typical Results<sup>(3)</sup></b> As-Welded with 100% CO <sub>2</sub>	0.04	1.35	0.33	0.40
	%S	%P	Diffusible Hydrogen (mL/100g weld deposit)	
<b>Requirements<sup>(4)</sup></b> AWS A5.20: E71T-12C-JH8 AWS A5.36: E71T1-C1A4-CS2-H8	0.03 max 0.030 max	0.03 max 0.030 max	8.0 max 8 max	
<b>Typical Results<sup>(3)</sup></b> As-Welded with 100% CO <sub>2</sub>	0.01	0.01	4-7	

<sup>(1)</sup>Typical all weld metal. <sup>(2)</sup>Measured with 0.2% offset. <sup>(3)</sup>See test results disclaimer. <sup>(4)</sup>As-Welded with 100% CO<sub>2</sub>.

**TYPICAL OPERATING PROCEDURES**

Diameter, Polarity Shielding Gas	CTWD <sup>(5)</sup> mm (in)	Wire Feed Speed m/min (in/min)	Voltage (volts)	Approx. Current (amps)	Melt-Off Rate kg/hr (lb/hr)	Deposition Rate kg/hr (lb/hr)	Efficiency (%)
0.045 in (1.1 mm), DC+ As-Welded with 100% CO <sub>2</sub>	25 (1)	4.4 (175)	24-29	115	1.8 (3.9)	1.5 (3.4)	85-88
		6.4 (250)	25-30	140	2.5 (5.6)	2.2 (4.8)	
		7.6 (300)	26-31	155	3.1 (6.8)	2.6 (5.8)	
		8.9 (350)	26-31	170	3.6 (7.9)	3.1 (6.8)	
		10.2 (400)	26-31	185	4.1 (9.0)	3.5 (7.8)	
		11.4 (450)	27-32	200	4.6 (10.1)	4.0 (8.8)	
		12.7 (500)	27-32	215	5.1 (11.3)	4.4 (9.8)	
		14.0 (550)	28-33	230	5.6 (12.4)	4.9 (10.8)	
0.052 in (1.3 mm), DC+ As-Welded with 100% CO <sub>2</sub>	25 (1)	3.8 (150)	24-29	140	2.1 (4.7)	1.7 (3.8)	85-88
		5.1 (200)	25-30	160	2.9 (6.3)	2.4 (5.2)	
		6.4 (250)	26-31	180	3.5 (7.8)	3.0 (6.5)	
		7.6 (300)	26-31	205	4.3 (9.4)	3.6 (7.9)	
		8.9 (350)	27-32	225	5.0 (11.0)	4.2 (9.2)	
		9.5 (375)	27-32	235	5.3 (11.7)	4.5 (9.9)	
		10.8 (425)	27-32	255	6.0 (13.3)	5.1 (11.2)	
		12.1 (475)	28-33	275	6.8 (14.9)	5.7 (12.6)	
1/16 in (1.6 mm), DC+ As-Welded with 100% CO <sub>2</sub>	25 (1)	3.8 (150)	23-28	200	2.9 (6.4)	2.4 (5.3)	85-88
		4.4 (175)	24-29	215	3.4 (7.5)	2.9 (6.3)	
		5.1 (200)	24-29	230	3.9 (8.5)	3.3 (7.2)	
		5.7 (225)	24-29	245	4.4 (9.6)	3.7 (8.1)	
		6.4 (250)	25-30	255	4.8 (10.6)	4.1 (9.1)	
		7.6 (300)	25-30	285	5.8 (12.7)	4.9 (10.9)	
		8.3 (325)	26-31	300	6.3 (13.8)	5.4 (11.9)	
		8.9 (350)	26-31	310	6.7 (14.8)	5.8 (12.8)	
10.2 (400)	27-32	340	7.7 (16.9)	6.7 (14.7)			

<sup>(1)</sup>Typical all weld metal. <sup>(2)</sup>Measured with 0.2% offset. <sup>(3)</sup>See test results disclaimer <sup>(4)</sup>As-Welded with 100% CO<sub>2</sub>. <sup>(5)</sup>To estimate ESO, subtract 1/4 in (6.0 mm) from CTWD.



# ULTRACORE® HD-12M

Mild Steel, All Position ■ AWS E71T-12M-JH8, E71T1-M21A4-CS2-H8

## KEY FEATURES

- Increase weld deposition up to 14 lbs/hr out-of-position
- Results in a flat bead shape and enhanced productivity in all positions
- Operators can set the machine on a single setting and weld in all positions
- Capable of exceeding 27 J (20 ft•lbf) at -40°C (-40°F)
- ProTech® foil bag packaging

## WELDING POSITIONS

All

## SHIELDING GAS

75-80% Argon / Balance CO<sub>2</sub>  
Flow Rate: 40 - 50 CFH

## CONFORMANCES

<b>AWS A5:</b>	E71T1-M21A4-CS2-H8, E71T-12M-JH8, E71T-1M-JH8, E71T-9M-JH8
<b>ABS:</b>	3Y400SA H10 3YSA H10
<b>CWB/CSA:</b>	E491T-12MJ-H8, E491T1-M21A4-CS2-H8
<b>DNV:</b>	III YMS H10
<b>Lloyd's Register:</b>	3YS H10
<b>ISO:</b>	T49 4 T12-1 M21 A-K H10

## TYPICAL APPLICATIONS

- Heavy Fabrication
- Mining
- General Fabrication

## DIAMETERS / PACKAGING

Diameter in (mm)	15 lb (6.8 kg) Plastic Spool 60 lb (27.2 kg) Master Carton	33 lb (15 kg) Fiber Spool
0.045 (1.1)	ED036180	ED034277
0.052 (1.3)	ED036181	ED034278
1/16 (1.6)	ED036294	ED034279

## MECHANICAL PROPERTIES<sup>(1)</sup>

	Yield Strength <sup>(2)</sup> MPa (ksi)	Tensile Strength MPa (ksi)	Elongation %	Charpy V-Notch J (ft•lbf)	
				@ -29°C (-20°F)	@ -40°C (-40°F)
<b>Requirements<sup>(4)</sup></b> AWS A5.20: E71T-12M-JH8 AWS A5.36: E71T1-M21A4-CS2-H8	400 (58) min	480-620 (70-90) 480-660 (70-95)	22 min	-	27 (20) min
<b>Typical Results<sup>(3)</sup></b> As-Welded with 75% Argon / 25% CO <sub>2</sub> Stress Relieved for 1 hr @ 620°C (1150°F)	538 (78) 503 (73)	600 (87) 593 (86)	26 29	102 (75) 68 (50)	65 (48) -

<sup>(1)</sup>Typical all weld metal. <sup>(2)</sup>Measured with 0.2% offset. <sup>(3)</sup>See test results disclaimer. <sup>(4)</sup>As-Welded with 75-80% Ar / Balance CO<sub>2</sub>.

**DEPOSIT COMPOSITION<sup>(1)</sup>**

	%C	%Mn	%Si	%Ni
<b>Requirements<sup>(4)</sup></b> AWS A5.20: E71T-12M-JH8 AWS A5.36: E71T1-M21A4-CS2-H8	0.12 max	1.60 max	0.90 max	0.50 max
<b>Typical Results<sup>(3)</sup></b> As-Welded with 75% Argon / 25% CO <sub>2</sub>	0.05	1.40	0.39	0.40
	%S	%P	Diffusible Hydrogen (mL/100g weld deposit)	
<b>Requirements<sup>(4)</sup></b> AWS A5.20: E71T-12M-JH8 AWS A5.36: E71T1-M21A4-CS2-H8	0.03 max 0.030 max	0.03 max 0.030 max	8.0 max 8 max	
<b>Typical Results<sup>(3)</sup></b> As-Welded with 75% Argon / 25% CO <sub>2</sub>	0.01	0.01	4-7	

**TYPICAL OPERATING PROCEDURES**

Diameter, Polarity Shielding Gas	CTWD <sup>(5)</sup> mm (in)	Wire Feed Speed m/min (in/min)	Voltage (volts)	Approx. Current (amps)	Melt-Off Rate kg/hr (lb/hr)	Deposition Rate kg/hr (lb/hr)	Efficiency (%)
0.045 in (1.1 mm), DC+ As-Welded with 75% Ar/25% CO <sub>2</sub>	25 (1)	4.4 (175)	23-28	115	1.8 (3.9)	1.5 (3.4)	85-88
		6.4 (250)	24-29	140	2.5 (5.6)	2.2 (4.8)	
		7.6 (300)	25-30	155	3.1 (6.8)	2.6 (5.8)	
		8.9 (350)	25-30	170	3.6 (7.9)	3.1 (6.8)	
		10.2 (400)	25-30	185	4.1 (9.0)	3.5 (7.8)	
		11.4 (450)	26-31	200	4.6 (10.1)	4.0 (8.8)	
		12.7 (500)	26-31	215	5.1 (11.3)	4.4 (9.8)	
		14.0 (550)	27-32	230	5.6 (12.4)	4.9 (10.8)	
0.052 in (1.3 mm), DC+ As-Welded with 75% Ar/25% CO <sub>2</sub>	25 (1)	3.8 (150)	23-28	140	2.1 (4.7)	1.7 (3.8)	85-88
		5.1 (200)	24-29	160	2.9 (6.3)	2.4 (5.2)	
		6.4 (250)	25-30	180	3.5 (7.8)	3.0 (6.5)	
		7.6 (300)	25-30	205	4.3 (9.4)	3.6 (7.9)	
		8.9 (350)	26-31	225	5.0 (11.0)	4.2 (9.2)	
		9.5 (375)	26-31	235	5.3 (11.7)	4.5 (9.9)	
		10.8 (425)	26-31	255	6.0 (13.3)	5.1 (11.1)	
		12.1 (475)	27-32	275	6.8 (14.9)	5.7 (12.6)	
1/16 in (1.6 mm), DC+ As-Welded with 75% Ar/25% CO <sub>2</sub>	25 (1)	3.8 (150)	22-27	200	2.9 (6.4)	2.4 (5.3)	85-88
		4.4 (175)	23-28	215	3.4 (7.5)	2.9 (6.3)	
		5.1 (200)	23-28	230	3.9 (8.5)	3.3 (7.2)	
		5.7 (225)	23-28	245	4.4 (9.6)	3.7 (8.1)	
		6.4 (250)	24-29	255	4.8 (10.6)	4.1 (9.1)	
		7.6 (300)	24-29	285	5.8 (12.7)	4.9 (10.9)	
		8.3 (325)	25-30	300	6.3 (13.8)	5.4 (11.9)	
		8.9 (350)	25-30	310	6.7 (14.8)	5.8 (12.8)	
10.2 (400)	26-31	340	7.7 (16.9)	6.7 (14.7)			

<sup>(1)</sup>Typical all weld metal. <sup>(2)</sup>Measured with 0.2% offset. <sup>(3)</sup>See test results disclaimer <sup>(4)</sup>As-Welded with 75-80% Ar / Balance CO<sub>2</sub>. <sup>(5)</sup>To estimate ESO, subtract 1/4 in (6.0 mm) from CTWD.

# ULTRACORE® HD MARINE

Mild Steel, All Positions ▪ AWS E71T-9C-H8, E71T1-C1A2-CS1-H8

## KEY FEATURES

- Excellent operator appeal with minimal spatter and low fume generation rates
- High deposition rates up to 12 lbs/hr out-of-position
- Fast freezing slag for a flat bead shape and increased productivity
- Weld in all positions with one setting
- ProTech® foil bag packaging

## WELDING POSITIONS

All

## CONFORMANCES

- AWS A5:** E71T1-C1A2-CS1-H8, E71T-1C-H8, E71T-9C-H8
- ABS:** 2Y400SA H10 2YSA H10
- DNV:** II YMS H10
- Lloyd's Register:** 2YS H10
- BV:** SA2Y H10

## TYPICAL APPLICATIONS

- Shipbuilding
- General Fabrication

## SHIELDING GAS

100% CO<sub>2</sub>  
Flow rate: 40-50 CFH

## DIAMETERS / PACKAGING

Diameter in (mm)	15 lb (6.8 kg) Plastic Spool 60 lb (27.2 kg) Master Carton	33 lb (15 kg) Fiber Spool
0.052 (1.3)	ED035743	ED036323
1/16 (1.6)	ED035778	ED036324

## MECHANICAL PROPERTIES<sup>(1)</sup>

	Yield Strength <sup>(2)</sup> MPa (ksi)	Tensile Strength MPa (ksi)	Elongation (%)	Charpy V-Notch J (ft-lbf)	
				@-18°C (0°F)	@-29°C (-20°F)
<b>Requirements</b>					
AWS A5.20: E71T-1C-H8, E71T-9C-H8	400 (58) min	480-655 (70-95)	22 min	27 (20) min	27 (20) min
AWS A5.36: E71T1-C1A2-CS1-H8				-	
<b>Typical Results<sup>(3)</sup></b>					
As-Welded with 100% CO <sub>2</sub>	580-615 (84-89)	630-655 (92-95)	27	87-96 (64-71)	49-58 (36-43)

<sup>(1)</sup> Typical all weld metal. <sup>(2)</sup> Measured with 0.2% offset. <sup>(3)</sup> See test results disclaimer

**DEPOSIT COMPOSITION<sup>(1)</sup>**

	%C	%Mn	%Si	%S
<b>Requirements</b> AWS A5.20: E71T-1C-H8,E71T-9C-H8	0.12 max	1.75 max	0.90 max	0.03 max
AWS A5.36: E71T1-C1A2-CS1-H8				0.030 max
<b>Typical Results<sup>(3)</sup></b> As-Welded with 100% CO <sub>2</sub>	0.04-0.05	1.59-1.70	0.36-0.40	0.01
	%P	%Ni	Diffusible Hydrogen (ml/100g weld deposit)	
<b>Requirements</b> AWS A5.20: E71T-1C-H8,E71T-9C-H8	0.03 max	0.50 max	8.0 max	
AWS A5.36: E71T1-C1A2-CS1-H8	0.030 max		8 max	
<b>Typical Results<sup>(3)</sup></b> As-Welded with 100% CO <sub>2</sub>	0.016	0.02	3.1-4.1	

**TYPICAL OPERATING PROCEDURES**

Diameter, Polarity Shielding Gas	CTWD <sup>(4)</sup> mm (in)	Wire Feed Speed m/min (in/min)	Voltage (Volts)	Approx. Current (amps)	Melt-Off Rate kg/hr (lb/hr)	Deposition Rate kg/hr (lb/hr)	Efficiency (%)
0.052 in (1.3mm), DC+, 100% CO <sub>2</sub>	19-25 (3/4-1)	3.8 (150)	22-25	140	2.0 (4.5)	1.7 (3.7)	81-85
		5.1 (200)	23-26	175	2.6 (5.8)	2.2 (4.9)	
		6.4 (250)	23-27	210	3.4 (7.4)	2.8 (6.2)	
		7.6 (300)	24-29	230	4.0 (8.8)	3.4 (7.4)	
		8.9 (350)	26-30	255	4.6 (10.2)	3.9 (8.7)	
		9.5 (375)	27-30	275	5.0 (11.1)	4.3 (9.4)	
		10.2 (400)	29-31	280	5.4 (11.9)	4.5 (9.9)	
		12.1 (475)	29-33	295	6.5 (14.3)	5.5 (12.2)	
1/16 in (1.6mm), DC+, 100% CO <sub>2</sub>	19-25 (3/4-1)	3.8 (150)	23-26	185	2.9 (6.3)	2.4 (5.3)	83-87
		4.4 (175)	23-27	220	3.3 (7.3)	2.8 (6.1)	
		5.1 (200)	23-27	240	3.8 (8.3)	3.2 (7.1)	
		5.7 (225)	23-28	260	4.2 (9.2)	3.7 (8.2)	
		6.4 (250)	24-29	275	4.7 (10.4)	4.3 (9.4)	
		7.6 (300)	25-30	315	5.6 (12.4)	4.8 (10.6)	
		8.3 (325)	27-31	325	6.1 (13.5)	5.3 (11.7)	
		8.9 (350)	27-31	335	6.7 (14.7)	5.8 (12.7)	
9.5 (400)	28-32	360	7.7 (16.9)	6.6 (14.5)			

<sup>(1)</sup>Typical all weld metal. <sup>(2)</sup>Measured with 0.2% offset. <sup>(3)</sup>See test results disclaimer. <sup>(4)</sup>To estimate ESO, subtract 1/4 in (6.0 mm) from CTWD.

# OUTERSHIELD® 71M

Mild Steel, All Position ■ AWS E71T-9C-J, E71T-9M-J, E71T1-C1A4-CS1-H16, E71T1-M21A4-CS1-H16

## KEY FEATURES

- Dual classified for both 100% CO<sub>2</sub> and 75% Argon / 25% CO<sub>2</sub> mixed gas
- Exceeds impact requirements at -40°C (-40°F)
- High travel speeds
- Spray like transfer with minimal spatter
- Rod based manufacturing for industry leading wire stiffness and feedability
- Increased rigidity allows for easy manual break-off

## SHIELDING GAS

100% CO<sub>2</sub>  
75% Argon / 25% CO<sub>2</sub>  
Flow Rate: 40 - 50 CFH

## WELDING POSITIONS

All, except vertical down

## DIAMETERS / PACKAGING

Diameter in (mm)	10 lb (4.5 kg) Plastic Spool	25 lb (11.3 kg) Plastic Spool	33 lb (15 kg) Steel Spool	50 lb (22.7 kg) Coil
0.035 (0.9)	ED026804	ED026805		
0.045 (1.1)	ED020836	ED022659	ED030007	ED020844
0.052 (1.3)		ED022660	ED030008	ED020845
1/16 (1.6)		ED022661	ED030009	ED020846
Diameter in (mm)	300 lb (136 kg) Speed-Feed® Reel	500 lb (227 kg) Accu-Trak® Drum	600 lb (272 kg) Speed-Feed® Reel	
0.035 (0.9)				
0.045 (1.1)		ED027364		
0.052 (1.3)		ED029778		
1/16 (1.6)	ED020848	ED029779	ED020851	

## MECHANICAL PROPERTIES<sup>(1)</sup>

	Yield Strength <sup>(2)</sup> MPa (ksi)	Tensile Strength MPa (ksi)	Elongation %	Charpy V-Notch J (ft-lbf)		
				@ -18°C (0°F)	@ -29°C (-20°F)	@ -40°C (-40°F)
<b>Requirements</b> AWS E71T-1C-J / E71T-1M-J AWS E71T-9C-J / E71T-9M-J	400 (58) min	480-655 (70-95)	22 min	27 (20) min -	- 27 (20) min	27 (20) min <sup>(a)</sup> 27 (20) min <sup>(a)</sup>
<b>Test Results<sup>(3)</sup></b> As-Welded with 100% CO <sub>2</sub> and 75% Argon/25% CO <sub>2</sub>	500-570 (72-83)	560-630 (81-91)	27-29	176-190 (130-140)	176-190 (130-140)	130-163 (96-120)

<sup>(a)</sup>Electrodes with the optional supplemental designator "J" shall meet the minimum Charpy V-Notch impact energy requirement for its classification at a test temperature of 10°C lower than the test temperature for its classification.

## CONFORMANCES

<b>AWS A5:</b>	E71T1-C1A4-CS1-H16, E71T1-M21A4-CS1-H16, E71T-1C-JH16, E71T-1M-JH16, E71T-9C-JH16, E71T-9M-JH16
<b>ABS:</b>	3YSA H15
<b>CWB/CSA:</b>	E491T1-C1A4-CS1-H16, E491T1-M21A4-CS1-H16, E491T-9J-H16, E491T-9MJ-H16
<b>DNV:</b>	III YMS H10
<b>Lloyd's Register:</b>	3YS H15
<b>BV:</b>	SA3YH
<b>ISO:</b>	T49 4 T1-1, C1 A H15, T49 4 T1-1, M21 A H15

## TYPICAL APPLICATIONS

- Bridge, ship, & barge
- Structural fabrication
- General fabrication
- Offshore applications
- Machinery fabrication

**DEPOSIT COMPOSITION<sup>(1)</sup>**

	%C	%Mn	%Si	%S	%P
<b>Requirements</b> AWS E71T-1C-J / E71T-1M-J AWSE71T-9C-J / E71T-9M-J	0.12 max	1.75 max	0.90 max	0.03 max	0.03 max
<b>Test Results<sup>(3)</sup></b> As-Welded with 100% CO <sub>2</sub> and 75% Argon/25% CO <sub>2</sub>	0.05-0.07	1.04-1.60	0.25-0.50	≤ 0.01	< 0.01

**TYPICAL OPERATING PROCEDURES**

Diameter, Polarity Shielding Gas <sup>(4)</sup>	CTWD <sup>(5)</sup> mm (in)	Wire Feed Speed m/min (in/min)	Voltage (volts)	Approx. Current (amps)	Melt-Off Rate kg/hr (lb/hr)	Deposition Rate kg/hr (lb/hr)	Efficiency (%)
0.035 in (0.9 mm), DC+ 100% CO <sub>2</sub>	19-25 (3/4-1)	5.1 (200)	20-23	95	1.3 (2.8)	1.1 (2.8)	85
		6.4 (250)	21-24	115	1.6 (3.5)	1.4 (3.5)	85
		7.6 (300)	22-25	130	1.9 (4.2)	1.6 (4.2)	86
		8.9 (350)	23-26	150	2.2 (4.9)	1.9 (4.9)	86
		10.2 (400)	24-27	160	2.6 (5.6)	2.2 (5.6)	86
		12.7 (500)	26-29	185	3.2 (7.0)	2.7 (7.0)	86
		15.2 (600)	28-31	200	3.8 (8.4)	3.3 (8.4)	86
		17.8 (700)	30-33	215	4.4 (9.8)	3.8 (9.8)	86
0.045 in (1.1 mm), DC+ 100% CO <sub>2</sub>	19-25 (3/4-1)	5.1 (200)	23-26	165	2.1 (4.6)	1.8 (3.9)	83
		6.4 (250)	24-27	190	2.6 (5.8)	2.2 (4.8)	84
		7.6 (300)	25-28	220	3.1 (6.9)	2.6 (5.8)	84
		8.9 (350)	26-29	245	3.7 (8.1)	3.1 (6.8)	84
		10.2 (400)	26-29	265	4.2 (9.2)	3.5 (7.8)	84
		12.7 (500)	28-31	295	5.2 (11.5)	4.4 (9.7)	84
		15.2 (600)	30-33	315	6.3 (13.8)	5.3 (11.7)	85
		17.8 (700)	32-35	325	7.3 (16.1)	6.2 (13.7)	85
0.052 in (1.3 mm), DC+ 100% CO <sub>2</sub>	19-25 (3/4-1)	3.8 (150)	22-25	150	2.1 (4.7)	1.7 (3.8)	81
		5.1 (200)	23-26	180	2.8 (6.2)	2.3 (5.1)	83
		6.4 (250)	24-27	210	3.5 (7.7)	2.9 (6.5)	83
		7.6 (300)	25-28	235	4.2 (9.3)	3.5 (7.8)	84
		8.9 (350)	27-30	265	4.9 (10.8)	4.2 (9.1)	84
		11.4 (450)	29-32	305	6.3 (13.9)	5.4 (11.8)	85
		12.7 (500)	30-33	325	7.0 (15.5)	6.0 (13.2)	85
		15.2 (600)	33-36	360	8.4 (18.6)	7.2 (15.8)	85
1/16 in (1.6 mm), DC+ 100% CO <sub>2</sub>	19 (3/4)	3.2 (125)	23-26	205	2.5 (5.4)	2.0 (4.5)	82
		3.8 (150)	24-27	225	3.0 (6.5)	2.4 (5.4)	82
		5.1 (200)	25-28	260	4.0 (8.7)	3.3 (7.2)	83
		6.4 (250)	26-29	295	4.9 (10.9)	4.1 (9.1)	83
		7.6 (300)	28-31	330	5.9 (13.0)	5.0 (10.9)	84
	25 (1)	10.2 (400)	30-33	395	7.9 (17.4)	6.6 (14.6)	84
		12.7 (500)	33-36	445	9.9 (21.7)	8.3 (18.3)	84

<sup>(1)</sup>Typical all weld metal. <sup>(2)</sup>Measured with 0.2% offset. <sup>(3)</sup>See test results disclaimer <sup>(4)</sup>When welding under mixed gas, decrease voltage. <sup>(5)</sup>To estimate ESO, subtract 1/4 in (6.0 mm) from CTWD.  
NOTE: This product contains micro-alloying elements.

# OUTERSHIELD® 71 ELITE

Mild Steel, All Position ■ AWS E71T-9C-H8, E71T-9M-H8, E71T1-C1A2-CS1-H8, E71T1-M21A2-CS1-H8

## KEY FEATURES

- Smooth arc transfer and low spatter
- Designed for welding with either 100% CO<sub>2</sub> or 75-82% Argon/balance CO<sub>2</sub> shielding gases
- Good bead appearance
- Fast freezing slag for out-of-position welding
- Meets AWS D1.8 seismic lot waiver requirements

## WELDING POSITIONS

All

## SHIELDING GAS

100% CO<sub>2</sub>  
 75 - 82% Argon / Balance CO<sub>2</sub>  
 Flow Rate: 40 - 50 CFH

## CONFORMANCES

- AWS A5:** E71T1-C1A2-CS1-H8, E71T1-M21A2-CS1-H8, E71T-1C-H8, E71T-1M-H8, E71T-9C-H8, E71T-9M-H8
- ABS:** 3YSA H10
- CWB/CSA:** E491T-9-H8, E491T-9M-H8
- DNV:** III YMS H10
- Lloyd's Register:** 3YS H10
- AWS D1.8:** 0.052", 1/16"

## TYPICAL APPLICATIONS

- Shipbuilding, barges and offshore platforms
- Heavy equipment
- Structural fabrication
- General fabrication

## DIAMETERS / PACKAGING

Diameter in (mm)	15 lb (6.8 kg) Plastic Spool 60 lb (27.2 kg) Master Carton	33 lb (15 kg) Steel Spool	60 lb (27.2 kg) Coil	600 lb (272 kg) Accu-Trak® Drum
0.045 (1.1)	ED029418	ED029201	ED029202	ED029387
0.052 (1.3)	ED029419	ED029204	ED029205	
1/16 (1.6)		ED029206	ED029207	

## MECHANICAL PROPERTIES<sup>(1)</sup>

	Yield Strength <sup>(2)</sup> MPa (ksi)	Tensile Strength MPa (ksi)	Elongation %	Charpy V-Notch J (ft•lbf)	
				@ -18°C (0°F)	@ -29°C (-20°F)
<b>Requirements</b> AWS E71T-1C-H8, E71T-9C-H8 AWS E71T-1M-H8, E71T-9M-H8	400 (58) min	485-655 (70-95)	22 min	27 (20) min -	- 27 (20) min
<b>Typical Results<sup>(3)</sup></b> As-Welded with 100% CO <sub>2</sub> As-Welded with 75% Ar/25% CO <sub>2</sub>	545-565 (79-82) 585-595 (85-87)	585-615 (85-90) 625-630 (91-92)	28 25-28	74-83 (55-61) 92-99 (68-73)	58-64 (43-47) 70-83 (52-61)

**DEPOSIT COMPOSITION<sup>(1)</sup>**

	%C	%Mn	%Si	%S	%P
<b>Requirements</b> AWS E71T-1C-H8, E71T-9C-H8 AWS E71T-1M-H8, E71T-9M-H8	0.12 max	1.75 max	0.90 max	0.03 max	0.03 max
<b>Typical Results<sup>(3)</sup></b> As-Welded with 100% CO <sub>2</sub> As-Welded with 75% Ar/25% CO <sub>2</sub>	0.01-0.04 0.02-0.04	1.41-1.50 1.55-1.65	0.44-0.60 0.56-0.75	≤0.01 ≤0.01	≤0.01 ≤0.01

**TYPICAL OPERATING PROCEDURES**

Diameter, Polarity Shielding Gas <sup>(4)</sup>	CTWD <sup>(5)</sup> mm (in)	Wire Feed Speed m/min (in/min)	Voltage (volts)	Approx. Current (amps)	Melt-Off Rate kg/hr (lb/hr)	Deposition Rate kg/hr (lb/hr)	Efficiency (%)
0.045 in (1.1 mm), DC+ 75% Ar / 25% CO <sub>2</sub>	19 (3/4)	4.5 (175)	21-24	130	1.7 (3.8)	1.5 (3.3)	87
		6.4 (250)	23-26	155	2.4 (5.4)	2.1 (4.7)	87
		7.6 (300)	24-27	180	2.9 (6.4)	2.5 (5.6)	87
		8.9 (350)	25-28	205	3.4 (7.6)	3.0 (6.6)	87
		10.2 (400)	26-29	230	4.0 (8.7)	3.5 (7.6)	87
		12.8 (500)	27-30	260	5.0 (10.9)	4.3 (9.5)	87
		15.3 (600)	28-31	290	6.0 (13.1)	5.2 (11.4)	87
0.052 in (1.3 mm), DC+ 75% Ar / 25% CO <sub>2</sub>	19 (3/4)	3.8 (150)	21-24	150	2.1 (4.6)	1.8 (3.9)	86
		5.1 (200)	22-25	180	2.8 (6.1)	2.4 (5.2)	86
		6.4 (250)	23-26	210	3.4 (7.6)	3.0 (6.5)	86
		7.6 (300)	24-27	240	4.8 (10.6)	4.1 (7.8)	86
		10.2 (400)	26-28	315	6.2 (13.7)	5.4 (10.5)	86
		12.8 (500)	28-31	335	6.9 (15.2)	6.0 (13.1)	86
1/16 (1.6 mm), DC+ 75% Ar / 25% CO <sub>2</sub>	19 (3/4)	3.2 (125)	21-24	190	2.4 (5.2)	2.0 (4.4)	85
		3.8 (150)	22-25	205	2.8 (6.2)	2.4 (5.3)	85
		5.1 (200)	22-26	240	3.8 (8.3)	3.2 (7.0)	85
		6.4 (250)	23-27	290	4.7 (10.3)	4.0 (8.8)	85
		7.6 (300)	24-28	325	5.6 (12.4)	4.8 (10.5)	85
		10.2 (400)	27-31	400	7.5 (16.5)	6.4 (14.0)	85

<sup>(1)</sup>Typical all weld metal. <sup>(2)</sup>Measured with 0.2% offset. <sup>(3)</sup>See test results disclaimer <sup>(4)</sup>When welding under CO<sub>2</sub> increase voltage by 1 Volt. <sup>(5)</sup>To estimate ESO, subtract 1/4 in (6.0 mm) from CTWD.



# OUTERSHIELD® 71 SUPREME

Mild Steel, All Position ■ AWS E71T-1C-H4, E71T-9C-H4, E71T-1M-H4, E71T-9M-H4



## KEY FEATURES

- Designed to be used with either 100% CO<sub>2</sub> or 75% Argon/25% CO<sub>2</sub> gas
- Smooth, consistent arc performance
- The finished weld exhibits an extremely smooth bead appearance, even on out-of-position welds
- Meets H4 diffusible hydrogen levels

## WELDING POSITIONS

All

## SHIELDING GAS

75% Argon/25% CO<sub>2</sub>  
 100% CO<sub>2</sub>  
 Flow Rate: 40 - 50 CFH

## CONFORMANCES

**AWS A5:** E71T-1C-H4, E71T-1M-H4, E71T-9C-H4, E71T-9M-H4

## TYPICAL APPLICATIONS

- Mining
- Offshore
- Bridge fabrication
- High strength fabrication
- Structural steel

## NOTE

- This product is only sold in Canada.
- This product contains micro-alloying elements.
- Additional information available upon request.

## DIAMETERS / PACKAGING

Diameter in. mm	33 lb (15 kg) Spool	500 lb (227 kg) Accu-Trak® Drum	600 lb (272 kg) Accu-Trak® Drum
0.045 (1.1)	ED503040	ED503046*	
0.052 (1.3)	ED503041	ED503047*	
1/16 (1.6)	ED503042		ED503048*

\*Made to order (MTO)

## MECHANICAL PROPERTIES<sup>(1)</sup> – As Required per CSA W48.06

	Yield Strength <sup>(2)</sup> MPa (ksi)	Tensile Strength MPa (ksi)	Elongation %	Charpy V-Notch J (ft·lbf) @ -29°C (-20°F)
<b>Requirements</b> CWB E491T-9-H4, E491T-9M-H4	400 (58) min	485-655 (70-95)	22 min	27 (20) min
<b>Typical Results<sup>(3)</sup></b> As-Welded with 100% CO <sub>2</sub>	520-593 (75-86)	580-640 (84-93)	26-28	49-98 (36-72)
As-Welded with 75% Ar/25% CO <sub>2</sub>	560-646 (81-94)	510-699 (88-101)	25-28	102-126 (75-93)

**DEPOSIT COMPOSITION<sup>(1)</sup> – As Required per CSA W48.06**

	%C	%Mn	%Si	%S	%P	%Ni
<b>Requirements</b> CWB E491T-9-H4, E491T-9M-H4	0.18 max	1.75 max	0.09 max	0.03 max	0.03 max	0.50 max
<b>Test Results<sup>(3)</sup></b> As-Welded with 100% CO <sub>2</sub>	0.04-0.05	1.29-1.43	0.43-0.49	0.01	0.01	0.02-0.03
As-Welded with 75%Ar/25% CO <sub>2</sub>	0.03-0.05	1.45-1.64	0.54-0.68	0.01	0.01	0.02-0.03
	%Cr	%Mo	%V	%Cu	Diffusible Hydrogen (ml/100g weld deposit)	
<b>Requirements</b> CWB E491T-9-H4, E491T-9M-H4	0.20 max	0.30 max	0.08 max	0.35 max	4.0 max	
<b>Test Results<sup>(3)</sup></b> As-Welded with 100% CO <sub>2</sub>	0.04-0.05	0.02-0.03	0.03	0.04-0.10	3-4	
As-Welded with 75%Ar/25% CO <sub>2</sub>	0.04-0.05	0.02	0.03-0.04	0.04-0.08	3-4	

**TYPICAL OPERATING PROCEDURES – All Position**

Diameter, Polarity Shielding Gas <sup>(4)</sup>	CTWD <sup>(5)</sup> mm (in)	Wire Feed Speed m/min (in/min)	Voltage (volts)	Approx. Current (amps)	Melt-Off Rate kg/hr (lb/hr)	Deposition Rate kg/hr (lb/hr)	Efficiency (%)
0.045 in (1.1 mm), DC+ 75% Ar / 25% CO <sub>2</sub>	25 (1)	4.4-12.7 (175-500)	22-28	125-260	2.0-5.2 (4.5-11.3)	1.8-4.6 (4.0-10.05)	86-88
0.052 in (1.3 mm), DC+ 75% Ar / 25% CO <sub>2</sub>	25 (1)	3.8-10.2 (150-400)	22-31	135-295	2.1-5.4 (4.6-12.0)	1.8-4.9 (4.0-10.07)	86-88
1/16 (1.6 mm), DC+ 75% Ar / 25% CO <sub>2</sub>	25 (1)	3.8-8.9 (150-350)	23-31	135-365	2.9-6.7 (6.4-14.7)	2.5-5.9 (5.6-13.1)	86-88

<sup>(1)</sup>Typical all weld metal. <sup>(2)</sup>Measured with 0.2% offset. <sup>(3)</sup>See test results disclaimer. <sup>(4)</sup>When welding under CO<sub>2</sub> increase voltage by 1 Volt. <sup>(5)</sup>To estimate ESO, subtract 1/4 in (6.0 mm) from CTWD.

# ULTRACORE® 70C

Mild Steel, Flat & Horizontal ■ AWS E70T-9C-H8, E70T1-C1A2-CS1-H8

## KEY FEATURES

- High deposition in the flat and horizontal positions
- Low fume generation rates
- Designed for welding with 100% CO<sub>2</sub> shielding gas
- Premium arc performance and bead appearance
- ProTech® foil bag packaging

## WELDING POSITIONS

Flat & Horizontal

## SHIELDING GAS

100% CO<sub>2</sub>  
Flow Rate: 40-55 CFH

## CONFORMANCES

<b>AWS A5:</b>	E70T1-C1A2-CS1-H8, E70T-1C-H8, E70T-9C-H8
<b>ABS:</b>	2YSA H10
<b>CWB/CSA:</b>	E491T1-M21A2-CS1-H8
<b>AWS D1.8:</b>	1/16", 5/64", 3/32"
<b>ISO:</b>	T49 3 T1-0 C1 A H10

## TYPICAL APPLICATIONS

- Structural fabrication
- Heavy equipment
- Shipbuilding

## DIAMETERS / PACKAGING

Diameter in (mm)	50 lb (22.7 kg) Coil	500 lb (227 kg) Accu-Trak® Drum	500 lb (227 kg) Speed-Feed® Drum
1/16 (1.6)	ED032978	ED033064	ED033065 ED033066
5/64 (2.0)	ED032977		
3/32 (2.4)	ED032941		

## MECHANICAL PROPERTIES<sup>(1)</sup>

	Yield Strength <sup>(2)</sup> MPa (ksi)	Tensile Strength MPa (ksi)	Elongation %	Charpy V-Notch J (ft·lbf)	
				@ -18 °C (0 °F)	@ -29 °C (-20 °F)
<b>Requirements<sup>(4)</sup></b> AWS A5.20 E70T-1C-H8, E70T-9C-H8	400 (58) min	480-655 (70-95)	22 min	27 (20) min	27 (20) min
AWS A5.36 E70T1-C1A2-CS1-H8				-	
<b>Typical Results<sup>(3)</sup></b> As-Welded with 100% CO <sub>2</sub>	485-520 (70-75)	555-590 (81-86)	28-30	47-72 (35-53)	28-47 (21-35)

<sup>(1)</sup>Typical all weld metal. <sup>(2)</sup>Measured with 0.2% offset. <sup>(3)</sup>See test results disclaimer <sup>(4)</sup>As-Welded with 100% CO<sub>2</sub>

**DEPOSIT COMPOSITION<sup>(1)</sup>**

	%C	%Mn	%Si	%S	%P	Diffusible Hydrogen (mL/100g weld deposit)
<b>Requirements<sup>(4)</sup></b>						
AWS A5.20 E70T-1C-H8, E70T-9C-H8	0.12 max	1.75 max	0.90 max	0.03 max	0.03 max	8.0 max
AWS A5.36 E70T1-C1A2-CS1-H8				0.030 max	0.030 max	8 max
<b>Typical Results<sup>(3)</sup></b>						
As-Welded with 100% CO <sub>2</sub>	0.04-0.05	1.46-1.59	0.54-0.59	≤ 0.01	≤ 0.01	5-8

**TYPICAL OPERATING PROCEDURES – Flat & Horizontal**

Diameter, Polarity Shielding Gas	CTWD <sup>(2)</sup> mm (in)	Wire Feed Speed m/min (in/min)	Voltage (volts)	Approx. Current (amps)	Melt-Off Rate kg/hr (lb/hr)	Deposition Rate kg/hr (lb/hr)	Efficiency (%)
1/16 in (1.6 mm), DC+ 100% CO <sub>2</sub>	25 (1)	3.2 (125)	23-27	170	2.4 (5.3)	2.1 (4.7)	84 - 89
		5.1 (200)	24-28	225	3.8 (8.4)	3.2 (7.1)	
		6.4 (250)	25-30	260	4.8 (10.5)	4.1 (9.0)	
		7.6 (300)	27-31	280	5.7 (12.6)	4.9 (10.8)	
		9.5 (375)	28-32	320	7.1 (15.7)	6.1 (13.5)	
5/64 in (2.0 mm), DC+ 100% CO <sub>2</sub>	25 (1)	3.2 (125)	23-27	230	3.8 (8.4)	3.2 (7.1)	84 - 88
		4.4 (175)	24-29	305	5.4 (11.8)	4.6 (10.1)	
		5.7 (225)	25-30	365	6.8 (15.0)	5.9 (13.0)	
		6.4 (250)	26-32	385	7.7 (16.9)	6.5 (14.3)	
		7.6 (300)	27-33	420	9.0 (19.8)	7.8 (17.2)	
3/32 in (2.4 mm), DC+ 100% CO <sub>2</sub>	25 (1)	3.2 (125)	26-33	350	5.4 (11.9)	4.7 (10.3)	87 - 89
		5.1 (200)	27-34	500	8.6 (19.0)	7.6 (16.7)	
	31 (1 1/4)	6.4 (250)	29-35	570	10.6 (23.3)	9.4 (20.8)	
		7.6 (300)	31-37	630	13.1 (28.8)	11.4 (25.1)	
		8.3 (325)	32-38	720	14.3 (31.5)	12.4 (27.2)	

<sup>(1)</sup>Typical all weld metal. <sup>(2)</sup>Measured with 0.2% offset. <sup>(3)</sup>See test results disclaimer <sup>(4)</sup>As-Welded with 100% CO<sub>2</sub>. <sup>(5)</sup>To estimate ESO, subtract 1/4 in (6.0 mm) from CTWD.

# ULTRACORE® 70M

Mild Steel, Flat & Horizontal ■ AWS E70T-9M-H8, E70T1-M21A2-CS1-H8

## KEY FEATURES

- High deposition in the flat and horizontal positions
- Designed for welding with 75-80% Argon / Balance CO<sub>2</sub> shielding gas
- Low fume generation rates
- Excellent operator appeal and slag detachability
- ProTech® foil bag packaging
- Flat bead profile for excellent bead stacking

## WELDING POSITIONS

Flat & Horizontal

## CONFORMANCES

- AWS A5:** E70T1-M21A2-CS1-H8, E70T-1M-H8, E70T-9M-H8
- CWB/CSA:** E490T1-M21A2-CS1-H8, E490T1-M21A3-CS1-H8, E492T-1M-H8, E492T-9M-H8

## TYPICAL APPLICATIONS

- Structural fabrication
- Heavy equipment
- Shipbuilding

## SHIELDING GAS

75-80% Argon / Balance CO<sub>2</sub>  
Flow Rate: 45-55 CFH

## DIAMETERS / PACKAGING

Diameter in (mm)	50 lb ( 22.7kg) Coil	500 lb (227 kg) Accu-Trak® Drum	500 lb (227 kg) Speed-Feed® Drum
1/16 (1.6)	ED035847	ED036638	
5/64 (2.0)	ED035848		ED036637
3/32 (2.4)	ED035849		ED036636

## MECHANICAL PROPERTIES<sup>(1)</sup>

	Yield Strength <sup>(2)</sup> MPa (ksi)	Tensile Strength MPa (ksi)	Elongation %	Charpy V-Notch J (ft•lbf) @ -29°C (-20°F)
<b>Requirements<sup>(4)</sup></b> AWS A5.20 E70T-1M-H8, E70T-9M-H8	400 (58) min	480-655 (70-95)	22 min	27 (20) min
AWS A5.36 E70T1-M21A2-CS1-H8				
<b>Typical Results<sup>(3)</sup></b> As-Welded with 75% Ar/ 25% CO <sub>2</sub>	575-580 (83-84)	635-660 (92-95)	25-27	39-121 (29-89)

<sup>(1)</sup>Typical all weld metal. <sup>(2)</sup>Measured with 0.2% offset. <sup>(3)</sup>See test results disclaimer <sup>(4)</sup>As-Welded with 75%-80% Ar/ Balance% CO<sub>2</sub>

**DEPOSIT COMPOSITION<sup>(1)</sup>**

	%C	%Mn	%Si	%S	%P
<b>Requirements<sup>(4)</sup></b> AWS A5.20 E70T-1M-H8, E70T-9M-H8	0.12 max	1.75 max	0.90 max	0.03 max	0.03 max
AWS A5.36 E70T1-M21A2-CS1-H8				0.030 max	0.030 max
<b>Typical Results<sup>(3)</sup></b> As-Welded with 75% Ar/ 25% CO <sub>2</sub>	0.06-0.07	1.53-1.56	0.58-0.60	0.009	0.013
	%Ni	%Mo	%Cr	%V	Diffusible Hydrogen (mL/100g weld deposit)
<b>Requirements<sup>(4)</sup></b> AWS A5.20 E70T-1M-H8, E70T-9M-H8	0.50 max	0.30 max	0.20 max	0.08 max	8.0 max
AWS A5.36 E70T1-M21A2-CS1-H8					8 max
<b>Typical Results<sup>(3)</sup></b> As-Welded with 75% Ar/ 25% CO <sub>2</sub>	0.03	0.01	0.07	0.03	4-7

**TYPICAL OPERATING PROCEDURES – Flat & Horizontal**

Diameter, Polarity Shielding Gas	CTWD <sup>(5)</sup> mm (in)	Wire Feed Speed m/min (ipm)	Voltage (volts)	Approx. Current (amps)	Melt-Off Rate kg/hr (lb/hr)	Deposition Rate kg/hr (lb/hr)	
1/16 in (1.6 mm), DC+ 75-80% Argon / Balance CO <sub>2</sub>	25 (1)	3.2 (125)	22-26	160	2.2 (4.8)	2.0 (4.4)	
		6.4 (250)	24-28	260	4.5 (9.9)	4.0 (8.8)	
		9.5 (375)	27-31	345	6.8 (14.9)	6.0 (13.2)	
5/64 in (2.0 mm), DC+ 75-80% Argon / Balance CO <sub>2</sub>	25 (1)	3.2 (125)	22-26	255	3.7 (8.1)	3.2 (7.1)	
		5.7 (225)	24-28	380	6.6 (14.6)	5.6 (12.4)	
3/32 in (2.4 mm), DC+ 75-80% Argon / Balance CO <sub>2</sub>	31 (1 1/4)	8.3 (325)	26-31	415	8.9 (19.5)	7.5 (16.4)	
		25 (1)	3.2 (125)	26-30	340	5.1 (11.3)	4.7 (10.3)
		31 (1 1/4)	5.1 (200)	27-32	450	8.3 (18.3)	7.4 (16.3)
		6.4 (250)	30-36	615	12.5 (27.5)	10.7 (23.6)	

<sup>(1)</sup>Typical all weld metal. <sup>(2)</sup>Measured with 0.2% offset. <sup>(3)</sup>See test results disclaimer. <sup>(4)</sup>As-Welded with 75%-80% Ar/ Balance% CO<sub>2</sub>. <sup>(5)</sup>To estimate ESO, subtract 1/4 in (6.0 mm) from CTWD.

# ULTRACORE® 75C

Mild Steel, Flat & Horizontal ■ AWS E70T-5C-JH4, E70T5-C1A4-CS1-H4

## KEY FEATURES

- Basic slag system offers improved crack resistance and impact properties compared to rutile products
- High deposition in the flat and horizontal positions
- H4 diffusible hydrogen levels
- Designed for welding with 100% CO<sub>2</sub> shielding gas
- Premium arc performance and bead appearance
- ProTech® foil bag packaging

## WELDING POSITIONS

Flat & Horizontal

## SHIELDING GAS

100% CO<sub>2</sub>  
Flow Rate: 40-55 CFH

## CONFORMANCES

**AWS A5:** E70T5-C1A4-CS1-H4, E70T-5C-JH4  
**CWB/CSA:** E490T5-C1A4-CS1-H4, E492T-5J-H4  
**ISO:** T49 4 T5-0 C1 A H5

## TYPICAL APPLICATIONS

- Highly restrained joints
- Heaving equipment
- Mining
- Hard to weld base metals
- Thick steel sections in structural fabrication

## DIAMETERS / PACKAGING

Diameter in (mm)	50 lb (22.7 kg) Coil
1/16 (1.6)	ED032974
5/64 (2.0)	ED032975
3/32 (2.4)	ED032940

## MECHANICAL PROPERTIES<sup>(1)</sup>

	Yield Strength <sup>(2)</sup> MPa (ksi)	Tensile Strength MPa (ksi)	Elongation %	Charpy V-Notch J (ft•lbf)	
				@ -29°C (-20°F)	@ -40°C (-40°F)
<b>Requirements<sup>(4)</sup></b> - AWS E70T-5C-JH4	400 (58) min	480-655 (70-95)	22 min	27 (20) min	27 (20) min
<b>Typical Results<sup>(3)</sup></b> As-Welded with 100% CO <sub>2</sub>	465-510 (68-74)	545-580 (79-84)	29-32	91-142 (67-105)	53-113 (39-83)

**DEPOSIT COMPOSITION<sup>(1)</sup>**

	%C	%Mn	%Si	%S	%P	Diffusible Hydrogen (mL/100g weld deposit)
<b>Requirements<sup>(4)</sup></b> - AWS E70T-5C-JH4	0.12 max	1.75 max	0.90 max	0.03 max	0.03 max	4.0 max
<b>Typical Results<sup>(3)</sup></b> As-Welded with 100% CO <sub>2</sub>	0.06-0.08	1.51-1.66	0.44-0.53	0.01	0.01	2-4

**TYPICAL OPERATING PROCEDURES – Flat & Horizontal**

Diameter, Polarity Shielding Gas	CTWD <sup>(5)</sup> mm (in)	Wire Feed Speed m/min (in/min)	Voltage (volts)	Approx. Current (amps)	Melt-Off Rate kg/hr (lb/hr)	Deposition Rate kg/hr (lb/hr)	Efficiency (%)
1/16 in (1.6 mm), DC+ 100% CO <sub>2</sub>	19-25 (3/4-1)	5.1 (200)	29-34	230	4.0 (8.7)	3.1 (6.9)	76-86
		6.4 (250)	31-36	270	5.0 (11.0)	3.8 (8.5)	
		7.6 (300)	32-37	295	5.9 (13.1)	4.5 (10.0)	
		8.9 (350)	33-38	335	6.9 (15.2)	5.5 (12.1)	
		10.2 (400)	33-38	360	7.9 (17.4)	6.3 (13.9)	
		12.7 (500)	35-40	415	9.9 (21.8)	7.9 (17.5)	
5/64 in (2.0 mm), DC+ 100% CO <sub>2</sub>	25-32 (1-1 1/4)	5.1 (200)	29-34	295	5.7 (12.7)	4.8 (10.5)	82-86
		6.4 (250)	30-35	345	7.2 (15.9)	6.0 (13.2)	
		7.6 (300)	32-37	390	8.6 (19.0)	7.1 (15.6)	
		8.9 (350)	33-38	425	10.1 (22.3)	8.5 (18.7)	
		10.2 (400)	34-39	465	11.5 (25.3)	9.9 (21.8)	
3/32 in (2.4 mm), DC+ 100% CO <sub>2</sub>	32 (1-3/8)	3.2 (125)	23-28	335	5.5 (12.2)	4.8 (10.7)	87-90
		5.1 (200)	27-32	445	8.8 (19.3)	7.6 (16.7)	
		6.4 (250)	29-34	500	10.9 (24.1)	9.6 (21.3)	
		7.6 (300)	31-36	590	13.2 (29.2)	11.8 (26.0)	
		8.3 (325)	32-37	605	14.2 (31.4)	12.8 (28.3)	

<sup>(1)</sup>Typical all weld metal. <sup>(2)</sup>Measured with 0.2% offset. <sup>(3)</sup>See test results disclaimer <sup>(4)</sup>As-Welded with 100% CO<sub>2</sub>. <sup>(5)</sup>To estimate ESO, subtract 1/4 in (6.0 mm) from CTWD.



# ULTRACORE® XP70

Mild Steel, Flat & Horizontal ▪ AWS E70T-9C-H8, E70T1-C1A2-CS1-H8

## KEY FEATURES

- High deposition in the flat and horizontal positions
- Low spatter generation
- Good weld bead wetting
- Excellent slag detachability, even in deep or narrow grooves
- Wide operating range for great operator appeal across all skill levels

## WELDING POSITIONS

Flat & Horizontal

## CONFORMANCES

- AWS A5:** E70T1-C1A2-CS1-H8, E70T-1C-H8, E70T-9C-H8
- ABS:** 3YSA H5
- AWS D1.8:** 3/32"

## TYPICAL APPLICATIONS

- Structural fabrication
- Heavy equipment

## SHIELDING GAS

100% CO<sub>2</sub>  
Flow Rate: 40-55 CFH

## DIAMETERS / PACKAGING

Diameter in (mm)	50 lb (22.7 kg) Coil	500 lb (227 kg) Accu-Trak® Drum	500 lb (227 kg) Speed-Feed® Drum
1/16 (1.6)	ED036431	ED036547	
5/64 (2.0)	ED036430		ED036642
3/32 (2.4)	ED036427		ED036515

## MECHANICAL PROPERTIES<sup>(1)</sup>

	Yield Strength <sup>(2)</sup> MPa (ksi)	Tensile Strength MPa (ksi)	Elongation %	Charpy V-Notch J (ft·lbf)	
				@ -18°C (0°F)	@ -29°C (-20°F)
<b>Requirements<sup>(4)</sup></b> AWS A5.20: E70T-1C-H8, E70T-9C-H8 AWS A5.36: E70T-1-C1A2-CS1-H8	400 (58) min	480-655 (70-95)	22 min	27 (20) min	27 (20) min
<b>Typical Results<sup>(3)</sup></b> As-Welded with 100% CO <sub>2</sub>	495-555 (72-81)	570-625 (82-91)	25-29	35-59 (26-44)	27-59 (20-44)

**DEPOSIT COMPOSITION<sup>(1)</sup>**

	%C	%Mn	%Si	%S	%P	%B	Diffusible Hydrogen (mL/100g weld deposit)
<b>Requirements<sup>(4)</sup></b>							
AWS A5.20 E70T-1C-H8, E70T-9C-H8	0.12 max	1.75 max	0.90 max	0.03 max	0.03 max	Not Specified	8.0 max
AWS A5.36 E70T-1-C1A2-CS1-H8				0.030 max	0.030 max		8 max
<b>Typical Results<sup>(3)</sup></b>							
As-Welded with 100% CO <sub>2</sub>	0.03 - 0.06	1.44 - 1.64	0.49 - 0.56	≤ 0.008	<0.016	<0.0042	2-4

**TYPICAL OPERATING PROCEDURES – Flat & Horizontal**

Diameter, Polarity Shielding Gas	CTWD <sup>(2)</sup> mm (in)	Wire Feed Speed m/min (in/min)	Voltage (volts)	Approx. Current (amps)	Melt-Off Rate kg/hr (lb/hr)	Deposition Rate kg/hr (lb/hr)	Efficiency (%)
1/16 in (1.6 mm), DC+ 100% CO <sub>2</sub>	19 (3/4)	3.2 (125)	26-30	165	2.4 (5.2)	2.1 (4.6)	87 - 90
		5.1 (200)	27-31	255	3.8 (8.3)	3.4 (7.4)	
6.4 (250)		27-31	300	4.8 (10.4)	4.2 (9.3)		
5/64 in (2.0 mm), DC+ 100% CO <sub>2</sub>	25 (1)	7.6 (300)	28-32	300	5.7 (12.5)	5.1 (11.2)	
		9.5 (375)	28-32	315	7.1 (15.6)	6.4 (14.1)	
	25 (1)	3.2 (125)	27-31	260	3.8 (8.3)	3.3 (7.2)	
		4.4 (175)	27-31	330	5.3 (11.7)	4.7 (10.4)	
		5.7 (225)	27-31	390	6.8 (15.0)	6.1 (13.5)	
6.4 (250)		28-32	420	7.6 (16.7)	6.8 (15.1)		
3/32 in (2.4 mm), DC+ 100% CO <sub>2</sub>	25 (1)	7.0 (275)	28-32	450	8.3 (18.4)	7.6 (16.7)	
		7.6 (300)	28-32	475	9.1 (20.0)	8.3 (18.2)	
	8.3 (325)	29-33	500	9.8 (21.7)	9.0 (19.8)		
3/32 in (2.4 mm), DC+ 100% CO <sub>2</sub>	25 (1)	3.2 (125)	28-32	360	5.4 (12.0)	4.9 (10.9)	88 - 91
		5.1 (200)	28-32	490	8.7 (19.2)	7.8 (17.1)	
		6.4 (250)	29-33	575	10.9 (24.0)	9.7 (21.3)	
	32 (1 1/4)	7.0 (275)	29-33	450	12.0 (26.5)	10.6 (23.4)	
		7.6 (300)	30-34	575	13.1 (28.9)	11.5 (25.4)	
		8.3 (325)	31-35	615	14.2 (31.3)	12.5 (27.5)	

<sup>(1)</sup> Typical all weld metal. <sup>(2)</sup> Measured with 0.2% offset. <sup>(3)</sup> See test results disclaimer. <sup>(4)</sup> As-Welded with 100% CO<sub>2</sub>. <sup>(5)</sup> To estimate ESO, subtract 1/4 in (6.0 mm) from CTWD.

# OUTERSHIELD® 70

Mild Steel, Flat & Horizontal ▪ AWS E70T-9C, E70T1-C1A2-CS1-H16

## KEY FEATURES

- High deposition in the flat and horizontal positions
- Designed for welding with 100% CO<sub>2</sub> shielding gas
- Excellent bead wetting and low spatter
- Tolerates mild levels of surface contaminants
- Stiff wire for easy breaking
- ProTech® foil bag packaging

## WELDING POSITIONS

Flat & Horizontal

## SHIELDING GAS

100% CO<sub>2</sub>  
Flow Rate: 40-55 CFH

## CONFORMANCES

<b>AWS A5.20:</b>	E70T-1C-H16, E70T-9C-H16
<b>AWS A5.36:</b>	E70T1-C1A2-CS1-H16
<b>ASME SFA-A5.20:</b>	E70T-1C-H16, E70T-9C-H16
<b>ABS:</b>	2YSA
<b>DNV Grade:</b>	II YMS H15
<b>CWB/CSA W48-06:</b>	E492T-9 H16
<b>TUV:</b>	EN 758 T 46 0 R C3 / M3 H10
<b>MIL-E-24403/1:</b>	MIL-70T-1C
<b>ISO 17632-B</b>	T 49 3 T1-0 C A -H10

## TYPICAL APPLICATIONS

- Structural fabrication
- Barge fabrication
- Heavy fabrication
- Construction equipment

## DIAMETERS / PACKAGING

Diameter in (mm)	50 lb (22.7 kg) Coil	600 lb (272 kg) Speed-Feed® Reel	600 lb (272 kg) Speed-Feed® Drum
1/16 (1.6)	ED012782	ED014588	
5/64 (2.0)	ED012785		
3/32 (2.4)	ED012784	ED014120	ED030262

## MECHANICAL PROPERTIES<sup>(1)</sup>

	Yield Strength <sup>(2)</sup> MPa (ksi)	Tensile Strength MPa (ksi)	Elongation %	Charpy V-Notch J (ft·lbf)	
				@ -18°C (0°F)	@ -29°C (-20°F)
<b>Requirements</b> AWS E70T-1C AWS E70T-9C	400 (58) min	485-655 (70-95)	22 min	27 (20) min –	– 27 (20) min
<b>Typical Results<sup>(3)</sup></b> As-Welded with 100% CO <sub>2</sub>	525-575 (76-83)	620-635 (90-92)	27-28	39-42 (29-31)	31-34 (21-25)
Stress Relieved with 100% CO <sub>2</sub> for 1 hr @ 621°C (1150°F)	525 (76)	555 (80)	27-28	27 (20)	24 (18)

**DEPOSIT COMPOSITION<sup>(1)</sup>**

	%C	%Mn	%Si	%S	%P
<b>Requirements</b> - AWS E70T-1C, E70T-9C	0.12 max	1.75 max	0.90 max	0.03 max	0.03 max
<b>Typical Results<sup>(3)</sup></b> As-Welded with 100% CO <sub>2</sub>	0.08	1.41-1.43	0.64-0.73	0.01	0.01

**TYPICAL OPERATING PROCEDURES**

Diameter, Polarity Shielding Gas	CTWD <sup>(4)</sup> mm (in)	Wire Feed Speed m/min (in/min)	Voltage (volts)	Approx. Current (amps)	Melt-Off Rate kg/hr (lb/hr)	Deposition Rate kg/hr (lb/hr)	Efficiency (%)
1/16 in (1.6 mm), DC+ 100% CO <sub>2</sub>	25 (1)	3.2 (125)	23-25	170	2.4 (5.3)	2.1 (4.6)	87
		5.1 (200)	25-27	235	3.8 (8.5)	3.4 (7.6)	87
		6.4 (250)	25-28	275	4.8 (10.6)	4.2 (9.2)	87
		7.6 (300)	27-29	310	5.8 (2.7)	5.0 (11.1)	87
		9.5 (375)	29-31	365	7.2 (15.9)	6.4 (14.0)	88
5/64 in (2.0 mm), DC+ 100% CO <sub>2</sub>	28 (1-1/8)	3.2 (125)	23-26	250	3.8 (8.4)	3.2 (7.0)	83
		4.4 (175)	26-28	350	5.4 (11.8)	4.5 (10.0)	85
		5.7 (225)	27-29	375	6.9 (15.2)	5.9 (13.0)	86
		6.4 (250)	29-31	400	7.7 (16.9)	6.5 (14.4)	86
		7.6 (300)	30-32	450	9.2 (20.2)	7.9 (17.4)	86
		8.3 (325)	31-33	470	9.9 (21.9)	8.5 (18.8)	86
3/32 in (2.4 mm), DC+ 100% CO <sub>2</sub>	32 (1-1/4)	3.2 (125)	24-27	335	5.3 (11.7)	4.4 (9.8)	84
		5.1 (200)	28-31	455	8.5 (18.6)	7.3 (16.0)	86
		6.4 (250)	30-32	530	10.6 (23.3)	9.2 (20.2)	87
		7.6 (300)	31-34	590	12.7 (28.0)	11.0 (24.3)	87
		8.3 (325)	33-35	615	13.7 (30.3)	12.0 (26.4)	87

<sup>(1)</sup>Typical all weld metal. <sup>(2)</sup>Measured with 0.2% offset. <sup>(3)</sup>See test results disclaimer <sup>(4)</sup>To estimate ESO, subtract 1/4 in (6.0 mm) from CTWD.  
NOTE: This product contains micro-alloying elements. Additional information available upon request.

# OUTERSHIELD® XLH-70

Mild Steel, Flat & Horizontal ▪ AWS E70T-9C-H8, E70T1-C1A2-CS1-H8

## KEY FEATURES

- Meets AWS D1.8 seismic lot waiver requirements for demand critical welds
- H8 diffusible hydrogen levels - controlled for high resistance to hydrogen induced cracking.
- High deposition rates and excellent fast follow characteristics
- Stiff wire enables feeding over long distances
- Tolerates mild levels of surface contaminants
- Designed for welding with CO<sub>2</sub> shielding gas
- ProTech® foil bag packaging

## WELDING POSITIONS

Flat & Horizontal

## CONFORMANCES

- AWS A5:** E70T1-C1A2-CS1-H8,  
E70T-1C-H8, E70T-9C-H8
- ABS:** 3YSA H5
- AWS D1.8:** 3/32"

## TYPICAL APPLICATIONS

- Structural fabrication
- General fabrication
- Machinery fabrication
- Heavy equipment
- Seismic applications

## SHIELDING GAS

100% CO<sub>2</sub>  
Flow Rate: 40-55 CFH

## DIAMETERS / PACKAGING

Diameter in (mm)	50 lb (22.7 kg) Coil	500 lb (227 kg) Speed-Feed® Drum
3/32 (2.4)	ED030236	ED030360

NOTE: Speed-Feed® drums require rotation for proper payoff.

## MECHANICAL PROPERTIES<sup>(1)</sup>

	Yield Strength <sup>(2)</sup> MPa (ksi)	Tensile Strength MPa (ksi)	Elongation %	Charpy V-Notch J (ft·lbf)	
				@ -18°C (0°F)	@ -29°C (-20°F)
<b>Requirements</b> AWS E70T-1C-H8 AWS E70T-9C-H8	400 (58) min	480-660 (70-95)	22 min	27 (20) min –	– 27 (20) min
<b>Typical Results<sup>(3)</sup></b> As-Welded with 100% CO <sub>2</sub>	480-530 (70-77)	570-620 (82-89)	27-30	61-134 (45-99)	42-107 (31-79)

**DEPOSIT COMPOSITION<sup>(1)</sup>**

	<b>%C</b>	<b>%Mn</b>	<b>%Si</b>
<b>Requirements</b> - AWS E70T-1C-H8, E70T-9C-H8	0.12 max	1.75 max	0.90 max
<b>Test Results<sup>(3)</sup></b> As-Welded with 100% CO <sub>2</sub>	0.06-0.07	1.40-1.60	0.48-0.58
	<b>%S</b>	<b>%P</b>	<b>Diffusible Hydrogen (mL/100g weld deposit)</b>
<b>Requirements</b> - AWS E70T-1C-H8, E70T-9C-H8	0.03 max	0.03 max	8.0 max
<b>Test Results<sup>(3)</sup></b> As-Welded with 100% CO <sub>2</sub>	≤0.01	≤0.01	3-6

**TYPICAL OPERATING PROCEDURES**

<b>Diameter, Polarity Shielding Gas</b>	<b>CTWD<sup>(4)</sup> mm (in)</b>	<b>Wire Feed Speed m/min (in/min)</b>	<b>Voltage (volts)</b>	<b>Approx. Current (amps)</b>	<b>Melt-Off Rate kg/hr (lb/hr)</b>	<b>Deposition Rate kg/hr (lb/hr)</b>	<b>Efficiency (%)</b>
3/32 in. (2.4 mm), DC+ 100% CO <sub>2</sub>	32 (1-1/4)	3.8 (150)	23-26	345	6.5 (14.4)	5.6 (12.4)	86
		5.1 (200)	27-30	445	8.7 (19.2)	7.6 (16.8)	87
		6.4 (250)	28-31	510	10.9 (24.0)	9.5 (21.0)	87
		7.6 (300)	30-32	570	13.1 (28.8)	11.4 (25.2)	87
		8.3 (325)	31-33	600	14.2 (31.2)	12.4 (27.3)	87

<sup>(1)</sup>Typical all weld metal. <sup>(2)</sup>Measured with 0.2% offset. <sup>(3)</sup>See test results disclaimer <sup>(4)</sup>To estimate ESO, subtract 1/4 in (6.0 mm) from CTWD.

# ULTRACORE® 81Ni1A75-H

Low Alloy, All Position ▪ AWS E81T1-Ni1M-JH4, E81T1-M21A4-Ni1-H4



## KEY FEATURES

- Capable of producing weld deposits with impact toughness exceeding 88 - 123 J (65 - 91 ft·lbf) at -40°C (-40°F)
- Designed for welding with 75-85% Argon/ balance CO<sub>2</sub> shielding gas
- Premium arc performance and bead appearance
- Meets AWS D1.8 seismic lot waiver requirements
- ProTech® foil bag packaging
- Color match on weathering steel

## CONFORMANCES

- AWS A5:** E81T1-M21A4-Ni1-H4 E81T1-Ni1M-JH4
- ABS:** 4YQ460SA H5
- CWB/CSA:** E551T1-M21A4-Ni1M-H4 E551T1-Ni1M-JH4
- DNV:** IV Y46MS H5
- Lloyd's Register:** 4Y46S H5
- AWS D1.8:** 0.045", 0.052", 1/16"
- ISO:** T55 4 T1-1 M21 A-N2 H5

## WELDING POSITIONS

All

## SHIELDING GAS

75% - 85% Argon / Balance CO<sub>2</sub>  
Flow Rate: 40-50 CFH

## TYPICAL APPLICATIONS

- Bridge fabrication
- Weathering steels
- Offshore
- Structural fabrication
- NACE applications

## DIAMETERS / PACKAGING

Diameter in (mm)	33 lb (15 kg) Spool**	500 lb (227 kg) Accu-Trak® Drum
0.045 (1.1)	ED032206, ED034411*	
0.052 (1.3)	ED032279	ED034412*
1/16 (1.6)	ED032207, ED034413*	

\*Buy America Product \*\*Spool may be plastic or fiber.

## MECHANICAL PROPERTIES<sup>(1)</sup>

	Yield Strength <sup>(2)</sup> MPa (ksi)	Tensile Strength MPa (ksi)	Elongation %	Charpy V-Notch J (ft·lbf)	
				@ -29°C (-20°F)	@ -40°C (-40°F)
<b>Requirements<sup>(4)</sup></b> - AWS E81T1-Ni1M-JH4	470 (68) min	550-690 (80-100)	19 min	27 (20) min	27 (20) min
<b>Typical Results<sup>(3)</sup></b> As-Welded with 75% Ar/25% CO <sub>2</sub>	545-595 (79-86)	595-640 (86-93)	24-28	107-142 (79-105)	88-123 (65-91)

**DEPOSIT COMPOSITION<sup>(1)</sup>**

	%C	%Mn	%Si	%S	%P	%Ni
<b>Requirements<sup>(4)</sup></b> - AWS E81T1-Ni1M-JH4	0.12 max	1.50 max	0.80 max	0.030 max	0.030 max	0.80-1.10
<b>Typical Results<sup>(3)</sup></b> As-Welded with 75% Ar/25% CO <sub>2</sub>	0.04-0.05	1.26-1.36	0.25-0.29	0.006-0.009	0.005-0.008	0.86-0.96
	%Mo	%Cr	%V	%B	Diffusible Hydrogen (mL/100g weld deposit)	
<b>Requirements<sup>(4)</sup></b> - AWS E81T1-Ni1M-JH4	0.35 max	0.15 max	0.05 max	Not Specified	4.0 max	
<b>Typical Results<sup>(3)</sup></b> As-Welded with 75% Ar/25% CO <sub>2</sub>	0.01	0.04-0.05	0.02-0.03	0.005-0.007	2-4	

**TYPICAL OPERATING PROCEDURES**

Diameter, Polarity Shielding Gas	CTWD <sup>(5)</sup> mm (in)	Wire Feed Speed m/min (in/min)	Voltage (volts)	Approx. Current (amps)	Melt-Off Rate kg/hr (lb/hr)	Deposition Rate kg/hr (lb/hr)	Efficiency (%)
0.045 in (1.1 mm), DC+ 75%-85% Ar/ balance CO <sub>2</sub>	25 (1)	4.4 (175)	22-27	140	1.8 (4.0)	1.6 (3.5)	86-88
		5.1 (200)	23-28	150	2.1 (4.6)	1.8 (4.0)	
		6.4 (250)	24-29	165	2.6 (5.7)	2.3 (5.0)	
		7.6 (300)	24-29	190	3.1 (6.8)	2.7 (6.0)	
		8.9 (350)	25-30	205	3.6 (8.0)	3.2 (7.0)	
		9.5 (375)	25-30	225	3.9 (8.6)	3.4 (7.5)	
		10.8 (425)	26-31	245	4.4 (9.7)	3.8 (8.5)	
		12.1 (475)	27-32	265	4.9 (10.8)	4.3 (9.5)	
0.052 in (1.3 mm), DC+ 75%-85% Ar/ balance CO <sub>2</sub>	25 (1)	3.8 (150)	22-27	150	2.0 (4.5)	1.8 (3.9)	86-88
		4.7 (185)	23-28	165	2.5 (5.5)	2.2 (4.8)	
		5.7 (225)	23-28	190	3.1 (6.7)	2.7 (5.9)	
		6.4 (250)	24-29	215	3.4 (7.5)	2.9 (6.5)	
		7.0 (275)	24-29	235	3.7 (8.2)	3.2 (7.2)	
		7.6 (300)	25-30	265	4.1 (9.0)	3.5 (7.8)	
		8.5 (335)	25-31	275	4.5 (10.0)	4.0 (8.7)	
		9.5 (375)	26-32	295	5.1 (11.2)	4.4 (9.8)	
1/16 in (1.6 mm), DC+ 75%-85% Ar/ balance CO <sub>2</sub>	25 (1)	3.8 (150)	22-27	200	2.9 (6.3)	2.5 (5.5)	86-88
		4.4 (175)	23-28	210	3.3 (7.4)	2.9 (6.4)	
		5.1 (200)	24-29	235	3.8 (8.4)	3.3 (7.3)	
		5.7 (225)	24-29	265	4.3 (9.5)	3.7 (8.2)	
		6.5 (250)	25-30	285	4.8 (10.5)	4.2 (9.2)	
		7.0 (275)	25-31	315	5.3 (11.6)	4.6 (10.1)	
		8.3 (325)	26-32	335	6.2 (13.7)	5.4 (11.9)	
		8.9 (350)	27-33	365	6.7 (14.7)	5.8 (12.8)	

<sup>(1)</sup>Typical all weld metal. <sup>(2)</sup>Measured with 0.2% offset. <sup>(3)</sup>See test results disclaimer <sup>(4)</sup>As-Welded with 75% Argon / 25% CO<sub>2</sub>. <sup>(5)</sup>To estimate ESO, subtract 1/4 in (6.0 mm) from CTWD.  
NOTE 1: FEMA and AWS D1.8 structural steel seismic supplement test data can be found on this product at [www.lincolnelectric.com](http://www.lincolnelectric.com). NOTE 2: This product contains micro-alloying elements.  
Additional information available upon request.



# ULTRACORE® 81Ni1C-H

Low Alloy, All Position ▪ AWS E81T1-Ni1C-JH4, E81T1-C1A4-Ni1-H4



## KEY FEATURES

- Capable of producing weld deposits with impact toughness exceeding 84 - 130 J (62 - 96 ft•lbf) at -40°C (-40°F)
- Designed for welding with 100% CO<sub>2</sub> shielding gas
- Premium arc performance and bead appearance
- Meets AWS D1.8 seismic lot waiver requirements
- ProTech® foil bag packaging
- Color match on weathering steels

## CONFORMANCES

- AWS A5:** E81T1-C1A4-Ni1-H4, E81T1-Ni1C-JH4
- ABS:** 4YQ460SA H5
- CWB/CSA:** E551T1-C1A4-Ni1-H4 E551T1-Ni1C-JH4
- DNV:** IV Y46MS H5
- Lloyd's Register:** 4Y46S H5
- AWS D1.8:** 0.045", 0.052", 1/16"
- ISO:** T55 4 T1-1 C1 A-N2- H5

## WELDING POSITIONS

All

## SHIELDING GAS

100% CO<sub>2</sub>  
Flow Rate: 40-50 CFH

## TYPICAL APPLICATIONS

- Bridge fabrication
- Weathering steels
- Offshore
- Structural fabrication
- NACE applications

## DIAMETERS / PACKAGING

Diameter in (mm)	33 lb (15 kg) Spool**	50 lb (22.7 kg) Fiber Spool
0.045 (1.1)	ED032204, ED034414*	ED032745, ED034416*
0.052 (1.3)	ED032280, ED034415*	
1/16 (1.6)	ED032205	

\*Buy America Product \*\*Spool may be plastic or fiber.

## MECHANICAL PROPERTIES<sup>(1)</sup>

	Yield Strength <sup>(2)</sup> MPa (ksi)	Tensile Strength MPa (ksi)	Elongation %	Charpy V-Notch J (ft•lbf)	
				@ -29°C (-20°F)	@ -40°C (-40°F)
<b>Requirements<sup>(4)</sup></b> - AWS E81T1-Ni1C-JH4	470 (68) min	550-690 (80-100)	19 min	27 (20) min	27 (20) min
<b>Typical Results<sup>(3)</sup></b> As-Welded with 100% CO <sub>2</sub>	540-585 (78-84)	595-635 (86-91)	25-28	111-152 (82-112)	84-130 (62-96)

**DEPOSIT COMPOSITION<sup>(1)</sup>**

	%C	%Mn	%Si	%S	%P	%Ni
<b>Requirements<sup>(4)</sup></b> - AWS E81T1-Ni1C-JH4	0.12 max	1.50 max	0.80 max	0.030 max	0.030 max	0.80-1.10
<b>Typical Results<sup>(3)</sup></b> As-Welded with 100% CO <sub>2</sub>	0.04-0.05	1.24-1.34	0.27-0.31	0.006-0.007	0.007-0.009	0.88-0.99
	%Mo	%Cr	%V	%B	Diffusible Hydrogen (mL/100g weld deposit)	
<b>Requirements<sup>(4)</sup></b> - AWS E81T1-Ni1C-JH4	0.35 max	0.15 max	0.05 max	Not Specified	4.0max	
<b>Typical Results<sup>(3)</sup></b> As-Welded with 100% CO <sub>2</sub>	0.01	0.04-0.05	0.02-0.03	0.005-0.006	3-4	

**TYPICAL OPERATING PROCEDURES**

Diameter, Polarity Shielding Gas	CTWD <sup>(5)</sup> mm (in)	Wire Feed Speed m/min (in/min)	Voltage (volts)	Approx. Current (amps)	Melt-Off Rate kg/hr (lb/hr)	Deposition Rate kg/hr (lb/hr)	Efficiency (%)
0.045 in (1.1 mm), DC+ 100% CO <sub>2</sub>	25 (1)	4.4 (175)	23-28	140	1.8 (4.0)	1.6 (3.5)	86-88
		5.1 (200)	24-29	150	2.1 (4.6)	1.8 (4.0)	
		6.4 (250)	25-30	165	2.6 (5.7)	2.3 (5.0)	
		7.6 (300)	25-30	190	3.1 (6.8)	2.7 (6.0)	
		8.9 (350)	26-31	205	3.6 (8.0)	3.2 (7.0)	
		9.5 (375)	26-31	225	3.9 (8.6)	3.4 (7.5)	
		10.8 (425)	27-32	245	4.4 (9.7)	3.8 (8.5)	
		12.1 (475)	28-33	265	4.9 (10.8)	4.3 (9.5)	
		12.7 (500)	29-34	275	5.2 (11.4)	4.5 (10.0)	
0.052 in (1.3 mm), DC+ 100% CO <sub>2</sub>	25 (1)	3.8 (150)	23-28	150	2.0 (4.5)	1.8 (3.9)	86-88
		4.7 (185)	24-29	165	2.5 (5.5)	2.2 (4.8)	
		5.7 (225)	24-29	190	3.1 (6.7)	2.7 (5.9)	
		6.4 (250)	25-30	215	3.4 (7.5)	2.9 (6.5)	
		7.0 (275)	25-30	235	3.7 (8.2)	3.2 (7.2)	
		7.6 (300)	26-31	255	4.1 (9.0)	3.5 (7.8)	
		8.5 (335)	26-31	275	4.5 (10.0)	4.0 (8.7)	
		9.5 (375)	27-32	295	5.1 (11.2)	4.4 (9.8)	
		10.2 (400)	27-34	310	5.4 (12.0)	4.7 (10.4)	
1/16 in (1.6 mm), DC+ 100% CO <sub>2</sub>	25 (1)	3.8 (150)	24-29	200	2.9 (6.3)	2.5 (5.5)	86-88
		4.4 (175)	24-30	210	3.3 (7.4)	2.9 (6.4)	
		5.1 (200)	25-30	235	3.8 (8.4)	3.3 (7.3)	
		5.7 (225)	25-31	265	4.3 (9.5)	3.7 (8.2)	
		6.4 (250)	26-31	285	4.8 (10.5)	4.2 (9.2)	
		7.0 (275)	26-32	305	5.3 (11.6)	4.6 (10.1)	
		8.3 (325)	27-32	335	6.2 (13.7)	5.4 (11.9)	
		8.9 (350)	28-34	365	6.7 (14.7)	5.8 (12.8)	

<sup>(1)</sup>Typical all weld metal. <sup>(2)</sup>Measured with 0.2% offset. <sup>(3)</sup>See test results disclaimer <sup>(4)</sup>As-Welded with 100% CO<sub>2</sub>. <sup>(5)</sup>To estimate ESO, subtract 1/4 in (6.0 mm) from CTWD.  
 NOTE 1: FEMA and AWS D1.8 structural steel seismic supplement test data can be found on this product at [www.lincolnelectric.com](http://www.lincolnelectric.com). NOTE 2: This product contains micro-alloying elements.  
 Additional information available upon request.

# ULTRACORE® 81Ni1C-H PLUS

Low Alloy, All Positions ▪ AWS E81T1-Ni1C-JH4, E81T1-C1A6-Ni1-H4

## KEY FEATURES

- Innovative design capable of superior toughness at -60°F in both the as-welded and stress-relieved conditions
- Designed for welding with 100% CO<sub>2</sub> shielding gas
- H4 diffusible hydrogen levels
- Q2 Lot® - Certificate showing actual deposit chemistry and mechanical properties per lot available online
- ProTech® foil bag packaging
- Designed to accommodate applications requiring Nickel content of 1% max

## WELDING POSITIONS

All

## SHIELDING GAS

100% CO<sub>2</sub>  
Flow Rate: 40-50 CFH

## CONFORMANCES

- AWS A5:** E81T1-C1A6-Ni1-H4, E81T1-C1P4-Ni1-H4, E81T1-Ni1C-JH4
- ABS:** 4YQ460SA H5
- CWB/CSA:** E551T1-C1A5-Ni1-H4, E551T1-Ni1C-JH4
- DNV:** IV Y46MS H5
- Lloyd's Register:** 4Y46S H5
- AWS D1.8:** 0.045", 0.052", 1/16"

## TYPICAL APPLICATIONS

- Offshore drilling rigs
- Low temperature storage tanks
- Ship building
- Construction
- Mining Equipment

## DIAMETERS / PACKAGING

Diameter in (mm)	33 lb (15kg) Plastic Spool
0.045 (1.1)	ED034858
0.052 (1.3)	ED034859
1/16 (1.6)	ED034860

## MECHANICAL PROPERTIES<sup>(1)</sup>

	Yield Strength <sup>(2)</sup> MPa (ksi)	Tensile Strength MPa (ksi)	Elongation (%)	Charpy V-Notch J (ft·lbf)	
				-40°C (-40°F)	-51°C (-60°F)
<b>Requirements</b>					
AWS A5.29: E81T1-Ni1C-JH4 As-Welded with 100% CO <sub>2</sub>	470 (68) min	550-690 (80-100)	19 min	27 (20) min	-
AWS A5.36: E81T1-C1A6-Ni1-H4 As-Welded with 100% CO <sub>2</sub>	470 (68) min	550-690 (80-100)	19 min	-	27 (20) min
AWS A5.36: E81T1-C1P4-Ni1-H4 Stress Relieved with 100% CO <sub>2</sub> for 1 hr @ 621°C (1150°F)	470 (68) min	550-690 (80-100)	19 min	27 (20) min	-
<b>Typical Results<sup>(3)</sup></b>					
As-Welded with 100% CO <sub>2</sub>	505-565 (73-82)	585-640 (85-93)	23-29	87-127 (54-94)	41-123 (30-91)
Stress Relieved with 100% CO <sub>2</sub> for 1 hr @ 621°C (1150°F)	475-530 (69-77)	560-620 (81-90)	26-30	41-108 (30-80)	-

<sup>(1)</sup> Typical all weld metal. <sup>(2)</sup> Measure with 0.2% offset. <sup>(3)</sup> See test results disclaimer

**DEPOSIT COMPOSITION<sup>(1)</sup>**

	%C	%Mn	%Si	%S	%P	%Ni
<b>Requirements</b> AWS A5.29: E81T1-Ni1C-JH4 AWS A5.36: E81T1-C1A6-Ni1-H4, E81T1-C1P4-Ni1-H4	0.12 max	1.50 max 1.75 max	0.80 max	0.030 max	0.030 max	0.80-1.10
<b>Typical Results<sup>(3)</sup></b> with 100% CO <sub>2</sub>	0.04-0.05	1.29-1.37	0.42-0.45	0.007-0.008	0.011	0.89-0.95
	%Cr	%Mo	%V	%B	Diffusible Hydrogen (mL/100g weld deposit)	
<b>Requirements</b> AWS A5.29: E81T1-Ni1C-JH4 AWS A5.36: E81T1-C1A6-Ni1-H4, E81T1-C1P4-Ni1-H4	0.15 max	0.35 max	0.05 max	Not Specified	4.0 max 4 max	
<b>Typical Results<sup>(3)</sup></b> with 100% CO <sub>2</sub>	0.05	0.10	0.00	0.004-0.005	2-4	

**TYPICAL OPERATING PROCEDURES**

Diameter, Polarity Shielding Gas	CTWD <sup>(4)</sup> mm (in)	Wire Feed Speed m/min (in/min)	Voltage (volts)	Approx. Current (amps)	Melt-Off Rate kg/hr (lb/hr)	Deposition Rate kg/hr (lb/hr)	Efficiency (%)
0.045 in (1.1 mm), DC+	19 (3/4)	4.4 (175)	25 - 29	120	1.8 (3.9)	1.5 (3.4)	85-87
	19 (3/4)	6.4 (250)	26 - 30	140	2.5 (5.6)	2.2 (4.8)	
	19 (3/4)	7.6 (300)	27 - 31	155	3.1 (6.8)	2.6 (5.8)	
	19 (3/4)	8.9 (350)	28 - 32	170	3.6 (7.9)	3.1 (6.8)	
	25 (1)	10.2 (400)	29 - 33	185	4.1 (9.0)	3.5 (7.8)	
	25 (1)	11.4 (450)	29 - 33	200	4.6 (10.1)	4.0 (8.8)	
0.052 in (1.3 mm), DC+	19 (3/4)	3.8 (150)	25 - 29	150	2.1 (4.7)	1.7 (3.8)	81-84
	19 (3/4)	5.1 (200)	26 - 30	170	2.9 (6.3)	2.4 (5.2)	
	19 (3/4)	6.4 (250)	27 - 31	195	3.5 (7.8)	3.0 (6.5)	
	25 (1)	7.6 (300)	28 - 32	215	4.3 (9.4)	3.6 (7.9)	
	25 (1)	8.9(350)	29 - 33	240	5.0 (11.0)	4.2 (9.2)	
1/16 in (1.6 mm), DC+	19 (3/4)	3.8 (150)	26 - 30	190	2.9 (6.4)	2.4 (5.3)	83-87
	19 (3/4)	4.4 (175)	26 - 30	205	3.4 (7.5)	2.9 (6.3)	
	19 (3/4)	5.1 (200)	27 - 31	220	3.9 (8.5)	3.3 (7.2)	
	19 (3/4)	5.7 (225)	27 - 31	230	4.4 (9.6)	3.7 (8.1)	
	19 (3/4)	6.4 (250)	28 - 32	245	4.8 (10.6)	4.1 (9.1)	
	25 (1)	7.6 (300)	28 - 32	275	5.8 (12.7)	4.9 (10.9)	
	25 (1)	8.3 (325)	29 - 33	290	6.3 (13.8)	5.4 (11.9)	
	25 (1)	8.9 (350)	29 - 33	300	6.7 (14.8)	5.8 (12.8)	

<sup>(1)</sup> Typical all weld metal. <sup>(2)</sup> Measure with 0.2% offset. <sup>(3)</sup> See test results disclaimer <sup>(4)</sup> To estimate ESO, subtract 1/4 in (6.0 mm) from CTWD.

# ULTRACORE® 81Ni1M-H PLUS

Low Alloy, All Positions ▪ AWS E81T1-Ni1M-JH4, E81T1-M21A6-Ni1-H4

## KEY FEATURES

- Innovative design capable of superior toughness at -60°F in both the as-welded and stress-relieved conditions
- Designed for welding with 75-80% Argon/ Balance CO<sub>2</sub> shielding gas
- H4 diffusible hydrogen levels
- Q2 Lot® - Certificate showing actual deposit chemistry and mechanical properties per lot available online
- ProTech® foil bag packaging
- Designed to accommodate applications requiring Nickel content of 1% max

## WELDING POSITIONS

All

## SHIELDING GAS

75-80% Argon / Balance CO<sub>2</sub>  
Flow Rate: 40-50 CFH

## CONFORMANCES

- AWS A5:** E81T1-M21A6-Ni1-H4, E81T1-M21P4-Ni1-H4, E81T1-Ni1M-JH4
- ABS:** 4YQ460SA H5
- CWB/CSA:** E551T1-M21A5-Ni1-H4, E551T1-Ni1M-JH4
- DNV:** IV Y46MS H5
- Lloyd's Register:** 4Y46S H5
- AWS D1.8:** 0.045", 0.052", 1/16"

## TYPICAL APPLICATIONS

- Offshore drilling rigs
- Low temperature storage tanks
- Ship building
- Construction
- Mining Equipment

## DIAMETERS / PACKAGING

Diameter in (mm)	33 lb (15kg) Plastic Spool
0.045 (1.1)	ED034855
0.052 (1.3)	ED034856
1/16 (1.6)	ED034857

## MECHANICAL PROPERTIES<sup>(1)</sup>

	Yield Strength <sup>(2)</sup> MPa (ksi)	Tensile Strength MPa (ksi)	Elongation (%)	Charpy V-Notch J (ft·lbf)	
				-40°C (-40°F)	-51°C (-60°F)
<b>Requirements</b>					
AWS A5.29: E81T1-Ni1M-JH4 As-Welded with 75% Ar / 25% CO <sub>2</sub>	470 (68) min	550-690 (80-100)	19 min	27 (20) min	-
AWS A5.36: E81T1-M21A6-Ni1-H4 As-Welded with 75% Ar / 25% CO <sub>2</sub>	470 (68) min	550-690 (80-100)	19 min	-	27 (20) min
AWS A5.36: E81T1-M21P4-Ni1-H4 Stress Relieved with 75% Ar / 25% CO <sub>2</sub> for 1 hr @ 621°C (1150°F)	470 (68) min	550-690 (80-100)	19 min	27 (20) min	-
<b>Typical Results<sup>(3)</sup></b>					
As-Welded with 75% Ar / 25% CO <sub>2</sub>	505-530 (73-77)	582-605 (84-88)	26-28	92-104 (68-77)	80-89 (59-66)
Stress Relieved with 75% Ar / 25% CO <sub>2</sub> for 1 hr @ 621°C (1150°F)	475-493 (69-71)	575-588 (83-85)	27-29	80-96 (59-71)	-

<sup>(1)</sup> Typical all weld metal. <sup>(2)</sup> Measure with 0.2% offset. <sup>(3)</sup> See test results disclaimer

**DEPOSIT COMPOSITION<sup>(1)</sup>**

	%C	%Mn	%Si	%S	%P	%Ni
<b>Requirements</b> AWS A5.29: E81T1-Ni1M-JH4 AWS A5.36: E81T1-M21A6-Ni1-H4, E81T1-M21P4-Ni1-H4	0.12 max	1.50 max	0.80 max	0.030 max	0.030 max	0.80-1.10
		1.75 max				
<b>Typical Results<sup>(3)</sup></b> with 75% Argon / 25% CO <sub>2</sub>	0.05-0.06	1.31-1.38	0.41-0.44	0.007	0.012	0.83-0.87
	%Cr	%Mo	%V	%B	Diffusible Hydrogen (mL/100g weld deposit)	
<b>Requirements</b> AWS A5.29: E81T1-Ni1M-JH4 AWS A5.36: E81T1-M21A6-Ni1-H4, E81T1-M21P4-Ni1-H4	0.15 max	0.35 max	0.05 max	Not Specified	4.0 max	
					4 max	
<b>Typical Results<sup>(3)</sup></b> with 75% Argon / 25% CO <sub>2</sub>	0.05	0.01	0.00	0.005-0.006	2-4	

**TYPICAL OPERATING PROCEDURES**

Diameter, Polarity Shielding Gas	CTWD <sup>(4)</sup> mm (in)	Wire Feed Speed m/min (in/min)	Voltage (volts)	Approx. Current (amps)	Melt-Off Rate kg/hr (lb/hr)	Deposition Rate kg/hr (lb/hr)	Efficiency (%)
0.045 in (1.1 mm), DC+	19 (3/4)	4.4 (175)	24 - 28	120	1.8 (3.9)	1.5 (3.4)	85-87
	19 (3/4)	6.4 (250)	25 - 29	140	2.5 (5.6)	2.2 (4.8)	
	19 (3/4)	7.6 (300)	26 - 30	155	3.1 (6.8)	2.6 (5.8)	
	19 (3/4)	8.9 (350)	27 - 31	170	3.6 (7.9)	3.1 (6.8)	
	25 (1)	10.2 (400)	28 - 32	185	4.1 (9.0)	3.5 (7.8)	
	25 (1)	11.4 (450)	28 - 32	200	4.6 (10.1)	4.0 (8.8)	
	25 (1)	12.7 (500)	29 - 33	220	5.1 (11.3)	4.4 (9.8)	
0.052 in (1.3 mm), DC+	19 (3/4)	3.8 (150)	24 - 28	150	2.1 (4.7)	1.7 (3.8)	81-84
	19 (3/4)	5.1 (200)	25 - 29	170	2.9 (6.3)	2.4 (5.2)	
	19 (3/4)	6.4 (250)	26 - 30	195	3.5 (7.8)	3.0 (6.5)	
	25 (1)	7.6 (300)	27 - 31	215	4.3 (9.4)	3.6 (7.9)	
	25 (1)	8.9 (350)	28 - 32	240	5.0 (11.0)	4.2 (9.2)	
1/16 in (1.6 mm), DC+	19 (3/4)	3.8 (150)	25 - 29	190	2.9 (6.4)	2.4 (5.3)	83-87
	19 (3/4)	4.4 (175)	25 - 29	205	3.4 (7.5)	2.9 (6.3)	
	19 (3/4)	5.1 (200)	26 - 30	220	3.9 (8.5)	3.3 (7.2)	
	19 (3/4)	5.7 (225)	26 - 30	230	4.4 (9.6)	3.7 (8.1)	
	19 (3/4)	6.4 (250)	27 - 31	245	4.8 (10.6)	4.1 (9.1)	
	25 (1)	7.6 (300)	27 - 31	275	5.8 (12.7)	4.9 (10.9)	
	25 (1)	8.3 (325)	28 - 32	290	6.3 (13.8)	5.4 (11.9)	
	25 (1)	8.9 (350)	28 - 32	300	6.7 (14.8)	5.8 (12.8)	

<sup>(1)</sup> Typical all weld metal. <sup>(2)</sup> Measure with 0.2% offset. <sup>(3)</sup> See test results disclaimer <sup>(4)</sup> To estimate ESO, subtract 1/4 in (6.0 mm) from CTWD.

# ULTRACORE® 81Ni2A75-H

Low Alloy, All Position ▪ AWS E81T1-Ni2M-JH4, E81T1-M21A6-Ni2-H4

## KEY FEATURES

- Capable of producing weld deposits with impact toughness exceeding 41 - 89 J (30 - 66 ft•lbf) at -51°C (-60°F)
- Designed for welding with 75-85% Argon/ Balance CO<sub>2</sub> shielding gas
- Premium arc performance and bead appearance
- H4 diffusible hydrogen levels
- ProTech® foil bag packaging

## WELDING POSITIONS

All

## SHIELDING GAS

75% - 85% Argon / Balance CO<sub>2</sub>  
Flow Rate: 40-55 CFH

## CONFORMANCES

<b>AWS A5:</b>	E81T1-M21A6-Ni2-H4, E81T1-Ni2M-JH4
<b>ABS:</b>	3YSA H5
<b>CWB/CSA:</b>	E551T1-M21A5-Ni2-H4, E551T1-Ni2M-JH4
<b>DNV:</b>	III Y40MS H5
<b>Lloyd's Register:</b>	3YS H5
<b>ISO:</b>	T55 6 T1-1 M21 A-N5 H5

## TYPICAL APPLICATIONS

- Mining
- Offshore
- Bridge fabrication
- High strength fabrication

## DIAMETERS / PACKAGING

Diameter in (mm)	33 lb (15 kg) Spool*
0.045 (1.1)	ED032217
0.052 (1.3)	ED032277
1/16 (1.6)	ED032216

\*Spool may be plastic or fiber.

## MECHANICAL PROPERTIES<sup>(1)</sup>

	Yield Strength <sup>(2)</sup> MPa (ksi)	Tensile Strength MPa (ksi)	Elongation %	Charpy V-Notch J (ft•lbf)	
				@ -40°C (-40°F)	@ -51°C (-60°F)
<b>Requirements<sup>(4)</sup></b> - AWS E81T-1Ni2M-JH4	470 (68) min	550-670 (80-100)	19 min	27 (20) min	27 (20) min
<b>Typical Results<sup>(3)</sup></b> As-Welded with 75% Ar/25% CO <sub>2</sub>	555-580 (80-84)	615-635 (89-92)	25-28	69-115 (51-85)	41-89 (30-66)

**DEPOSIT COMPOSITION<sup>(1)</sup>**

	%C	%Mn	%Si	%S
<b>Requirements<sup>(4)</sup></b> - AWS E81T1-Ni2M-JH4	0.12 max	1.50 max	0.80 max	0.030 max
<b>Typical Results<sup>(3)</sup></b> As-Welded with 75% Ar/25% CO <sub>2</sub>	0.04-0.05	0.93-1.05	0.25-0.28	0.005-0.006
	%P	%Ni	%B	Diffusible Hydrogen (mL/100g weld deposit)
<b>Requirements<sup>(4)</sup></b> - AWS E81T1-Ni2M-JH4	0.030 max	1.75-2.75	Not Specified	4.0 max
<b>Typical Results<sup>(3)</sup></b> As-Welded with 75% Ar/25% CO <sub>2</sub>	0.006-0.008	2.01-2.13	0.005-0.007	3-4

**TYPICAL OPERATING PROCEDURES**

Diameter, Polarity Shielding Gas	CTWD <sup>(2)</sup> mm (in)	Wire Feed Speed m/min (in/min)	Voltage (volts)	Approx. Current (amps)	Melt-Off Rate kg/hr (lb/hr)	Deposition Rate kg/hr (lb/hr)	Efficiency (%)
0.045 in (1.1 mm), DC+ 75%-85% Ar/ balance CO <sub>2</sub>	25 (1)	4.4 (175)	21-26	140	1.8 (4.0)	1.6 (3.5)	86-88
		5.1 (200)	22-27	150	2.1 (4.6)	1.8 (4.0)	
		6.4 (250)	22-27	165	2.6 (5.7)	2.3 (5.0)	
		7.6 (300)	23-28	190	3.1 (6.8)	2.7 (6.0)	
		8.9 (350)	24-29	205	3.6 (8.0)	3.2 (7.0)	
		9.5 (375)	24-29	225	3.9 (8.6)	3.4 (7.5)	
		10.8 (425)	25-30	245	4.4 (9.7)	3.8 (8.5)	
		12.1 (475)	26-31	265	4.9 (10.8)	4.3 (9.5)	
0.052 in (1.3 mm), DC+ 75%-85% Ar/ balance CO <sub>2</sub>	25 (1)	3.8 (150)	21-26	150	2.0 (4.5)	1.8 (3.9)	86-88
		4.7 (185)	22-27	165	2.5 (5.5)	2.2 (4.8)	
		5.7 (225)	22-27	190	3.1 (6.7)	2.7 (5.9)	
		6.4 (250)	23-28	215	3.4 (7.5)	2.9 (6.5)	
		7.0 (275)	23-28	235	3.7 (8.2)	3.2 (7.2)	
		7.6 (300)	24-29	255	4.1 (9.0)	3.5 (7.8)	
		8.5 (335)	24-30	275	4.5 (10.0)	4.0 (8.7)	
		9.5 (375)	25-31	295	5.1 (11.2)	4.4 (9.8)	
1/16 in (1.6 mm), DC+ 75%-85% Ar/ balance CO <sub>2</sub>	25 (1)	3.8 (150)	21-27	200	2.9 (6.3)	2.5 (5.5)	86-88
		4.4 (175)	21-28	210	3.3 (7.4)	2.9 (6.4)	
		5.1 (200)	22-29	235	3.8 (8.4)	3.3 (7.3)	
		5.7 (225)	23-30	265	4.3 (9.5)	3.7 (8.2)	
		6.4 (250)	24-31	285	4.8 (10.5)	4.2 (9.2)	
		7.0 (275)	24-32	315	5.3 (11.6)	4.6 (10.1)	
		8.3 (325)	24-32	335	6.2 (13.7)	5.4 (11.9)	
		8.9 (350)	25-33	365	6.7 (14.7)	5.8 (12.8)	

<sup>(1)</sup>Typical all weld metal. <sup>(2)</sup>Measured with 0.2% offset. <sup>(3)</sup>See test results disclaimer <sup>(4)</sup>As-Welded with 75% Argon / 25% CO<sub>2</sub> <sup>(5)</sup>To estimate ESO, subtract 1/4 in (6.0 mm) from CTWD.



# ULTRACORE® 81Ni2C-H

Low Alloy, All Position ▪ AWS E81T1-Ni2C-JH4, E81T1-C1A6-Ni2-H4

## KEY FEATURES

- Capable of producing weld deposits with impact toughness exceeding 54 - 84 J (40 - 62 ft•lbf) at -51°C (-60°F)
- Designed for welding with 100% CO<sub>2</sub> shielding gas
- Premium arc performance and bead appearance
- H4 diffusible hydrogen levels
- ProTech® foil bag packaging

## WELDING POSITIONS

All, except vertical down

## SHIELDING GAS

100% CO<sub>2</sub>  
Flow Rate: 40-50 CFH

## CONFORMANCES

<b>AWS A5:</b>	E81T1-C1A6-Ni2-H4, E81T1-Ni2C-JH4
<b>ABS:</b>	3YSA H5
<b>CWB/CSA:</b>	E551T1-C1A5-Ni2-H4, E551T1-Ni2C-JH4
<b>DNV:</b>	III Y40MS H5
<b>Lloyd's Register:</b>	3YS H5
<b>ISO:</b>	T55 6 T1-1 C1 A-N5 H5

## TYPICAL APPLICATIONS

- Mining
- Offshore
- Bridge fabrication
- High strength fabrication

## DIAMETERS / PACKAGING

Diameter in (mm)	33 lb (15 kg) Spool*
0.045 (1.1)	ED032215
0.052 (1.3)	ED032278
1/16 (1.6)	ED032214

\*Spool may be plastic or fiber.

## MECHANICAL PROPERTIES<sup>(1)</sup>

	Yield Strength <sup>(2)</sup> MPa (ksi)	Tensile Strength MPa (ksi)	Elongation %	Charpy V-Notch J (ft•lbf)	
				@ -40°C (-40°F)	@ -51°C (-60°F)
<b>Requirements<sup>(4)</sup></b> - AWS E81T1-Ni2C-JH4	470 (68) min	550-670 (80-100)	19 min	27 (20) min	27 (20) min
<b>Typical Results<sup>(3)</sup></b> As-Welded with 100% CO <sub>2</sub>	555-600 (80-86)	615-650 (89-94)	26-28	76-111 (56-82)	54-84 (40-62)

**DEPOSIT COMPOSITION<sup>(1)</sup>**

	%C	%Mn	%Si	%S
<b>Requirements<sup>(4)</sup></b> - AWS E81T1-Ni2C-JH4	0.12 max	1.50 max	0.80 max	0.030 max
<b>Typical Results<sup>(3)</sup></b> As-Welded with 100% CO <sub>2</sub>	0.04-0.05	1.14-1.24	0.27-0.32	0.006-0.007
	%P	%Ni	%B	Diffusible Hydrogen (mL/100g weld deposit)
<b>Requirements<sup>(4)</sup></b> - AWS E81T1-Ni2C-JH4	0.030 max	1.75-2.75	Not Specified	4.0 max
<b>Typical Results<sup>(3)</sup></b> As-Welded with 100% CO <sub>2</sub>	0.006-0.007	1.86-2.19	0.005-0.006	2-4

**TYPICAL OPERATING PROCEDURES**

Diameter, Polarity Shielding Gas	CTWD <sup>(5)</sup> mm (in)	Wire Feed Speed m/min (in/min)	Voltage (volts)	Approx. Current (amps)	Melt-Off Rate kg/hr (lb/hr)	Deposition Rate kg/hr (lb/hr)	Efficiency (%)
0.045 in (1.1 mm), DC+ 100% CO <sub>2</sub>	25 (1)	4.4 (175)	23-28	140	1.8 (4.0)	1.6 (3.5)	86-88
		5.1 (200)	24-29	150	2.1 (4.6)	1.8 (4.0)	
		6.4 (250)	25-30	165	2.6 (5.7)	2.3 (5.0)	
		7.6 (300)	25-30	190	3.1 (6.8)	2.7 (6.0)	
		8.9 (350)	26-31	205	3.6 (8.0)	3.2 (7.0)	
		9.5 (375)	26-31	225	3.9 (8.6)	3.4 (7.5)	
		10.8 (425)	27-32	245	4.4 (9.7)	3.8 (8.5)	
		12.1 (475)	28-33	265	4.9 (10.8)	4.3 (9.5)	
0.052 in (1.3 mm), DC+ 100% CO <sub>2</sub>	25 (1)	3.8 (150)	23-28	150	2.0 (4.5)	1.8 (3.9)	86-88
		4.7 (185)	24-29	165	2.5 (5.5)	2.2 (4.8)	
		5.7 (225)	24-29	190	3.1 (6.7)	2.7 (5.9)	
		6.4 (250)	25-30	215	3.4 (7.5)	2.9 (6.5)	
		7.0 (275)	25-30	235	3.7 (8.2)	3.2 (7.2)	
		7.6 (300)	26-31	255	4.1 (9.0)	3.5 (7.8)	
		8.5 (335)	26-31	275	4.5 (10.0)	4.0 (8.7)	
		9.5 (375)	27-32	295	5.1 (11.2)	4.4 (9.8)	
1/16 in (1.6 mm), DC+ 100% CO <sub>2</sub>	25 (1)	3.8 (150)	24-29	200	2.9 (6.3)	2.5 (5.5)	86-88
		4.4 (175)	24-30	210	3.3 (7.4)	2.9 (6.4)	
		5.1 (200)	25-30	235	3.8 (8.4)	3.3 (7.3)	
		5.7 (225)	25-31	265	4.3 (9.5)	3.7 (8.2)	
		6.4 (250)	26-31	305	4.8 (10.5)	4.2 (9.2)	
		7.0 (275)	26-32	305	5.3 (11.6)	4.6 (10.1)	
		8.3 (325)	27-32	335	6.2 (13.7)	5.4 (11.9)	
		8.9 (350)	28-34	365	6.7 (14.7)	5.8 (12.8)	

<sup>(1)</sup>Typical all weld metal. <sup>(2)</sup>Measured with 0.2% offset. <sup>(3)</sup>See test results disclaimer <sup>(4)</sup>As-Welded with 100% CO<sub>2</sub>. <sup>(5)</sup>To estimate ESO, subtract 1/4 in (6.0 mm) from CTWD.

# ULTRACORE® 81K2A75-H

Low Alloy, All Position ▪ AWS E81T1-K2M-JH4, E81T1-M21A4-K2-H4

## KEY FEATURES

- Capable of producing weld deposits with impact toughness exceeding 89 - 127 J (66 - 94 ft•lbf) at -40°C (-40°F)
- Designed for welding with 75-85% Argon/ Balance CO<sub>2</sub> shielding gas
- Premium arc performance and bead appearance
- H4 diffusible hydrogen levels
- ProTech® foil bag packaging

## WELDING POSITIONS

All, except vertical down

## SHIELDING GAS

75% - 85% Argon / Balance CO<sub>2</sub>  
Flow Rate: 40 - 50 CFH

## CONFORMANCES

<b>AWS A5:</b>	E81T1-M21A6-Ni2-H4 E81T1-Ni2M-JH4
<b>ABS:</b>	3YSA H5
<b>CWB/CSA:</b>	E551T1-M21A5-Ni2-H4 E551T1-Ni2M-JH4
<b>DNV:</b>	III Y40MS H5
<b>Lloyd's Register:</b>	3YS H5
<b>ISO:</b>	T55 6 T1-1 M21 A-N5 H5

## TYPICAL APPLICATIONS

- High strength steels with 550 MPa (80 ksi) tensile strength
- Offshore
- Shipbuilding

## DIAMETERS / PACKAGING

Diameter in (mm)	33 lb (15 kg) Spool*
0.045 (1.1)	ED032385
0.052 (1.3)	ED032386
1/16 (1.6)	ED032387

\*Spool may be plastic or fiber.

## MECHANICAL PROPERTIES<sup>(1)</sup>

	Yield Strength <sup>(2)</sup> MPa (ksi)	Tensile Strength MPa (ksi)	Elongation %	Charpy V-Notch J (ft•lbf)	
				@ -29°C (-20°F)	@ -40°C (-40°F)
<b>Requirements<sup>(4)</sup></b> - AWS E81T1-K2M-JH4	470 (68) min	550-690 (80-100)	19 min	27 (20) min	27 (20) min
<b>Typical Results<sup>(3)</sup></b> As-Welded with 75% Argon/25% CO <sub>2</sub>	535-550 (78-80)	585-605 (85-88)	26-27	117-155 (86-114)	89-127 (66-94)

**DEPOSIT COMPOSITION<sup>(1)</sup>**

	%C	%Mn	%Si	%S	%P	%Ni
<b>Requirements<sup>(4)</sup></b> - AWS E81T1-K2M-JH4	0.15 max	0.50-1.75	0.80 max	0.030 max	0.030 max	1.00-2.00
<b>Typical Results<sup>(3)</sup></b> As-Welded with 75% Ar/25% CO <sub>2</sub>	0.04-0.05	0.98-1.09	0.25-0.28	0.006-0.009	0.005-0.008	1.40-1.63
	%Cr	%Mo	%V	%B	Diffusible Hydrogen (mL/100g weld deposit)	
<b>Requirements<sup>(4)</sup></b> - AWS E81T1-K2M-JH4	0.15 max	0.35 max	0.05 max	Not Specified	4 max	
<b>Typical Results<sup>(3)</sup></b> As-Welded with 75% Ar/25% CO <sub>2</sub>	0.03-0.04	0.01-0.02	0.02-0.03	0.005-0.007	2-4	

**TYPICAL OPERATING PROCEDURES**

Diameter, Polarity Shielding Gas	CTWD <sup>(5)</sup> mm (in)	Wire Feed Speed m/min (in/min)	Voltage (volts)	Approx. Current (amps)	Melt-Off Rate kg/hr (lb/hr)	Deposition Rate kg/hr (lb/hr)	Efficiency (%)
0.045 in (1.1 mm), DC+ 75%-85% Ar/ balance CO <sub>2</sub>	25 (1)	4.4 (175)	22-27	140	1.8 (4.0)	1.6 (3.5)	86-88
		5.1 (200)	23-28	150	2.1 (4.6)	1.8 (4.0)	
		6.4 (250)	24-29	165	2.6 (5.7)	2.3 (5.0)	
		7.6 (300)	24-29	190	3.1 (6.8)	2.7 (6.0)	
		8.9 (350)	25-30	205	3.6 (8.0)	3.2 (7.0)	
		9.5 (375)	25-30	225	3.9 (8.6)	3.4 (7.5)	
		10.8 (425)	26-31	245	4.4 (9.7)	3.8 (8.5)	
		12.1 (475)	27-32	265	4.9 (10.8)	4.3 (9.5)	
0.052 in (1.3 mm), DC+ 75%-85% Ar/ balance CO <sub>2</sub>	25 (1)	3.8 (150)	22-27	150	2.0 (4.5)	1.8 (3.9)	86-88
		4.7 (185)	23-28	165	2.5 (5.5)	2.2 (4.8)	
		5.7 (225)	23-28	190	3.1 (6.7)	2.7 (5.9)	
		6.4 (250)	24-29	215	3.4 (7.5)	2.9 (6.5)	
		6.9 (275)	24-29	235	3.7 (8.2)	3.2 (7.2)	
		7.6 (300)	25-30	255	4.1 (9.0)	3.5 (7.8)	
		8.5 (335)	25-31	275	4.5 (10.0)	4.0 (8.7)	
		9.5 (375)	26-32	295	5.1 (11.2)	4.4 (9.8)	
1/16 in (1.6 mm), DC+ 75%-85% Ar/ balance CO <sub>2</sub>	25 (1)	3.8 (150)	22-27	200	2.9 (6.3)	2.5 (5.5)	86-88
		4.4 (175)	23-28	210	3.3 (7.4)	2.9 (6.4)	
		5.1 (200)	24-29	235	3.8 (8.4)	3.3 (7.3)	
		5.7 (225)	24-29	265	4.3 (9.5)	3.7 (8.2)	
		6.4 (250)	25-30	285	4.8 (10.5)	4.2 (9.2)	
		6.9 (275)	25-31	315	5.3 (11.6)	4.6 (10.1)	
		8.3 (325)	26-32	335	6.2 (13.7)	5.4 (11.9)	
		8.9 (350)	27-33	365	6.7 (14.7)	5.8 (12.8)	

<sup>(1)</sup>Typical all weld metal. <sup>(2)</sup>Measured with 0.2% offset. <sup>(3)</sup>See test results disclaimer <sup>(4)</sup>As-Welded with 75% Argon/25% CO<sub>2</sub>. <sup>(5)</sup>To estimate ESO, subtract 1/4 in (6.0 mm) from CTWD.

# ULTRACORE® 81K2C-H

Low Alloy, All Position ▪ AWS E81T1-K2C-JH4, E81T1-C1A5-K2-H4

## KEY FEATURES

- Capable of producing weld deposits with impact toughness exceeding 111 - 141 J (82 - 104 ft•lbf) at -40°C (-40°F)
- Designed for welding with 100% CO<sub>2</sub> shielding gas
- Premium arc performance and bead appearance
- H4 diffusible hydrogen levels
- ProTech® foil bag packaging

## WELDING POSITIONS

All

## CONFORMANCES

<b>AWS A5.29:</b>	E81T1-K2C-JH4
<b>AWS A5.36:</b>	E81T1-C1A5-K2-H4
<b>ASME SFA-A5.29:</b>	E81T1-K2C-JH4
<b>ABS:</b>	4YQ460SA H5
<b>Lloyd's Register:</b>	4Y46S H5
<b>DNV Grade:</b>	IV 46MS H5
<b>EN ISO 17632-B:</b>	T554T1-1CA-N3-H5

## TYPICAL APPLICATIONS

- High strength steels with 550 MPa (80 ksi) tensile strength
- Offshore
- Shipbuilding

## SHIELDING GAS

100% CO<sub>2</sub>  
Flow Rate: 40 - 50 CFH

## DIAMETERS / PACKAGING

Diameter in (mm)	33 lb (15 kg) Spool*
0.045 (1.1)	ED032388
0.052 (1.3)	ED032389
1/16 (1.6)	ED032390

\*Spool may be plastic or fiber.

## MECHANICAL PROPERTIES<sup>(1)</sup>

	Yield Strength <sup>(2)</sup> MPa (ksi)	Tensile Strength MPa (ksi)	Elongation %	Charpy V-Notch J (ft•lbf)	
				@ -29°C (-20°F)	@ -40°C (-40°F)
<b>Requirements</b> - AWS E81T1-K2C-JH4 As-Welded with 100% CO <sub>2</sub>	470 (68) min	550-690 (80-100)	19 min	27 (20) min	27 (20) min
<b>Typical Results<sup>(3)</sup></b> As-Welded with 100% CO <sub>2</sub>	530-555 (77-80)	580-610 (84-88)	27-29	127-157 (94-116)	111-141 (82-104)

**DEPOSIT COMPOSITION<sup>(1)</sup>**

	%C	%Mn	%Si	%S	%P	%Ni
<b>Requirements<sup>(4)</sup></b> - AWS E81T1-K2C-JH4	0.15 max	0.50-1.75	0.80 max	0.030 max	0.030 max	1.00-2.00
<b>Typical Results<sup>(3)</sup></b> As-Welded with 100% CO <sub>2</sub>	0.04	1.08-1.15	0.23-0.31	0.005-0.009	0.005-0.009	1.30-1.62
	%Cr	%Mo	%V	%B	Diffusible Hydrogen (mL/100g weld deposit)	
<b>Requirements<sup>(4)</sup></b> - AWS E81T1-K2C-JH4	0.15 max	0.35 max	0.05 max	Not Specified	4.0 max	
<b>Typical Results<sup>(3)</sup></b> As-Welded with 100% CO <sub>2</sub>	0.03-0.05	0.01-0.02	0.01-0.02	0.005-0.006	2-3	

**TYPICAL OPERATING PROCEDURES**

Diameter, Polarity Shielding Gas	CTWD <sup>(2)</sup> mm (in)	Wire Feed Speed m/min (in/min)	Voltage (volts)	Approx. Current (amps)	Melt-Off Rate kg/hr (lb/hr)	Deposition Rate kg/hr (lb/hr)	Efficiency (%)
0.045 in (1.1 mm), DC+ 100% CO <sub>2</sub>	25 (1)	4.4 (175)	23-28	140	1.8 (4.0)	1.6 (3.5)	86-88
		5.1 (200)	24-29	150	2.1 (4.6)	1.8 (4.0)	
		6.4 (250)	25-30	165	2.6 (5.7)	2.3 (5.0)	
		7.6 (300)	25-30	190	3.1 (6.8)	2.7 (6.0)	
		8.9 (350)	26-31	205	3.6 (8.0)	3.2 (7.0)	
		9.5 (375)	26-31	225	3.9 (8.6)	3.4 (7.5)	
		10.8 (425)	27-32	245	4.4 (9.7)	3.8 (8.5)	
		12.1 (475)	28-33	265	4.9 (10.8)	4.3 (9.5)	
0.052 in (1.3 mm), DC+ 100% CO <sub>2</sub>	25 (1)	3.8 (150)	23-28	150	2.0 (4.5)	1.8 (3.9)	86-88
		4.7 (185)	24-29	165	2.5 (5.5)	2.2 (4.8)	
		5.7 (225)	24-29	190	3.1 (6.7)	2.7 (5.9)	
		6.4 (250)	25-30	215	3.4 (7.5)	2.9 (6.5)	
		6.9 (275)	25-30	235	3.7 (8.2)	3.2 (7.2)	
		7.6 (300)	26-31	255	4.1 (9.0)	3.5 (7.8)	
		8.5 (335)	26-31	275	4.5 (10.0)	4.0 (8.7)	
		9.5 (375)	27-32	295	5.1 (11.2)	4.4 (9.8)	
1/16 in (1.6 mm), DC+ 100% CO <sub>2</sub>	25 (1)	3.8 (150)	24-29	200	2.9 (6.3)	2.5 (5.5)	86-88
		4.4 (175)	24-30	210	3.3 (7.4)	2.9 (6.4)	
		5.1 (200)	25-30	235	3.8 (8.4)	3.3 (7.3)	
		5.7 (225)	25-31	265	4.3 (9.5)	3.7 (8.2)	
		6.4 (250)	26-31	285	4.8 (10.5)	4.2 (9.2)	
		6.9 (275)	26-32	305	5.3 (11.6)	4.6 (10.1)	
		8.3 (325)	27-32	335	6.2 (13.7)	5.4 (11.9)	
		8.9 (350)	28-34	365	6.7 (14.7)	5.8 (12.8)	

<sup>(1)</sup>Typical all weld metal. <sup>(2)</sup>Measured with 0.2% offset. <sup>(3)</sup>See test results disclaimer <sup>(4)</sup>As-Welded with 100% CO<sub>2</sub>. <sup>(5)</sup>To estimate ESO, subtract 1/4 in (6.0 mm) from CTWD.

# ULTRACORE® 81K2C-H PLUS

Low Alloy, All Positions ▪ AWS E81T1-K2C-JH4, E81T1-C1A6-K2-H4

## KEY FEATURES

- Innovative design capable of superior toughness at -60°F in both the as-welded and stress-relieved conditions
- Designed for welding with 100% CO<sub>2</sub> shielding gas
- H4 diffusible hydrogen levels
- Q2 Lot® - Certificate showing actual deposit chemistry and mechanical properties per lot available online
- ProTech® foil bag packaging

## WELDING POSITIONS

All

## CONFORMANCES

- AWS A5:** E81T1-C1A6-K2-H4, E81T1-C1P4-K2-H4, E81T1-K2C-JH4
- ABS:** 4YQ460SA H5
- DNV:** IV Y46MS H5
- Lloyd's Register:** 4Y46S H5

## TYPICAL APPLICATIONS

- Offshore drilling rigs
- Ship building
- Low temperature storage tanks
- Construction

## SHIELDING GAS

100% CO<sub>2</sub>  
Flow Rate: 40-50 CFH

## DIAMETERS / PACKAGING

Diameter in (mm)	33 lb (15kg) Plastic Spool
0.045 (1.1)	ED034864
0.052 (1.3)	ED034865
1/16 (1.6)	ED034866

## MECHANICAL PROPERTIES<sup>(1)</sup>

	Yield Strength <sup>(2)</sup> MPa (ksi)	Tensile Strength MPa (ksi)	Elongation (%)	Charpy V-Notch J (ft-lbf)	
				-40°C (-40°F)	-51°C (-60°F)
<b>Requirements</b> AWS A5.29: E81T1-K2C-JH4 As-Welded with 100% CO <sub>2</sub>	470 (68) min	550-690 (80-100)	19 min	27 (20) min	-
AWS A5.36: E81T1-C1A6-K2-H4 As-Welded with 100% CO <sub>2</sub>	470 (68) min	550-690 (80-100)	19 min	-	27 (20) min
AWS A5.36: E81T1-C1P4-K2-H4 Stress Relieved with 100% CO <sub>2</sub> for 1 hr @ 621°C (1150°F)	470 (68) min	550-690 (80-100)	19 min	27 (20) min	-
<b>Typical Results<sup>(3)</sup></b> As-Welded with 100% CO <sub>2</sub>	491-531 (71-77)	576-604 (84-88)	24-26	107-117 (79-86)	119-135 (88-100)
Stress Relieved with 100% CO <sub>2</sub> for 1 hr @ 621°C (1150°F)	477-488 (69-71)	575-580 (83-84)	27	120-147 (89-108)	-

<sup>(1)</sup> Typical all weld metal. <sup>(2)</sup> Measure with 0.2% offset. <sup>(3)</sup> See test results disclaimer

**DEPOSIT COMPOSITION<sup>(1)</sup>**

	%C	%Mn	%Si	%S	%P	%Ni
<b>Requirements</b> AWS A5.29: E81T1-K2C-JH4 AWS A5.36: E81T1-C1A6-K2-H4, E81T1-C1P4-K2-H4	0.15 max	0.50-1.75	0.80 max	0.030 max	0.030 max	1.00-2.00
<b>Typical Results<sup>(3)</sup></b>	0.05	1.39-1.56	0.30-0.36	0.007-0.008	0.013	1.54-1.72
	%Cr	%Mo	%V	%B	Diffusible Hydrogen (mL/100g weld deposit)	
<b>Requirements</b> AWS A5.29: E81T1-K2C-JH4 AWS A5.36: E81T1-C1A6-K2-H4, E81T1-C1P4-K2-H4	0.15 max	0.35 max	0.05 max	Not Specified	4.0 max	
<b>Test Results<sup>(3)</sup></b>	0.07	0.02	0.01	0.004-0.005	4 max	
					2-4	

**TYPICAL OPERATING PROCEDURES**

Diameter, Polarity Shielding Gas	CTWD <sup>(4)</sup> mm (in)	Wire Feed Speed m/min (in/min)	Voltage (volts)	Approx. Current (amps)	Melt-Off Rate kg/hr (lb/hr)	Deposition Rate kg/hr (lb/hr)	Efficiency (%)
0.045 in (1.1 mm), DC+	19 (3/4)	4.4 (175)	25 - 29	120	1.8 (3.9)	1.5 (3.4)	85-87
	19 (3/4)	6.4 (250)	26 - 30	140	2.5 (5.6)	2.2 (4.8)	
	19 (3/4)	7.6 (300)	27 - 31	155	3.1 (6.8)	2.6 (5.8)	
	19 (3/4)	8.9 (350)	28 - 32	170	3.6 (7.9)	3.1 (6.8)	
	25 (1)	10.2 (400)	29 - 33	185	4.1 (9.0)	3.5 (7.8)	
	25 (1)	11.4 (450)	29 - 33	200	4.6 (10.1)	4.0 (8.8)	
0.052 in (1.3 mm), DC+	19 (3/4)	3.8 (150)	25 - 29	150	2.1 (4.7)	1.7 (3.8)	81-84
	19 (3/4)	5.1 (200)	26 - 30	170	2.9 (6.3)	2.4 (5.2)	
	19 (3/4)	6.4 (250)	27 - 31	195	3.5 (7.8)	3.0 (6.5)	
	25 (1)	7.6 (300)	28 - 32	215	4.3 (9.4)	3.6 (7.9)	
	25 (1)	8.9 (350)	29 - 33	240	5.0 (11.0)	4.2 (9.2)	
1/16 in (1.6 mm), DC+	19 (3/4)	3.8 (150)	26 - 30	190	2.9 (6.4)	2.4 (5.3)	83-87
	19 (3/4)	4.4 (175)	26 - 30	205	3.4 (7.5)	2.9 (6.3)	
	19 (3/4)	5.1 (200)	27 - 31	220	3.9 (8.5)	3.3 (7.2)	
	19 (3/4)	5.7 (225)	27 - 31	230	4.4 (9.6)	3.7 (8.1)	
	19 (3/4)	6.4 (250)	28 - 32	245	4.8 (10.6)	4.1 (9.1)	
	25 (1)	7.6 (300)	28 - 32	275	5.8 (12.7)	4.9 (10.9)	
	25 (1)	8.3 (325)	29 - 33	290	6.3 (13.8)	5.4 (11.9)	
	25 (1)	8.9 (350)	29 - 33	300	6.7 (14.8)	5.8 (12.8)	

<sup>(1)</sup> Typical all weld metal. <sup>(2)</sup> Measure with 0.2% offset. <sup>(3)</sup> See test results disclaimer <sup>(4)</sup> To estimate ESO, subtract 1/4 in (6.0 mm) from CTWD.



# ULTRACORE® 81K2M-H PLUS

Low Alloy, All Positions ▪ AWS E81T1-K2M-JH4, E81T1-M21A6-K2-H4

## KEY FEATURES

- Innovative design capable of superior toughness at -60°F in both the as-welded and stress-relieved conditions
- Designed for welding with 75-80% Argon/ Balance CO<sub>2</sub> shielding gas
- H4 diffusible hydrogen levels
- Q2 Lot® - Certificate showing actual deposit chemistry and mechanical properties per lot available online
- ProTech® foil bag packaging

## CONFORMANCES

**AWS A5:** E81T1-K2M-JH4, E81T1-M21A6-K2-H4, E81T1-M21P4-K2-H4

## TYPICAL APPLICATIONS

- Offshore drilling rigs
- Low temperature storage tanks
- Ship building
- Construction

## WELDING POSITIONS

All

## SHIELDING GAS

75-80% Argon / Balance CO<sub>2</sub>  
Flow Rate: 40-50 CFH

## DIAMETERS / PACKAGING

Diameter in (mm)	33 lb (15kg) Plastic Spool
0.045 (1.1)	ED034861
0.052 (1.3)	ED034862
1/16 (1.6)	ED034863

## MECHANICAL PROPERTIES<sup>(1)</sup>

	Yield Strength <sup>(2)</sup> MPa (ksi)	Tensile Strength MPa (ksi)	Elongation (%)	Charpy V-Notch J (ft·lbf)	
				-40°C (-40°F)	-51°C (-60°F)
<b>Requirements</b> AWS A5.29: E81T1-K2M-JH4 As-Welded with 75% Ar / 25% CO <sub>2</sub>	470 (68) min	550-690 (80-100)	19 min	27 (20) min	-
AWS A5.36: E81T1-M21A6-K2-H4 As-Welded with 75% Ar / 25% CO <sub>2</sub>	470 (68) min	550-690 (80-100)	19 min	-	27 (20) min
AWS A5.36: E81T1-M21P4-K2-H4 Stress Relieved with 75% Ar / 25% CO <sub>2</sub> for 1 hr @ 621°C (1150°F)	470 (68) min	550-690 (80-100)	19 min	27 (20) min	-
<b>Typical Results<sup>(3)</sup></b> As-Welded with 75% Ar / 25% CO <sub>2</sub>	503-550 (73-80)	588-628 (85-91)	21-24	107-117 (79-86)	97-111 (72-82)
Stress Relieved with 75% Ar / 25% CO <sub>2</sub> for 1 hr @ 621°C (1150°F)	480-490 (69-71)	570-590 (83-85)	27-29	81-94 (60-70)	-

<sup>(1)</sup> Typical all weld metal. <sup>(2)</sup> Measure with 0.2% offset. <sup>(3)</sup> See test results disclaimer

**DEPOSIT COMPOSITION<sup>(1)</sup>**

	%C	%Mn	%Si	%S	%P	%Ni
<b>Requirements</b> AWS A5.29: E81T1-K2M-JH4 AWS A5.36: E81T1-M21A6-K2-H4, E81T1-M21P4-K2-H4	0.15 max	0.50-1.75	0.80 max	0.030 max	0.030 max	1.00-2.00
<b>Typical Results<sup>(3)</sup></b> with 75% Argon / 25% CO <sub>2</sub>	0.05	1.28-1.30	0.42-0.44	0.007-0.009	0.011	1.45-1.60
	%Cr	%Mo	%V	%B	Diffusible Hydrogen (mL/100g weld deposit)	
<b>Requirements</b> AWS A5.29: E81T1-K2M-JH4 AWS A5.36: E81T1-M21A6-K2-H4, E81T1-M21P4-K2-H4	0.15 max	0.35 max	0.05 max	Not Specified	4.0 max	
<b>Typical Results<sup>(3)</sup></b> with 75% Argon / 25% CO <sub>2</sub>	0.05	0.01	0.00	0.005-0.006	4 max	
					2-4	

**TYPICAL OPERATING PROCEDURES**

Diameter, Polarity Shielding Gas	CTWD <sup>(4)</sup> mm (in)	Wire Feed Speed m/min (in/min)	Voltage (volts)	Approx. Current (amps)	Melt-Off Rate kg/hr (lb/hr)	Deposition Rate kg/hr (lb/hr)	Efficiency (%)
0.045 in (1.1 mm), DC+	19 (3/4)	4.4 (175)	24 - 28	120	1.8 (3.9)	1.5 (3.4)	85-87
	19 (3/4)	6.4 (250)	25 - 29	140	2.5 (5.6)	2.2 (4.8)	
	19 (3/4)	7.6 (300)	26 - 30	155	3.1 (6.8)	2.6 (5.8)	
	19 (3/4)	8.9 (350)	27 - 31	170	3.6 (7.9)	3.1 (6.8)	
	25 (1)	10.2 (400)	28 - 32	185	4.1 (9.0)	3.5 (7.8)	
	25 (1)	11.4 (450)	28 - 32	200	4.6 (10.1)	4.0 (8.8)	
0.052 in (1.3 mm), DC+	19 (3/4)	3.8 (150)	24 - 28	150	2.1 (4.7)	1.7 (3.8)	81-84
	19 (3/4)	5.1 (200)	25 - 29	170	2.9 (6.3)	2.4 (5.2)	
	19 (3/4)	6.4 (250)	26 - 30	195	3.5 (7.8)	3.0 (6.5)	
	25 (1)	7.6 (300)	27 - 31	215	4.3 (9.4)	3.6 (7.9)	
	25 (1)	8.9(350)	28 - 32	240	5.0 (11.0)	4.2 (9.2)	
1/16 in (1.6 mm), DC+	19 (3/4)	3.8 (150)	25 - 29	190	2.9 (6.4)	2.4 (5.3)	83-87
	19 (3/4)	4.4 (175)	25 - 29	205	3.4 (7.5)	2.9 (6.3)	
	19 (3/4)	5.1 (200)	26 - 30	220	3.9 (8.5)	3.3 (7.2)	
	19 (3/4)	5.7 (225)	26 - 30	230	4.4 (9.6)	3.7 (8.1)	
	19 (3/4)	6.4 (250)	27 - 31	245	4.8 (10.6)	4.1 (9.1)	
	25 (1)	7.6 (300)	27 - 31	275	5.8 (12.7)	4.9 (10.9)	
	25 (1)	8.3 (325)	28 - 32	290	6.3 (13.8)	5.4 (11.9)	
25 (1)	8.9 (350)	28 - 32	300	6.7 (14.8)	5.8 (12.8)		

<sup>(1)</sup> Typical all weld metal. <sup>(2)</sup> Measure with 0.2% offset. <sup>(3)</sup> See test results disclaimer. <sup>(4)</sup> To estimate ESO, subtract 1/4 in (6.0 mm) from CTWD.

# ULTRACORE® 91K2C-H PLUS

Low Alloy, All Positions ▪ AWS E91T1-K2C-JH4, E91T1-C1A6-K2-H4

## KEY FEATURES

- Innovative design capable of superior toughness at -60°F in both the as-welded and stress-relieved conditions
- Designed for welding with 100% CO<sub>2</sub> shielding gas
- H4 diffusible hydrogen levels
- Q2 Lot® - Certificate showing actual deposit chemistry and mechanical properties per lot available online
- ProTech® foil bag packaging

## WELDING POSITIONS

All

## CONFORMANCES

- AWS A5:** E91T1-C1A6-K2-H4, E91T1-C1P4-K2-H4, E91T1-K2C-JH4
- ABS:** 4YQ500SA H5
- DNV:** IV Y50MS H5
- Lloyd's Register:** 4Y50S H5

## TYPICAL APPLICATIONS

- Offshore drilling rigs
- Low temperature storage tanks
- Ship building
- Construction

## SHIELDING GAS

100% CO<sub>2</sub>  
Flow Rate: 40-50 CFH

## DIAMETERS / PACKAGING

Diameter in (mm)	33 lb (15kg) Fiber Spool (Plastic Bag)
0.045 (1.1)	ED035381
0.052 (1.3)	ED035382
1/16 (1.6)	ED035383

## MECHANICAL PROPERTIES<sup>(1)</sup>

	Yield Strength <sup>(2)</sup> MPa (ksi)	Tensile Strength MPa (ksi)	Elongation (%)	Charpy V-Notch J (ft-lbf)	
				-40°C (-40°F)	-51°C (-60°F)
<b>Requirements</b> AWS A5.29 E91T1-K2C-JH4 As-Welded with 100% CO <sub>2</sub>	540 (78) min	620-760 (90-110)	17 min	27 (20) min	-
AWS A5.36 E91T1-C1A6-K2-H4 As-Welded with 100% CO <sub>2</sub>	540 (78) min	620-760 (90-110)	17 min	-	27 (20) min
AWS A5.36 E91T1-C1P4-K2-H4 Stress Relieved with 100% CO <sub>2</sub> for 1 hr @ 620°C (1150°F)	540 (78) min	620-760 (90-110)	17 min	27 (20) min	-
<b>Typical Results<sup>(3)</sup></b> As-Welded with 100% CO <sub>2</sub>	610-650 (88-94)	665-680 (96-99)	23-25	85-93 (63-69)	75-80 (55-59)
Stress Relieved with 100% CO <sub>2</sub> for 1 hr @ 620°C (1150°F)	580-610 (84-88)	650-675 (94-98)	23-29	85-93 (63-69)	-

<sup>(1)</sup> Typical all weld metal. <sup>(2)</sup> Measure with 0.2% offset. <sup>(3)</sup> See test results disclaimer

**DEPOSIT COMPOSITION<sup>(1)</sup>**

	%C	%Mn	%Si	%S	%P	%Ni
<b>Requirements</b> AWS A5.29 E91T1-K2C-JH4 AWS A5.36 E91T1-C1A6-K2-H4, E91T1-C1P4-K2-H4	0.15 max	0.50-1.75	0.80 max	0.030 max	0.030 max	1.00-2.00
<b>Typical Results<sup>(3)</sup></b> As-Welded with 100% CO <sub>2</sub>	0.04-0.07	1.39-1.73	0.25-0.35	0.006-0.008	0.009-0.011	1.33-1.66
	%Cr	%Mo	%V	%B	Diffusible Hydrogen (mL/100g weld deposit)	
<b>Requirements</b> AWS A5.29 E91T1-K2C-JH4 AWS A5.36 E91T1-C1A6-K2-H4, E91T1-C1P4-K2-H4	0.15 max	0.35 max	0.05 max	Not Specified	4.0 max	
<b>Typical Results<sup>(3)</sup></b> As-Welded with 100% CO <sub>2</sub>	0.04-0.05	0.22-0.29	0.00	0.003-0.004	4 max	
					1-3	

**TYPICAL OPERATING PROCEDURES**

Diameter, Polarity Shielding Gas	CTWD <sup>(4)</sup> mm (in)	Wire Feed Speed m/min (in/min)	Voltage (volts)	Approx. Current (amps)	Melt-Off Rate kg/hr (lb/hr)	Deposition Rate kg/hr (lb/hr)	Efficiency (%)
0.045 in (1.1 mm), DC+	19 (3/4)	4.4 (175)	25 - 29	130	1.9 (4.1)	1.7 (3.7)	89-90
	19 (3/4)	6.4 (250)	27 - 31	170	2.6 (5.8)	2.4 (5.2)	
	19 (3/4)	7.6 (300)	28 - 32	195	3.2 (7.0)	2.8 (6.2)	
	19 (3/4)	8.9 (350)	28 - 32	220	3.7 (8.1)	3.3 (7.2)	
	25 (1)	10.2 (400)	28 - 32	225	4.2 (9.2)	3.7 (8.2)	
	25 (1)	11.4 (450)	29 - 33	245	4.7 (10.4)	4.2 (9.2)	
	25 (1)	12.7 (500)	30 - 34	265	5.2 (11.5)	4.6 (10.2)	
0.052 in (1.3 mm), DC+	19 (3/4)	3.8 (150)	26 - 30	160	2.1 (4.6)	1.7 (3.8)	82-84
	19 (3/4)	4.4 (175)	26 - 30	180	2.4 (5.4)	2.0 (4.5)	
	19 (3/4)	5.1 (200)	27 - 31	200	2.8 (6.2)	2.3 (5.1)	
	19 (3/4)	5.7 (225)	27 - 31	220	3.2 (7.0)	2.6 (5.8)	
	19 (3/4)	7.0 (275)	28 - 32	255	3.9 (8.5)	3.2 (7.1)	
	25 (1)	7.6 (300)	28 - 32	230	4.2 (9.3)	3.5 (7.8)	
	25 (1)	8.3 (325)	28 - 32	245	4.6 (10.1)	3.8 (8.4)	
25 (1)	8.9 (350)	29 - 33	255	4.9 (10.9)	4.1 (9.1)		
1/16 in (1.6 mm), DC+	19 (3/4)	3.8 (150)	26 - 30	205	2.9 (6.3)	2.4 (5.2)	83-85
	19 (3/4)	4.4 (175)	27 - 31	230	3.4 (7.4)	2.8 (6.2)	
	19 (3/4)	5.1 (200)	27 - 31	250	3.8 (8.4)	3.2 (7.1)	
	19 (3/4)	5.7 (225)	28 - 32	270	4.3 (9.5)	3.6 (8.0)	
	19 (3/4)	7.0 (275)	28 - 32	305	5.3 (11.6)	4.4 (9.8)	
	25 (1)	7.6 (300)	28 - 32	305	5.8 (12.7)	4.9 (10.7)	
	25 (1)	8.3 (325)	29 - 33	320	6.2 (13.7)	5.3 (11.6)	
25 (1)	8.9 (350)	29 - 33	335	6.7 (14.8)	5.7 (12.6)		

<sup>(1)</sup> Typical all weld metal. <sup>(2)</sup> Measure with 0.2% offset. <sup>(3)</sup> See test results disclaimer. <sup>(4)</sup> To estimate ESO, subtract 1/4 in (6.0 mm) from CTWD.

# ULTRACORE® 91K2M-H PLUS

Low Alloy, All Positions ▪ AWS E91T1-K2M-JH4, E91T1-M21A6-K2-H4

## KEY FEATURES

- Innovative design capable of superior toughness at -60°F in both the as-welded and stress-relieved conditions
- Designed for welding with 75-80% Argon/ Balance CO<sub>2</sub> shielding gas
- H4 diffusible hydrogen levels
- Q2 Lot® - Certificate showing actual deposit chemistry and mechanical properties per lot available online
- ProTech® foil bag packaging

## WELDING POSITIONS

All

## CONFORMANCES

- AWS A5:** E91T1-K2M-JH4, E91T1-M21A6-K2-H4, E91T1-M21P4-K2-H4
- ABS:** 4YQ500SA H5
- CWB/CSA:** E621T1-M21A5-K2-H4, E91T1-M21A6-K2-H4
- DNV:** IV Y50MS H5
- Lloyd's Register:** 4Y50S H5

## TYPICAL APPLICATIONS

- Offshore drilling rigs
- Ship building
- Low temperature storage tanks
- Construction

## SHIELDING GAS

75-80% Argon / Balance CO<sub>2</sub>  
Flow Rate: 40-50 CFH

## DIAMETERS / PACKAGING

Diameter in (mm)	33 lb (15 kg) Fiber Spool (Plastic Bag)
0.045 (1.1)	ED035378
0.052 (1.3)	ED035379
1/16 (1.6)	ED035380

## MECHANICAL PROPERTIES<sup>(1)</sup>

	Yield Strength <sup>(2)</sup> MPa (ksi)	Tensile Strength MPa (ksi)	Elongation (%)	Charpy V-Notch J (ft-lbf)	
				-40°C (-40°F)	-51°C (-60°F)
<b>Requirements</b>					
AWS A5.29 E91T1-K2M-JH4 As-Welded with 75% Ar / 25% CO <sub>2</sub>	540 (78) min	620-760 (90-110)	17 min	27 (20) min	-
AWS A5.36 E91T1-M21A6-K2-H4 As-Welded with 75% Ar / 25% CO <sub>2</sub>	540 (78) min	620-760 (90-110)	17 min	-	27 (20) min
AWS A5.36 E91T1-M21P4-K2-H4 Stress Relieved with 75% Ar / 25% CO <sub>2</sub> for 1 hr @ 620°C (1150°F)	540 (78) min	620-760 (90-110)	17 min	27 (20) min	-
<b>Typical Results<sup>(3)</sup></b>					
As-Welded with 75% Argon / 25% CO <sub>2</sub>	615-630 (89-91)	670-685 (97-99)	23-24	84-88 (62-65)	65-69 (48-51)
Stress Relieved with 75% Ar / 25% CO <sub>2</sub> for 1 hr @ 620°C (1150°F)	570-585 (83-85)	635-655 (92-95)	24-27	84-88 (62-65)	-

<sup>(1)</sup> Typical all weld metal. <sup>(2)</sup> Measure with 0.2% offset. <sup>(3)</sup> See test results disclaimer

**DEPOSIT COMPOSITION<sup>(1)</sup>**

	%C	%Mn	%Si	%S	%P	%Ni
<b>Requirements</b> AWS A5.29 E91T1-K2M-JH4 AWS A5.36 E91T1-M21A6-K2-H4, E91T1-M21P4-K2-H4	0.15 max	0.50-1.75	0.80 max	0.030 max	0.030 max	1.00-2.00
<b>Typical Results<sup>(3)</sup></b> As-Welded with 75% Argon / 25% CO <sub>2</sub>	0.04-0.05	1.50-1.66	0.30-0.35	0.006-0.012	0.008-0.010	1.44-1.58
	%Cr	%Mo	%V	%B	Diffusible Hydrogen (mL/100g weld deposit)	
<b>Requirements</b> AWS A5.29 E91T1-K2M-JH4 AWS A5.36 E91T1-M21A6-K2-H4, E91T1-M21P4-K2-H4	0.15 max	0.35 max	0.05 max	Not Specified	4.0 max	
					4 max	
<b>Typical Results<sup>(3)</sup></b> As-Welded with 75% Argon / 25% CO <sub>2</sub>	0.04-0.05	0.24-0.27	0.00	0.004-0.005	1-3	

**TYPICAL OPERATING PROCEDURES**

Diameter, Polarity Shielding Gas	CTWD <sup>(4)</sup> mm (in)	Wire Feed Speed m/min (in/min)	Voltage (volts)	Approx. Current (amps)	Melt-Off Rate kg/hr (lb/hr)	Deposition Rate kg/hr (lb/hr)	Efficiency (%)
0.045 in (1.1 mm), DC+	19 (3/4)	4.4 (175)	25 - 28	130	1.9 (4.1)	1.7 (3.7)	89-90
	19 (3/4)	6.4 (250)	27 - 30	170	2.6 (5.8)	2.4 (5.2)	
	19 (3/4)	7.6 (300)	28 - 31	195	3.2 (7.0)	2.8 (6.2)	
	19 (3/4)	8.9 (350)	29 - 32	220	3.7 (8.1)	3.3 (7.2)	
	25 (1)	10.2 (400)	29 - 32	225	4.2 (9.2)	3.7 (8.2)	
	25 (1)	11.4 (450)	30 - 33	245	4.7 (10.4)	4.2 (9.2)	
	25 (1)	12.7 (500)	30 - 33	265	5.2 (11.5)	4.6 (10.2)	
0.052 in (1.3 mm), DC+	19 (3/4)	3.8 (150)	26 - 29	160	2.1 (4.6)	1.7 (3.8)	82-84
	19 (3/4)	4.4 (175)	26 - 29	180	2.4 (5.4)	2.0 (4.5)	
	19 (3/4)	5.1 (200)	27 - 30	200	2.8 (6.2)	2.3 (5.1)	
	19 (3/4)	5.7 (225)	27 - 30	220	3.2 (7.0)	2.6 (5.8)	
	19 (3/4)	7.0 (275)	28 - 31	255	3.9 (8.5)	3.2 (7.1)	
	25 (1)	7.6 (300)	28 - 31	230	4.2 (9.3)	3.5 (7.8)	
	25 (1)	8.3 (325)	28 - 31	245	4.6 (10.1)	3.8 (8.4)	
25 (1)	8.9 (350)	29 - 32	255	4.9 (10.9)	4.1 (9.1)		
1/16 in (1.6 mm), DC+	19 (3/4)	3.8 (150)	26 - 29	205	2.9 (6.3)	2.4 (5.2)	83-85
	19 (3/4)	4.4 (175)	27 - 30	230	3.4 (7.4)	2.8 (6.2)	
	19 (3/4)	5.1 (200)	27 - 30	250	3.8 (8.4)	3.2 (7.1)	
	19 (3/4)	5.7 (225)	28 - 31	270	4.3 (9.5)	3.6 (8.0)	
	19 (3/4)	7.0 (275)	29 - 32	305	5.3 (11.6)	4.4 (9.8)	
	25 (1)	7.6 (300)	29 - 32	305	5.8 (12.7)	4.9 (10.7)	
	25 (1)	8.3 (325)	29 - 32	320	6.2 (13.7)	5.3 (11.6)	
25 (1)	8.9 (350)	29 - 32	335	6.7 (14.8)	5.7 (12.6)		

<sup>(1)</sup> Typical all weld metal. <sup>(2)</sup> Measure with 0.2% offset. <sup>(3)</sup> See test results disclaimer. <sup>(4)</sup> To estimate ESO, subtract 1/4 in (6.0 mm) from CTWD.

# ULTRACORE® 101K3M-H PLUS

Low Alloy, All Positions ▪ AWS E101T1-K3M-JH4, E101T1-M21A6-K3-H4

## KEY FEATURES

- Innovative design capable of superior toughness at -60°F in both the as-welded and stress-relieved conditions
- Designed for welding with 75-80% Argon/ Balance CO<sub>2</sub> shielding gas
- H4 diffusible hydrogen levels
- Q2 Lot® - Certificate showing actual deposit chemistry and mechanical properties per lot available online
- ProTech® foil bag packaging

## CONFORMANCES

- AWS A5:** E101T1-M21A6-K3-H4 E91T1-M21P4-K3-H4  
E101T1-K3M-JH4
- ABS:** E101T1-K3M-JH4, E101T1-M21A6-K3-H4

## TYPICAL APPLICATIONS

- Offshore drilling rigs
- Ship building
- Low temperature storage tanks
- Construction

## WELDING POSITIONS

All

## SHIELDING GAS

75-80% Argon / Balance CO<sub>2</sub>  
Flow Rate: 40-50 CFH

## DIAMETERS / PACKAGING

Diameter in (mm)	33 lb (15 kg) Fiber Spool (Plastic Bag)
0.045 (1.1)	ED035413
0.052 (1.3)	ED035414

## MECHANICAL PROPERTIES<sup>(1)</sup>

	Yield Strength <sup>(2)</sup> MPa (ksi)	Tensile Strength MPa (ksi)	Elongation (%)	Charpy V-Notch J (ft·lbf)	
				-40°C (-40°F)	-51°C (-60°F)
<b>Requirements</b>					
AWS A5.29 E101T1-K3M-JH4 As-Welded with 75% Ar / 25% CO <sub>2</sub>	605 (88) min	690-825 (100-120)	16 min	27 (20) min	-
AWS A5.36 E101T1-M21A6-K3-H4 As-Welded with 75% Ar / 25% CO <sub>2</sub>	605 (88) min	690-825 (100-120)	16 min	-	27 (20) min
AWS A5.36 E91T1-M21P4-K3-H4 Stress Relieved with 75% Ar / 25% CO <sub>2</sub> for 1 hr @ 620°C (1150°F)	540 (78) min	620-760 (90-110)	17 min	27 (20) min	-
<b>Typical Results<sup>(3)</sup></b>					
As-Welded with 75% Argon / 25% CO <sub>2</sub>	695-710 (100-103)	740-765 (108-111)	21-23	55-60 (40-44)	48-53 (35-39)
Stress Relieved with 75% Ar / 25% CO <sub>2</sub> for 1 hr @ 620°C (1150°F)	655-670 (95-97)	720-730 (104-106)	22-23	55-60 (40-44)	-

<sup>(1)</sup> Typical all weld metal. <sup>(2)</sup> Measure with 0.2% offset. <sup>(3)</sup> See test results disclaimer

**DEPOSIT COMPOSITION<sup>(1)</sup>**

	%C	%Mn	%Si	%S	%P	%Ni
<b>Requirements</b> AWS A5.29 E101T1-K3M-JH4 AWS A5.36 E101T1-M21A6-K3-H4, E91T1-M21P4-K3-H4	0.15 max	0.75-2.25	0.80 max	0.030 max	0.030 max	1.25-2.60
<b>Typical Results<sup>(3)</sup></b> As-Welded with 75% Argon / 25% CO <sub>2</sub>	0.04-0.05	1.60-1.71	0.33-0.34	0.007-0.008	0.010-0.011	1.89-2.17
	%Cr	%Mo	%V	%B	Diffusible Hydrogen (mL/100g weld deposit)	
<b>Requirements</b> AWS A5.29 E101T1-K3M-JH4 AWS A5.36 E101T1-M21A6-K3-H4, E91T1-M21P4-K3-H4	0.15 max	0.25-0.65	0.05 max	Not Specified	4.0 max	
<b>Typical Results<sup>(3)</sup></b> As-Welded with 75% Argon / 25% CO <sub>2</sub>	0.04-0.06	0.39-0.44	0.00	0.004-0.005	4 max	
					1-3	

**TYPICAL OPERATING PROCEDURES**

Diameter, Polarity Shielding Gas	CTWD <sup>(4)</sup> mm (in)	Wire Feed Speed m/min (in/min)	Voltage (volts)	Approx. Current (amps)	Melt-Off Rate kg/hr (lb/hr)	Deposition Rate kg/hr (lb/hr)	Efficiency (%)
0.045 in (1.1 mm), DC+	19 (3/4)	4.4 (175)	24 - 28	120	1.8 (3.9)	1.5 (3.4)	85-87
	19 (3/4)	6.4 (250)	25 - 29	140	2.5 (5.6)	2.2 (4.8)	
	19 (3/4)	7.6 (300)	26 - 30	155	3.1 (6.8)	2.6 (5.8)	
	19 (3/4)	8.9 (350)	27 - 31	170	3.6 (7.9)	3.1 (6.8)	
	25 (1)	10.2 (400)	28 - 32	185	4.1 (9.0)	3.5 (7.8)	
	25 (1)	11.4 (450)	28 - 32	200	4.6 (10.1)	4.0 (8.8)	
	25 (1)	12.7 (500)	29 - 33	220	5.1 (11.3)	4.4 (9.8)	
0.052 in (1.3 mm), DC+	19 (3/4)	3.8 (150)	26 - 29	160	2.1 (4.6)	1.7 (3.8)	82-84
	19 (3/4)	4.4 (175)	26 - 29	180	2.4 (5.4)	2.0 (4.5)	
	19 (3/4)	5.1 (200)	27 - 30	200	2.8 (6.2)	2.3 (5.1)	
	19 (3/4)	5.7 (225)	27 - 30	220	3.2 (7.0)	2.6 (5.8)	
	19 (3/4)	7.0 (275)	28 - 31	255	3.9 (8.5)	3.2 (7.1)	
	25 (1)	7.6 (300)	28 - 31	230	4.2 (9.3)	3.5 (7.8)	
	25 (1)	8.3 (325)	28 - 31	245	4.6 (10.1)	3.8 (8.4)	
	25 (1)	8.9 (350)	29 - 32	255	4.9 (10.9)	4.1 (9.1)	

<sup>(1)</sup> Typical all weld metal. <sup>(2)</sup> Measure with 0.2% offset. <sup>(3)</sup> See test results disclaimer. <sup>(4)</sup> To estimate ESO, subtract 1/4 in (6.0 mm) from CTWD.



# ULTRACORE® 111K3C-H PLUS

Low Alloy, All Positions ▪ AWS E111T1-K3C-JH4, E111T1-C1A6-K3-H4

## KEY FEATURES

- Innovative design capable of superior toughness at -60°F in both the as-welded and stress-relieved conditions
- Designed for welding with 100% CO<sub>2</sub> shielding gas
- H4 diffusible hydrogen levels
- Q2 Lot® - Certificate showing actual deposit chemistry and mechanical properties per lot available online
- ProTech® foil bag packaging

## WELDING POSITIONS

All

## CONFORMANCES

<b>AWS A5.29:</b>	E101T1-K3M-JH4
<b>AWS A5.36:</b>	E101T1-M21A6-K3-H4
<b>AWS A5.36:</b>	E91T1-M21P4-K3-H4
<b>ABS:</b>	E101T1-K3M-JH4, E101T1-M21A6-K3-H4

## TYPICAL APPLICATIONS

- Offshore drilling rigs
- Low temperature storage tanks
- Ship building
- Construction

## SHIELDING GAS

100% CO<sub>2</sub>  
Flow Rate: 40-50 CFH

## DIAMETERS / PACKAGING

Diameter in (mm)	33 lb (15kg) Fiber Spool (Plastic Bag)
0.045 (1.1)	ED035419
0.052 (1.3)	ED035420

## MECHANICAL PROPERTIES<sup>(1)</sup>

	Yield Strength <sup>(2)</sup> MPa (ksi)	Tensile Strength MPa (ksi)	Elongation (%)	Charpy V-Notch J (ft-lbf)	
				-40°C (-40°F)	-51°C (-60°F)
<b>Requirements</b>					
AWS A5.29 E111T1-K3C-JH4 As-Welded with 100% CO <sub>2</sub>	675 (98) min	760-895 (110-130)	15 min	27 (20) min	-
AWS A5.36 E111T1-C1A6-K3-H4 As-Welded with 100% CO <sub>2</sub>	675 (98) min	760-895 (110-130)	15 min	-	27 (20) min
AWS A5.36 E101T1-C1P4-K3-H4 Stress Relieved with 100% CO <sub>2</sub> for 1 hr @ 620°C (1150°F)	605 (88) min	690-825 (100-120)	16 min	27 (20) min	-
<b>Typical Results<sup>(3)</sup></b>					
As-Welded with 100% CO <sub>2</sub>	735-745 (107-108)	780-790 (113-115)	19-20	67-70 (49-52)	62-66 (46-48)
Stress Relieved with 100% CO <sub>2</sub> for 1 hr @ 620°C (1150°F)	680-725 (99-105)	740-780 (107-113)	20-25	67-70 (49-52)	-

<sup>(1)</sup> Typical all weld metal. <sup>(2)</sup> Measure with 0.2% offset. <sup>(3)</sup> See test results disclaimer

**DEPOSIT COMPOSITION<sup>(1)</sup>**

	%C	%Mn	%Si	%S	%P	%Ni
<b>Requirements</b> AWS A5.29 E111T1-K3C-JH4 AWS A5.36 E111T1-C1A6-K3-H4, E101T1-C1P4-K3-H4	0.15 max	0.75-2.25	0.80 max	0.030 max	0.030 max	1.25-2.60
<b>Typical Results<sup>(3)</sup></b> As-Welded with 100% CO <sub>2</sub>	0.05-0.07	1.59-1.73	0.25-0.28	0.007-0.011	0.008-0.011	2.41-2.50
	%Cr	%Mo	%V	%B	Diffusible Hydrogen (mL/100g weld deposit)	
<b>Requirements</b> AWS A5.29 E111T1-K3C-JH4 AWS A5.36 E111T1-C1A6-K3-H4, E101T1-C1P4-K3-H4	0.15 max	0.25-0.65	0.05 max	Not Specified	4.0 max	
<b>Typical Results<sup>(3)</sup></b> As-Welded with 100% CO <sub>2</sub>	0.04-0.12	0.41-0.49	0.00-0.01	0.003-0.004	1-3	

**TYPICAL OPERATING PROCEDURES**

Diameter, Polarity Shielding Gas	CTWD <sup>(4)</sup> mm (in)	Wire Feed Speed m/min (in/min)	Voltage (volts)	Approx. Current (amps)	Melt-Off Rate kg/hr (lb/hr)	Deposition Rate kg/hr (lb/hr)	Efficiency (%)
0.045 in (1.1 mm), DC+	19 (3/4)	4.4 (175)	25 - 29	130	1.9 (4.1)	1.7 (3.7)	89-90
	19 (3/4)	6.4 (250)	27 - 31	170	2.6 (5.8)	2.4 (5.2)	
	19 (3/4)	7.6 (300)	28 - 32	195	3.2 (7.0)	2.8 (6.2)	
	19 (3/4)	8.9 (350)	28 - 32	220	3.7 (8.1)	3.3 (7.2)	
	25 (1)	10.2 (400)	28 - 32	225	4.2 (9.2)	3.7 (8.2)	
	25 (1)	11.4 (450)	29 - 33	245	4.7 (10.4)	4.2 (9.2)	
0.052 in (1.3 mm), DC+	25 (1)	12.7 (500)	30 - 34	265	5.2 (11.5)	4.6 (10.2)	82-84
	19 (3/4)	3.8 (150)	26 - 30	160	2.1 (4.6)	1.7 (3.8)	
	19 (3/4)	4.4 (175)	26 - 30	180	2.4 (5.4)	2.0 (4.5)	
	19 (3/4)	5.1 (200)	27 - 31	200	2.8 (6.2)	2.3 (5.1)	
	19 (3/4)	5.7 (225)	27 - 31	220	3.2 (7.0)	2.6 (5.8)	
	19 (3/4)	7.0 (275)	28 - 32	255	3.9 (8.5)	3.2 (7.1)	
	25 (1)	7.6 (300)	28 - 32	230	4.2 (9.3)	3.5 (7.8)	
	25 (1)	8.3 (325)	28 - 32	245	4.6 (10.1)	3.8 (8.4)	
25 (1)	8.9 (350)	29 - 33	255	4.9 (10.9)	4.1 (9.1)		

<sup>(1)</sup> Typical all weld metal. <sup>(2)</sup> Measure with 0.2% offset. <sup>(3)</sup> See test results disclaimer <sup>(4)</sup> To estimate ESO, subtract 1/4 in (6.0 mm) from CTWD.

# ULTRACORE® 111K3M-H PLUS

Low Alloy, All Positions ▪ AWS E111T1-K3M-JH4, E111T1-M21A6-K3-H4

## KEY FEATURES

- Innovative design capable of superior toughness at -60°F in both the as-welded and stress-relieved conditions
- Designed for welding with 75-80% Argon/ Balance CO<sub>2</sub> shielding gas
- H4 diffusible hydrogen levels
- Q2 Lot® - Certificate showing actual deposit chemistry and mechanical properties per lot available online
- ProTech® foil bag packaging

## WELDING POSITIONS

All

## CONFORMANCES

- AWS A5:** E101T1-M21P4-K3-H4, E111T1-M21A6-K3-H4, E111T1-K3M-JH4
- ABS:** E111T1-K3M-JH4, E111T1-M21A6-K3-H4

## TYPICAL APPLICATIONS

- Offshore drilling rigs
- Low temperature storage tanks
- Ship building
- Construction

## SHIELDING GAS

75-80% Argon / Balance CO<sub>2</sub>  
Flow Rate: 40-50 CFH

## DIAMETERS / PACKAGING

Diameter in (mm)	33 lb (15 kg) Fiber Spool (Plastic Bag)
0.045 (1.1)	ED035417
0.052 (1.3)	ED035418

## MECHANICAL PROPERTIES<sup>(1)</sup>

	Yield Strength <sup>(2)</sup> MPa (ksi)	Tensile Strength MPa (ksi)	Elongation (%)	Charpy V-Notch J (ft·lbf)	
				-40°C (-40°F)	-51°C (-60°F)
<b>Requirements</b>					
AWS A5.29 E111T1-K3M-JH4 As-Welded with 75% Ar / 25% CO <sub>2</sub>	675 (98) min	760-895 (110-130)	15 min	27 (20) min	-
AWS A5.36 E111T1-M21A6-K3-H4 As-Welded with 75% Ar / 25% CO <sub>2</sub>	675 (98) min	760-895 (110-130)	15 min	-	27 (20) min
AWS A5.36 E101T1-M21P4-K3-H4 Stress Relieved with 75% Ar / 25% CO <sub>2</sub> for 1 hr @ 620°C (1150°F)	605 (88) min	690-825 (100-120)	16 min	27 (20) min	-
<b>Typical Results<sup>(3)</sup></b>					
As-Welded with 75% Argon / 25% CO <sub>2</sub>	725-745 (105-108)	770-785 (112-114)	19-20	50-54 (37-40)	47-52 (34-39)
Stress Relieved with 75% Ar / 25% CO <sub>2</sub> for 1 hr @ 620°C (1150°F)	705-720 (102-105)	765-775 (110-112)	21-22	50-54 (37-40)	-

<sup>(1)</sup> Typical all weld metal. <sup>(2)</sup> Measure with 0.2% offset. <sup>(3)</sup> See test results disclaimer

**DEPOSIT COMPOSITION<sup>(1)</sup>**

	%C	%Mn	%Si	%S	%P	%Ni
<b>Requirements</b> AWS A5.29 E111T1-K3M-JH4 AWS A5.36 E111T1-M21A6-K3-H4, E101T1-M21P4-K3-H4	0.15 max	0.75-2.25	0.80 max	0.030 max	0.030 max	1.25-2.60
<b>Typical Results<sup>(3)</sup></b> As-Welded with 75% Argon / 25% CO <sub>2</sub>	0.05-0.06	1.59-1.84	0.27-0.34	0.007	0.010-0.011	2.31-2.60
	%Cr	%Mo	%V	%B	Diffusible Hydrogen (mL/100g weld deposit)	
<b>Requirements</b> AWS A5.29 E111T1-K3M-JH4 AWS A5.36 E111T1-M21A6-K3-H4, E101T1-M21P4-K3-H4	0.15 max	0.25-0.65	0.05 max	Not Specified	4.0 max	
					4 max	
<b>Typical Results<sup>(3)</sup></b> As-Welded with 75% Argon / 25% CO <sub>2</sub>	0.04-0.07	0.45-0.51	0.00	0.004-0.005	1-3	

**TYPICAL OPERATING PROCEDURES**

Diameter, Polarity Shielding Gas	CTWD <sup>(4)</sup> mm (in)	Wire Feed Speed m/min (in/min)	Voltage (volts)	Approx. Current (amps)	Melt-Off Rate kg/hr (lb/hr)	Deposition Rate kg/hr (lb/hr)	Efficiency (%)
0.045 in (1.1 mm), DC+	19 (3/4)	4.4 (175)	24 - 28	120	1.8 (3.9)	1.5 (3.4)	85-87
	19 (3/4)	6.4 (250)	25 - 29	140	2.5 (5.6)	2.2 (4.8)	
	19 (3/4)	7.6 (300)	26 - 30	155	3.1 (6.8)	2.6 (5.8)	
	19 (3/4)	8.9 (350)	27 - 31	170	3.6 (7.9)	3.1 (6.8)	
	25 (1)	10.2 (400)	28 - 32	185	4.1 (9.0)	3.5 (7.8)	
	25 (1)	11.4 (450)	28 - 32	200	4.6 (10.1)	4.0 (8.8)	
	25 (1)	12.7 (500)	29 - 33	220	5.1 (11.3)	4.4 (9.8)	
0.052 in (1.3 mm), DC+	19 (3/4)	3.8 (150)	26 - 29	160	2.1 (4.6)	1.7 (3.8)	82-84
	19 (3/4)	4.4 (175)	26 - 29	180	2.4 (5.4)	2.0 (4.5)	
	19 (3/4)	5.1 (200)	27 - 30	200	2.8 (6.2)	2.3 (5.1)	
	19 (3/4)	5.7 (225)	27 - 30	220	3.2 (7.0)	2.6 (5.8)	
	19 (3/4)	7.0 (275)	28 - 31	255	3.9 (8.5)	3.2 (7.1)	
	25 (1)	7.6 (300)	28 - 31	230	4.2 (9.3)	3.5 (7.8)	
	25 (1)	8.3 (325)	28 - 31	245	4.6 (10.1)	3.8 (8.4)	
	25 (1)	8.9 (350)	29 - 32	255	4.9 (10.9)	4.1 (9.1)	

<sup>(1)</sup> Typical all weld metal. <sup>(2)</sup> Measure with 0.2% offset. <sup>(3)</sup> See test results disclaimer. <sup>(4)</sup> To estimate ESO, subtract 1/4 in (6.0 mm) from CTWD.

# ULTRACORE® 121K3M-H PLUS

Low Alloy, All Positions ▪ AWS E121T1-GM-H4, E121T1-M21A6-K3-H4

## KEY FEATURES

- Innovative design capable of superior toughness at -60°F in both the as-welded and stress-relieved conditions
- Designed for welding with 75-80% Argon/ Balance CO<sub>2</sub> shielding gas
- H4 diffusible hydrogen levels
- Q2 Lot® - Certificate showing actual deposit chemistry and mechanical properties per lot available online
- ProTech® foil bag packaging

## CONFORMANCES

- AWS A5:** E111T1-M21P4-K3-H4, E121T1-M21A6-K3-H4, E121T1-GM-H4
- ABS:** E121T1-GM-H4, E121T1-M21A6-K3-H4

## TYPICAL APPLICATIONS

- Offshore drilling rigs
- Ship building
- Low temperature storage tanks
- Construction

## WELDING POSITIONS

All

## SHIELDING GAS

75-80% Argon / Balance CO<sub>2</sub>  
Flow Rate: 40-50 CFH

## DIAMETERS / PACKAGING

Diameter in (mm)	33 lb (15 kg) Fiber Spool (Plastic Bag)
0.045 (1.1)	ED035423
0.052 (1.3)	ED035424

## MECHANICAL PROPERTIES<sup>(1)</sup>

	Yield Strength <sup>(2)</sup> MPa (ksi)	Tensile Strength MPa (ksi)	Elongation (%)	Charpy V-Notch J (ft-lbf)	
				-40°C (-40°F)	-51°C (-60°F)
<b>Requirements</b>					
AWS A5.29 E121T1-GM-H4 As-Welded with 75% Ar / 25% CO <sub>2</sub>	745 (108) min	825-965 (120-140)	14 min	-	-
AWS A5.36 E121T1-M21A6-K3-H4 As-Welded with 75% Ar / 25% CO <sub>2</sub>	745 (108) min	825-965 (120-140)	14 min	-	27 (20) min
AWS A5.36 E111T1-M21P4-K3-H4 Stress Relieved with 75% Ar / 25% CO <sub>2</sub> for 1 hr @ 620°C (1150°F)	675 (98) min	760-895 (110-130)	15 min	27 (20) min	-
<b>Typical Results<sup>(3)</sup></b>					
As-Welded with 75% Argon / 25% CO <sub>2</sub>	815-840 (118-122)	850-875 (123-127)	17-18	65-67 (48-50)	59-61 (44-45)
Stress Relieved with 75% Ar / 25% CO <sub>2</sub> for 1 hr @ 620°C (1150°F)	745-765 (108-111)	805-820 (116-119)	18-23	65-67 (48-50)	-

<sup>(1)</sup> Typical all weld metal. <sup>(2)</sup> Measure with 0.2% offset. <sup>(3)</sup> See test results disclaimer

**DEPOSIT COMPOSITION<sup>(1)</sup>**

	%C	%Mn	%Si	%S	%P	%Ni
<b>Requirements</b> AWS A5.29 E121T1-GM-H4 AWS A5.36 E121T1-M21A6-K3-H4, E111T1-M21P4-K3-H4	Not Specified	0.50 <sup>(4)</sup>	1.00 max	0.030 max	0.030 max	0.50 <sup>(4)</sup>
	0.15 max	0.75-2.25	0.80 max	0.030 max	0.030 max	1.25-2.60
<b>Typical Results<sup>(3)</sup></b> As-Welded with 75% Argon / 25% CO <sub>2</sub>	0.06-0.07	1.61-1.80	0.26-0.35	0.007-0.012	0.010-0.011	2.21-2.46
	%Cr	%Mo	%V	%B	Diffusible Hydrogen (mL/100g weld deposit)	
<b>Requirements</b> AWS A5.29 E121T1-GM-H4 AWS A5.36 E121T1-M21A6-K3-H4, E111T1-M21P4-K3-H4	0.30 <sup>(4)</sup>	0.20 <sup>(4)</sup>	0.10 <sup>(4)</sup>	Not Specified	4.0 max	
	0.15 max	0.25-0.65	0.05 max		4 max	
<b>Typical Results<sup>(3)</sup></b> As-Welded with 75% Argon / 25% CO <sub>2</sub>	0.04-0.07	0.58- 0.65	0.00	0.004-0.005	1-3	

**TYPICAL OPERATING PROCEDURES**

Diameter, Polarity Shielding Gas	CTWD <sup>(5)</sup> mm (in)	Wire Feed Speed m/min (in/min)	Voltage (volts)	Approx. Current (amps)	Melt-Off Rate kg/hr (lb/hr)	Deposition Rate kg/hr (lb/hr)	Efficiency (%)
0.045 in (1.1 mm), DC+	19 (3/4)	4.4 (175)	24 - 28	120	1.8 (3.9)	1.5 (3.4)	85-87
	19 (3/4)	6.4 (250)	25 - 29	140	2.5 (5.6)	2.2 (4.8)	
	19 (3/4)	7.6 (300)	26 - 30	155	3.1 (6.8)	2.6 (5.8)	
	19 (3/4)	8.9 (350)	27 - 31	170	3.6 (7.9)	3.1 (6.8)	
	25 (1)	10.2 (400)	28 - 32	185	4.1 (9.0)	3.5 (7.8)	
	25 (1)	11.4 (450)	28 - 32	200	4.6 (10.1)	4.0 (8.8)	
	25 (1)	12.7 (500)	29 - 33	220	5.1 (11.3)	4.4 (9.8)	
0.052 in (1.3 mm), DC+	19 (3/4)	3.8 (150)	26 - 29	160	2.1 (4.6)	1.7 (3.8)	82-84
	19 (3/4)	4.4 (175)	26 - 29	180	2.4 (5.4)	2.0 (4.5)	
	19 (3/4)	5.1 (200)	27 - 30	200	2.8 (6.2)	2.3 (5.1)	
	19 (3/4)	5.7 (225)	27 - 30	220	3.2 (7.0)	2.6 (5.8)	
	19 (3/4)	7.0 (275)	28 - 31	255	3.9 (8.5)	3.2 (7.1)	
	25 (1)	7.6 (300)	28 - 31	230	4.2 (9.3)	3.5 (7.8)	
	25 (1)	8.3 (325)	28 - 31	245	4.6 (10.1)	3.8 (8.4)	
25 (1)	8.9 (350)	29 - 32	255	4.9 (10.9)	4.1 (9.1)		

<sup>(1)</sup> Typical all weld metal. <sup>(2)</sup> Measure with 0.2% offset. <sup>(3)</sup> See test results disclaimer

<sup>(4)</sup> In order to meet the requirements of the G group, the undiluted weld metal shall have not less than the minimum specified for one or more of the elements listed.

<sup>(5)</sup> To estimate ESO, subtract 1/4 in (6.0 mm) from CTWD.

# CORMET™ 1

Low Alloy, All Position ▪ AWS E81T1-B2C-H4/M-H4

## KEY FEATURES

- Designed for strength and resistance to corrosion
- Cr-Mo Alloyed steel for elevated temperature service to aid creep resistance

## WELDING POSITIONS

All

## SHIELDING GAS

80% Argon / 20% CO<sub>2</sub>  
 100% CO<sub>2</sub>  
 Flow Rate: 40-50 CFH

## CONFORMANCES

AWS A5.29 E81T1-B2C-H4/M-H4

## TYPICAL APPLICATIONS

- Piping
- Chemical & Petrochemical Industry
- Steam Generating
- Pressure Vessels

## DIAMETERS / PACKAGING

Diameter mm (in)	15 kg (33 lb) Spool
1.2 (0.045)	CORM1-12N

## MECHANICAL PROPERTIES<sup>(1)</sup>

	Yield Strength <sup>(2)</sup> ksi (MPa)	Tensile Strength ksi (MPa)	Elongation %	Charpy V-Notch J (ft-lbf) @20° C (68° F)	Hardness HV
<b>Requirements</b> AWS E81T1-B2C-H4	68 (470) min	80-100 (550-690) min	19 min	-	-
<b>Typical Results<sup>(3)</sup></b> after 1 hour stress relief at 1275° F (691° C)	80 (550)	94 (650)	24	30	220

## DEPOSIT COMPOSITION<sup>(1)</sup>

	%C	%Mn	%Si	%S
<b>Requirements</b> AWS E81T1-B2C-H4	0.05-0.12	1.25 max	0.80 max	0.030 max
<b>Typical Results<sup>(3)</sup></b>	0.06	1.0	0.3	0.01
	%P	%Cr	%Mo	%Cu
<b>Requirements</b> AWS E81T1-B2C-H4	0.030 max	1.00-1.50	0.40-0.65	0.3 max
<b>Typical Results<sup>(3)</sup></b>	0.01	1.3	0.5	0.05

## TYPICAL OPERATING PROCEDURES

Diameter, Polarity mm (in)	Voltage <sup>(4)</sup> (Volts)	Amperage (Amps)	Typical	CTWD mm (in)
1.2 (0.045) DC+	24-30	160-260	190A /25V	15-25 (5/8-1)

<sup>(1)</sup> Typical all weld metal <sup>(2)</sup> Measured with 0.2% offset <sup>(3)</sup> See test results disclaimer <sup>(4)</sup> Settings are for 80%Ar/20%CO<sub>2</sub> shielding gas. Increase voltage 1-2V for 100% CO<sub>2</sub>.

# CORMET™ 2

Low Alloy, All Position ▪ AWS E91T1-B3C/M-H4

## KEY FEATURES

- High metal recovery
- Smooth arc performance in all positions

## WELDING POSITIONS

All

## SHIELDING GAS

80% Argon / 20% CO<sub>2</sub>  
100% CO<sub>2</sub>  
Flow Rate: 40-50 CFH

## CONFORMANCES

AWS A5.29	E91T1-B3C/M-H4
BS EN ISO 17634-B	T62T1-1C/M-2C1M
ASME IX	QW432 F-No 6, QW442 A-No 4

## TYPICAL APPLICATIONS

- Designed for prolonged elevated temperature service up to 600°C (1112°F)
- Refineries where corrosion resistance to sulphur bearing crude oil is at 250-450°C (482-842°F)
- Designed for all-position welding of 2.25% chromium, 1% molybdenum low alloy steels
  - Petro-Chemical
  - Power Plants
  - Piping
  - Turbine Casting
  - Steam Chests
  - Valve Bodies
  - Boiler Superheaters

## DIAMETERS / PACKAGING

Diameter mm (in)	15 kg (33 lb) Spool
1.2 (0.045)	CORM2-12N

## MECHANICAL PROPERTIES<sup>(1)</sup>

	Yield Strength <sup>(2)</sup> ksi (MPa)	Tensile Strength ksi (MPa)	Elongation %	Charpy V-Notch J (ft•lbf) @ 20°C (68°F)	Hardness HV10 <sup>(4)</sup> @ PWHT
<b>Requirements</b> AWS E91T1-B3C/M-H4	78 (540) min	90-110 (620-760) min	17 min	–	–
<b>Typical Results<sup>(3)</sup></b> Stress-Relieved 1 Hour @1275°F (691°C)	91 (625)	105 (725)	22	45	235

## DEPOSIT COMPOSITION<sup>(1)</sup>

	%C	%Mn	%Si	%S
<b>Requirements</b> AWS E91T1-B3C/M-H4	0.05 - 0.12	1.25 max	0.80 max	0.030 max
<b>Typical Results<sup>(3)</sup></b>	0.06	1.0	0.30	0.01
	%P	%Cr	%Mo	%Cu
<b>Requirements</b> AWS E91T1-B3C/M-H4	0.030 max	2.00 - 2.50	0.90 - 1.20	0.30 max
<b>Typical Results<sup>(3)</sup></b> after 1 hour stress relief at 1275°F (691°C)	0.01	2.3	1.0	0.05

## TYPICAL OPERATING PROCEDURES<sup>(5)</sup>

Diameter, Polarity in (mm)	Voltage (Volts)	Amperage (Amps)	Typical	CTWD in (mm)
1.2 (0.045) DC+	24-30	160-260	190A / 25V	15 - 25 (5/8 - 1)

<sup>(1)</sup>Typical all weld metal. <sup>(2)</sup>Measured with 0.2% offset. <sup>(3)</sup>See test results disclaimer <sup>(4)</sup>Industry specific data, not required by AWS. <sup>(5)</sup>Settings are for 80%Ar/20%CO<sub>2</sub> shielding gas. Increase voltage 1-2V for 100% CO<sub>2</sub>.  
NOTE: Additional test data available upon request.



# CORMET™ 5

Low Alloy, All Position ▪ AWS E81T1-B6C/M

## KEY FEATURES

- Designed for high strength and improved corrosion resistance with hot hydrogen gas, super-heated steam, and Sulphur crude oils
- Smooth arc performance in all positions

## WELDING POSITIONS

All

## SHIELDING GAS

80% Argon / 20% CO  
Flow Rate: 40-50 CFH

## CONFORMANCES

AWS 5.29 E81T1-B6C/M

## TYPICAL APPLICATIONS

- Piping
- Steam Generating Power Plant
- Pressure Vessels
- Oil Refineries

## DIAMETERS / PACKAGING

Diameter mm (in)	15 kg (33.1 lb) Spool
1.2 (0.045)	CM5-12

## MECHANICAL PROPERTIES<sup>(1)</sup>

	Yield Strength <sup>(2)</sup> MPa (ksi)	Tensile Strength MPa (ksi)	Elongation %
<b>Requirements</b> AWS E81T1-B6C/M	470 (68)min	550 (80) min	19 min
<b>Typical Results<sup>(3)</sup></b> As-Welded	600 (87)	690 (100)	22

## DEPOSIT COMPOSITION<sup>(1)</sup>

	%C	%Mn	%Si	%S	%P
<b>Requirements</b> AWS E81T1-B6C/M	0.05-0.10	1.20 max	0.50 max	0.030 max	0.030 max
<b>Typical Results<sup>(3)</sup></b>	0.06	0.8	0.3	0.01	0.01
	%Cr	%Ni	%Mo	%Cu	
<b>Requirements</b> AWS E81T1-B6C/M	4.0-6.0	0.40 max	0.45-0.65	0.3 max	
<b>Typical Results<sup>(3)</sup></b>	5	0.01	0.5	0.05	

## TYPICAL OPERATING PROCEDURES

Diameter mm (in)	Polarity	Amp-Volt Range	Typical	Stickout mm (in)
1.2 (0.045)	DC+	160-260A / 24-30V	25V	15-25 (5/8-1)

<sup>(1)</sup> Typical all weld metal <sup>(2)</sup> Measured with 0.2% offset <sup>(3)</sup> See test results disclaimer <sup>(4)</sup> Preferred polarity is listed first.

# SUPERCORE® F91

Low Alloy, All Position ▪ AWS E91T1-B9C/M-H4

## KEY FEATURES

- High deposition rates
- Fast freezing slag for out of position welding
- Designed to weld the modified steels T91, P91 or Grade 91. Which are designed to provide improved creep strength
- Meets current EPRI recommendation of %Ni + %Mn < 1.0%

## SHIELDING GAS

100% CO<sub>2</sub>  
75% Argon / 25% CO<sub>2</sub>  
Flow Rate: 40-50 CFH

## CONFORMANCES

<b>AWS A5.29M</b>	E91T1-B9C/M-H4
<b>AWS A5.36M</b>	(Dependent on shielding gas) E91T1-C1PZ-B91-H4 or E91T1-M21PZ-B91-H4
<b>EN ISO 17634-B</b>	T69T1-1C/M-9C1MV

## TYPICAL APPLICATIONS

- Power Plants
- Turbine Castings
- Piping
- Oil Refineries

## WELDING POSITIONS

All

## DIAMETERS / PACKAGING

Diameter mm (in)	15 kg (33 lb) Spool
1.2 (0.045)	ED033387, SCF91-12*

\*The Metrode part number will be replacing the current EDO numbers after the inventory has been depleted.

## MECHANICAL PROPERTIES<sup>(1)</sup>

	Yield Strength <sup>(2)</sup> MPa (ksi)	Tensile Strength MPa (ksi)	Elongation %	Charpy V-Notch J (ft·lbf) @ 20 °C (68 °F)	PWHT
<b>Requirements</b> AWS E91T1-B9C/M-H4	565 (82) min	690 (100) min	16 min	–	–
<b>Typical Results<sup>(3)</sup></b> Room Temperature 2 hr @760°C (1400°F) 6 hr @ 760°C (1400°F) High Temperature +566°C (1050°F) +600°C (1112°F) +650°C (1202°F)	660 (96) 630 (91) 360 (52) 288 (42) 245 (36)	790 (115) 750 (109) 450 (65) 420 (61) 396 (57)	20 23 21 27 29	28 (82) 36 (97) – – –	260 – – – –

## DEPOSIT COMPOSITION<sup>(1)</sup>

	%C	%Mn	%Si	%S	%P	%Cr	%Ni
<b>Requirements</b> AWS E91T1-B9C/M-H4	0.08 - 0.13	0.60 - 1.20	0.50 max	0.015 max	0.020 max	8.0 - 10.0	0.80 max
<b>Typical Results<sup>(3)</sup></b>	0.10	0.80	0.30	0.01	0.016	9.0	0.50
	%Mo	%Nb	%V	%N	%Cu	%Al	%Ni+Mn
<b>Requirements</b> AWS E91T1-B9C/M-H4	0.85 - 1.2	0.02 - 0.07	0.15 - 0.25	0.02 - 0.07	0.15 max	0.40 max	1.5 max
<b>Typical Results<sup>(3)</sup></b>	1.0	0.04	0.20	0.05	0.05	0.01	1.30

## TYPICAL OPERATING PROCEDURES

Diameter in (mm)	Amp-Volt Range	Typical	Stickout in (mm)
1.2 (0.045) DC+	140 - 170A 24 - 26V	160A, 25V	15 - 25 (5/8 - 1)

<sup>(1)</sup>Typical all weld metal. <sup>(2)</sup>Measured with 0.2% offset. <sup>(3)</sup>See test results disclaimer <sup>(4)</sup>Industry specific data, not required by AWS.  
NOTE: Additional test data available upon request.

# ULTRACORE® 80Ni1C

Low Alloy, Flat & Horizontal ▪ AWS E80T1-Ni1C-JH8, E80T1-C1A4-Ni1-H8

## KEY FEATURES

- High deposition in the flat and horizontal positions
- Excellent operator appeal and slag detachability
- Designed for welding with 100% CO<sub>2</sub> shielding gas
- ProTech® foil bag packaging

## WELDING POSITIONS

Flat & Horizontal

## SHIELDING GAS

100% CO<sub>2</sub>  
Flow Rate: 40-55 CFH

## CONFORMANCES

- AWS A5:** E80T1-M21A4-Ni1-H8, E80T1-Ni1M-JH8  
**CWB/CSA:** E550T1-C1A4-Ni1-H8, E80T1-C1A4-Ni1-H8  
**AWS D1.8:** 1/16", 5/64", 3/32"

## TYPICAL APPLICATIONS

- Structural fabrication
- Heavy equipment
- Shipbuilding

## DIAMETERS / PACKAGING

Diameter in (mm)	50 lb (22.7 kg) Coil	500 lb (227 kg) Accu-Trak® Drum	500 lb (227 kg) Speed-Feed® Drum
5/64 (2.0)	ED035766		ED036640
3/32 (2.4)	ED035767		ED036639

## MECHANICAL PROPERTIES<sup>(1)</sup>

	Yield Strength <sup>(2)</sup> MPa (ksi)	Tensile Strength MPa (ksi)	Elongation %	Charpy V-Notch J (ft-lbf) -40°C (-40°F)
<b>Requirements<sup>(4)</sup></b> AWS A5.29 E80T1-Ni1C-JH8	470 (68) min	550-690 (80-100)	19 min	27 (20) min
<b>Requirements<sup>(4)</sup></b> AWS A5.36 E80T1-C1A4-Ni1-H8	470 (68) min	550-690 (80-100)	19 min	27 (20) min
<b>Typical Results<sup>(3)</sup></b> As-Welded with 100% CO <sub>2</sub>	500-600 (80-87)	630-670 (91-97)	24-28	43-72 (32-53)

<sup>(1)</sup>Typical all weld metal. <sup>(2)</sup>Measured with 0.2% offset. <sup>(3)</sup>See test results disclaimer <sup>(4)</sup>As-Welded with 100% CO<sub>2</sub> <sup>(5)</sup>To estimate ESO, subtract 1/4 in (6.0 mm) from CTWD.

**DEPOSIT COMPOSITION<sup>(1)</sup>**

	%C	%Mn	%Si	%S	%P	%Ni
<b>Requirements</b>						
AWS A5.29 E80T1-Ni1C-JH8	0.12 max	1.50 max	0.80 max	0.03 max	0.03 max	0.80-1.10
AWS A5.36 E80T1-C1A4-Ni1-H8	0.12 max	1.75 max	0.80 max	0.030 max	0.030 max	0.80-1.10
<b>Typical Results<sup>(3)</sup></b>						
As-Welded with 100% CO <sub>2</sub>	0.04-0.07	1.32-1.45	0.52-0.59	0.006-0.008	0.013-0.016	0.81-1.03
	%Cr	%Mo	%V	%B	Diffusible Hydrogen (mL/100g weld deposit)	
<b>Requirements</b>						
AWS A5.29 E80T1-Ni1C-JH8	0.15 max	0.35 max	0.05 max	Not Specified	8.0 max	
AWS A5.36 E80T1-C1A4-Ni1-H8	0.15 max	0.35 max	0.05 max		8 max	
<b>Typical Results<sup>(3)</sup></b>						
As-Welded with 100% CO <sub>2</sub>	0.04-0.09	0.01	0.02-0.03	0.003-0.005	3.4-5.6	

**TYPICAL OPERATING PROCEDURES – Flat & Horizontal**

Diameter, Polarity Shielding Gas	CTWD <sup>(5)</sup> mm (in)	Wire Feed Speed m/min (in/min)	Voltage (volts)	Approx. Current (amps)	Melt-Off Rate kg/hr (lb/hr)	Deposition Rate kg/hr (lb/hr)	Efficiency (%)
1/16 in (1.6 mm), DC+ 100% CO <sub>2</sub>	25 (1)	3.2 (125)	23-27	155	2.2 (4.8)	2.0 (4.4)	84 - 89
		6.4 (250)	25-29	250	4.5 (9.9)	4.0 (8.8)	
		9.5 (375)	28-32	325	6.8 (14.9)	6.0 (13.2)	
5/64 in (2.0 mm), DC+ 100% CO <sub>2</sub>	25 (1)	3.2 (125)	23-27	240	3.5 (7.8)	3.1 (6.8)	84 - 88
		5.7 (225)	25-29	350	6.4 (14.0)	5.5 (12.2)	
3/32 in (2.4 mm), DC+ 100% CO <sub>2</sub>	31 (1 1/4)	8.3 (325)	27-32	395	8.5 (18.6)	7.5 (16.4)	87 - 89
		3.2 (125)	27-32	320	5.4 (11.9)	4.7 (10.3)	
		5.1 (200)	28-33	450	8.6 (19.0)	7.6 (16.7)	
		6.4 (250)	31-37	580	13.1 (28.8)	11.4 (25.1)	

<sup>(1)</sup>Typical all weld metal. <sup>(2)</sup>Measured with 0.2% offset. <sup>(3)</sup>See test results disclaimer. <sup>(4)</sup>As-Welded with 100% CO<sub>2</sub>. <sup>(5)</sup>To estimate ESO, subtract 1/4 in (6.0 mm) from CTWD.

# ULTRACORE® 80Ni1M

Low Alloy, Flat & Horizontal ▪ AWS E80T1-Ni1M-JH8, E80T1-M21A4-Ni1-H8

## KEY FEATURES

- High deposition in the flat and horizontal positions
- Excellent operator appeal and slag detachability
- Designed for welding with 75-80% Argon / balance CO<sub>2</sub> shielding gas
- ProTech® foil bag packaging

## WELDING POSITIONS

Flat & Horizontal

## SHIELDING GAS

75-80% Argon / balance CO<sub>2</sub>  
Flow Rate: 40-55 CFH

## CONFORMANCES

**AWS A5:** E80T1-M21A4-Ni1-H8, E80T1-Ni1M-JH8

## TYPICAL APPLICATIONS

- Structural fabrication
- Heavy equipment
- Shipbuilding

## DIAMETERS / PACKAGING

Diameter in (mm)	50 lb (22.7 kg) Coil	500 lb (227 kg) Speed-Feed® Drum
3/32 (2.4)	ED035770	ED036620

## MECHANICAL PROPERTIES<sup>(1)</sup>

	Yield Strength <sup>(2)</sup> MPa (ksi)	Tensile Strength MPa (ksi)	Elongation %	Charpy V-Notch J (ft·lbf) -40°C (-40°F)
<b>Requirements<sup>(4)</sup></b> AWS A5.29 E80T1-Ni1M-JH8	470 (68) min	550-690 (80-100)	19 min	27 (20) min
<b>Requirements<sup>(4)</sup></b> AWS A5.36 E80T1-M21A4-Ni1-H8	470 (68) min	550-690 (80-100)	19 min	27 (20) min
<b>Typical Results<sup>(3)</sup></b> As-Welded with 75% Ar / 25% CO <sub>2</sub>	585-595 (85-86)	630-650 (91-94)	27	50-75 (37-57)

<sup>(1)</sup>Typical all weld metal. <sup>(2)</sup>Measured with 0.2% offset. <sup>(3)</sup>See test results disclaimer. <sup>(4)</sup>As-Welded with 100% CO<sub>2</sub>. <sup>(5)</sup>To estimate ESO, subtract 1/4 in (6.0 mm) from CTWD.

**DEPOSIT COMPOSITION<sup>(1)</sup>**

	%C	%Mn	%Si	%S	%P	%Ni
<b>Requirements</b>						
AWS A5.29 E80T1-Ni1M-JH8	0.12 max	1.50 max	0.80 max	0.03 max	0.03 max	0.80-1.10
AWS A5.36 E80T1-M21A4-Ni1-H8	0.12 max	1.75 max	0.80 max	0.030 max	0.030 max	0.80-1.10
<b>Typical Results<sup>(3)</sup></b>						
As-Welded with 100% CO <sub>2</sub>	0.04-0.06	1.32-1.36	0.54-0.55	0.004-0.006	0.011-0.012	0.91-1.04
	%Cr	%Mo	%V	%B	Diffusible Hydrogen (mL/100g weld deposit)	
<b>Requirements</b>						
AWS A5.29 E80T1-Ni1M-JH8	0.15 max	0.35 max	05 max	Not Specified	8.0 max	
AWS A5.36 E80T1-M21A4-Ni1-H8	0.15 max	0.35 max	0.05 max		8 max	
<b>Typical Results<sup>(3)</sup></b>						
As-Welded with 100% CO <sub>2</sub>	0.04-0.06	0.01	0.02	0.004-0.005	2.9-4.6	

**TYPICAL OPERATING PROCEDURES – Flat & Horizontal**

Diameter, Polarity Shielding Gas	CTWD <sup>(5)</sup> mm (in)	Wire Feed Speed m/min (in/min)	Voltage (volts)	Approx. Current (amps)	Melt-Off Rate kg/hr (lb/hr)	Deposition Rate kg/hr (lb/hr)	Efficiency (%)
3/32 in (2.4 mm), DC+ 75% Ar / 25% CO <sub>2</sub>	25 (1)	3.2 (125)	27-32	340	5.4 (11.9)	4.7 (10.3)	87 - 89
	31 (1 1/4)	5.1 (200) 6.4 (250)	27-32 30-36	465 620	8.6 (19.0) 13.1 (28.8)	7.6 (16.7) 11.4 (25.1)	

<sup>(1)</sup>Typical all weld metal. <sup>(2)</sup>Measured with 0.2% offset. <sup>(3)</sup>See test results disclaimer. <sup>(4)</sup>As-Welded with 100% CO<sub>2</sub>. <sup>(5)</sup>To estimate ESO, subtract 1/4 in (6.0 mm) from CTWD.



# SUBMERGED ARC

## Flux

### 700 Series Active Flux

Lincolnweld® 760® .....	E-1
Lincolnweld® 761® .....	E-2
Lincolnweld® 780® .....	E-3
Lincolnweld® 781™ .....	E-4

### 800 Series Neutral Flux

Lincolnweld® 822™ .....	E-5
Lincolnweld® 842-H™ .....	E-6
Lincolnweld® 860® .....	E-7
Lincolnweld® 865™ .....	E-8
Lincolnweld® 880™ .....	E-9
Lincolnweld® 880M® .....	E-10
Lincolnweld® 882™ .....	E-11
Lincolnweld® 888™ .....	E-12
Lincolnweld® 8500™ .....	E-13
Lincolnweld® MIL800-H™ .....	E-14
Lincolnweld® 812-SRC™ .....	E-15

## Special Neutral Flux

Lincolnweld® 960® .....	E-16
Lincolnweld® 980™ .....	E-17
Lincolnweld® WTX™ .....	E-18
Lincolnweld® WTX™-TR .....	E-19
LA490 .....	E-20

### Flux for Seam Welding of Pipe

Lincolnweld® 761-Pipe™ .....	E-21
Lincolnweld® P223™ .....	E-22
Lincolnweld® LPX80N™ .....	E-23
Lincolnweld® SPX80™ .....	E-24
Lincolnweld® SPX80N™ .....	E-25
Lincolnweld® 995N™ .....	E-26

### High Performance/Alloy Flux

Lincolnweld® A-XXX10™ .....	E-27
Lincolnweld® MIL800-HPNi™ .....	E-28

## Solid Wire

### Mild Steel Solid Electrode

Lincolnweld® L-50® .....	E-29
Lincolnweld® L-56® .....	E-30
Lincolnweld® L-60 .....	E-31
Lincolnweld® L-61® .....	E-32
Lincolnweld® L-S3 .....	E-33
Lincolnweld® LA-71 .....	E-33

### Low Alloy Solid Electrode

Lincolnweld® AK-10™ .....	E-34
Lincolnweld® L-70 .....	E-35
Lincolnweld® LA-75 .....	E-35
Lincolnweld® LA-81 .....	E-36
Lincolnweld® LA-84 .....	E-37
Lincolnweld® LA-85 .....	E-38
Lincolnweld® LA-90 .....	E-39
Lincolnweld® LA-92 .....	E-40
Lincolnweld® LA-93 .....	E-41
Lincolnweld® LA-100 .....	E-42
Techalloy® 4130 .....	E-43

## Cored Wire

### Mild Steel

Lincolnweld® LC-72 .....	E-44
--------------------------	------

### Low Alloy

Lincolnweld® LAC-B2 .....	E-45
Lincolnweld® LAC-Ni2 .....	E-45
Lincolnweld® LAC-690 .....	E-46
9CrMoV-N .....	E-47

## Non-Copper Coated Submerged Arc (SAW) Electrode

### Mild Steel Solid Electrode

Lincolnweld® Emergence® 61 .....	E-48
Lincolnweld® Emergence® 73 .....	E-49

### Low Alloy Solid Electrode

Lincolnweld® Emergence® 70 .....	E-50
Lincolnweld® Emergence® 81 .....	E-51
Lincolnweld® Emergence® 90 .....	E-52



# LINCOLNWELD® 760®

700 Series Active Flux ▪ EN ISO 14174 – S A MS 1; EN ISO 14174 – S A CS 1

## KEY FEATURES

- Highly active flux for handling rust and mill scale
- Helps resist porosity caused by arc blow
- Slow freezing slag for good weld appearance
- Actual (Type 3.1) certificates for each lot of flux showing chemical composition, particle size and moisture level are available in the certificate center of [lincolnelectric.com](http://lincolnelectric.com)

## PACKAGING

50 lb (22.7 kg) Plastic Bag

ED032799

## TYPICAL APPLICATIONS

- Single pass welding of mild steel
- Flat fillet welds with constant voltage power source

## RECOMMENDED WIRES

Mild Steel

Lincolnweld® L-50®, L-60, and L-61®

## PRODUCT INFORMATION

Basicity Index: 0.8

Density: 1.2 g/cm<sup>3</sup>

## FLUX COMPOSITION<sup>(1)</sup>

	%SiO <sub>2</sub>	%MnO	%MgO	%CaF <sub>2</sub>	%Na <sub>2</sub> O	%Al <sub>2</sub> O <sub>3</sub>	%CaO	% Metal Alloys
Lincolnweld® 760®	47	33	17	5	2	2	1	6 max

## AWS TEST RESULTS<sup>(1)</sup>

Flux/Wire Combination	Weld Condition	Yield Strength <sup>(2)</sup> MPa (ksi)	Tensile Strength MPa (ksi)	Elongation (%)	Charpy V-Notch		AWS Classification (A5.17/A5.23)
					J (ft•lbf)	@ °C (°F)	
L-50®	As-welded	440 (64)	550 (80)	30	53 (39)	-18 (0)	F7A0-EM13K
L-60	As-welded	390 (57)	490 (71)	30	98 (72)	-29 (-20)	F6A2-EL12
L-61®	As-welded	410 (59)	530 (77)	28	69 (51)	-29 (-20)	F7A2-EM12K

<sup>(1)</sup>See test results disclaimer <sup>(2)</sup>Measured with 0.2% offset. NOTE: For the most up-to-date AWS certificates of conformance please visit [www.lincolnelectric.com](http://www.lincolnelectric.com)

# LINCOLNWELD® 761®

700 Series Active Flux ▪ EN ISO 14174 – S A MS 1; EN ISO 14174 – S A CS 1

## KEY FEATURES

- Manganese alloying and carbon reducing flux designed to provide superior crack resistance
- Slow freezing slag for a wide, flat weld
- Excellent resistance to cracking in single pass applications
- Actual (Type 3.1) certificates for each lot of flux showing chemical composition, particle size and moisture level are available in the certificate center of lincolnelectric.com

## PACKAGING

50 lb (22.7 kg) Plastic Bag

ED032765

## TYPICAL APPLICATIONS

- Single pass welding of mild steel
- Large fillets with constant current power sources

## RECOMMENDED WIRES

Mild Steel  
Lincolnweld® L-50®, L-60, and L-61®  
Low Alloy Steel  
Lincolnweld® L-70

## PRODUCT INFORMATION

Basicity Index: 0.8  
Density: 1.2 g/cm<sup>3</sup>

## FLUX COMPOSITION<sup>(1)</sup>

	%SiO <sub>2</sub>	%MnO	%MgO	%CaF <sub>2</sub>	%Na <sub>2</sub> O	%Al <sub>2</sub> O <sub>3</sub>	%TiO <sub>2</sub>	%FeO	% Metal Alloys
Lincolnweld® 761®	45	19	22	5	2	2	2	1	6 max

## AWS TEST RESULTS<sup>(1)</sup>

Flux/Wire Combination	Weld Condition	Yield Strength <sup>(2)</sup> MPa (ksi)	Tensile Strength MPa (ksi)	Elongation (%)	Charpy V-Notch		AWS Classification (A5.17/A5.23)
					J (ft•lbf)	@ °C (°F)	
L-50®	As-welded	480 (69)	590 (85)	29	45 (33)	-29 (-20)	F7A2-EM13K-H8
L-60	As-welded	440 (64)	530 (75)	29	64 (47)	-29 (-20)	F7A2-EL12
L-61®	As-welded	480 (70)	590 (85)	28	54 (40)	-29 (-20)	F7A2-EM12K-H8
L-70	As-welded	550 (80)	640 (93)	24	58 (43)	-18 (0)	F9A0-EA1-G

<sup>(1)</sup>See test results disclaimer <sup>(2)</sup>Measured with 0.2% offset. NOTE: For the most up-to-date AWS certificates of conformance please visit [www.lincolnelectric.com](http://www.lincolnelectric.com)

# LINCOLNWELD® 780®

700 Series Active Flux ▪ EN ISO 14174 – S A AB 1; EN ISO 14174 – S A AR 1

## KEY FEATURES

- Industry standard for submerged arc welding applications
- Fast freezing slag for easy removal and minimized spilling on circumferential welds
- When paired with Lincolnweld® L-61® it is recommended for up to three pass welding applications
- Excellent bead shape and slag removal
- Good resistance to moisture contamination for reduced porosity
- Actual (Type 3.1) certificates for each lot of flux showing chemical composition, particle size and moisture level are available in the certificate center of lincolnelectric.com

## PACKAGING

50 lb (22.7 kg) Bag	ED019586
550 lb (249.5 kg) Steel Drum	ED032007
3000 lb (1361 kg) Foil Lined Bulk Bag	ED033188

## TYPICAL APPLICATIONS

- Single pass welding of mild steel
- Roundabouts with minimal spillage
- Horizontal position welding

## RECOMMENDED WIRES

Mild Steel  
Lincolnweld® L-50®, L-60 and L-61®

## PRODUCT INFORMATION

Basicity Index: 0.7  
Density: 1.4 g/cm<sup>3</sup>

## FLUX COMPOSITION<sup>(1)</sup>

	%SiO <sub>2</sub>	%MnO	%MgO	%CaF <sub>2</sub>	%Na <sub>2</sub> O	%Al <sub>2</sub> O <sub>3</sub>	%CaO	%TiO <sub>2</sub>	% Metal Alloys
Lincolnweld® 780®	9	16	2	11	2	45	1	9	6 max

## AWS TEST RESULTS<sup>(1)</sup>

Flux/Wire Combination	Weld Condition	Yield Strength <sup>(2)</sup> MPa (ksi)	Tensile Strength MPa (ksi)	Elongation (%)	Charpy V-Notch		AWS Classification (A5.17/A5.23)
					J (ft•lbf)	@ °C (°F)	
L-50®	As-welded	520 (75)	600 (87)	27	65 (48)	-18 (0)	F7A0-EM13K
L-60	As-welded	440 (64)	520 (76)	30	88 (65)	-18 (0)	F7A0-EL12-H8
L-61®	As-welded	530 (77)	600 (87)	27	46 (34)	-29 (-20)	F7A2-EM12K-H8

<sup>(1)</sup>See test results disclaimer <sup>(2)</sup>Measured with 0.2% offset. NOTE: For the most up-to-date AWS certificates of conformance please visit [www.lincolnelectric.com](http://www.lincolnelectric.com)

# LINCOLNWELD® 781™

700 Series Active Flux ▪ EN ISO 14174 – S A ZS 1

## KEY FEATURES

- Features fast follow characteristics that allow for uniform welds at high speeds without undercut or voids
- Recommended for high speed, limited pass welding on clean plate and sheet steel
- Good wetting action
- Actual (Type 3.1) certificates for each lot of flux showing chemical composition, particle size and moisture level are available in the certificate center of lincolnelectric.com

## PACKAGING

50 lb (22.7 kg) Bag

ED019587

## TYPICAL APPLICATIONS

- Single pass welding – on clean plate and sheet metal up to 4.8 mm (3/16 in) in thickness
- Hot water tanks, metal buildings and other applications requiring high speed welds

## RECOMMENDED WIRES

Mild Steel  
Lincolnweld® L-50®, L-60, and L-61®  
Low Alloy Steel  
Lincolnweld® L-70

## PRODUCT INFORMATION

Basicity Index: 0.8  
Density: 1.5 g/cm<sup>3</sup>

## FLUX COMPOSITION<sup>(1)</sup>

	%SiO <sub>2</sub>	%MnO	%MgO	%CaF <sub>2</sub>	%Na <sub>2</sub> O	%Al <sub>2</sub> O <sub>3</sub>	%ZrO <sub>2</sub>	%TiO <sub>2</sub>	%CaO	% Metal Alloys
Lincolnweld® 781®	21	17	14	5	2	4	21	12	1	3 max

## AWS TEST RESULTS<sup>(1)</sup>

Flux/Wire Combination	Weld Condition	Yield Strength <sup>(2)</sup> MPa (ksi)	Tensile Strength MPa (ksi)	Elongation (%)	Charpy V-Notch		AWS Classification (A5.17/A5.23)
					J (ft•lbf)	@ °C (°F)	
L-50®	As-welded	530 (77)	610 (89)	29	38 (28)	-18 (0)	F7A0-EM13K
L-60	As-welded	460 (67)	550 (80)	29	42 (31)	-18 (0)	F7A0-EL12
L-61®	As-welded	530 (77)	610 (89)	28	31 (23)	-18 (0)	F7A0-EM12K
L-70	As-welded	590 (85)	660 (96)	25	35 (26)	-18 (0)	F9A0-EA1-G

<sup>(1)</sup>See test results disclaimer <sup>(2)</sup>Measured with 0.2% offset. NOTE: For the most up-to-date AWS certificates of conformance please visit [www.lincolnelectric.com](http://www.lincolnelectric.com)

# LINCOLNWELD® 822™

800 Series Neutral Flux ▪ EN ISO 14174 – S A FB 1

## KEY FEATURES

- Designed for chrome-moly applications with Lincolnweld® LA-92 and LA-93 submerged arc wires
- Enables high Charpy V-Notch toughness at temperatures below -40°C (-40°F)
- Step-cooling tests show high resistance to temper embrittlement when welded with Lincolnweld LA-92 and LA-93
- Low Bruscato factor ( $X < 10$ ) when welded with Lincolnweld LA-92 and LA-93
- Certificate of Conformance available with LA-71 to create end user convenience with one flux
- Actual (Type 3.1) certificates for each lot of flux showing chemical composition, particle size and moisture level are available in the certificate center of lincolnelectric.com

## PACKAGING

50 lb (22.7 kg) Plastic Bag ED036223

## TYPICAL APPLICATIONS

- Power Generation
- Process Chemical
- Pressure Vessels

## RECOMMENDED WIRES

Mild Steel  
Lincolnweld® LA-71™  
Low Alloy Steel  
Lincolnweld® LA-92, LA-93

## PRODUCT INFORMATION

Basicity Index: 2.6  
Density: 1.3

## FLUX COMPOSITION<sup>(1)</sup>

	% SiO <sub>2</sub>	% MnO	% MgO	% CaF <sub>2</sub>	% Na <sub>2</sub> O	% Al <sub>2</sub> O <sub>3</sub>	% CaO	% Metal Alloys
Lincolnweld® 822™	15	2	32	21	3	18	5	3 max

## AWS TEST RESULTS<sup>(1)</sup>

Flux/Wire Combination	Weld Condition	Yield Strength <sup>(2)</sup> MPa (ksi)	Tensile Strength MPa (ksi)	Elongation (%)	Charpy V-Notch		AWS Classification (A5.17/A5.23)
					J (ft•lbf)	@ °C (°F)	
LA-92	As-welded	640 (92)	710 (102)	24	95 (70)	-29 (-20)	F9A2-EB2R-B2R-H4
LA-92	Stress-relieved <sup>(3)</sup>	480 (70)	580 (85)	29	200 (148)	-40 (-40)	F8P4-EB2R-B2R-H4
LA-93	As-welded	760 (110)	880 (128)	20	35 (26)	-18 (0)	F11A0-EB3R-B3R-H4
LA-93	Stress-relieved <sup>(3)</sup>	550 (80)	660 (96)	23	156 (115)	-40 (-40)	F9P4-EB3R-B3R-H4
LA-71	As-welded	480 (70)	580 (85)	27	151 (111)	-62 (-80)	F7A8-EM14K-H4
LA-71	Stress-relieved <sup>(4)</sup>	430 (63)	560 (81)	31	127 (93)	-62 (-80)	F7P8-EM14K-H4

<sup>(1)</sup>See test results disclaimer. <sup>(2)</sup>Measured with 0.2% offset. <sup>(3)</sup>Stress-relieved for 1 hour at 691°C (1275°F). <sup>(4)</sup>Stress-relieved for 1 hour at 620°C (1150°F).

# LINCOLNWELD® 842-H™

800 Series Neutral Flux ▪ EN ISO 14174 – S A FB 1 55 AC H4

## KEY FEATURES

- Less than 3 mL of diffusible hydrogen per 100 g of deposited weld metal in DC+ or AC polarity
- Excellent resistance to moisture pick-up
- Consistent and low temperature impact and CTOD toughness
- Capable of welding on multiple arcs
- Excellent slag detachment and bead profiles
- Superior flux particle strength for use in central recovery system
- Actual (Type 3.1) certificates for each lot of flux showing chemical composition, particle size and moisture level are available in the certificate center of lincolnelectric.com

## PACKAGING

50 lb (22.7 kg) Hermetically Sealed Pail ED034371

## TYPICAL APPLICATIONS

- Semi-submersible production and exploration platforms
- Fixed, jacket and work platforms
- Compliant towers
- Topside structural applications
- SPAR, FPSO, and FSO applications
- Jack up rigs

## RECOMMENDED WIRES

Mild Steel Electrode  
Lincolnweld® L-53  
Low Alloy Electrodes  
Lincolnweld® LA-85, LA-84, LAC-690

## PRODUCT INFORMATION

Basicity Index: 2.3  
Density: 1.1 g/cm<sup>3</sup>

## FLUX COMPOSITION<sup>(1)</sup>

	%SiO <sub>2</sub>	%MnO	%MgO	%CaF <sub>2</sub>	%Na <sub>2</sub> O	%Al <sub>2</sub> O <sub>3</sub>	%CaO	% Metal Alloys
Lincolnweld® 842-H™	15	2	32	21	2	21	4	1 max

## AWS TEST RESULTS<sup>(1)</sup>

Flux/Wire Combination	Weld Condition	Yield Strength <sup>(2)</sup> MPa (ksi)	Tensile Strength MPa (ksi)	Elongation (%)	Charpy V-Notch		AWS Classification (A5.17/A5.23)
					J (ft•lbf)	@ °C (°F)	
L-61	As-Welded	440 (64)	520 (76)	33	318 (234)	-51 (-60)	F7A6-EM12K-H4
	Stress Relieved <sup>(3)</sup>	370 (53)	480 (70)	38	335 (247)	-62 (-80)	F6P8-EM12K-H4
L-53	As-Welded	490 (72)	580 (84)	30	187 (138)	-62 (-80)	F7A8-EH12K-H4
	Stress Relieved <sup>(3)</sup>	420 (61)	550 (79)	32	161 (119)	-62 (-80)	F7P8-EH12K-H4
LA-85	As-Welded	540 (78)	610 (89)	28	171 (126)	-62 (-80)	F8A8-ENi5-Ni5-H4
	Stress Relieved <sup>(3)</sup>	510 (74)	600 (87)	30	149 (110)	-62 (-80)	F8P8-ENi5-Ni5-H4
LA-84	As-Welded	640 (93)	720 (104)	25	140 (103)	-62 (-80)	F9A8-EF3-F3-H4
	Stress Relieved <sup>(3)</sup>	610 (89)	700 (101)	28	83 (61)	-62 (-80)	F9P8-EF3-F3-H4

<sup>(1)</sup> See test results disclaimer <sup>(2)</sup> Measured with 0.2% offset. <sup>(3)</sup> Stress-relieved for 1 hour at 621 °C (1150 °F)  
NOTE: For the most up-to-date AWS certificates of conformance please visit [www.lincolnelectric.com](http://www.lincolnelectric.com)

# LINCOLNWELD® 860®

800 Series Neutral Flux ■ EN ISO 14174 – S A AB 1

## KEY FEATURES

- Industry standard for submerged arc welding applications
- Excellent operating characteristics in a variety of general welding applications
- Capable of producing weld deposits with impact toughness exceeding 27 J (20 ft·lbf) at -40°C (-40°F) with Lincolnweld® L-61®
- Actual (Type 3.1) certificates for each lot of flux showing chemical composition, particle size and moisture level are available in the certificate center of lincolnelectric.com

## PACKAGING

50 lb (22.7 kg) Bag

ED019589, ED030840\*

\*Tested Material

## TYPICAL APPLICATIONS

- AASHTO Fracture Critical applications with Lincolnweld® L-61® wire
- Pipe and other double ending applications
- General purpose structural and multiple pass welds
- Storage tanks using L-61® or LA-85

## RECOMMENDED WIRES

Mild Steel

Lincolnweld® L-50®, L-56®, L-60, L-61®, LA-71, L-S3

Low Alloy Steel

Lincolnweld® L-70, LA-75, LA-85

## PRODUCT INFORMATION

Basicity Index: 1.1

Density: 1.4 g/cm<sup>3</sup>

## FLUX COMPOSITION<sup>(1)</sup>

	%SiO <sub>2</sub>	%MnO	%MgO	%CaF <sub>2</sub>	%Na <sub>2</sub> O	%Al <sub>2</sub> O <sub>3</sub>	%CaO	%TiO <sub>2</sub>	% Metal Alloys
Lincolnweld® 860®	19	11	17	12	2	32	2	2	3 max

## AWS TEST RESULTS<sup>(1)</sup>

Flux/Wire Combination	Weld Condition	Yield Strength <sup>(2)</sup> MPa (ksi)	Tensile Strength MPa (ksi)	Elongation (%)	Charpy V-Notch		AWS Classification (A5.17/A5.23)
					J (ft·lbf)	@ °C (°F)	
L-50®	As-welded	430 (62)	520 (75)	30	84 (62)	-29 (-20)	F7A2-EM13K-H4
L-56®	As-welded	470 (68)	590 (86)	28	61 (45)	-29 (-20)	F7A2-EH11K-H4
L-56®	Stress-relieved <sup>(3)</sup>	440 (64)	570 (82)	29	80 (59)	-29 (-20)	F7P2-EH11K-H4
L-60	As-welded	370 (54)	450 (65)	34	138 (102)	-29 (-20)	F6A2-EL12-H4
L-61®	As-welded	410 (59)	500 (72)	31	58 (43)	-40 (-40)	F7A8-EM12K-H8
L-61®	Stress-relieved <sup>(3)</sup>	340 (49)	440 (64)	37	222 (164)	-46 (-50)	F8A4-EA1-A3-H8
L-S3	As-welded	500 (73)	590 (86)	28	52 (38)	-29 (-20)	F7A2-EH12K-H4
LA-71	As-welded	450 (65)	540 (78)	30	110 (81)	-29 (-20)	F7A2-EM14K-H4
LA-71	Stress relieved <sup>(3)</sup>	400 (58)	520 (75)	32	119 (88)	-29 (-20)	F7P2-EM14K-H4
L-70	As-welded	450 (65)	550 (80)	28	54 (40)	-29 (-20)	F7A2-EA1-A2-H4
L-70	Stress-relieved <sup>(3)</sup>	430 (62)	520 (76)	31	47 (35)	-29 (-20)	F7P2-EA1-A2-H4
LA-75	As-welded	460 (66)	550 (80)	32	107 (79)	-29 (-20)	F7A2-ENi1K-Ni1-H4
LA-75	Stress-relieved <sup>(3)</sup>	410 (60)	540 (79)	30	99 (73)	-29 (-20)	F7P2-ENi1K-Ni1-H4
LA-85	As-welded	520 (75)	600 (87)	26	38 (28)	-40 (-40)	F8A4-ENi5-Ni5-H4

<sup>(1)</sup>See test results disclaimer <sup>(2)</sup>Measured with 0.2% offset <sup>(3)</sup>Stress-relieved for 1 hour at 621°C (1150°F)  
NOTE: For the most up-to-date AWS certificates of conformance please visit [www.lincolnelectric.com](http://www.lincolnelectric.com)

# LINCOLNWELD® 865™

800 Series Neutral Flux ■ EN ISO 14174 – S A AB 1; EN ISO 14174 – S A AR 1

## KEY FEATURES

- General purpose flux designed to weld butt joints and flat and horizontal fillets
- When used with Lincolnweld® L-50® or L-61®, it is capable of producing 480 MPa (70 ksi) tensile strength after stress relief
- Small loss of strength when used in the stress-relieved condition
- Actual (Type 3.1) certificates for each lot of flux showing chemical composition, particle size and moisture level are available in the certificate center of lincolnelectric.com

## PACKAGING

50 lb (22.7 kg) Bag

EDS27857

## TYPICAL APPLICATIONS

- Butt joints and flat and horizontal fillets
- Pair with Lincolnweld® L-61® on A516 steels

## RECOMMENDED WIRES

Mild Steel  
Lincolnweld® L-50®, L-61®, LA-71  
Low Alloy Steel  
Lincolnweld® LA-75

## PRODUCT INFORMATION

Basicity Index: 1.0  
Density: 1.3 g/cm<sup>3</sup>

## FLUX COMPOSITION<sup>(1)</sup>

	%SiO <sub>2</sub>	%MnO	%MgO	%CaF <sub>2</sub>	%Na <sub>2</sub> O	%Al <sub>2</sub> O <sub>3</sub>	%TiO <sub>2</sub>	% Metal Alloys
Lincolnweld® 865™	11	1	14	19	2	37	12	3 max

## AWS TEST RESULTS<sup>(1)</sup>

Flux/Wire Combination	Weld Condition	Yield Strength <sup>(2)</sup> MPa (ksi)	Tensile strength MPa (ksi)	Elongation (%)	Charpy V-Notch		AWS Classification (A5.17/A5.23)
					J (ft-lbf)	@ °C (°F)	
L-50®	As-welded	500 (72)	580 (84)	27	53 (39)	-29 (-20)	F7A2-EM13K-H8
L-50®	Stress-relieved <sup>(3)</sup>	440 (64)	550 (80)	30	28 (21)	-46 (-50)	F7P5-EM13K-H8
L-61®	As-welded	480 (70)	570 (83)	22	85 (63)	-29 (-20)	F7A2-EM12K-H8
L-61®	Stress-relieved <sup>(3)</sup>	450 (65)	550 (80)	30	117 (86)	-29 (-20)	F7P2-EM12K-H8
LA-71	As-welded	540 (78)	630 (91)	26	73 (54)	-29 (-20)	F7A2-EM14K-H8
LA-75	As-welded	520 (76)	600 (87)	23	77 (57)	-29 (-20)	F8A2-ENi1K-G-H8
LA-75	Stress-relieved <sup>(3)</sup>	500 (73)	610 (88)	27	79 (58)	-29 (-20)	F8P2-ENi1K-G-H8

<sup>(1)</sup>See test results disclaimer <sup>(2)</sup>Measured with 0.2% offset. <sup>(3)</sup>Stress-relieved for 1 hour at 621°C (1150°F).  
NOTE: For the most up-to-date AWS certificates of conformance please visit [www.lincolnelectric.com](http://www.lincolnelectric.com)



# LINCOLNWELD® 880™

800 Series Neutral Flux ▪ EN ISO 14174 – S A AS 1; EN ISO 14174 – S A FB 1

## KEY FEATURES

- Can be used for both joining and hardfacing welding
- Optimal bead appearance when used with solid low alloy steel electrodes with a minimum of 0.20% silicon
- Use with both solid and flux cored wires
- Actual (Type 3.1) certificates for each lot of flux showing chemical composition, particle size and moisture level are available in the certificate center of [lincolnelectric.com](http://lincolnelectric.com)

## PACKAGING

50 lb (22.7 kg) Bag ED027866  
550 lb (249.5 kg) Steel Drum ED028322

## TYPICAL APPLICATIONS

- Applications requiring smooth bead appearance
- Hardfacing applications

## RECOMMENDED WIRES

Low Alloy Steel  
Lincolnweld® LA-75, LA-90, LA-100, LAC-B2,  
LAC-M2, LAC-Ni2

## PRODUCT INFORMATION

Basicity Index: 2.0  
Density: 1.4 g/cm<sup>3</sup>

## FLUX COMPOSITION<sup>(1)</sup>

	%SiO <sub>2</sub>	%MgO	%CaF <sub>2</sub>	%Na <sub>2</sub> O	%Al <sub>2</sub> O <sub>3</sub>	%CaO	%ZrO <sub>2</sub>	% Metal Alloys
Lincolnweld® 880™	17	27	27	2	16	2	7	5 max

## AWS TEST RESULTS<sup>(1)</sup>

Flux/Wire Combination	Weld Condition	Yield Strength <sup>(2)</sup> MPa (ksi)	Tensile Strength MPa (ksi)	Elongation (%)	Charpy V-Notch		AWS Classification (A5.17/A5.23)
					J (ft•lbf)	@ °C (°F)	
LA-75	As-welded	430 (62)	530 (77)	30	98 (72)	-62 (-80)	F7A8-ENi1K-Ni1-H8
LA-90	As-welded	540 (79)	640 (93)	28	61 (45)	-40 (-40)	F8A4-EA3K-A4-H8
LA-100	As-welded	630 (92)	700 (101)	28	53 (39)	-40 (-40)	F9A4-EM2-M2-H8
LAC-B2	Stress relieved <sup>(4)</sup>	480 (70)	590 (85)	26	135 (100)	-29 (-20)	F8P2-ECB2-B2-H8
LAC-M2	As-welded	730 (106)	820 (119)	18	72 (53)	-51 (-60)	F11A6-ECM2-M2-H8
LAC-Ni2	As-welded	460 (66)	540 (79)	29	140 (103)	-51 (-60)	F7A6-ECNi2-Ni2-H8
LAC-Ni2	Stress relieved <sup>(3)</sup>	430 (63)	540 (78)	30	95 (70)	-73 (-100)	F7P10-ECNi2-Ni2-H8

<sup>(1)</sup>See test results disclaimer <sup>(2)</sup>Measured with 0.2% offset. <sup>(3)</sup>Stress-relieved for 1 hour at 621°C (1150°F). <sup>(4)</sup>Stress-relieved for 1 hour at 691°C (1275°F).  
NOTE: For the most up-to-date AWS certificates of conformance please visit [www.lincolnelectric.com](http://www.lincolnelectric.com)

# LINCOLNWELD® 880M®

800 Series Neutral Flux ▪ EN ISO 14174 – S A FB 1

## KEY FEATURES

- A basic flux which features industry proven results in multiple pass applications
- Recommended for welding with solid mild steel and low alloy electrodes, as well as Lincoln's LAC series of low alloy flux-cored electrodes
- Good deep groove slag removal
- Excellent choice for single arc AC submerged arc welding
- Actual (Type 3.1) certificates for each lot of flux showing chemical composition, particle size and moisture level are available in the certificate center of lincolnelectric.com

## PACKAGING

50 lb (22.7 kg) Plastic Bag

ED031853

## TYPICAL APPLICATIONS

- Tandem arc applications for offshore fabrication
- Jobs requiring 480 MPa (70 ksi) tensile strength after stress relief when used with L-56®, L-S3, or LA-71

## RECOMMENDED WIRES

Mild Steel

Lincolnweld® L-50®, L-56®, LA-71, L-S3

Low Alloy Steel

Lincolnweld® LA-75, LA-85, LA-90, LA-92, LA-93, LA-100, LAC-B2, LAC-M2, LAC-Ni2

## PRODUCT INFORMATION

Basicity Index: 3.3

Density: 1.2 g/cm<sup>3</sup>

## FLUX COMPOSITION<sup>(1)</sup>

	%SiO <sub>2</sub>	%MnO	%MgO	%CaF <sub>2</sub>	%Na <sub>2</sub> O	%Al <sub>2</sub> O <sub>3</sub>	%CaO	%K <sub>2</sub> O	% Metal Alloys
Lincolnweld® 880M®	12	1	29	29	1	18	8	1	1 max

## AWS TEST RESULTS<sup>(1)</sup>

Flux/Wire Combination	Weld Condition	Yield Strength <sup>(2)</sup> MPa (ksi)	Tensile Strength MPa (ksi)	Elongation (%)	Charpy V-Notch		AWS Classification (A5.17/A5.23)
					J (ft•lbf)	@ °C (°F)	
L-50®	As-welded	410 (59)	510 (74)	32	263 (194)	-62 (-80)	F7A8-EM13K-H8
L-56®	As-welded	480 (69)	580 (85)	31	121 (89)	-51 (-60)	F7A6-EH11K-H8
L-56®	Stress-relieved <sup>(3)</sup>	400 (58)	540 (78)	32	158 (116)	-51 (-60)	F7P6-EH11K-H8
L-S3	As-welded	400 (58)	510 (74)	32	264 (195)	-51 (-60)	F7A6-EH12K-H8
LA-71	As-welded	480 (70)	570 (82)	29	143 (105)	-62 (-80)	F7A8-EM14K-H8
LA-71	Stress-relieved <sup>(3)</sup>	430 (63)	550 (80)	31	164 (121)	-62 (-80)	F7P8-EM14K-H8
LA-75	As-welded	440 (64)	550 (80)	31	167 (123)	-62 (-80)	F7A8-ENi1K-Ni1-H8
LA-85	As-welded	520 (76)	610 (88)	24	57 (42)	-51 (-60)	F7A6-ENi5-Ni5-H8
LA-85	Stress-relieved <sup>(3)</sup>	490 (71)	590 (85)	27	145 (107)	-62 (-80)	F7P8-ENi5-Ni5-H8
LA-90	As-welded	580 (84)	680 (99)	26	68 (50)	-51 (-60)	F9A6-EA3K-A3-H8
LA-90	Stress-relieved <sup>(3)</sup>	520 (75)	630 (91)	28	145 (107)	-62 (-80)	F9P8-EA3K-A3-H8
LA-92	Stress-relieved <sup>(4)</sup>	460 (66)	570 (82)	28	178 (131)	-29 (-20)	F7P2-EB2R-B2-H8
LA-93	Stress-relieved <sup>(4)</sup>	510 (74)	610 (88)	26	214 (158)	-18 (0)	F7P0-EB3R-B3-H8
LA-100	As-welded	680 (98)	730 (106)	25	129 (95)	-51 (-60)	F9A6-EM2-M2-H8
LAC-B2	Stress-relieved <sup>(4)</sup>	500 (72)	600 (87)	25	144 (106)	-29 (-20)	F8P2-ECB2-B2-H8
LAC-M2	As-welded	760 (110)	820 (119)	23	83 (61)	-51 (-60)	F11A6-ECM2-M2-H8
LAC-Ni2	As-welded	510 (73)	600 (87)	22	77 (57)	-73 (-100)	F7A10-ECNi2-Ni2-H8
LAC-Ni2	Stress-relieved <sup>(3)</sup>	480 (69)	570 (83)	28	103 (76)	-73 (-100)	F7P10-ECNi2-Ni2-H8

<sup>(1)</sup>See test results disclaimer <sup>(2)</sup>Measured with 0.2% offset. <sup>(3)</sup>Stress-relieved for 1 hour at 621 °C (1150 °F). <sup>(4)</sup>Stress-relieved for 1 hour at 691 °C (1275 °F).  
NOTE: For the most up-to-date AWS certificates of conformance please visit [www.lincolnelectric.com](http://www.lincolnelectric.com)

# LINCOLNWELD® 882™

800 Series Neutral Flux ▪ EN ISO 14174 – S A AS 1; EN ISO 14174 – S A AS 2

## KEY FEATURES

- Designed for a variety of welding applications and is known for providing consistent mechanical properties
- Recommended for stainless steel welding and can be paired with both mild and low alloy steel electrodes
- Smooth bead appearance
- Actual (Type 3.1) certificates for each lot of flux showing chemical composition, particle size and moisture level are available in the certificate center of lincolnelectric.com

## PACKAGING

50 lb (22.7 kg) Bag

ED027859

## TYPICAL APPLICATIONS

- Single wire or tandem welding
- Used for welding of stainless, mild and low alloy steel
- Excellent for multiple pass fillet welds

## RECOMMENDED WIRES

Mild Steel

Lincolnweld® L-50®, L-56®, L-60, L-61®, LA-71, L-S3

Low Alloy Steel

Lincolnweld® L-70, LA-75, LA-85, LA-92, LA-93, LAC-Ni2

## PRODUCT INFORMATION

Basicity Index: 1.6

Density: 1.2 g/cm<sup>3</sup>

## FLUX COMPOSITION<sup>(1)</sup>

	%SiO <sub>2</sub>	%MnO	%MgO	%CaF <sub>2</sub>	%Na <sub>2</sub> O	%Al <sub>2</sub> O <sub>3</sub>	%CaO	%ZrO <sub>2</sub>	% Metal Alloys
Lincolnweld® 882™	16	1	22	24	2	24	1	7	3 max

## AWS TEST RESULTS<sup>(1)</sup>

Flux/Wire Combination	Weld Condition	Yield Strength <sup>(2)</sup> MPa (ksi)	Tensile Strength MPa (ksi)	Elongation (%)	Charpy V-Notch		AWS Classification (A5.17/A5.23)
					J (ft•lbf)	@ °C (°F)	
L-50°	As-welded	420 (61)	520 (76)	29	130 (96)	-51 (-60)	F7A6-EM13K-H8
L-56°	As-welded	500 (73)	600 (87)	28	92 (68)	-40 (-40)	F7A4-EH11K-H8
L-56°	Stress-relieved <sup>(3)</sup>	420 (61)	560 (81)	30	47 (35)	-46 (-50)	F7P5-EH11K-H8
L-60	As-welded	370 (54)	460 (67)	32	207 (153)	-51 (-60)	F6A6-EL12-H8
L-61°	As-welded	400 (58)	500 (72)	31	190 (140)	-51 (-60)	F7A6-EM12K-H8
L-S3	As-welded	410 (60)	520 (76)	28	130 (96)	-51 (-60)	F7A6-EH12K-H8
LA-71	As-welded	480 (69)	570 (82)	31	61 (45)	-51 (-60)	F7A6-EM14K-H8
LA-71	Stress-relieved <sup>(3)</sup>	430 (62)	550 (80)	32	70 (52)	-51 (-60)	F7P6-EM14K-H8
L-70	Stress-relieved <sup>(3)</sup>	450 (65)	550 (80)	30	76 (56)	-40 (-40)	F7P4-EA1-A2-H8
LA-75	As-welded	430 (62)	540 (79)	32	133 (98)	-40 (-40)	F7A4-ENi1K-Ni1-H8
LA-85	As-welded	510 (74)	610 (88)	25	88 (65)	-40 (-40)	F7A4-ENi5-Ni5-H8
LA-85	Stress-relieved <sup>(3)</sup>	500 (73)	590 (86)	26	102 (75)	-40 (-40)	F7P4-ENi5-Ni5-H8
LA-92	Stress-relieved <sup>(4)</sup>	520 (75)	610 (89)	27	83 (61)	-29 (-20)	F7P2-EB2R-B2-H8
LA-93	Stress-relieved <sup>(4)</sup>	610 (88)	700 (101)	23	214 (158)	-18 (0)	F9P0-EB3R-B3-H8
LAC-Ni2	As-welded	570 (83)	660 (95)	20	72 (53)	-40 (-40)	F8A4-ECNi2-Ni2-H8
LAC-Ni2	Stress-relieved <sup>(3)</sup>	500 (73)	600 (87)	25	100 (74)	-40 (-40)	F7P4-ECNi2-Ni2-H8

<sup>(1)</sup>See test results disclaimer <sup>(2)</sup>Measured with 0.2% offset. <sup>(3)</sup>Stress-relieved for 1 hour at 621°C (1150°F). <sup>(4)</sup>Stress-relieved for 1 hour at 691°C (1275°F).  
NOTE: For the most up-to-date AWS certificates of conformance please visit [www.lincolnelectric.com](http://www.lincolnelectric.com)

# LINCOLNWELD® 888™

800 Series Neutral Flux ▪ EN ISO 14174 – S A Z

## KEY FEATURES

- Designed for deep groove slag removal in critical applications
- Low H4 diffusible hydrogen levels
- Moisture resistant packaging
- Charpy V-Notch and CTOD test results available for most alloy systems
- Actual (Type 3.1) certificates for each lot of flux showing chemical composition, particle size and moisture level are available in the certificate center of lincolnelectric.com

## PACKAGING

50 lb (22.7 kg) Plastic Bag ED031596  
2600 lb (1179 kg) Foil Lined Bulk Bag ED033490

## RECOMMENDED WIRES

Mild Steel  
Lincolnweld® L-50®, L-56®, L-S3, L-61®, LA-71  
Low Alloy Steel  
Lincolnweld® L-70, LA-75, LA-84, LA-85, LA-90, LA-100,  
LAC-Ni2, LAC-M2, LAC-B2, LAC-690

## PRODUCT INFORMATION

Basicity Index: 2.2  
Density: 1.3 g/cm<sup>3</sup>

## TYPICAL APPLICATIONS

- Excellent operation with multiple arcs
- Offshore
- Structural fabrication
- Shipbuilding

## FLUX COMPOSITION<sup>(1)</sup>

	%SiO <sub>2</sub>	%MnO	%MgO	%CaF <sub>2</sub>	%Na <sub>2</sub> O	%Al <sub>2</sub> O <sub>3</sub>	%CaO	%FeO	%K <sub>2</sub> O	% Metal Alloys
Lincolnweld® 888™	18	1	27	25	2	19	5	1	2	3 max

## AWS TEST RESULTS<sup>(1)</sup>

Flux/Wire Combination	Weld Condition	Yield Strength <sup>(2)</sup> MPa (ksi)	Tensile Strength MPa (ksi)	Elongation (%)	Charpy V-Notch		AWS Classification (A5.17/A5.23)
					J (ft•lbf)	@ °C (°F)	
L-50°	As-welded	430 (62)	540 (78)	31	122 (90)	-62 (-80)	F7A8-EM13K-H4
L-50°	Stress-relieved <sup>(3)</sup>	370 (53)	510 (74)	32	187 (138)	-62 (-80)	F6P8-EM13K-H4
L-56°	As-welded	510 (74)	610 (88)	29	71 (52)	-51 (-60)	F8A6-EH11K-H4
L-56°	Stress-relieved <sup>(3)</sup>	410 (59)	540 (79)	32	118 (87)	-62 (-80)	F7P8-EH11K-H4
L-61°	As-welded	420 (61)	520 (75)	31	121 (89)	-51 (-60)	F7A6-EM12K-H4
L-S3	As-welded	480 (70)	570 (83)	33	70 (52)	-62 (-80)	F7A8-EH12K-H4
L-S3	Stress-relieved <sup>(3)</sup>	370 (54)	510 (74)	33	165 (122)	-62 (-80)	F6P8-EH12K-H4
LA-71	As-welded	520 (75)	610 (89)	28	68 (50)	-51 (-60)	F7A6-EM14K-H4
LA-71	Stress-relieved <sup>(3)</sup>	410 (60)	540 (78)	32	134 (99)	-62 (-80)	F7P8-EM14K-H4
L-70	As-welded	510 (74)	600 (87)	29	60 (45)	-40 (-40)	F7A4-EA1-A2-H4
L-70	Stress-relieved <sup>(3)</sup>	470 (69)	570 (83)	31	126 (93)	-40 (-40)	F7P4-EA1-A2-H4
LA-75	As-welded	470 (68)	580 (84)	31	122 (90)	-62 (-80)	F7A8-ENi1K-Ni1-H4
LA-84	As-welded	630 (92)	720 (105)	23	77 (57)	-62 (-80)	F9A8-EF3-F3-H4
LA-84	Stress-relieved <sup>(3)</sup>	580 (84)	670 (98)	26	34 (25)	-51 (-60)	F8P6-EF3-F3-H4
LA-85	As-welded	540 (78)	640 (92)	26	79 (58)	-51 (-60)	F8A6-ENi5-Ni5-H4
LA-85	Stress-relieved <sup>(3)</sup>	500 (72)	590 (86)	27	76 (56)	-51 (-60)	F7P6-ENi5-Ni5-H4
LA-90	As-welded	610 (89)	700 (102)	26	56 (41)	-51 (-60)	F9A6-EA3K-A3-H4
LA-100	As-welded	690 (100)	760 (111)	25	61 (45)	-40 (-40)	F10A4-EM2-M2-H4
LAC-M2	As-welded	860 (124)	930 (135)	15	63 (46)	-62 (-80)	F12A8-ECG-G-H8
LAC-Ni2	As-welded	540 (78)	630 (92)	20	56 (42)	-62 (-80)	F8A8-ECNi2-Ni2-H8
LAC-Ni2	Stress-relieved <sup>(3)</sup>	480 (70)	580 (84)	27	64 (47)	-73 (-100)	F7P10-ECNi2-Ni2-H8
LAC-690	As-welded	800 (116)	860 (124)	22	91 (67)	-73 (-100)	F11A10-ECG-G-H4
LAC-690	Stress-relieved <sup>(3)</sup>	707 (103)	776 (113)	21	51 (37)	-51 (-60)	F11P6-ECG-G-H4

<sup>(1)</sup>See test results disclaimer <sup>(2)</sup>Measured with 0.2% offset <sup>(3)</sup>Stress-relieved for 1 hour at 621°C (1150°F) <sup>(4)</sup>Stress-relieved for 1 hour at 691°C (1275°F)  
NOTE: For the most up-to-date AWS certificates of conformance please visit [www.lincolnelectric.com](http://www.lincolnelectric.com)

# LINCOLNWELD® 8500™

800 Series Neutral Flux ■ EN ISO 14174 – S A FB 1

## KEY FEATURES

- Capable of providing impact properties necessary for thick weld joints from root to cap pass
- Operates well on AC and multiple arcs with good resistance to nitrogen porosity
- Capable of producing weld deposits with impact properties exceeding 27 J (20 ft•lbf) at -62°C (-80°F)
- CTOD data available for this flux with many alloy systems
- Actual (Type 3.1) certificates for each lot of flux showing chemical composition, particle size and moisture level are available in the certificate center of lincolnelectric.com

## PACKAGING

50 lb (22.7 kg) Plastic Bag

ED031854

## TYPICAL APPLICATIONS

- Fabrication of offshore drilling platforms
- Multiple pass welding
- Single and multiple arc welding

## RECOMMENDED WIRES

Mild Steel

Lincolnweld® L-50®, L-56®, L-61®, L-S3, LA-71

Low Alloy Steel

Lincolnweld® LA-85, LA-90, LA-92

## PRODUCT INFORMATION

Basicity Index: 2.9

Density: 1.3 g/cm<sup>3</sup>

## FLUX COMPOSITION<sup>(1)</sup>

	%SiO <sub>2</sub>	%MnO	%MgO	%CaF <sub>2</sub>	%Na <sub>2</sub> O	%Al <sub>2</sub> O <sub>3</sub>	%CaO	%K <sub>2</sub> O	%TiO <sub>2</sub>	% Metal Alloys
Lincolnweld® 8500™	13	1	30	24	2	19	8	1	1	1 max

## AWS TEST RESULTS<sup>(1)</sup>

Flux/Wire Combination	Weld Condition	Yield Strength <sup>(2)</sup> MPa (ksi)	Tensile Strength MPa (ksi)	Elongation (%)	Charpy V-Notch		AWS Classification (A5.17/A5.23)
					J (ft•lbf)	@ °C (°F)	
L-50°	As-welded	430 (63)	520 (76)	32	129 (95)	-62 (-80)	F7A8-EM13K-H8
L-56°	As-welded	470 (68)	570 (82)	31	132 (97)	-62 (-80)	F7A8-EH11K
L-56°	Stress-relieved <sup>(3)</sup>	430 (62)	540 (79)	33	151 (111)	-62 (-80)	F7P8-EH11K
L-61°	As-welded	400 (58)	480 (70)	31	168 (124)	-51 (-60)	F7A6-EM12K-H8
L-S3	As-welded	460 (67)	570 (82)	29	91 (67)	-62 (-80)	F7A8-EH12K-H8
L-70	As-welded	450 (65)	520 (75)	29	211 (156)	-40 (-40)	F7A4-EA1-G-H8
LA-71	As-welded	450 (66)	550 (80)	30	155 (115)	-62 (-80)	F7A8-EM14K-H8
LA-71	Stress-relieved <sup>(3)</sup>	420 (61)	520 (75)	32	220 (162)	-62 (-80)	F7P8-EM14K-H8
LA-85	As-welded	510 (74)	590 (86)	29	155 (114)	-62 (-80)	F8A8-ENi5-Ni5-H8
LA-85	Stress-relieved <sup>(3)</sup>	500 (72)	590 (85)	28	134 (99)	-51 (-60)	F7P6-ENi5-Ni5-H8
LA-90	As-welded	670 (97)	590 (85)	24	84 (62)	-29 (-20)	F9A2-EA3K-A3-H8
LA-92	Stress-relieved <sup>(4)</sup>	550 (80)	640 (93)	26	209 (154)	-18 (0)	F8P0-EB2-B2-H8

<sup>(1)</sup>See test results disclaimer <sup>(2)</sup>Measured with 0.2% offset. <sup>(3)</sup>Stress-relieved for 1 hour at 621°C (1150°F). <sup>(4)</sup>Stress-relieved for 1 hour at 691°C (1275°F).

NOTE 1: For the most up-to-date AWS certificates of conformance please visit [www.lincolnelectric.com](http://www.lincolnelectric.com) NOTE 2: This product contains micro-alloying elements. Additional information available upon request.

# LINCOLNWELD® MIL800-H™

800 Series Neutral Flux ■ EN ISO 14174 – S A CS 1; EN ISO 14174 – S A FB 1

## KEY FEATURES

- Capable of providing industry leading H<sub>2</sub> diffusible hydrogen levels
- Designed for low temperature applications
- Recommended for both single and multiple arc welding of both butt and fillet welds
- Actual (Type 3.1) certificates for each lot of flux showing chemical composition, particle size and moisture level are available in the certificate center of lincolnelectric.com

## PACKAGING

50 lb (22.7 kg)

Hermetically Sealed Foil Bag

ED035892

## TYPICAL APPLICATIONS

- HY-80 and HSLA-80 steels with Lincolnweld® LA-100 wire
- Horizontal and flat fillet welds
- Single and multiple arc welding
- High strength or highly restrained weldments where delayed cracking is a concern

## RECOMMENDED WIRES

Mild Steel

Lincolnweld® L-53, LA-71

Low Alloy Steel

Lincolnweld® LA-75, LA-85, LA-90, LA-93, LA-100

## PRODUCT INFORMATION

Basicity Index: 3.2

Density: 1.3 g/cm<sup>3</sup>

## FLUX COMPOSITION<sup>(1)</sup>

	%SiO <sub>2</sub>	%MnO	%MgO	%CaF <sub>2</sub>	%Na <sub>2</sub> O	%Al <sub>2</sub> O <sub>3</sub>	%CaO	%K <sub>2</sub> O	% Metal Alloys
Lincolnweld® MIL800-H™	13	1	34	23	1	16	8	1	1 max

## AWS TEST RESULTS<sup>(1)</sup>

Flux/Wire Combination	Weld Condition	Yield Strength <sup>(2)</sup> MPa (ksi)	Tensile Strength MPa (ksi)	Elongation (%)	Charpy V-Notch		AWS Classification (A5.17/A5.23)
					J (ft-lbf)	@ °C (°F)	
L-53	As-welded	500 (73)	610 (88)	27	76 (56)	-62 (-80)	F7A8-EH12K-H2
L-53	Stress-relieved <sup>(3)</sup>	440 (64)	570 (82)	30	118 (87)	-62 (-80)	F7P8-EH12K-H2
LA-71	As-welded	470 (68)	570 (82)	30	163 (120)	-51 (-60)	F7A6-EM14K-H2
LA-71	Stress-relieved <sup>(3)</sup>	420 (61)	540 (79)	32	193 (140)	-51 (-60)	F7P6-EM14K-H2
LA-75	As-welded	460 (67)	560 (82)	30	156 (115)	-62 (-80)	F7A8-ENi1K-Ni1-H2
LA-85	As-welded	570 (82)	660 (95)	25	108 (80)	-62 (-80)	F8A8-ENi5-Ni5-H2
LA-85	Stress-relieved <sup>(3)</sup>	540 (78)	630 (92)	26	83 (61)	-62 (-80)	F8P8-ENi5-Ni5-H2
LA-90	As-welded	620 (90)	710 (103)	26	77 (57)	-51 (-60)	F9A6-EA3K-A3-H2
LA-90	Stress-relieved <sup>(3)</sup>	590 (86)	690 (100)	26	84 (62)	-51 (-60)	F9P6-EA3K-A3-H2
LA-93	Stress-relieved <sup>(4)</sup>	580 (84)	690 (99)	23	34 (25)	-29 (-20)	F9P2-EB3R-B3R-H2
LA-100	As-welded	670 (97)	780 (112)	25	107 (79)	-51 (-60)	F10A6-EM2-M2-H2
LAC-690	As-welded	750 (109)	830 (120)	21	121 (90)	-51 (-60)	F11A6-ECG-G-H4

<sup>(1)</sup>See test results disclaimer. <sup>(2)</sup>Measured with 0.2% offset. <sup>(3)</sup>Stress-relieved for 1 hour at 621°C (1150°F). <sup>(4)</sup>Stress-relieved for 1 hour at 691°C (1275°F).

NOTE: For the most up-to-date AWS certificates of conformance please visit [www.lincolnelectric.com](http://www.lincolnelectric.com)

# LINCOLNWELD® 812-SRC™

800 Series Neutral Flux ▪ EN ISO 14174 – S A FB 1

## KEY FEATURES

- Carbon-neutral flux designed to provide excellent mechanical properties after extended stress-relief
- Industry leading low H<sub>4</sub> diffusible hydrogen levels
- Smooth bead appearance and excellent slag release
- Excellent resistance to moisture pick up
- Actual (Type 3.1) certificates for each lot of flux showing chemical composition, particle size and moisture level are available in the certificate center of lincolnelectric.com

## PACKAGING

50 lb (22.7 kg) Plastic Bag      ED034171

## TYPICAL APPLICATIONS

- Offshore applications with extended post-weld heat treatment (PWHT)
- Quench and tempered steels such as AISI 4130, 8620, and similar chemistries

## RECOMMENDED WIRES

Low Alloy Electrodes  
Lincolnweld® LA-84

## PRODUCT INFORMATION

Basicity Index: 2.2  
Density: 1.3 g/cm<sup>3</sup>

## FLUX COMPOSITION<sup>(1)</sup>

	%SiO <sub>2</sub>	%MnO	%MgO	%CaF <sub>2</sub>
Lincolnweld® 812-SRC™	16	3	30	19
	%Na <sub>2</sub> O	%Al <sub>2</sub> O <sub>3</sub>	%CaO	% Metal Alloys
Lincolnweld® 812-SRC™	2	22	4	3 max

## AWS TEST RESULTS<sup>(1)</sup>

Flux/Wire Combination	Weld Condition	Yield Strength <sup>(2)</sup> MPa (ksi)	Tensile Strength MPa (ksi)	Elongation (%)	Charpy V-Notch		AWS Classification (A5.17/A5.23)
					J (ft•lbf)	@ °C (°F)	
LA-84	As-welded	680(98)	810(117)	21	81(60)	-51° (-60°)	F10A6-EF3-F3-H4
LA-84	As-welded	680(98)	810(117)	21	81(60)	-51° (-60°)	F10A6-EG-F3-H4
LA-84	Stress-relieved	650(94)	740(107)	25	73(54)	-51° (-60°)	F10P6-EF3-F3-H4
LA-84	Stress-relieved	650(94)	740(107)	25	73(54)	-51° (-60°)	F9P6-EF3-F3-H4
AK-10	Stress-relieved	660 (95)	750 (108)	25	55 (41)	-40° (-40°)	F10P4-EG-G-H4

<sup>(1)</sup>See test results disclaimer <sup>(2)</sup>Measured with 0.2% offset. NOTE 1: For the most up-to-date AWS certificates of conformance please visit [www.lincolnelectric.com](http://www.lincolnelectric.com)

# LINCOLNWELD® 960®

Special Neutral Flux ■ EN ISO 14174 – S A AB 1

## KEY FEATURES

- Low cost, general purpose flux designed to weld butt joints and both single and multiple pass fillets
- Recommended for automatic and semiautomatic submerged arc welding
- A versatile, cost-effective flux that can be used with many alloy systems
- Can be used on weathering steels when combined with Lincolnweld® LA-75
- Actual (Type 3.1) certificates for each lot of flux showing chemical composition, particle size and moisture level are available in the certificate center of lincolnelectric.com

## PACKAGING

50 lb (22.7 kg) Bag                      ED022412, ED030841\*

\*Tested Material

## TYPICAL APPLICATIONS

- Single and multiple pass welding
- Fillet and butt welds with unlimited plate thickness
- Can weld steel with heavy scale or rust when used with Lincolnweld® L-50® wire

## RECOMMENDED WIRES

Mild Steel  
Lincolnweld® L-50®, L-61®, LA-71  
Low Alloy Steel  
Lincolnweld® LA-75, LA-85, LA-93, LA-100

## PRODUCT INFORMATION

Basicity Index:            1.1  
Density:                    1.4 g/cm<sup>3</sup>

## AWS D1.8 AND FEMA 353

Approved when paired with the following wires:

- 3/32-5/32 in (2.4-4.0 mm) Lincolnweld® L-56®
- 3/32-5/32 in (2.4-4.0 mm) Lincolnweld® LA-85

## FLUX COMPOSITION<sup>(1)</sup>

	%SiO <sub>2</sub>	%MnO	%MgO	%CaF <sub>2</sub>	%Na <sub>2</sub> O	%Al <sub>2</sub> O <sub>3</sub>	%CaO	%TiO <sub>2</sub>	% Metal Alloys
Lincolnweld® 960®	21	10	21	10	2	31	1	1	3 max

## AWS TEST RESULTS<sup>(1)</sup>

Flux/Wire Combination	Weld Condition	Yield Strength <sup>(2)</sup> MPa (ksi)	Tensile Strength MPa (ksi)	Elongation (%)	Charpy V-Notch		AWS Classification (A5.17/A5.23)
					J (ft•lbf)	@ °C (°F)	
L-50®	As-welded	460 (66)	570 (83)	27	58 (43)	-29 (-20)	F7A2-EM13K-H4
L-56	As-welded	460 (67)	590 (86)	29	65 (48)	-29 (-20)	F7A2-EH11K-H4
LA-71	As-welded	460 (66)	570 (82)	29	44 (32)	-29 (-20)	F7A2-EM14K-H4
LA-71	Stress-relieved <sup>(3)</sup>	420 (61)	540 (79)	31	89 (66)	-29 (-20)	F7P2-EM14K-H4
LA-75	As-welded	480 (69)	600 (87)	30	76 (56)	-29 (-20)	F7P6-ENi1K-Ni1-H4
LA-75	Stress-relieved <sup>(3)</sup>	420 (61)	550 (80)	29	53 (39)	-51 (-60)	F8A2-ENi1K-Ni1-H4
LA-85	As-welded	520 (76)	640 (93)	24	57 (42)	-29 (-20)	F7P5-ENi5-G-H4
LA-85	Stress-relieved <sup>(3)</sup>	500 (73)	610 (88)	25	39 (29)	-46 (-50)	F8A2-ENi5-G-H4
LA-100	As-welded	680 (99)	740 (108)	25	33 (24)	-40 (-40)	F10A4-EM2-G-H4

<sup>(1)</sup>See test results disclaimer <sup>(2)</sup>Measured with 0.2% offset. <sup>(3)</sup>Stress-relieved for 1 hour at 621°C (1150°F). <sup>(4)</sup>Stress-relieved for 1 hour at 691°C (1275°F).  
NOTE: For the most up-to-date AWS certificates of conformance please visit [www.lincolnelectric.com](http://www.lincolnelectric.com)



# LINCOLNWELD® 980™

Special Neutral Flux ■ EN ISO 14174 – S A AB 1; EN ISO 14174 – S A AR 1

## KEY FEATURES

- Combines many of the features of the 700 and 800 series fluxes and is ideal for semiautomatic submerged arc welding
- Exceptional resistance to flash-through and porosity caused by arc blow in a variety of applications
- Especially high productivity when used with Lincolnweld® LC-72 wire
- Actual (Type 3.1) certificates for each lot of flux showing chemical composition, particle size and moisture level are available in the certificate center of lincolnelectric.com

## TYPICAL APPLICATIONS

- Semiautomatic, single and multiple pass submerged arc welding
- General purpose fabrication
- Fillet welds

## RECOMMENDED WIRES

Mild Steel  
 Lincolnweld® L-50®, L-61®, LC-72  
 Low Alloy Steel  
 Lincolnweld® LA-75, LAC-Ni2

## PACKAGING

50 lb (22.7 kg) Bag                      ED027861

## PRODUCT INFORMATION

Basicity Index:     0.6  
 Density:             1.4 g/cm<sup>3</sup>

## FLUX COMPOSITION<sup>(1)</sup>

	%SiO <sub>2</sub>	%MnO	%MgO	%CaF <sub>2</sub>	%Na <sub>2</sub> O	%Al <sub>2</sub> O <sub>3</sub>	%TiO <sub>2</sub>	% Metal Alloys
Lincolnweld® 980™	11	14	2	12	2	47	7	4 max

## AWS TEST RESULTS<sup>(1)</sup>

Flux/Wire Combination	Weld Condition	Yield Strength <sup>(2)</sup> MPa (ksi)	Tensile Strength MPa (ksi)	Elongation (%)	Charpy V-Notch		AWS Classification (A5.17/A5.23)
					J (ft•lbf)	@ °C (°F)	
L-50°	As-welded	430 (63)	540 (78)	31	43 (32)	-29 (-20)	F7A2-EM13K-H8
L-61°	As-welded	430 (63)	530 (77)	31	37 (27)	-29 (-20)	F7A2-EM12K-H8
LC-72	As-welded	450 (65)	540 (78)	28	43 (32)	-29 (-20)	F7A2-EC1-H8
LA-75	As-welded	510 (74)	600 (87)	28	61 (45)	-29 (-20)	F7A2-ENi1K-Ni1-H8
LAC-Ni2	As-welded	540 (79)	630 (91)	25	110 (81)	-29 (-20)	F8A2-ECNi2-Ni2-H8

<sup>(1)</sup>See test results disclaimer <sup>(2)</sup>Measured with 0.2% offset. NOTE: For the most up-to-date AWS certificates of conformance please visit [www.lincolnelectric.com](http://www.lincolnelectric.com)

# LINCOLNWELD® WTX™

Special Neutral Flux ■ EN ISO 14174 – S A AB 1

## KEY FEATURES

- Neutral submerged arc welding flux designed to meet the specific requirements of wind tower welding applications
- Recommended for use with Lincolnweld® L-61® electrode on both longitudinal and circumferential seam welds
- Capable of producing weld deposits with impact properties exceeding 27 J (20 ft•lbf) at -62°C (-80°F)
- Smooth bead profile to achieve excellent toe angles, tie-in, and bead appearance on interior and exterior applications
- Actual (Type 3.1) certificates for each lot of flux showing chemical composition, particle size and moisture level are available in the certificate center of [lincolnelectric.com](http://lincolnelectric.com)

## PACKAGING

50 lb (22.7 kg) Plastic Bag	ED032990
2200 lb (998 kg) Foil Lined Bulk Bag	ED033903

## TYPICAL APPLICATIONS

- Wind tower base
- Wind tower door frame

## RECOMMENDED WIRES

Mild Steel  
Lincolnweld® L-61®  
Low Alloy Steel  
Lincolnweld® L-70

## PRODUCT INFORMATION

Basicity Index: 1.4  
Density: 1.2 g/cm<sup>3</sup>

## FLUX COMPOSITION<sup>(1)</sup>

	%SiO <sub>2</sub>	%Mn <sub>x</sub> O <sub>y</sub>	%MgO	%CaF <sub>2</sub>	%NaO	%Al <sub>2</sub> O <sub>3</sub>	%CaO	%ZrO <sub>2</sub>	%FeO	%K <sub>2</sub> O	%TiO <sub>2</sub>
Lincolnweld® WTX™	21	9	23	13	2	25	5	1	2	1	1

## AWS TEST RESULTS<sup>(1)</sup>

Flux/Wire Combination	Weld Condition	Yield Strength <sup>(2)</sup> MPa (ksi)	Tensile Strength MPa (ksi)	Elongation (%)	Charpy V-Notch		AWS Classification (A5.17/A5.23)
					J (ft•lbf)	@ °C (°F)	
L-61	As-welded	430 (63)	540 (78)	31	84 (62)	-62 (-80)	F7A8-EM12K-H8
LA-81	As-welded	500 (73)	610 (88)	25	46 (34)	-40 (-40)	F8A4-EA1-A3-H8
LA-71	As-welded	560 (82)	630 (92)	28	56 (41)	-51 (-60)	F7A6-EM14K-H8
LA-81	As-welded	600 (87)	700 (102)	27	88 (65)	-51 (-60)	F9TA6-EG-H8

<sup>(1)</sup>See test results disclaimer <sup>(2)</sup>Measured with 0.2% offset. NOTE: For the most up-to-date AWS certificates of conformance please visit [www.lincolnelectric.com](http://www.lincolnelectric.com)

# LINCOLNWELD® WTX™-TR

Special Neutral Flux ■ EN ISO 14174 – S A AB 1

## KEY FEATURES

- Neutral submerged arc welding flux designed to meet the specific requirements of two-run welding technique for wind tower welding applications
- Recommended for use with non-specific electrode on both longitudinal and circumferential seam welds
- Capable of producing weld deposits with impact properties exceeding 27 J (20 ft•lbf) at -40°C (-40°F) in two run applications
- Smooth bead profile to achieve excellent toe angles, tie-in, and bead appearance on interior and exterior applications
- Actual (Type 3.1) certificates for each lot of flux showing chemical composition, particle size and moisture level are available in the certificate center of lincolnelectric.com

## PACKAGING

50 lb (22.7 kg) Plastic Bag	ED035463
2200 lb (998 kg) Foil Lined Bulk Bag	ED035845

## RECOMMENDED WIRES

Mild Steel  
Lincolnweld® L-61®

## TYPICAL APPLICATIONS

- Wind tower base
- Wind tower door frame

## PRODUCT INFORMATION

Basicity Index: 1.5  
Density: 1.2 g/cm<sup>3</sup>

## FLUX COMPOSITION<sup>(1)</sup>

	%SiO <sub>2</sub>	%Mn <sub>x</sub> O <sub>y</sub>	%MgO	%CaF <sub>2</sub>	%NaO	%Al <sub>2</sub> O <sub>3</sub>	%CaO	%ZrO <sub>2</sub>	%FeO	%K <sub>2</sub> O	%TiO <sub>2</sub>	% Metal Alloys
Lincolnweld® WTX™-TR	17	18	22	13	2	25	4	2	3	1	3	<5

## AWS TEST RESULTS<sup>(1)</sup>

Flux/Wire Combination	Weld Condition	Yield Strength <sup>(2)</sup> MPa (ksi)	Tensile Strength MPa (ksi)	Elongation (%)	Charpy V-Notch		AWS Classification (A5.23)
					J (ft•lbf)	@ °C (°F)	
L-61®	As-welded	560 (81)	640 (92)	23	160 (118)	-40 (-40)	F7TA4-EM12K-H8
L-61®	As-welded	500 (81)	640 (85)	28	172 (127)	-40 (-40)	F7TA4-EM12K-H8
L-70	As-welded	540 (78)	630 (91)	29	73 (54)	-40 (-40)	F8TA4-EA1-H8
LA-75	As-welded	500 (73)	620 (89)	25	51 (37)	-18 (0)	F8TA0-ENi1K
L-61®	As-welded	510 (74)	580 (85)	28	81 (60)	-51 (-60)	F7A6-EM12K-H8

<sup>(1)</sup>See test results disclaimer <sup>(2)</sup>Measured with 0.2% offset. NOTE: For the most up-to-date AWS certificates of conformance please visit [www.lincolnelectric.com](http://www.lincolnelectric.com)

# LA490

Special Neutral Flux ■ EN ISO 14174 SA FB 155 AC H5

## KEY FEATURES

- Recommended for use with 9CrMoV-N & 9CrMoV solid wires
- Agglomerated fluoride-basic flux for P91 & P92 modified 9CrMo creep resistant steels
- Composition aids in producing crack resistant welds
- Self releasing slag

## PACKAGING

25 kg (55.1 lb) Sahara ReadyBag™ FXLA490SA-25SRB

## CONFORMANCES

**AWS A5.23M:** F62P0-EB91-B91  
(FLUX-WIRE COMBINATION)

## TYPICAL APPLICATIONS

- Main Steam Piping
- Power Generation Plants
- Oil Refineries

## OPERATING PARAMETERS

AC or DC+; typical 420A, 28V,  
390mm/min (15.4 in/min)

## FLUX COMPOSITION<sup>(1)</sup>

	%SiO <sub>2</sub> + Al <sub>2</sub> O <sub>3</sub>	%CaO + MgO	%CaF <sub>2</sub>	Basicity Index (Boniszewski)
LA490	30	36	27	Approximately 3.0

## AWS TEST RESULTS<sup>(1)</sup>

Flux/Wire Combination	PWHT Condition	Yield Strength <sup>(2)</sup> MPa (ksi)	Tensile Strength MPa (ksi)	Elongation (%)		Charpy V-Notch		AWS Classification (A5.23M)
				4 d	5 d	J (ft•lbf)	@ °C (°F)	
9CrMoV-N	750°-760°/2h	610 (89)	720 (104)	25%	23%	45 (33)	20 (68)	F62P0-EB91-B91

<sup>(1)</sup>See test results disclaimer <sup>(2)</sup>Measured with 0.2% offset.

NOTE: If flux becomes damp, rebake at 300-350 °C (572-662 °F)/1-2 hours to restore to as-packed condition.

NOTE: For the most up-to-date AWS certificates of conformance please visit [www.lincolnelectric.com](http://www.lincolnelectric.com)

# LINCOLNWELD® 761-PIPE™

Flux for Seam Welding of Pipe ▪ EN ISO 14174 – S A MS 1; EN ISO 14174 – S A CS 1

## KEY FEATURES

- Features the chemical composition of 761 with a particle size optimized for seam welding
- Low-melting slag system produces wide flat welds with superior resistance to cracks and pockmarking
- Can handle up to 5 arcs or 5,000 amps
- Actual (Type 3.1) certificates for each lot of flux showing chemical composition, particle size and moisture level are available in the certificate center of lincolnelectric.com

## PACKAGING

50 lb (22.7 kg) Plastic Bag ED032797  
2600 lb (1179 kg) Foil Lined Bulk Bag ED032768

## TYPICAL APPLICATIONS

- Single and multiple arc welding
- Longitudinal seam welding of API grade pipe
- Spiral seam welding of API grade or water pipe

## RECOMMENDED WIRES

Mild Steel  
Lincolnweld® L-61®  
Low Alloy Steel  
Lincolnweld® L-70

## PRODUCT INFORMATION

Basicity Index: 0.8  
Density: 1.2 g/cm<sup>3</sup>

## FLUX COMPOSITION<sup>(1)</sup>

	%SiO <sub>2</sub>	%Mn <sub>2</sub> O <sub>3</sub>	%MgO	%CaF <sub>2</sub>	%NaO	%Al <sub>2</sub> O <sub>3</sub>	%TiO <sub>2</sub>	%FeO	% Metal Alloys
Lincolnweld® 761-Pipe™	45	19	22	5	2	2	2	1	6 max

## AWS TEST RESULTS<sup>(1)</sup>

Flux/Wire Combination	Weld Condition	Yield Strength <sup>(2)</sup> MPa (ksi)	Tensile Strength MPa (ksi)	Elongation (%)	Charpy V-Notch		AWS Classification (A5.17/A5.23)
					J (ft·lbf)	@ °C (°F)	
L-61®	As-welded	490 (70)	580 (85)	28	54 (40)	-29 (-20)	F7A2-EM12K-H4
L-90	As-welded	420 (60)	540 (79)	29	60 (50)	-20 (-20)	F7A2-EL12-H4

<sup>(1)</sup>See test results disclaimer <sup>(2)</sup>Measured with 0.2% offset. NOTE: For the most up-to-date AWS certificates of conformance please visit [www.lincolnelectric.com](http://www.lincolnelectric.com)

# LINCOLNWELD® P223™

Flux for Seam Welding of Pipe ■ EN ISO 14174 – S A AB 1

## KEY FEATURES

- Industry standard for pipe welding on up to X80 grade pipe
- Fast freezing and easily removable slag for excellent bead profile
- Can be used for welding with up to three arcs
- Actual (Type 3.1) certificates for each lot of flux showing chemical composition, particle size and moisture level are available in the certificate center of lincolnelectric.com

## PACKAGING

50 lb (22.7 kg) Plastic Bag ED032764  
 2600 lb (1179 kg) Foil Lined Bulk Bag ED032767

## TYPICAL APPLICATIONS

- Pipe welding up to X80 grade pipe
- Two run welding applications for pipe fabrication
- Multiple pass welding for general construction

## RECOMMENDED WIRES

Mild Steel  
 Lincolnweld® L-56®, L-61®, LA-71, L-53  
 Low Alloy Steel  
 Lincolnweld® L-70, LA-90

## PRODUCT INFORMATION

Basicity Index: 1.5  
 Density: 1.2 g/cm<sup>3</sup>

## FLUX COMPOSITION<sup>(1)</sup>

	%SiO <sub>2</sub>	%MnO	%MgO	%CaF <sub>2</sub>	%NaO	%Al <sub>2</sub> O <sub>3</sub>	%CaO	%TiO <sub>2</sub>	%K <sub>2</sub> O	%FeO	% Metal Alloys
Lincolnweld® P223™	23	4	21	21	2	20	4	2	1	1	3 max

## AWS TEST RESULTS<sup>(1)</sup>

Flux/Wire Combination	Weld Condition	Yield Strength <sup>(2)</sup> MPa (ksi)	Tensile Strength MPa (ksi)	Elongation (%)	Charpy V-Notch		AWS Classification (A5.17/A5.23)
					J (ft•lbf)	@ °C (°F)	
L-56°	As-welded	500 (73)	620 (90)	30	68 (50)	-51 (-60)	F7A6-EH11K-H8
L-56°	Stress-relieved <sup>(3)</sup>	540 (65)	580 (84)	30	66 (49)	-51 (-60)	F7P6-EH11K-H8
L-61°	As-welded	430 (63)	530 (77)	31	126 (93)	-40 (-40)	F7A4-EM12K
LA-71	As-welded	480 (69)	570 (83)	29	94 (69)	-40 (-40)	F7A4-EM14K-H8
LA-71	Stress-relieved <sup>(3)</sup>	410 (60)	540 (78)	32	76 (56)	-51 (-60)	F7P6-EM14K-H8
L-53	As-welded	460 (67)	570 (82)	30	88 (65)	-62 (-80)	F7A8-EH12K-H8
L-70	As-welded	550 (80)	650 (94)	25	53 (39)	-29 (-20)	F8A2-EA1-A2
LA-90	As-welded	630 (91)	720 (105)	25	60 (44)	-18 (0)	F9A0-EA3K-G

<sup>(1)</sup>See test results disclaimer <sup>(2)</sup>Measured with 0.2% offset. <sup>(3)</sup>Stress-relieved for 1 hour at 621°C (1150°F).  
 NOTE: For the most up-to-date AWS certificates of conformance please visit [www.lincolnelectric.com](http://www.lincolnelectric.com)

# LINCOLNWELD® LPX80N™

Flux for Seam Welding of Pipe ▪ EN ISO 14174 - S A AB 1

## KEY FEATURES

- A nitrogen limiting flux designed for seam welding of pipe
- Recommended for longitudinal seam welding on a range of pipe steels
- Less than 5mL/100g of diffusible hydrogen in the weld deposit with both copper coated and non-copper coated (Emergence) welding wire
- Actual (Type 3.1) certificates for each lot of flux showing chemical composition, particle size and moisture level are available in the certificate center of lincolnelectric.com

## PACKAGING

50 lb (22.7 kg) Plastic Bag	ED036786
2600 lb (1179 kg) Foil Lined Bulk Bag	ED036839

## TYPICAL APPLICATIONS

- Single or multiple arc welding
- Longitudinal welding of pipe

## RECOMMENDED WIRES

Mild Steel

Lincolnweld® L-61®, Lincolnweld® Emergence™ 61

Low Alloy Steel

Lincolnweld® L-70, LA-81, Lincolnweld® Emergence™ 70, 74, 81

## PRODUCT INFORMATION

Basicity Index: 1.2

Density: 1.1 g/cm<sup>3</sup>

## FLUX COMPOSITION<sup>(1)</sup>

	%SiO <sub>2</sub>	%MnO	%MgO	%CaF <sub>2</sub>	%NaO	%Al <sub>2</sub> O <sub>3</sub>	%CaO	%ZrO <sub>2</sub>	%FeO	%Fe <sub>2</sub> O <sub>3</sub>	%TiO <sub>2</sub>
Lincolnweld® LPX80N™	23	12	17	12	4	24	5	2	2	3	1

## AWS TEST RESULTS<sup>(1)</sup>

Flux/Wire Combination	Weld Condition	Yield Strength <sup>(2)</sup> MPa (ksi)	Tensile Strength MPa (ksi)	Elongation (%)	Charpy V-Notch		AWS Classification
					J (ft•lbf)	@ °C (°F)	
L-61®	As-welded	540 (78)	630 (92)	28	35 (26)	-29 (-20)	F6TA2-EM12K-H8
L-70	As-welded	510 (74)	620 (90)	26	61 (45)	-29 (-20)	F8TA2-EA1-H8
LA-81	As-welded	560 (82)	650 (94)	25	50 (37)	-51 (-60)	F8TA6-EA2TiB-H8

<sup>(1)</sup>See test results disclaimer <sup>(2)</sup>Measured with 0.2% offset.

NOTE: For the most up-to-date AWS certificates of conformance please visit [www.lincolnelectric.com](http://www.lincolnelectric.com)

# LINCOLNWELD® SPX80™

Flux for Seam Welding of Pipe ■ EN ISO 14174 - S A AB 1

## KEY FEATURES

- Designed to meet the specific requirements of spiral pipe seam welding of up to API X80 grade pipe
- High speed welding capability for increased productivity
- Capable of producing weld deposits with impact properties exceeding 27 J (20 ft•lbf) at -51°C (-60°F) with Lincolnweld® LA-81
- Smooth bead profile achieves optimal appearance on both inner and outer diameter welds
- Self-peeling slag allows for clean and easy slag removal for reliable non-destructive testing results
- Actual (Type 3.1) certificates for each lot of flux showing chemical composition, particle size and moisture level are available in the certificate center of lincolnelectric.com

## TYPICAL APPLICATIONS

- Spiral pipe mills
- Weld up to API X80 pipe
- Two run welding applications

## RECOMMENDED WIRES

Mild Steel  
Lincolnweld® L-61®

Low Alloy Steel  
Lincolnweld® L-70, LA-81, LA-90

## PACKAGING

50 lb (22.7 kg) Plastic Bag ED032960  
2600 lb (1179 kg) Foil Lined Bulk Bag ED033319

## PRODUCT INFORMATION

Basicity Index: 1.2  
Density: 1.2 g/cm<sup>3</sup>

## FLUX COMPOSITION<sup>(1)</sup>

	%SiO <sub>2</sub>	%MnO	%MgO	%CaF <sub>2</sub>	%NaO	%Al <sub>2</sub> O <sub>3</sub>	%CaO	%ZrO <sub>2</sub>	%FeO	%TiO <sub>2</sub>
Lincolnweld® SPX80™	21	9	21	14	1	28	3	2	1	1

## AWS TEST RESULTS<sup>(1)</sup> - TWO RUN

Flux/Wire Combination	Steel Type	Weld Condition	Yield Strength <sup>(2)</sup> MPa (ksi)	Tensile Strength MPa (ksi)	Elongation (%)	Charpy V-Notch		AWS Classification (A5.17/A5.23)
						J (ft•lbf)	@ °C (°F)	
L-61®	A131	As-welded	400 (67)	600 (86)	30	45 (33)	-18 (0)	F7TA0-EM12K-H8
L-70	X65	As-welded	560 (82)	650 (94)	26	88 (65)	-40 (-40)	F8TA4G-EA1-H8
LA-90	X80	As-welded	570 (83)	690 (100)	27	72 (53)	-40 (-40)	F9TA4G-EA3K-H8
LA-75	A131	As-welded	470 (68)	640 (93)	27	52 (38)	-18 (0)	F7TA0-ENi1K
LA-81	X80	As-welded	550 (80)	640 (93)	28	40 (29)	-40 (-40)	F9TA6G-EA2TiB

<sup>(1)</sup>See test results disclaimer <sup>(2)</sup>Measured with 0.2% offset. NOTE: For the most up-to-date AWS certificates of conformance please visit [www.lincolnelectric.com](http://www.lincolnelectric.com)



# LINCOLNWELD® SPX80N™

Flux for Seam Welding of Pipe ▪ EN ISO 14174 - S A AB 1

## KEY FEATURES

- A nitrogen limiting flux designed for spiral pipe welding
- Designed to meet the specific requirements of spiral pipe seam welding of up to API X80 grade pipe.
- High speed welding capability for increased productivity
- Smooth bead profile achieves optimal appearance on both inner and outer diameter welds
- Self-peeling slag allows for clean and easy slag removal for reliable non-destructive testing results
- Actual (Type 3.1) certificates for each lot of flux showing chemical composition, particle size and moisture level are available in the certificate center of [lincolnelectric.com](http://lincolnelectric.com)

## PACKAGING

50 lb (22.7 kg) Plastic Bag	ED032960
2600 lb (1179 kg) Foil Lined Bulk Bag	ED033319

## TYPICAL APPLICATIONS

- Spiral Pipe Manufacturing
- Weld up to X80 pipe

## RECOMMENDED WIRES

Mild Steel  
Lincolnweld® L-61®

Low Alloy Steel  
Lincolnweld® L-70, LA-81, LA-90

## PRODUCT INFORMATION

Basicity Index: 1.2  
Density: 1.2 g/cm<sup>3</sup>

## FLUX COMPOSITION<sup>(1)</sup>

	%SiO <sub>2</sub>	%MnO	%MgO	%CaF <sub>2</sub>	%NaO	%Al <sub>2</sub> O <sub>3</sub>	%CaO	%ZrO <sub>2</sub>	%FeO	%TiO <sub>2</sub>
Lincolnweld® SPX80N™	19	8	19	8	2	30	7	2	3	1

## AWS TEST RESULTS<sup>(1)</sup> - TWO RUN

Flux/Wire Combination	Steel Type	Weld Condition	Yield Strength <sup>(2)</sup> MPa (ksi)	Tensile Strength MPa (ksi)	Elongation (%)	Charpy V-Notch		AWS Classification (A5.17/A5.23)
						J (ft·lbf)	@ °C (°F)	
L-61®	X70	As-welded	510 (74)	620 (90)	30	57 (42)	-18 (0)	F8TA0G-EM12K
L-70	X70	As-welded	570 (83)	660 (95)	26	76 (56)	-40 (-40)	F9TA4G-EA1
LA-90	X70	As-welded	600 (87)	710 (103)	26	99 (73)	-51 (-60)	F9TA6G-EA3K
LA-81	X70	As-welded	600 (87)	680 (98)	27	148 (109)	-51 (-60)	F9TA6G-EA2TiB

<sup>(1)</sup>See test results disclaimer <sup>(2)</sup>Measured with 0.2% offset. NOTE: For the most up-to-date AWS certificates of conformance please visit [www.lincolnelectric.com](http://www.lincolnelectric.com)

# LINCOLNWELD® 995N™

Flux for Seam Welding of Pipe ▪ EN ISO 14174 – S A AB 1

## KEY FEATURES

- A nitrogen limiting flux designed for seam welding of pipe
- Recommended for automatic single pass welding with up to five arcs
- Produces welds with minimal buildup and good penetration
- Capable of producing Charpy V-Notch test results required for arctic grade service
- Actual (Type 3.1) certificates for each lot of flux showing chemical composition, particle size and moisture level are available in the certificate center of lincolnelectric.com

## PACKAGING

50 lb (22.7 kg) Plastic Bag      ED032831

## TYPICAL APPLICATIONS

- Automatic, single pass welding
- Single or multiple arc welding
- High speed longitudinal seam welding on a range of pipe steels
- One side welding requiring impact properties

## RECOMMENDED WIRES

Mild Steel  
Lincolnweld® L-61®  
Low Alloy Steel  
Lincolnweld® L-70, LA-81, LA-90

## PRODUCT INFORMATION

Basicity Index: 1.3  
Density: 1.0 g/cm<sup>3</sup>

## FLUX COMPOSITION<sup>(1)</sup>

	%SiO <sub>2</sub>	%MnO	%MgO	%CaF <sub>2</sub>	%Na <sub>2</sub> O	%Al <sub>2</sub> O <sub>3</sub>	%CaO	%ZrO <sub>2</sub>	%FeO	%TiO <sub>2</sub>	% Metal Alloys
Lincolnweld® 995N™	19	11	16	14	3	27	5	2	1	1	3 max

## AWS TEST RESULTS<sup>(1)</sup>

Flux/Wire Combination	Weld Condition	Yield Strength <sup>(2)</sup> MPa (ksi)	Tensile Strength MPa (ksi)	Elongation (%)	Charpy V-Notch		AWS Classification (A5.17/A5.23)
					J (ft•lbf)	@ °C (°F)	
L-70	As-welded	510 (74)	610 (88)	24	73 (54)	-29 (-20)	F8A2-EA1-A4
LA-81	As-welded	590 (96)	660 (96)	26	58 (43)	-29 (-20)	F9A2-EG-G-H4
LA-90	As-welded	600 (87)	700 (102)	25	54 (40)	-29 (-20)	F9A2-EA3K-G-H8

<sup>(1)</sup>See test results disclaimer <sup>(2)</sup>Measured with 0.2% offset. NOTE: For the most up-to-date AWS certificates of conformance please visit [www.lincolnelectric.com](http://www.lincolnelectric.com)

# LINCOLNWELD® A-XXX10™

High Performance / Alloy Flux ■ EN ISO 14174 – S A AS 1

## KEY FEATURES

- An alloy flux designed to produce a nominal 1% nickel-bearing weld deposit
- Recommended for use on ASTM A533 Class 1 and A588 weathering steels when combined with Lincolnweld® L-61®
- Actual (Type 3.1) certificates for each lot of flux showing chemical composition, particle size and moisture level are available in the certificate center of lincolnelectric.com

## PACKAGING

50 lb (22.7 kg) Bag

ED027862

## TYPICAL APPLICATIONS

- Welding of A588 weathering steels and ASTM A533-Class 1

## RECOMMENDED WIRES

For Low Alloy  
Lincolnweld® L-61®

## PRODUCT INFORMATION

Basicity Index: 1.0  
Density: 1.4 g/cm<sup>3</sup>

## NOTES

- Since the alloy level in the weld deposit depends upon the arc voltage, and thus the arc length, always maintain a consistent arc voltage. If more flexibility in procedure is necessary, use 960 flux and LA-75 electrode.

## FLUX COMPOSITION<sup>(1)</sup>

	%SiO <sub>2</sub>	%MnO	%MgO	%CaF <sub>2</sub>	%Na <sub>2</sub> O	%Al <sub>2</sub> O <sub>3</sub>	%ZrO <sub>2</sub>	%TiO <sub>2</sub>	% Metal Alloys
Lincolnweld® A-XXX10™	18	5	22	11	2	19	22	1	5 max

## AWS TEST RESULTS<sup>(1)</sup>

Flux/Wire Combination	Weld Condition	Yield Strength <sup>(2)</sup> MPa (ksi)	Tensile Strength MPa (ksi)	Elongation (%)	Charpy V-Notch		AWS Classification (A5.17/A5.23)
					J (ft·lbf)	@ °C (°F)	
L-61®	As-welded	460 (67)	570 (83)	30	85 (63)	-40 (-40)	F7A4-EM12K-Ni1-H8

<sup>(1)</sup>See test results disclaimer <sup>(2)</sup>Measured with 0.2% offset. NOTE: For the most up-to-date AWS certificates of conformance please visit [www.lincolnelectric.com](http://www.lincolnelectric.com)

# LINCOLNWELD® MIL800-HPNi™

High Performance / Alloy Flux ■ EN ISO 14174 – S A FB 1

## KEY FEATURES

- When used with Lincolnweld® LA-85 the nickel content will increase from a nominal 1% to a minimum 1%
- Use on high performance steel applications, including HPS70W or HPS100W
- Capable of producing ultra low H<sub>2</sub> diffusible hydrogen levels on HPS steels
- Actual (Type 3.1) certificates for each lot of flux showing chemical composition, particle size and moisture level are available in the certificate center of lincolnelectric.com

## PACKAGING

50 lb (22.7 kg)

Hermetically Sealed Foil Bag

ED035893

## TYPICAL APPLICATIONS

- Bridge fabrication with HPS70W steel, when used with LA-85 wire
- Single or multiple wire arc welding
- Butt and fillet welds on low alloy steels

## RECOMMENDED WIRES

Low Alloy Steel

Lincolnweld® LA-75, LA-85, LA-100

## PRODUCT INFORMATION

Basicity Index: 3.1

Density: 1.3 g/cm<sup>3</sup>

## FLUX COMPOSITION<sup>(1)</sup>

	%SiO <sub>2</sub>	%MgO	%CaF <sub>2</sub>	%Na <sub>2</sub> O	%Al <sub>2</sub> O <sub>3</sub>	%CaO	%TiO <sub>2</sub>	%K <sub>2</sub> O	%FeO	% Metal Alloys
Lincolnweld® MIL800-HPNi™	13	34	22	1	16	8	2	1	1	3 max

## AWS TEST RESULTS<sup>(1)</sup>

Flux/Wire Combination	Weld Condition	Yield Strength <sup>(2)</sup> MPa (ksi)	Tensile Strength MPa (ksi)	Elongation (%)	Charpy V-Notch		AWS Classification (A5.17/A5.23)
					J (ft·lbf)	@ °C (°F)	
LA-75	As-welded	560 (81)	640 (93)	28	145 (107)	-51 (-60)	F8A6-ENi1K-G-H2
LA-85	As-welded	600 (88)	690 (100)	25	143 (105)	-40 (-40)	F9A4-ENi5-G-H2
LA-100	As-welded	800 (116)	850 (123)	23	91 (67)	-40 (-40)	F11A4-EM2-G-H2

<sup>(1)</sup>See test results disclaimer <sup>(2)</sup>Measured with 0.2% offset. NOTE: For the most up-to-date AWS certificates of conformance please visit [www.lincolnelectric.com](http://www.lincolnelectric.com)

# LINCOLNWELD® L-50®

Mild Steel Solid Electrode ■ AWS EM13K

## KEY FEATURES

- A low carbon, medium manganese, medium silicon wire
- Pair it with Lincolnweld® 980™ flux for the best flux/wire combination when semiautomatic submerged arc welding
- Actual (Type 3.1) certificates for each lot of wire showing chemical composition are available in the certificate center of [lincolnelectric.com](http://lincolnelectric.com)

## CONFORMANCES

AWS A5: EA3K

ISO: SU25

## RECOMMENDED FLUXES

Lincolnweld® 760®, 761®, 780®, 781®, 860®, 865™, 880M®, 882™, 888™, 8500™, 960®, 980™, P223™

## DIAMETERS / PACKAGING

Diameter in (mm)	60 lb (27.2 kg) Coil	600 lb (272 kg) Speed Feed® Drum	1000 lb (453 kg) Speed Feed® Drum	1000 lb (453 kg) Accu-Trak® Drum	2200 lb (998 kg) Speed Feed® Stem
1/16 (1.6)	ED011317	ED011316		ED029083	
5/64 (2.0)	ED011335		ED011334		
3/32 (2.4)	ED011328		ED011327		
1/8 (3.2)	ED011323		ED011322		ED033481
5/32 (4.0)	ED011332		ED011331		ED032997
3/16 (4.8)	ED015469		ED015352		

## WIRE COMPOSITION<sup>(1)</sup> - As Required per AWS A5.17

	%C	%Mn	%Si	%S	%P	%Cu
Lincolnweld® L-50®	0.06-0.16	0.90-1.40	0.35-0.75	0.030	0.030	0.35

<sup>(1)</sup>Single values are maximums.

# LINCOLNWELD® L-56®

Mild Steel Solid Electrode ■ AWS EH11K

## KEY FEATURES

- A low carbon, high manganese, very high silicon wire
- Can be used with Lincolnweld® 800 series fluxes for welds requiring 480 MPa (70 ksi) tensile strength in stress relieved conditions
- Actual (Type 3.1) certificates for each lot of wire showing chemical composition are available in the certificate center of lincolnelectric.com

## CONFORMANCES

**AWS A5:** ER70S-6  
**ISO:** SU31

## RECOMMENDED FLUXES

Lincolnweld® 860®, 880M®, 882™, 888™, 8500™, P223™

## DIAMETERS / PACKAGING

Diameter in (mm)	60 lb (27.2 kg) Coil	Accu-Trak® Drum		1000 lb (453 kg) Speed Feed® Reel	1000 lb (453 kg) Speed Feed® Drum	2200 lb (998 kg) Speed Feed® Stem
		500 lb (227 kg)	1000 lb (453 kg)			
1/16 (1.6)	ED011666	ED029225	ED029085	EDS01631	ED030425 ED030426 ED028264	ED032998 ED032999
5/64 (2.0)	ED011678					
3/32 (2.4)	ED011674					
1/8 (3.2)	ED011671					
5/32 (4.0)	EDS11677					
3/16 (4.8)	EDS01107					

## WIRE COMPOSITION<sup>(1)</sup> - As Required per AWS A5.17

	%C	%Mn	%Si	%S	%P	%Cu
Lincolnweld® L-56®	0.06-0.15	1.40-1.85	0.80-1.15	0.030	0.030	0.35

<sup>(1)</sup>Single values are maximums.

# LINCOLNWELD® L-60

Mild Steel Solid Electrode ■ AWS EL12

## KEY FEATURES

- A low carbon, low manganese, low silicon general purpose electrode
- Provides the lowest hardness and is best suited for use with the Lincolnweld® 700 series of active fluxes
- Actual (Type 3.1) certificates for each lot of wire showing chemical composition are available in the certificate center of [lincolnelectric.com](http://lincolnelectric.com)

## CONFORMANCES

AWS A5: EL12  
ISO: S1

## RECOMMENDED FLUXES

Lincolnweld® 760®, 761®, 780®, 781™, 860®, 882™

## DIAMETERS / PACKAGING

Diameter in. (mm)	60 lb (27.2 kg) Coil	600 lb (272 kg) Speed Feed® Drum	1000 lb (453 kg) Speed Feed® Drum
5/64 (2.0)	ED011762	EDS11760	ED011761
3/32 (2.4)	ED011752		ED011751
1/8 (3.2)	ED011743	EDS11741	ED011742
5/32 (4.0)	ED011758		ED011757
3/16 (4.8)	ED011749		ED011748

## WIRE COMPOSITION<sup>(1)</sup> - As Required per AWS A5.17

	%C	%Mn	%Si	%S	%P	%Cu
Lincolnweld® L-60	0.04-0.14	0.25-0.60	0.10	0.030	0.030	0.35

<sup>(1)</sup>Single values are maximums.

# LINCOLNWELD® L-61®

Mild Steel Solid Electrode ■ AWS EM12K



## KEY FEATURES

- Industry standard for submerged arc welding applications
- A low carbon, medium manganese, low silicon general purpose submerged arc electrode
- A good choice for a wide range of applications with single or multiple pass subarc welding
- Actual (Type 3.1) certificates for each lot of wire showing chemical composition are available in the certificate center of [lincolnelectric.com](http://lincolnelectric.com)

## CONFORMANCES

**AWS A5:** EM12K  
**ISO:** S2Si

## RECOMMENDED FLUXES

Lincolnweld® 760®, 761®, 780®, 781™, 860®, 865™, 882™, 888™, 761-Pipe™, P223™, 960®, 980™, WTX™, AXXX-10™, 995N™, SPX80™

## DIAMETERS / PACKAGING

Diameter in. (mm)	60 lb (27.2 kg) Coil	250 lb (113 kg) Speed Feed® SlimReel™	300 lb (136 kg) Speed Feed® Reel	300 lb (136 kg) Speed Feed® Drum
1/16 (1.6)	ED011803			
5/64 (2.0)	ED011825, ED030756*			
3/32 (2.4)	ED011815, ED033875*	ED033074		
1/8 (3.2)	ED011807, ED033876*	ED033075		
5/32 (4.0)	ED011821, ED033877*, ED032097**	ED033076	ED030412	ED030628
3/16 (4.8)	ED011812, ED034055*			
Diameter in. (mm)	600 lb (272 kg) Speed Feed® Drum	750 lb (340 kg) Speed Feed® Reel	1000 lb (453 kg) Speed Feed® Drum	2200 lb (998 kg) Speed Feed® Stem
1/16 (1.6)		ED011826	ED011824	
5/64 (2.0)	EDS11823	EDS11817	ED011814, ED034043*	
3/32 (2.4)	EDS11813	EDS11809	ED011806, ED034044*	ED032973
1/8 (3.2)	EDS11805	ED030012	ED011820, ED034045*, ED030703**	ED032972
5/32 (4.0)	EDS11819		ED011811	ED032994
3/16 (4.8)				

\*Buy America Product \*\*Tested Material

## WIRE COMPOSITION<sup>(1)</sup> - As Required per AWS A5.17

	%C	%Mn	%Si	%S	%P	%Cu
Lincolnweld® L-61®	0.05-0.15	0.80-1.25	0.10-0.35	0.030	0.030	0.35

<sup>(1)</sup>Single values are maximums.



# LINCOLNWELD® L-S3

Mild Steel Solid Electrode ■ AWS EH12K

## KEY FEATURES

- A low carbon, high manganese, medium silicon electrode designed for use with the Lincolnweld® 800 series of neutral fluxes
- Capable of producing weld deposits with impact properties exceeding 27 J (20 ft•lbf) at -62°C (-80°F) when used with Lincolnweld® 888™, 8500™, and MIL800-H™ neutral fluxes
- Actual (Type 3.1) certificates for each lot of wire showing chemical composition are available in the certificate center of lincolnelectric.com

## CONFORMANCES

AWS A5: EH12K

ISO: S3Si

## RECOMMENDED FLUXES

Lincolnweld® 860®, 880M®, 882™, 888™, 8500™, MIL800-H™, P223™

## DIAMETERS / PACKAGING

Diameter in (mm)	60 lb (27.2 kg) Coil
3/32 (2.4)	ED028538
1/8 (3.2)	ED016767
5/32 (4.0)	ED016248

## WIRE COMPOSITION<sup>(1)</sup> - As Required per AWS A5.17

	%C	%Mn	%Si	%S	%P	%Cu
Lincolnweld® L-S3	0.06-0.15	1.50-2.0	0.25-0.65	0.025	0.025	0.35

<sup>(1)</sup>Single values are maximums.

# LINCOLNWELD® LA-71

Mild Steel Solid Electrode ■ AWS EM14K

## KEY FEATURES

- A low carbon, medium manganese, medium silicon electrode containing approximately 0.1% titanium
- Small addition of titanium allows deposits to be stress-relieved with little loss of strength, even with extended stress relief times
- Widely used with neutral basic fluxes in both as-welded and post-weld heat treated conditions
- Actual (Type 3.1) certificates for each lot of wire showing chemical composition are available in the certificate center of lincolnelectric.com

## CONFORMANCES

AWS A5: EM14K

ISO: SU24

## RECOMMENDED FLUXES

Lincolnweld® 860®, 865™, 880M®, 882™, 888™, 8500™, MIL800-H™, 960®, P223™

## DIAMETERS / PACKAGING

Diameter in (mm)	60 lb (27.2 kg) Coil	1000 lb (453 kg) Speed Feed® Drum
3/32 (2.4)	ED011052	
1/8 (3.2)	ED011051	EDS30781
5/32 (4.0)	ED011053	EDS30782

## WIRE COMPOSITION<sup>(1)</sup> - As Required per AWS A5.17

	%C	%Mn	%Si	%Ti	%S	%P	%Cu
Lincolnweld® LA-71	0.06-0.19	0.90-1.40	0.35-0.75	0.03-0.17	0.025	0.025	0.35

<sup>(1)</sup>Single values are maximums.

# LINCOLNWELD® AK-10™

Low Alloy Solid Electrode ▪ AWS EG

## KEY FEATURES

- Capable of producing welds with 690 MPa (100 ksi) tensile strength
- Suitable for use where consumables with less than 1% Ni are required
- Actual (Type 3.1) certificates for each lot of wire showing chemical composition are available in the certificate center of [lincolnelectric.com](http://lincolnelectric.com)
- Batch Managed Inventory

## RECOMMENDED FLUXES

Lincolnweld® 812-SRC™

## CONFORMANCES

AWS A5.23: EG

## TYPICAL APPLICATIONS

- NACE applications
- Oil tools
- Riser systems
- High-strength pipe

## DIAMETERS / PACKAGING

Diameters in (mm)	60 lb (27.2kg) Coil
5/64 (2.0)	ED034904
3/32 (2.4)	ED034905
1/8 (3.2)	ED034906
5/32 (4.0)	ED034907

## WIRE COMPOSITION - As required per AWS A5.23

	%C	%Mn	%Si	%Ni	%Mo	%Cr	%S	%P	%V	%Al	%Cu
Lincolnweld® AK-10™	0.10	1.55	0.57	0.88	0.48	0.27	< 0.005	0.01	<0.003	0.004	0.09

# LINCOLNWELD® L-70

Low Alloy Solid Electrode ■ AWS EA1

## KEY FEATURES

- A low carbon, medium manganese, low silicon, 1/2% molybdenum wire used for single or multiple pass welds
- A standard choice for pipe fabrication and other limited pass applications
- Actual (Type 3.1) certificates for each lot of wire showing chemical composition are available in the certificate center of lincolnelectric.com

## CONFORMANCES

AWS A5: EA1  
ISO: S2Mo

## RECOMMENDED FLUXES

Lincolnweld® 761®, 781™, 860®, 882™, 888™, 995N™, 761-Pipe™, P223™, SPX80™

## DIAMETERS / PACKAGING

Diameter in (mm)	60 lb (27.2 kg) Coil	1000 lb (453 kg) Speed Feed® Drum	2200 lb (998 kg) Speed Feed® Stem
5/64 (2.0)	ED012054		
1/8 (3.2)	ED012051	ED021192	ED032971
5/32 (4.0)	ED012053	ED021193	ED032970
3/16 (4.8)	ED012052	EDS21194	ED032996

## WIRE COMPOSITION<sup>(1)</sup> - As Required per AWS A5.23

	%C	%Mn	%Si	%Mo	%S	%P	%Cu
Lincolnweld® L-70	0.05-0.15	0.65-1.00	0.20	0.45-0.65	0.025	0.025	0.35

<sup>(1)</sup>Single values are maximums.

# LINCOLNWELD® LA-75

Low Alloy Solid Electrode ■ AWS ENi1K



## KEY FEATURES

- A low carbon, medium manganese, high silicon, nickel-bearing electrode designed for use with Lincolnweld® neutral fluxes
- Suitable for use in applications requiring less than 1% Ni wire composition
- Actual (Type 3.1) certificates for each lot of wire showing chemical composition are available in the certificate center of lincolnelectric.com

## CONFORMANCES

AWS A5: ENi1K  
ISO: SUN21

## RECOMMENDED FLUXES

Lincolnweld® 860®, 865™, 880™, 880M®, 882™, 888™, MIL800-H™, MIL800-HPNi™, 960®, 980™

## DIAMETERS / PACKAGING

Diameter in (mm)	60 lb (27.2 kg) Coil	1000 lb (453 kg) Speed Feed® Drum
5/64 (2.0)	ED011066, ED034196*	
3/32 (2.4)	ED011064, ED033878*	ED027225, ED034046*
1/8 (3.2)	ED011062, ED033879*	ED033293
5/32 (4.0)	ED011065, ED033880*	ED027224, ED034048*

\*Buy America Product

## WIRE COMPOSITION<sup>(1)</sup> - As Required per AWS A5.23

	%C	%Mn	%Si	%Ni	%S	%P	%Cu
Lincolnweld® LA-75	0.12	0.80-1.40	0.40-0.80	0.75-1.25	0.020	0.020	0.35

<sup>(1)</sup>Single values are maximums.

# LINCOLNWELD® LA-81

Low Alloy Solid Electrode ▪ AWS EA2TiB

## KEY FEATURES

- A low carbon, medium manganese, low silicon, 1/2% molybdenum wire containing small additions of titanium and boron for improved fracture toughness
- Generally used in two run applications for arctic grade line pipe
- It can be used to weld up to API X90 grade pipe
- Actual (Type 3.1) certificates for each lot of wire showing chemical composition are available in the certificate center of [lincolnelectric.com](http://lincolnelectric.com)

## CONFORMANCES

AWS A5: EA2TiB

ISO: SZ

## RECOMMENDED FLUXES

Lincolnweld® 995N™, SPX80™

## DIAMETERS / PACKAGING

Diameter in (mm)	60 lb (27.2 kg) Coil	1000 lb (453 kg) Speed Feed® Drum	2200 lb (998 kg) Speed Feed® Stem
1/8 (3.2)	ED023163	EDS31060	ED032993
5/32 (4.0)			ED032992
3/16 (4.8)			ED032995

## WIRE COMPOSITION<sup>(1)</sup> - As Required per AWS A5.23

	%C	%Mn	%Si	%S	%P	%Mo	Total %Cu	%Ti	%B
Lincolnweld® LA-81 <sup>(1)</sup>	0.06	1.04	0.31	0.006	0.008	0.53	0.12	0.06	0.011

<sup>(1)</sup>Single values are maximums.

# LINCOLNWELD® LA-84

Low Alloy Solid Electrode ■ AWS EF3

## KEY FEATURES

- A nickel-bearing electrode with 1/2% molybdenum
- Can be used for higher strength weldments where impact properties exceeding 27 J (20 ft•lbf) at -62°C (-80°F) are required
- Suitable for use where consumables with less than 1% Ni are required
- Actual (Type 3.1) certificates for each lot of wire showing chemical composition are available in the certificate center of lincolnelectric.com

## CONFORMANCES

AWS A5: EF3

ISO: S3Ni1Mo

## RECOMMENDED FLUXES

Lincolnweld® 860®, 880M®, 882™, 888™, P223™, MIL800-H™, MIL800-HPNi™

## DIAMETERS / PACKAGING

Diameter in (mm)	60 lb (27.2 kg) Coil	1000 lb (453 kg) Speed Feed® Drum
5/64 (2.0)	ED034211	
3/32 (2.4)	ED031871	ED031872
1/8 (3.2)	ED033323	
5/32 (4.0)	ED034212	ED033727

## WIRE COMPOSITION<sup>(1)</sup> - As Required per AWS A5.23

	%C	%Mn	%Si	%Ni	%Mo	%S	%P	%Cu
Lincolnweld® LA-84	0.10-0.18	1.75-2.20	0.2	0.80-1.0	0.45-0.60	0.010-0.020	0.010-0.020	0.05-0.15

<sup>(1)</sup>Single values are maximums.

# LINCOLNWELD® LA-85

Low Alloy Solid Electrode ■ AWS ENi5



## KEY FEATURES

- A nickel-bearing wire with 0.2% molybdenum designed for use on weathering steels
- Capable of producing weld deposits with 480-550 MPa (70-80 ksi) tensile strength in the as-welded and stress-relieved conditions
- Actual (Type 3.1) certificates for each lot of wire showing chemical composition are available in the certificate center of [lincolnelectric.com](http://lincolnelectric.com)

## CONFORMANCES

AWS A5: ENi5

ISO: SZ

## RECOMMENDED FLUXES

Lincolnweld® 860®, 880M®, 882™, 888™, 8500™, MIL800-H™, MIL800-HPNi™, 960®

## DIAMETERS / PACKAGING

Diameter in (mm)	60 lb (27.2 kg) Coil	1000 lb (453 kg) Speed Feed® Drum
3/32 (2.4)	ED023166, ED034426*	ED029965
1/8 (3.2)	ED023167	
5/32 (4.0)	ED023168, ED034427*	ED033273
3/16 (4.8)	ED023169, ED035579*	

\*Buy America Product

## WIRE COMPOSITION<sup>(1)</sup> - As Required per AWS A5.23

	%C	%Mn	%Si	%Ni	%Mo	%S	%P	%Cu
Lincolnweld® LA-85	0.12	1.20 - 1.60	0.05 - 0.30	0.75 - 1.25	0.10 - 0.30	0.025	0.020	0.35

<sup>(1)</sup>Single values are maximums.

# LINCOLNWELD® LA-90

Low Alloy Solid Electrode ▪ AWS EA3K

## KEY FEATURES

- A low carbon, high manganese, high silicon, 1/2% molybdenum special purpose wire
- Recommended for seam welding of pipe and for the general welding of high strength plate
- Actual (Type 3.1) certificates for each lot of wire showing chemical composition are available in the certificate center of lincolnelectric.com

## CONFORMANCES

AWS A5: EA3K

ISO: SZ

## RECOMMENDED FLUXES

Lincolnweld® 880™, 880M®, 888™, 8500™, MIL800-H™, 995N™, P223™, SPX80™

## DIAMETERS / PACKAGING

Diameter in (mm)	60 lb (27.2 kg) Coil	750 lb (340 kg) Speed Feed® Reel	1000 lb (453 kg) Speed Feed® Drum
1/16 (1.6)	ED013999		
5/64 (2.0)	ED011086		
3/32 (2.4)	ED011084		
1/8 (3.2)	EDS11083		
5/32 (4.0)	EDS11085	EDS01154	EDS01152

## WIRE COMPOSITION<sup>(1)</sup> - As Required per AWS A5.23

	%C	%Mn	%Si	%Mo	%S	%P	%Cu
Lincolnweld® LA-90	0.05-0.15	1.60-2.10	0.50-0.80	0.40-0.60	0.025	0.025	0.35

<sup>(1)</sup>Single values are maximums.

# LINCOLNWELD® LA-92

Low Alloy Solid Electrode ■ AWS EB2R

## KEY FEATURES

- Designed for welding 1 1/4% chromium, 1/2% molybdenum steels in high temperature service applications such as pressure vessels or piping
- The AWS R designator denotes ultra low residuals which will result in a low Bruscato factor (X-factor)
- Actual (Type 3.1) certificates for each lot of wire showing chemical composition are available in the certificate center of [lincolnelectric.com](http://lincolnelectric.com)

## CONFORMANCES

AWS A5: EB2R  
ISO: S S CrMo1

## RECOMMENDED FLUXES

Lincolnweld® 880M®, 882™, MIL800-H™, 960®

## DIAMETERS / PACKAGING

Diameter in. (mm)	60 lb (27.2 kg) Coil
3/32 (2.4)	EDS30783
1/8 (3.2)	EDS26960
5/32 (4.0)	EDS26961

## WIRE COMPOSITION<sup>(1)</sup> - As Required per AWS A5.23

	%C	%Mn	%Si	%Cr	%Mo	%S	%P	%Cu
Lincolnweld® LA-92	0.07-0.15	0.45-1.00	0.05-0.30	1.00-1.75	0.45-0.65	0.025	0.025	0.35

<sup>(1)</sup>Single values are maximums.



# LINCOLNWELD® LA-93

Low Alloy Solid Electrode ■ AWS EB3R

## KEY FEATURES

- Designed for high temperature applications such as pressure vessels and piping for 2 1/4% chromium, 1% molybdenum steels
- The AWS R designator denotes ultra low residuals which will result in a low Bruscato factor (X-factor)
- Actual (Type 3.1) certificates for each lot of wire showing chemical composition are available in the certificate center of lincolnelectric.com

## CONFORMANCES

**AWS A5:** EB3R  
**ISO:** S S CrMo2

## RECOMMENDED FLUXES

Lincolnweld® 880M®, 882™, MIL800-H™, 960®

## DIAMETERS / PACKAGING

Diameter in (mm)	60 lb (27.2 kg) Coil	1000 lb (453 kg) Speed Feed® Drum
3/32 (2.4)	EDS30784	ED032185
1/8 (3.2)	EDS26962	
5/32 (4.0)	EDS26963	

## WIRE COMPOSITION<sup>(1)</sup> - As Required per AWS A5.23

	%C	%Mn	%Si	%Cr
Lincolnweld® LA-93	0.05 - 0.15	0.40 - 0.80	0.05 - 0.30	2.25 - 3.00
	%Mo	%S	%P	%Cu
Lincolnweld® LA-93	0.90 - 1.10	0.025	0.025	0.35

<sup>(1)</sup>Single values are maximums.

# LINCOLNWELD® LA-100

Low Alloy Solid Electrode ■ AWS EM2 & ER100S-G & ER110S-G

## KEY FEATURES

- A low carbon, high manganese wire with nickel and molybdenum designed to weld high strength steels such as HY-80 and HSLA-80
- Delivers yield strength greater than 690 MPa (100 ksi)
- Low H<sub>2</sub> hydrogen levels can be achieved when used with MIL800-H™ flux
- Actual (Type 3.1) certificates for each lot of wire showing chemical composition are available in the certificate center of [lincolnelectric.com](http://lincolnelectric.com)

## CONFORMANCES

AWS A5: EM2

ISO: SZ

## RECOMMENDED FLUXES

Lincolnweld® 880™, 880M®, 888™, MIL800-H™, MIL800-HPNi™, 960®

## DIAMETERS / PACKAGING

Diameter in (mm)	60 lb (27.2 kg) Coil
1/16 (1.6)	ED010996
5/64 (2.0)	ED011002
3/32 (2.4)	ED010999
1/8 (3.2)	ED010998
5/32 (4.0)	EDS11001

## WIRE COMPOSITION<sup>(1)</sup> - As Required per AWS A5.23

	%C	%Mn	%Si	%Cr	%Ni	%Mo	%Ti
Lincolnweld® LA-100	0.10	1.25-1.80	0.20-0.60	0.30	1.40-2.10	0.25-0.55	0.10
	%Zr	%Al	%V	%S	%P	%Cu	
Lincolnweld® LA-100	0.10	0.10	0.05	0.015	0.010	0.25	

<sup>(1)</sup>Single values are maximums.

# TECHALLOY 4130

Low Alloy Steel

## KEY FEATURES

- High strength, low alloy
- Preheat and inter-pass temperature of 400°F (204.4°C) is required

## TYPICAL APPLICATIONS

- Joining steels of similar chemical composition
- Overlays where moderate hardness is required

## WELDING POSITIONS

All

## DIAMETERS / PACKAGING

Diameter in (mm)	SAW 55 lb (25kg) Coil
3/32 (2.4)	SA4130093726
1/8 (3.2)	SA4130125726

## WIRE COMPOSITION<sup>(1)</sup>

	%C	%Mn	%Si	%Fe	%Cr	%Mo	%Ni	%V
Typical Results <sup>(3)</sup>	0.31	0.52	0.28	Balance	0.93	0.20	-	-

## MECHANICAL PROPERTIES<sup>(4)</sup>

	Yield Strength <sup>(2)</sup> MPa (ksi)	Tensile Strength MPa (ksi)	Elongation %
Typical Results <sup>(3)</sup>	900 (130)	1,000 (145)	11

## TYPICAL OPERATING PROCEDURES

Process	Diameter in (mm)	Voltage (volts)	Amperage	Gas
SAW	3/32 (2.4)	28	400	N/A
	1/8 (3.2)	28	450	
	5/32 (4.0)	28	500	

<sup>(1)</sup>Typical deposit composition. <sup>(2)</sup>Measured with 0.2% offset. <sup>(3)</sup>See test results disclaimer. <sup>(4)</sup>Quenched from 1,550 F (843 C) in oil and tempered at 1,050 F (565 C). Safety Data Sheets (SDS) are available on our website at [www.lincolnelectric.com](http://www.lincolnelectric.com)

# LINCOLNWELD® LC-72™

Mild Steel Cored Electrode ▪ AWS EC1

## KEY FEATURES

- A cored wire designed to increase deposition rates 10-30% when used with 980 flux
- Designed to provide optimal bead shape, penetration, and slag removal in semiautomatic submerged arc welding

## CONFORMANCES

AWS A5.17: EC1

## RECOMMENDED FLUXES

Lincolnweld® 980™

## DIAMETERS / PACKAGING

Diameter in (mm)	50 lb (23 kg) Coil	300 lb (136 kg) Speed Feed® Reel	600 lb (272 kg) Speed Feed® Reel	600 lb (272 kg) Speed Feed® Drum
5/64 (2.0)	ED011099		EDS27184	
3/32 (2.4)	ED011098	EDS01186		EDS01187

## WIRE COMPOSITION<sup>(1)</sup> - As Required per AWS A5.23

	%C	%Mn	%Si	%S	%P	%Cu
Lincolnweld® LC-72 <sup>(1)</sup>	0.15	1.8	0.9	0.035	0.035	0.35

<sup>(1)</sup>Single values are maximums.

# LINCOLNWELD® LAC-B2

Low Alloy Cored Electrode ▪ AWS ECB2

## KEY FEATURES

- Designed to weld with either single or tandem arcs using a neutral flux
- A cost-effective choice when welding 1 1/4% chromium, 1/2% molybdenum steels where a low Bruscato factor (X-factor) is not required

## CONFORMANCES

AWS A5.23: ECB2

## RECOMMENDED FLUXES

Lincolnweld® 880™, 880M®

## DIAMETERS / PACKAGING

Diameter in (mm)	50 lb (23 kg) Coil	600 lb (272 kg) Speed Feed® Drum
3/32 (2.4)	ED010954	ED019581
5/32 (4.0)	ED010955	ED019582

# LINCOLNWELD® LAC-Ni2

Low Alloy Cored Electrode ▪ AWS ECNi2

## KEY FEATURES

- A 2% nickel electrode used primarily in weathering steel applications
- When used with 888 flux, it can produce impact properties exceeding 27 J (20 ft·lbf) at -73°C (-100°F)

## CONFORMANCES

AWS A5.23: ECNi2

## RECOMMENDED FLUXES

Lincolnweld® 880™, 880M®, 882™, 888™, 980™

## DIAMETERS / PACKAGING

Diameter in (mm)	50 lb (23 kg) Coil
3/32 (2.4)	ED010986

# LINCOLNWELD® LAC-690

Low Alloy Cored Electrode ■ AWS ECG

## KEY FEATURES

- Combine with Lincolnweld® 888™ flux for H4 diffusible hydrogen weld deposits
- Charpy V-notch test results capable of exceeding 27 J (20 ft·lbf) @ -73°C (-100°F) with Lincolnweld® 888™ flux
- Excellent Tandem, AC and DC Operation
- Clean and easy slag removal minimizes risk of inclusions, even in narrow gap applications

## CONFORMANCES

AWS A5.23: ECG

## RECOMMENDED FLUXES

Lincolnweld® 888™  
Lincolnweld® MIL800-H™

## DIAMETERS / PACKAGING

Diameter in (mm)	50 lb (23 kg) Coil
3/32 (2.4)	ED032958
1/8 (3.2)	ED032959
5/32 (4.0)	ED033302

## WIRE COMPOSITION<sup>(1)</sup>

	%C	%Mn	%Si	%S	%P
Lincolnweld® LAC-690 <sup>(2)</sup>	0.08	1.51	0.36	0.007	0.011
	%Cr	%Ni	%Mo	%Cu	Diffusible Hydrogen (mL/100g weld deposit)
Lincolnweld® LAC-690 <sup>(2)</sup>	0.36	2.59	0.44	0.04	3.6

<sup>(1)</sup>See test results disclaimer <sup>(2)</sup>Limits are for weld metal deposited with a particular flux (Lincolnweld® 888™ flux).

# 9CRMOV-N

Low Alloy Steel ▪ AWS EB91

## KEY FEATURES

- Designed to provide creep strength for high integrity structural service at elevated temperatures
- Superior corrosion resistance with high strength toughness

## CONFORMANCES

AWS 5.23: EB91

## TYPICAL APPLICATIONS

- Main Steam Piping
- Power Generation Plants
- Oil Refineries

## DIAMETERS / PACKAGING

Diameter in (mm)	25kg (55.1 lb) Coil
3/32 (2.4)	SA9CRMOVN-24
1/8 (3.2)	SA9CRMOVN-32

## MECHANICAL PROPERTIES<sup>(1)</sup> – As Required per AWS A5.23

	Yield Strength <sup>(2)</sup> MPa (ksi)	Tensile Strength MPa (ksi)	Elongation %	Charpy V-Notch J (ft-lbf) @20 °C (68 °F)	Hardness HV
<b>Requirements</b> AWS EB91	415 (60) min	620 (90) min	16 min	-	-
<b>Typical Performance<sup>(3)</sup></b> As-Welded	675 (98)	750 (109)	22	220	260

## DEPOSIT COMPOSITION<sup>(1)</sup> – As Required per AWS A5.23

	%C	%Mn	%Si	%S	%P	%Cr	%Ni
<b>Requirements</b> AWS EB91	0.08-0.13	0.40-0.80	0.15-0.50	0.010 max	0.010 max	8.5-9.5	0.4-0.8
<b>Typical Performance<sup>(3)</sup></b>	0.1	0.5	0.25	0.006	0.008	8.7	0.6
	%Mo	%Nb	%V	%N	%Cu	%Al	
<b>Requirements</b> AWS EB91	0.85-1.1	0.03-0.08	0.15-0.25	0.03-0.07	0.10 max	0.04 max	
<b>Typical Performance<sup>(3)</sup></b>	1	0.05	0.2	0.05	0.03	<0.01	

## TYPICAL OPERATING PROCEDURES

Diameter mm (in)	Polarity	Amperage	Voltage	WFS
2.4	DC+	450A	30V	450 mm/min

<sup>(1)</sup> Typical all weld metal <sup>(2)</sup> Measured with 0.2% offset <sup>(3)</sup> See test results disclaimer <sup>(4)</sup> Preferred polarity is listed first.

# LINCOLNWELD® EMERGENCE® 61

Mild Steel Solid Electrode ▪ AWS EM12K

## KEY FEATURES

- Low carbon, medium manganese, low silicon electrode
- Coated with proprietary surface lubricant which is designed to eliminate one source of wire contamination in pipe mill welding applications
- Improved contact tip life when compared to non-copper coated wire alternatives
- Exact wire composition to Lincolnweld® L-61® copper coated wires makes requalification for welding procedures controlled by classification seamless

## CONFORMANCES

AWS A5: EM12K

## RECOMMENDED FLUXES:

995N, 998N, 761, 761-PIPE

## DIAMETERS / PACKAGING

Diameter in (mm)	1000 lb (453 kg) Drum Package
1/8 (3.2)	ED035980
5/32 (4.0)	ED035981

## WIRE COMPOSITION - As Required per AWS A5.23

	%C	%Mn	%Si	%S	%P	%Cu
Lincolnweld® Emergence® 61	0.05-0.15	0.80-1.25	0.10-0.35	0.03	0.03	0.35



# LINCOLNWELD® EMERGENCE® 73

Mild Steel Solid Electrode ▪ AWS EG

## KEY FEATURES

- Low carbon, high manganese, medium silicon electrode
- Coated with proprietary surface lubricant which is designed to eliminate one source of wire contamination in pipe mill welding applications
- Improved contact tip life when compared to non-copper coated wire alternatives
- Exact wire composition to Lincolnweld® LS-3 copper coated wires makes requalification for welding procedures controlled by classification seamless

## CONFORMANCES

AWS A5: EG

## RECOMMENDED FLUXES:

995N, 998N, 761, 761-PIPE

## DIAMETERS / PACKAGING

Diameter in (mm)	1000 lb (453 kg) Drum Package
1/8 (3.2)	ED036348
5/32 (4.0)	ED036349

## WIRE COMPOSITION<sup>(1)</sup> - As Required per AWS A5.23

	%C	%Mn	%Si	%S	%P	%Cu
Lincolnweld® Emergence® 73	0.15	1.59	0.20	0.006	0.007	0.012

<sup>(1)</sup>No AWS limits. Values are typical.

# LINCOLNWELD® EMERGENCE® 70

Low Alloy Solid Electrode ▪ AWS EA1

## KEY FEATURES

- Low carbon, medium manganese, low silicon, 1/2% molybdenum electrode
- Coated with proprietary surface lubricant which is designed to eliminate one source of wire contamination in pipe mill welding applications
- Improved contact tip life when compared to non-copper coated wire alternatives
- Exact wire composition to Lincolnweld® L-70 copper coated wires makes requalification for welding procedures controlled by classification seamless

## CONFORMANCES

AWS A5: EA1

## RECOMMENDED FLUXES:

995N, 998N, 761, 761-PIPE

## DIAMETERS / PACKAGING

Diameter in (mm)	1000 lb (453 kg) Drum Package
1/8 (3.2)	ED035982
5/32 (4.0)	ED035983

## WIRE COMPOSITION - As Required per AWS A5.23

	%C	%Mn	%Si	%Mo	%S	%P	%Cu
Lincolnweld® Emergence® 70	0.05-0.15	0.65-1.00	0.30	0.45-0.65	0.025	0.025	0.35

# LINCOLNWELD® EMERGENCE® 81

Low Alloy Solid Electrode ▪ AWS EA2TiB

## KEY FEATURES

- Low carbon, medium manganese, low silicon, ½% molybdenum electrode containing small additions of titanium and boron for improved fracture toughness
- Coated with proprietary surface lubricant which is designed to eliminate one source of wire contamination in pipe mill welding applications
- Improved contact tip life when compared to non-copper coated wire alternatives
- Exact wire composition to Lincolnweld LA-81 copper coated wires makes requalification for welding procedures controlled by classification seamless

## CONFORMANCES

**AWS A5.23:** EA2TiB

## RECOMMENDED FLUXES:

995N, 998N, 761, 761-PIPE

## DIAMETERS / PACKAGING

Diameter in (mm)	1000 lb (453 kg) Drum Package
1/8 (3.2)	ED036506
5/32 (4.0)	ED036507

## WIRE COMPOSITION - As Required per AWS A5.23

	%C	%Mn	%Si	%Mo	%S	%P	%Cu	%Ti	%B
Lincolnweld® Emergence® 81	0.05 – 0.17	0.95 – 1.35	0.35 max	0.45 – 0.65	0.025 max	0.025 max	0.35 max	0.05 – 0.30	0.005 – 0.030

# LINCOLNWELD® EMERGENCE® 90

Low Alloy Solid Electrode ▪ AWS EA3K

## KEY FEATURES

- Low carbon, high manganese, 1/2% molybdenum electrode
- Coated with proprietary surface lubricant which is designed to eliminate one source of wire contamination in pipe mill welding applications
- Improved contact tip life when compared to non-copper coated wire alternatives
- Exact wire composition to Lincolnweld® LA-90 copper coated wires makes requalification for welding procedures controlled by classification seamless

## CONFORMANCES

AWS A5: EA3K

## RECOMMENDED FLUXES:

995N, 998N, 761, 761-PIPE

## DIAMETERS / PACKAGING

Diameter in (mm)	1000 lb (453 kg) Drum Package
1/8 (3.2)	ED036374
5/32 (4.0)	ED036375

## WIRE COMPOSITION - As Required per AWS A5.23

	%C	%Mn	%Si	%Mo	%S	%P	%Cu
Lincolnweld® Emergence® 90	0.05-0.15	1.60-2.10	0.50-0.80	0.40-0.60	0.025	0.025	0.35



# CONSUMABLES

# STAINLESS

## Stick Electrode

Excalibur® 308/308L-15.....	F-1
Excalibur® 308L-16.....	F-2
Excalibur® 308/308H-16.....	F-3
Excalibur® 308/308L-17.....	F-4
Excalibur® 309/309L-15.....	F-5
Excalibur® 309/309L-16.....	F-6
Excalibur® 309/309L-17.....	F-7
Excalibur® 310-16.....	F-8
Excalibur® 312-16.....	F-9
Excalibur® 316/316L-15.....	F-10
Excalibur® 316/316L-16.....	F-11
Excalibur® 316/316L-17.....	F-12
Excalibur® 320LR-16.....	F-13
Excalibur® 330-16.....	F-14
Excalibur® 347-16.....	F-15
Excalibur® 385-16.....	F-16
Excalibur® 410-16.....	F-17
Excalibur® 410NiMo-16.....	F-18
Excalibur® 630-16.....	F-19
Excalibur® 2209-16.....	F-20
Excalibur® 2594-16.....	F-21
E16.8.2-15.....	F-22
Supermet™ 16.8.2.....	F-23
Thermet™ 22H.....	F-24
Thermet™ 25.35Nb.....	F-25
Thermet™ 35.45.Nb.....	F-26
Thermet™ 800Nb.....	F-27
Thermet™ HP40Nb.....	F-28
Thermet™ HP50WCO.....	F-29
Ultramet® 308LCF.....	F-30
Ultramet® 316LCF.....	F-31
UltraMet B™ 316 NF.....	F-32

## MIG Wire

Blue Max® MIG 307_MOD.....	F-33
Blue Max® MIG 308H.....	F-34
Blue Max® MIG 308LSi.....	F-35
Blue Max® MIG 308L.....	F-37
Blue Max® MIG 308LCF.....	F-38
Blue Max® MIG 309LSi.....	F-39
Blue Max® MIG 309L.....	F-41
Blue Max® MIG 309LMo_MOD.....	F-42
Blue Max® MIG 310.....	F-43
Blue Max® MIG 312.....	F-44
Blue Max® MIG 316L.....	F-45
Blue Max® MIG 316LCF.....	F-46
Blue Max® MIG 316LSi.....	F-47
Blue Max® MIG 317L.....	F-49
Blue Max® MIG 320LR.....	F-50
Blue Max® MIG 330.....	F-51
Blue Max® MIG 347.....	F-52
Blue Max® MIG 385.....	F-53
Blue Max® MIG 409Nb.....	F-54
Blue Max® MIG 410.....	F-55
Blue Max® MIG 410NiMo.....	F-56
Blue Max® MIG 420.....	F-57
Blue Max® MIG 630.....	F-58
Blue Max® MIG 2209.....	F-59
Blue Max® MIG 2594.....	F-60
Lincoln® Red Max® 308LSi.....	F-61
Lincoln® Red Max® 309LSi.....	F-63
Lincoln® Red Max® 316LSi.....	F-65
Lincoln® Red Max® 307_MOD.....	F-67
Murex® 308LSi.....	F-69
Murex® 309LSi.....	F-70
Murex® 316LSi.....	F-71

## CONSUMABLES

# STAINLESS

### *Flux-Cored (FCAW-G) Wire*

UltraCore® 308L.....	F-72
UltraCore® 308L P.....	F-74
UltraCore® 309L.....	F-76
UltraCore® 309L P.....	F-78
UltraCore® FC 316L.....	F-80
UltraCore® 316L P.....	F-82
Supercore™ 308LCF.....	F-84
Supercore™ 316LCF.....	F-85
Supercore™ 347.....	F-86
Supercore™ 2205P.....	F-87
Supercore™ 2507.....	F-89
Supercore™ 2507P.....	F-90
Supercore™ 308HP.....	F-91
Supercore™ 317LP.....	F-92
Supercore™ 16.8.2P.....	F-93
Supercore™ Z100XP.....	F-94

### *Submerged Arc Wire*

Lincolnweld® 308/308L.....	F-95
Lincolnweld® 308/308H.....	F-96
Lincolnweld® 308/308LCF.....	F-97
Lincolnweld® 309 LMo_MOD.....	F-98
Lincolnweld® 309/309L.....	F-99
Lincolnweld® 310.....	F-101
Lincolnweld® 316/316LCF.....	F-102
Lincolnweld® 316/316L.....	F-103
Lincolnweld® 317/317L.....	F-105
Lincolnweld® 320LR.....	F-106
Lincolnweld® 347.....	F-107
Lincolnweld® 385.....	F-108
Lincolnweld® 410NiMo.....	F-109
Lincolnweld® 630.....	F-110
Lincolnweld® 2209.....	F-111
Lincolnweld® 2594.....	F-112
ER16.8.2.....	F-113

### *Submerged Arc Flux*

Lincolnweld® P2000™.....	F-114
Lincolnweld® P2007™.....	F-115
Lincolnweld® ST-100™.....	F-116

### *TIG Cut Length*

Lincoln® ER308/308H.....	F-117
Lincoln® ER308/308L.....	F-118
Lincoln® ER308/308LCF.....	F-119
Lincoln® ER308Si/308LSi.....	F-120
Lincoln® ER309/309L.....	F-122
Lincoln® ER309Si/309LSi.....	F-123
Lincoln® ER310.....	F-125
Lincoln® ER312.....	F-126
Lincoln® ER316/316L.....	F-127
Lincoln® ER316/316LCF.....	F-128
Lincoln® ER316Si/316LSi.....	F-129
Lincoln® ER317/317L.....	F-131
Lincoln® ER320LR.....	F-132
Lincoln® ER347.....	F-133
Lincoln® ER385.....	F-134
Lincoln® ER409Nb.....	F-135
Lincoln® ER410.....	F-136
Lincoln® ER410NiMo.....	F-137
Lincoln® ER630.....	F-138
Lincoln® ER2209.....	F-139
Lincoln® ER2594.....	F-140
ER16.8.2.....	F-141

CONSUMABLES  
**STAINLESS**

*Metal-Cored Wire*

PRIMALLOY™ T-409Ti ..... F-142

PRIMALLOY™ T-439Ti ..... F-143

*Orbital TIG (GTAW) Wire*

Blue Max® Orbital TIG 308/308L ..... F-144

Blue Max® Orbital TIG 309/309L ..... F-145

Blue Max® Orbital TIG 316/316L ..... F-146



# EXCALIBUR® 308/308L-15

Stainless ▪ AWS E308-15, E308L-15

## KEY FEATURES

- Versatile electrode designed to weld several types of austenitic steels
- Q2 Lot® - Certificate showing actual deposit composition and ferrite number (FN) by ferrite scope available online
- Designed with low carbon levels to help eliminate carbide precipitation in high temperature service
- Excellent for all welding positions, including vertical down on pipe

## CONFORMANCES

**AWS A5:** E308-15, E308L-15  
**ABS:** E308-15, E308L-15

## TYPICAL APPLICATIONS

- 304 and 304L stainless steels
- Common austenitic stainless steels referred to as "18-8" steels

## WELDING POSITIONS

All

## DIAMETERS / PACKAGING

Diameter in (mm)	Length in (mm)	8 lb (3.6 kg) Easy Open Can
3/32 (2.4)	12 (300)	ED033087
1/8 (3.2)	12 (300)	ED033088

## MECHANICAL PROPERTIES<sup>(1)</sup> – As Required per AWS A5.4

	Yield Strength <sup>(2)</sup> MPa (ksi)	Tensile Strength MPa (ksi)	Elongation %	Ferrite Number
<b>Requirements</b> AWS E308-15 AWS E308L-15	Not Specified Not Specified	550 (80) min 520 (75) min	35 min 35 min	Not Specified Not Specified
<b>Typical Results<sup>(3)</sup> - As-Welded</b>	455 (66)	625 (91)	44	8 -10

## DEPOSIT COMPOSITION<sup>(1)</sup> – As Required per AWS A5.4

	%C <sup>(4)</sup>	%Cr	%Ni	%Mo	%Mn
<b>Requirements - AWS E308L-15</b>	0.04 max	18.0-21.0	9.0-11.0	0.75 max	0.5-2.5
<b>Typical Results<sup>(3)</sup></b>	≤0.03	≤19.9	9.9-10.2	0.05-0.09	0.7-0.8
	%Si	%P	%S	%Cu	
<b>Requirements - AWS E308L-15</b>	1.00 max	0.04 max	0.03 max	0.75 max	
<b>Typical Results<sup>(3)</sup></b>	0.69-0.73	≤0.02	≤0.01	≤0.08	

## TYPICAL OPERATING PROCEDURES

Polarity	Current (Amps)	
	3/32 in (2.4 mm)	1/8 in (3.2 mm)
DC+	60-70	90-100

<sup>(1)</sup>Typical all weld metal. <sup>(2)</sup>Measured with 0.2% offset. <sup>(3)</sup>See test results disclaimer <sup>(4)</sup>AWS Requirement for E308-15 is 0.08% max. carbon.

IMPORTANT: SPECIAL VENTILATION AND/OR EXHAUST REQUIRED

Fumes from the normal use of some welding products can contain significant quantities of components - such as chromium and manganese - which can lower the 5.0 mg/m<sup>3</sup> maximum exposure guideline for general welding fume.

BEFORE USE, READ AND UNDERSTAND THE SAFETY DATA SHEET (SDS) FOR THIS PRODUCT AND SPECIFIC INFORMATION PRINTED ON THE PRODUCT CONTAINER.

# EXCALIBUR® 308L-16

Stainless ▪ AWS E308L-16

## KEY FEATURES

- Flux coating provides smooth arc transfer in all welding positions, except vertical down
- Versatile electrode designed to weld several types of austenitic stainless steels
- Q2 Lot® - Certificate showing actual deposit composition and ferrite number (FN) by ferrite scope available online

## WELDING POSITIONS

All, except vertical down

## CONFORMANCES

<b>AWS A5:</b>	E308L-16
<b>ABS:</b>	E308L-16
<b>CWB/CSA:</b>	E308L-16

## TYPICAL APPLICATIONS

- Type 302, 304 and 304L stainless steels
- A743 and A744 Type CF-8 cast material

## DIAMETERS / PACKAGING

Diameter in (mm)	Length in (mm)	8 lb (3.6 kg) Easy Open Can	10 lb (4.5 kg) Easy Open Can
3/32 (2.4)	12 (300)	ED033079	
1/8 (3.2)	14 (350)		ED033080
5/32 (4.0)	14 (350)		ED033081
3/16 (4.8)	14 (350)		ED033082

## MECHANICAL PROPERTIES<sup>(1)</sup> – As Required per AWS A5.4

	Yield Strength <sup>(2)</sup> MPa (ksi)	Tensile Strength MPa (ksi)	Elongation %	Ferrite Number
<b>Requirements</b> - AWS E308L-16	Not Specified	520 (75) min	35 min	Not Specified
<b>Typical Results<sup>(3)</sup></b> - As-Welded	370-420 (54-61)	540-595 (78-86)	50-55	8-9

## DEPOSIT COMPOSITION<sup>(1)</sup> – As Required per AWS A5.4

	%C	%Cr	%Ni	%Mo	%Mn
<b>Requirements</b> - AWS E308L-16	0.04 max	18.0-21.0	9.0-11.0	0.75 max.	0.5-2.5
<b>Typical Results<sup>(3)</sup></b>	0.02-0.03	19.5-19.8	9.7-10.3	0.04-0.13	0.6-0.9
	%Si	%P	%S	%Cu	
<b>Requirements</b> - AWS E308L-16	1.00 max	0.04 max	0.03 max	0.75 max	
<b>Typical Results<sup>(3)</sup></b>	0.29-0.36	≤0.03	≤0.02	≤0.10	

## TYPICAL OPERATING PROCEDURES

Polarity <sup>(4)</sup>	Current (Amps)			
	3/32 in (2.4 mm)	1/8 in (3.2 mm)	5/32 in (4.0 mm)	3/16 in (4.8 mm)
DC+	40-70	60-100	90-140	120-185
AC	40-70	60-100	90-140	120-185

<sup>(1)</sup>Typical all weld metal. <sup>(2)</sup>Measured with 0.2% offset. <sup>(3)</sup>See test results disclaimer <sup>(4)</sup>Preferred polarity is listed first.

IMPORTANT: SPECIAL VENTILATION AND/OR EXHAUST REQUIRED

Fumes from the normal use of some welding products can contain significant quantities of components - such as chromium and manganese - which can lower the 5.0 mg/m<sup>3</sup> maximum exposure guideline for general welding fume.

BEFORE USE, READ AND UNDERSTAND THE SAFETY DATA SHEET (SDS) FOR THIS PRODUCT AND SPECIFIC INFORMATION PRINTED ON THE PRODUCT CONTAINER.

# EXCALIBUR® 308/308H-16

Stainless ▪ AWS E308-16, E308H-16

## KEY FEATURES

- Flux coating provides smooth transfer for all position except vertical down
- Higher carbon content improves strength in higher temperature applications
- Q2 Lot® - Certificate showing actual deposit composition and ferrite number (FN) by ferrite scope available online

## WELDING POSITIONS

All, except vertical down

## CONFORMANCES

<b>AWS A5:</b>	E308-16, E308H-16
<b>ABS:</b>	E308-16, E308H-16
<b>CWB/CSA:</b>	E308-16, E308H-16

## TYPICAL APPLICATIONS

- 304 and 304H stainless steels
- ASTM A743 or A744 Types CF-8 and CF-10
- Common austenitic stainless steels referred to as "18-8" steels

## DIAMETERS / PACKAGING

Diameter in (mm)	Length in (mm)	8 lb (3.6 kg) Easy Open Can	10 lb (4.5 kg) Easy Open Can
3/32 (2.4)	12 (300)	ED033083	
1/8 (3.2)	14 (350)		
5/32 (4.0)	14 (350)		ED033084
3/16 (4.8)	14 (350)		ED033085 ED033086

## MECHANICAL PROPERTIES<sup>(1)</sup> – As Required per AWS A5.4

	Yield Strength <sup>(2)</sup> MPa (ksi)	Tensile Strength MPa (ksi)	Elongation %	Ferrite Number
<b>Requirements</b> AWS E308-16 AWS E308H-16	Not Specified Not Specified	550 (80) min 550 (80) min	35 min 35 min	Not Specified Not Specified
<b>TTypical Results<sup>(3)</sup> - As-Welded</b>	435-545 (63-79)	595-640 (86-93)	41-48	4-6

## DEPOSIT COMPOSITION<sup>(1)</sup> – As Required per AWS A5.4

	%C <sup>(4)</sup>	%Cr	%Ni	%Mo	%Mn
<b>Requirements - AWS E308H-16</b>	0.04 - 0.08 <sup>(4)</sup>	18.0 - 21.0	9.0 - 11.0	0.75 max.	0.5 - 2.5
<b>Typical Results<sup>(3)</sup></b>	0.05 - 0.06	19.7 - 20.3	9.9 - 10.1	0.03 - 0.07	0.7 - 0.8
	%Si	%P	%S	%Cu	
<b>Requirements - AWS E308H-16</b>	1.00 max	0.04 max	0.03 max	0.75 max	
<b>Typical Results<sup>(3)</sup></b>	0.30 - 0.40	≤0.03	≤0.02	≤0.17	

## TYPICAL OPERATING PROCEDURES

Polarity <sup>(5)</sup>	Current (Amps)			
	3/32 in (2.4 mm)	1/8 in (3.2 mm)	5/32 in (4.0 mm)	3/16 in (4.8 mm)
DC+	40 - 70	60 - 100	90 - 140	120 - 185
AC	40 - 70	60 - 100	90 - 140	120 - 185

<sup>(1)</sup>Typical all weld metal. <sup>(2)</sup>Measured with 0.2% offset. <sup>(3)</sup>See test results disclaimer <sup>(4)</sup>AWS Requirement for E308-16 is 0.08% max carbon. <sup>(5)</sup>Preferred polarity is listed first.

IMPORTANT: SPECIAL VENTILATION AND/OR EXHAUST REQUIRED

Fumes from the normal use of some welding products can contain significant quantities of components - such as chromium and manganese - which can lower the 5.0 mg/m<sup>3</sup> maximum exposure guideline for general welding fume.

BEFORE USE, READ AND UNDERSTAND THE SAFETY DATA SHEET (SDS) FOR THIS PRODUCT AND SPECIFIC INFORMATION PRINTED ON THE PRODUCT CONTAINER.

# EXCALIBUR® 308/308L-17

Stainless ▪ AWS E308-17, E308L-17

## KEY FEATURES

- Flux coating provides smooth arc transfer in all positions except vertical down on sizes 5/32" and smaller
- Versatile electrode designed to weld several types of austenitic stainless steels
- Q2 Lot® - Certificate showing actual deposit composition and ferrite number (FN) by ferrite scope available online
- Designed with low carbon levels to help eliminate carbide precipitation in high temperature service

## WELDING POSITIONS

- 3/16 in (4.8 mm) diameter Flat and Horizontal only
- Diameters up to and including 5/32 in (4.0mm) are designed for all position welding except vertical down

## CONFORMANCES

<b>AWS A5:</b>	E309-17, E309L-17
<b>ABS:</b>	E309-17, E309L-17
<b>CWB/CSA:</b>	E309-17, E309L-17

## TYPICAL APPLICATIONS

- 304 and 304L stainless steels
- Common austenitic stainless steels referred to as "18-8" steels
- ASTM A743 or A744 Types CF-8 and CF-6

## DIAMETERS / PACKAGING

Diameter in (mm)	Length in (mm)	1 lb (0.5 kg) Plastic Tube 6 lb (2.7 kg) Master Carton	8 lb (3.6 kg) Easy Open Can	10 lb (4.5 kg) Easy Open Can
3/32 (2.4)	12 (300)	ED033093	ED033089	ED033090 ED033091 ED033092
1/8 (3.2)	14 (350)			
5/32 (4.0)	14 (350)			
3/16 (4.8)	14 (350)			

## MECHANICAL PROPERTIES<sup>(1)</sup> – As Required per AWS A5.4

	Yield Strength <sup>(2)</sup> MPa (ksi)	Tensile Strength MPa (ksi)	Elongation %	Ferrite Number
<b>Requirements</b> AWS E308-17 AWS E308L-17	Not Specified Not Specified	550 (80) min 520 (75) min	35 min 35 min	Not Specified Not Specified
<b>Typical Results<sup>(3)</sup></b> - As-Welded	425 - 470 (62 - 68)	585 - 635 (85 - 92)	42 - 50	6 - 11

## DEPOSIT COMPOSITION<sup>(1)</sup> – As Required per AWS A5.4

	%C <sup>(4)</sup>	%Cr	%Ni	%Mo	%Mn
<b>Requirements</b> - AWS E308L-17	0.04 max	18.0 - 21.0	9.0 - 11.0	0.75 max.	0.5 - 2.5
<b>Typical Results<sup>(3)</sup></b>	≤0.03	20.0 - 20.5	9.7 - 9.9	≤0.20	0.6 - 0.7
	%Si	%P	%S	%Cu	
<b>Requirements</b> - AWS E308L-17	1.00 max	0.04 max	0.03 max	0.75 max	
<b>Typical Results<sup>(3)</sup></b>	0.56 - 0.77	≤0.03	≤0.02	≤0.22	

## TYPICAL OPERATING PROCEDURES

Polarity <sup>(5)</sup>	Current (Amps)			
	3/32 in (2.4 mm)	1/8 in (3.2 mm)	5/32 in (4.0 mm)	3/16 in (4.8 mm)
DC+	40 - 80	75 - 110	95 - 150	130 - 200
AC	40 - 80	75 - 110	95 - 150	130 - 200

<sup>(1)</sup>Typical all weld metal. <sup>(2)</sup>Measured with 0.2% offset. <sup>(3)</sup>See test results disclaimer <sup>(4)</sup>AWS Requirement for E308-17 is 0.08% max. carbon. <sup>(5)</sup>Preferred polarity is listed first.

### IMPORTANT: SPECIAL VENTILATION AND/OR EXHAUST REQUIRED

Fumes from the normal use of some welding products can contain significant quantities of components - such as chromium and manganese - which can lower the 5.0 mg/m<sup>3</sup> maximum exposure guideline for general welding fume.

BEFORE USE, READ AND UNDERSTAND THE SAFETY DATA SHEET (SDS) FOR THIS PRODUCT AND SPECIFIC INFORMATION PRINTED ON THE PRODUCT CONTAINER.

# EXCALIBUR® 309/309L-15

Stainless ▪ AWS E309-15, E309L-15

## KEY FEATURES

- Fast freezing coating is great for vertical down welding
- Q2 Lot® - Certificate showing actual deposit composition and ferrite number (FN) by ferrite scope available online
- Designed with low carbon levels to help eliminate carbide precipitation

## WELDING POSITIONS

All

## CONFORMANCES

**AWS A5:** E309-15, E309L-15

**ABS:** E309-15, E309L-15

## TYPICAL APPLICATIONS

- Dissimilar joints between stainless steels

## DIAMETERS / PACKAGING

Diameter in (mm)	Length in (mm)	8 lb (3.6 kg) Easy Open Can
3/32 (2.4)	12 (300)	ED033098
1/8 (3.2)	12 (300)	ED033099

## MECHANICAL PROPERTIES<sup>(1)</sup> – As Required per AWS A5.4

	Yield Strength <sup>(2)</sup> MPa (ksi)	Tensile Strength MPa (ksi)	Elongation %	Ferrite Number
<b>Requirements</b> AWS E309-15 AWS E309L-15	Not Specified Not Specified	550 (80) min 520 (75) min	30 min 30 min	Not Specified Not Specified
<b>Typical Results<sup>(3)</sup> - As-Welded</b>	490 (71)	640 (93)	38	6-8

## DEPOSIT COMPOSITION<sup>(1)</sup> - As Required per AWS A5.4

	%C <sup>(4)</sup>	%Cr	%Ni	%Mo	%Mn
<b>Requirements - AWS E309L-15</b>	0.04 max	22.0-25.0	12.0-14.0	0.75 max.	0.5-2.5
<b>Typical Results<sup>(3)</sup></b>	≤0.03	23.6-23.9	13.6-13.8	0.03-0.05	0.7-1.0
	%Si	%P	%S	%Cu	
<b>Requirements - AWS E309L-15</b>	1.00 max	0.04 max	0.03 max	0.75 max	
<b>Typical Results<sup>(3)</sup></b>	0.74-0.82	≤0.02	≤0.01	≤0.06	

## TYPICAL OPERATING PROCEDURES

Polarity <sup>(5)</sup>	Current (Amps)	
	3/32 in (2.4 mm)	1/8 in (3.2 mm)
DC+	60-70	90-100

<sup>(1)</sup>Typical all weld metal. <sup>(2)</sup>Measured with 0.2% offset. <sup>(3)</sup>See test results disclaimer. <sup>(4)</sup>AWS Requirement for E309-15 is 0.15% max. carbon. <sup>(5)</sup>Preferred polarity is listed first.

IMPORTANT: SPECIAL VENTILATION AND/OR EXHAUST REQUIRED

Fumes from the normal use of some welding products can contain significant quantities of components - such as chromium and manganese - which can lower the 5.0 mg/m<sup>3</sup> maximum exposure guideline for general welding fume.

BEFORE USE, READ AND UNDERSTAND THE SAFETY DATA SHEET (SDS) FOR THIS PRODUCT AND SPECIFIC INFORMATION PRINTED ON THE PRODUCT CONTAINER.

# EXCALIBUR® 309/309L-16

Stainless ▪ AWS E309-16, E309L-16

## KEY FEATURES

- Flux coating provides smooth arc transfer in all welding positions, except vertical down
- Q2 Lot® - Certificate showing actual deposit composition and ferrite number (FN) by ferrite scope available online

## WELDING POSITIONS

All, except vertical down

## CONFORMANCES

**AWS A5:** E309-16, E309L-16

**ABS:** E309-16, E309L-16

**CWB/CSA:** E309-16, E309L-16

## TYPICAL APPLICATIONS

- Designed for joining stainless steel to mild or low alloy steel
- Industrial & General Fabrication

## DIAMETERS / PACKAGING

Diameter in (mm)	Length in (mm)	8 lb (3.6 kg) Easy Open Can	10 lb (4.5 kg) Easy Open Can
3/32 (2.4)	12 (300)	ED033097	
1/8 (3.2)	14 (350)		ED033094
5/32 (4.0)	14 (350)		ED033095
3/16 (4.8)	14 (350)		ED033096

## MECHANICAL PROPERTIES<sup>(1)</sup> – As Required per AWS A5.4

	Yield Strength <sup>(2)</sup> MPa (ksi)	Tensile Strength MPa (ksi)	Elongation %	Ferrite Number
<b>Requirements</b> AWS E309-16 AWS E309L-16	Not Specified Not Specified	550 (80) min 520 (75) min	30 min 30 min	Not Specified Not Specified
<b>Typical Results<sup>(3)</sup></b> - As-Welded	455-470 (66-68)	580-585 (84-85)	38-47	10-18

## DEPOSIT COMPOSITION<sup>(1)</sup> – As Required per AWS A5.4

	%C <sup>(4)</sup>	%Cr	%Ni	%Mo	%Mn
<b>Requirements</b> - AWS E309L-16	0.04 max	22.0-25.0	12.0-14.0	0.75 max	0.5-2.5
<b>Typical Results<sup>(3)</sup></b>	0.02-0.04	23.9-24.5	12.6-13.2	0.05-0.09	1.0-1.5
	%Si	%P	%S	%Cu	
<b>Requirements</b> - AWS E309L-16	1.00 max	0.04 max	0.03 max	0.75 max	
<b>Typical Results<sup>(3)</sup></b>	0.33-0.38	≤0.03	≤0.02	≤0.09	

## TYPICAL OPERATING PROCEDURES

Polarity <sup>(5)</sup>	Current (Amps)			
	3/32 in (2.4 mm)	1/8 in (3.2 mm)	5/32 in (4.0 mm)	3/16 in (4.8 mm)
DC+	40-70	60-100	90-140	120-185
AC	40-70	60-100	90-140	120-185

<sup>(1)</sup>Typical all weld metal. <sup>(2)</sup>Measured with 0.2% offset. <sup>(3)</sup>See test results disclaimer <sup>(4)</sup>AWS Requirement for E309-16 is 0.15% max. carbon. <sup>(5)</sup>Preferred polarity is listed first.

### IMPORTANT: SPECIAL VENTILATION AND/OR EXHAUST REQUIRED

Fumes from the normal use of some welding products can contain significant quantities of components - such as chromium and manganese - which can lower the 5.0 mg/m<sup>3</sup> maximum exposure guideline for general welding fume.

BEFORE USE, READ AND UNDERSTAND THE SAFETY DATA SHEET (SDS) FOR THIS PRODUCT AND SPECIFIC INFORMATION PRINTED ON THE PRODUCT CONTAINER.

# EXCALIBUR® 309/309L-17

Stainless ▪ AWS E309-17, E309L-17

## KEY FEATURES

- Flux coating provides for smooth arc transfer in the flat and horizontal positions
- Q2 Lot® - Certificate showing actual deposit composition and ferrite number (FN) by ferrite scope available online
- Designed with low carbon levels to help eliminate carbide precipitation

## WELDING POSITIONS

- 5/32 in (4.0 mm) and smaller diameter all except Vertical Down
- 3/16 in (4.8 mm) diameter Flat and Horizontal only

## CONFORMANCES

<b>AWS A5:</b>	E309-17 E309L-17
<b>ABS:</b>	E309-17 E309L-17
<b>CWB/CSA:</b>	E309-17 E309L-17

## TYPICAL APPLICATIONS

- Designed for joining stainless steel to mild or low alloy steel
- Industrial & General Fabrication

## DIAMETERS / PACKAGING

Diameter in (mm)	Length in (mm)	8 lb (3.6 kg) Easy Open Can	10 lb (4.5 kg) Easy Open Can
3/32 (2.4)	12 (300)	ED033100	
1/8 (3.2)	14 (350)		ED033101
5/32 (4.0)	14 (350)		ED033102
3/16 (4.8)	14 (350)		ED033103

## MECHANICAL PROPERTIES<sup>(1)</sup> – As Required per AWS A5.4

	Yield Strength <sup>(2)</sup> MPa (ksi)	Tensile Strength MPa (ksi)	Elongation %	Ferrite Number
<b>Requirements</b> AWS E309-17 AWS E309L-17	Not Specified Not Specified	550 (80) min 520 (75) min	30 min 30 min	Not Specified Not Specified
<b>Typical Results<sup>(3)</sup> - As-Welded</b>	455-490 (66-71)	585-620 (85-90)	37-45	7-11

## DEPOSIT COMPOSITION<sup>(1)</sup> – As Required per AWS A5.4

	%C <sup>(4)</sup>	%Cr	%Ni	%Mo	%Mn
<b>Requirements - AWS E309L-17</b>	0.04 max	22.0-25.0	12.0-14.0	0.75 max.	0.5-2.5
<b>Typical Results<sup>(3)</sup></b>	0.02-0.04	23.5-24.0	13.0-13.5	0.05-0.09	0.7-0.9
	%Si	%P	%S	%Cu	
<b>Requirements - AWS E309L-17</b>	1.00 max	0.04 max	0.03 max	0.75 max	
<b>Typical Results<sup>(3)</sup></b>	0.72-0.77	≤0.03	≤0.01	≤0.17	

## TYPICAL OPERATING PROCEDURES

Polarity <sup>(5)</sup>	Current (Amps)			
	3/32 in (2.4 mm)	1/8 in (3.2 mm)	5/32 in (4.0 mm)	3/16 in (4.8 mm)
DC+	40-80	75-110	95-150	130-200
AC	40-80	75-110	95-150	130-200

<sup>(1)</sup>Typical all weld metal. <sup>(2)</sup>Measured with 0.2% offset. <sup>(3)</sup>See test results disclaimer <sup>(4)</sup>AWS Requirement for E309-17 is 0.15% max. carbon. <sup>(5)</sup>Preferred polarity is listed first.

IMPORTANT: SPECIAL VENTILATION AND/OR EXHAUST REQUIRED

Fumes from the normal use of some welding products can contain significant quantities of components - such as chromium and manganese - which can lower the 5.0 mg/m<sup>3</sup> maximum exposure guideline for general welding fume.

BEFORE USE, READ AND UNDERSTAND THE SAFETY DATA SHEET (SDS) FOR THIS PRODUCT AND SPECIFIC INFORMATION PRINTED ON THE PRODUCT CONTAINER.

# EXCALIBUR® 310-16

Stainless ▪ AWS E310-16

## KEY FEATURES

- Used for high operating temperature stainless applications
- Multiple purpose austenitic, heat resistant stainless
- Minimal heat input required during welding

## WELDING POSITIONS

All, except vertical down

## CONFORMANCES

<b>AWS A5.4:</b>	E310-16
<b>ASME SFA-A5.4:</b>	E310-16

## TYPICAL APPLICATIONS

- Heat Shields
- Furnace Parts
- Ducting
- Welding 310/310s materials

## DIAMETERS / PACKAGING

Diameter in (mm)	Length in (mm)	8 lb (3.6 kg) Easy Open Can 24 lb (10.9 kg) Master Carton	10 lb (4.5 kg) Easy Open Can 30 lb (13.6 kg) Master Carton
3/32 (2.4)	12 (305)	ED034993	ED034994 ED034995
1/8 (3.2)	14 (355)		
5/32 (4.0)	14 (355)		

## DEPOSIT COMPOSITION<sup>(1)</sup> - As Required per AWS A5.4

	%C <sup>(3)</sup>	%Cr	%Ni	%Mo	%Mn
<b>Requirements</b> AWS E310-16	0.08 - 0.20	25.0 - 28.0	20.0 - 22.5	0.75 max	1.0 - 2.5
<b>Typical Results<sup>(2)</sup></b>	0.11	25.5	21.0	0.1	2.0
	%Si	%P	%S	%Cu	FN
<b>Requirements</b> AWS E310-16	0.75 max	0.03 max	0.03 max	0.75 max	Not Required
<b>Typical Results<sup>(2)</sup></b>	0.58	0.02	0.01	0.02	-

## TYPICAL OPERATING PROCEDURES

Polarity <sup>(4)</sup>	Current (Amps)			
	3/32 in (2.4 mm)	1/8 in (3.2 mm)	5/32 in (4.0 mm)	3/16 in (4.8 mm)
DC+	40-80	75-110	95-150	130-200
AC	40-80	75-110	95-150	130-200

<sup>(1)</sup>Typical all weld metal. <sup>(2)</sup>See test results disclaimer <sup>(3)</sup>AWS Requirement for E310-16 is 0.20% max carbon. <sup>(4)</sup>Preferred polarity is listed first.

### IMPORTANT: SPECIAL VENTILATION AND/OR EXHAUST REQUIRED

Fumes from the normal use of some welding products can contain significant quantities of components - such as chromium and manganese - which can lower the 5.0 mg/m<sup>3</sup> maximum exposure guideline for general welding fume.

BEFORE USE, READ AND UNDERSTAND THE SAFETY DATA SHEET (SDS) FOR THIS PRODUCT AND SPECIFIC INFORMATION PRINTED ON THE PRODUCT CONTAINER.



# EXCALIBUR® 312-16

Stainless ▪ AWS E312-16

## KEY FEATURES

- Can be used for joining hard to weld materials and dissimilar metals
- Applications should be limited to 800°F (420°C)
- The weld deposits exhibit high tensile strength and offer some resistance to abrasion
- Weld deposits work-hardens and allows for good wear resistance

## WELDING POSITIONS

All, except vertical down

## CONFORMANCES

<b>AWS A5.4:</b>	E312-16
<b>ASME SFA-A5.4:</b>	E312-16

## TYPICAL APPLICATIONS

- Tool Steels
- Hard to Weld Steels
- Cast and Wrought Alloys
- Dissimilar Metals

## DIAMETERS / PACKAGING

Diameter in (mm)	Length in (mm)	10 lb (4.5 kg) Easy Open Can 30 lb (13.6 kg) Master Carton
1/8 (3.2)	14 (355)	ED034996
5/32 (4.0)	14 (355)	ED034997
3/16 (4.8)	14 (355)	ED034998

## DEPOSIT COMPOSITION<sup>(1)</sup> - As Required per AWS A5.4

	%C	%Cr	%Ni	%Mo	%Mn
<b>Requirements</b> AWS E312-16	0.15 max	28.0 - 32.0	8.0 - 10.5	0.75 max	0.5 - 2.5
<b>Typical Results<sup>(2)</sup></b>	0.12	29.4	9.4	0.15	1.4
	%Si	%P	%S	%Cu	FN
<b>Requirements</b> AWS E312-16	1.00 max	0.04 max	0.03 max	0.75 max	Not Required
<b>Typical Results<sup>(2)</sup></b>	0.57	0.02	0.01	0.06	30 - 60

## TYPICAL OPERATING PROCEDURES

Polarity	Current (Amps)			
	3/32 in (2.4 mm)	1/8 in (3.2 mm)	5/32 in (4.0 mm)	3/16 in (4.8 mm)
DC+	40-80	75-110	95-150	130-200
AC	40-80	75-110	95-150	130-200

<sup>(1)</sup>Typical all weld metal. <sup>(2)</sup>See test results disclaimer

### IMPORTANT: SPECIAL VENTILATION AND/OR EXHAUST REQUIRED

Fumes from the normal use of some welding products can contain significant quantities of components - such as chromium and manganese - which can lower the 5.0 mg/m<sup>3</sup> maximum exposure guideline for general welding fume.

BEFORE USE, READ AND UNDERSTAND THE SAFETY DATA SHEET (SDS) FOR THIS PRODUCT AND SPECIFIC INFORMATION PRINTED ON THE PRODUCT CONTAINER.

# EXCALIBUR® 316/316L-15

Stainless ▪ AWS E316-15, E316L-15

## KEY FEATURES

- Flux coating is fast freezing for vertical down welding
- Molybdenum grade for increased corrosion resistance
- Q2 Lot® - Certificate showing actual deposit composition and ferrite number (FN) by ferrite scope available online
- Designed with low carbon levels to help eliminate carbide precipitation

## WELDING POSITIONS

All

## CONFORMANCES

**AWS A5:** E316-15, E316L-15

**ABS:** E316-15, E316L-15

**CWB/CSA:** E316-15, E316L-15

## TYPICAL APPLICATIONS

- Molybdenum bearing austenitic stainless steels
- Welding type 316 and 316L stainless steels
- Vertical and overhead welding applications

## DIAMETERS / PACKAGING

Diameter in (mm)	Length in (mm)	8 lb (3.6 kg) Easy Open Can
3/32 (2.4)	12 (300)	ED033108
1/8 (3.2)	12 (300)	ED033109

## MECHANICAL PROPERTIES<sup>(1)</sup> – As Required per AWS A5.4

	Yield Strength <sup>(2)</sup> MPa (ksi)	Tensile Strength MPa (ksi)	Elongation %	Ferrite Number
<b>Requirements</b> AWS E316-15 AWS E316L-15	Not Specified Not Specified	520 (75) min 490 (70) min	30 min 30 min	Not Specified Not Specified
<b>Typical Results<sup>(3)</sup> - As-Welded</b>	470 (68)	620 (90)	38	4 - 12

## DEPOSIT COMPOSITION<sup>(1)</sup> – As Required per AWS A5.4

	%C <sup>(4)</sup>	%Cr	%Ni	%Mo	%Mn
<b>Requirements - AWS E316L-15</b>	0.04 max	17.0-20.0	11.0-14.0	2.0-3.0	0.05-2.5
<b>Typical Results<sup>(3)</sup></b>	≤0.02	18.6-19.3	12.0-12.4	2.2-2.6	≤0.7
	%Si	%P	%S	%Cu	
<b>Requirements - AWS E316L-15</b>	1.00 max	0.04 max	0.03 max	0.75 max	
<b>Typical Results<sup>(3)</sup></b>	0.72-0.74	≤0.02	≤0.01	≤0.24	

## TYPICAL OPERATING PROCEDURES

Polarity	Current (Amps)	
	3/32 in (2.4 mm)	1/8 in (3.2 mm)
DC+	60-70	90-100

<sup>(1)</sup>Typical all weld metal. <sup>(2)</sup>Measured with 0.2% offset. <sup>(3)</sup>See test results disclaimer <sup>(4)</sup>AWS Requirement for E316-15 is 0.08% max. carbon.

IMPORTANT: SPECIAL VENTILATION AND/OR EXHAUST REQUIRED

Fumes from the normal use of some welding products can contain significant quantities of components - such as chromium and manganese - which can lower the 5.0 mg/m<sup>3</sup> maximum exposure guideline for general welding fume.

BEFORE USE, READ AND UNDERSTAND THE SAFETY DATA SHEET (SDS) FOR THIS PRODUCT AND SPECIFIC INFORMATION PRINTED ON THE PRODUCT CONTAINER.

# EXCALIBUR® 316/316L-16

Stainless ▪ AWS E316-16, E316L-16

## KEY FEATURES

- Flux coating provides smooth arc transfer in all welding positions, except vertical down
- Molybdenum grade for increased corrosion resistance
- Q2 Lot® - Certificate showing actual deposit composition and ferrite number (FN) by ferrite scope available online
- Designed with low carbon levels to help eliminate carbide precipitation

## WELDING POSITIONS

All, except vertical down

## CONFORMANCES

**AWS A5:** E316-16, E316L-16

**ABS:** E316-16, E316L-16

**CWB/CSA:** E316-16, E316L-16

## TYPICAL APPLICATIONS

- Molybdenum bearing austenitic stainless steels
- Type 316 and 316L stainless steel

## DIAMETERS / PACKAGING

Diameter in (mm)	Length in (mm)	8 lb (3.6 kg) Easy Open Can	10 lb (4.5 kg) Easy Open Can
3/32 (2.4)	12 (300)	ED033104	
1/8 (3.2)	14 (350)		ED033105
5/32 (4.0)	14 (350)		ED033106
3/16 (4.8)	14 (350)		ED033107

## MECHANICAL PROPERTIES<sup>(1)</sup> – As Required per AWS A5.4

	Yield Strength <sup>(2)</sup> MPa (ksi)	Tensile Strength MPa (ksi)	Elongation %	Ferrite Number
<b>Requirements</b> AWS E316-16 AWS E316L-16	Not Specified Not Specified	520 (75) min 490 (70) min	30 min 30 min	Not Specified Not Specified
<b>Typical Results<sup>(3)</sup> - As-Welded</b>	425-450 (62-65)	560-585 (81-85)	40-54	7-14

## DEPOSIT COMPOSITION<sup>(1)</sup> – As Required per AWS A5.4

	%C <sup>(4)</sup>	%Cr	%Ni	%Mo	%Mn
<b>Requirements - AWS E316L-16</b>	0.04 max	17.0-20.0	11.0-14.0	2.0-3.0	0.05-2.5
<b>Typical Results<sup>(3)</sup></b>	0.03-0.04	18.7-19.2	11.4-12.1	2.2-2.4	0.7-0.9
	%Si	%P	%S	%Cu	
<b>Requirements - AWS E316L-16</b>	1.00 max	0.04 max	0.03 max	0.75 max	
<b>Typical Results<sup>(3)</sup></b>	0.29-0.39	≤0.02	≤0.02	≤0.26	

## TYPICAL OPERATING PROCEDURES

Polarity <sup>(5)</sup>	Current (Amps)			
	3/32 in (2.4 mm)	1/8 in (3.2 mm)	5/32 in (4.0 mm)	3/16 in (4.8 mm)
DC+	40-70	60-100	90-140	120-185
AC	40-70	60-100	90-140	120-185

<sup>(1)</sup>Typical all weld metal. <sup>(2)</sup>Measured with 0.2% offset. <sup>(3)</sup>See test results disclaimer. <sup>(4)</sup>AWS Requirement for E316-16 is 0.08% max. carbon. <sup>(5)</sup>Preferred polarity is listed first.

### IMPORTANT: SPECIAL VENTILATION AND/OR EXHAUST REQUIRED

Fumes from the normal use of some welding products can contain significant quantities of components - such as chromium and manganese - which can lower the 5.0 mg/m<sup>3</sup> maximum exposure guideline for general welding fume.

BEFORE USE, READ AND UNDERSTAND THE SAFETY DATA SHEET (SDS) FOR THIS PRODUCT AND SPECIFIC INFORMATION PRINTED ON THE PRODUCT CONTAINER.

# EXCALIBUR® 316/316L-17

Stainless ▪ AWS E316-17, E316L-17

## KEY FEATURES

- Substantial ferrite content for crack resistance
- Q2 Lot® - Certificate showing actual deposit composition and ferrite number (FN) by ferrite scope available online
- Molybdenum grade for increased corrosion resistance
- Designed with low carbon levels to help eliminate carbide

## WELDING POSITIONS

- All, except vertical down 5/32 in and smaller diameter
- 3/16 in diameter on Flat and Horizontal only

## CONFORMANCES

<b>AWS A5:</b>	E316-17, E316L-17
<b>ABS:</b>	E316-17, E316L-17
<b>CWB/CSA:</b>	E316-17, E316L-17

## TYPICAL APPLICATIONS

- 316 and 316L stainless steel
- ASTM A240 Type 316 and 316L stainless steel
- ASTM A743 or A744 Types CF-8M and CF-3M
- For joining extra low carbon molybdenum bearing austenitic stainless steels

## DIAMETERS / PACKAGING

Diameter in (mm)	Length in (mm)	8 lb (3.6 kg) Easy Open Can	10 lb (4.5 kg) Easy Open Can
3/32 (2.4)	12 (300)	ED033110	
1/8 (3.2)	14 (350)		ED033111
5/32 (4.0)	14 (350)		ED033112
3/16 (4.8)	14 (350)		ED033113

## MECHANICAL PROPERTIES<sup>(1)</sup> – As Required per AWS A5.4

	Yield Strength <sup>(2)</sup> MPa (ksi)	Tensile Strength MPa (ksi)	Elongation %	Ferrite Number
<b>Requirements</b> AWS E316-17 AWS E316L-17	Not Specified Not Specified	520 (75) min. 490 (70) min.	30 min. 30 min.	Not Specified Not Specified
<b>Typical Results<sup>(3)</sup> - As-Welded</b>	469 (68)	590 (85)	45	7-14

## DEPOSIT COMPOSITION<sup>(1)</sup> – As Required per AWS A5.4

	%C <sup>(4)</sup>	%Cr	%Ni	%Mo	%Mn
<b>Requirements - AWS E316L-17</b>	0.04 max	17.0-20.0	11.0-14.0	2.0-3.0	0.5-2.5
<b>Typical Results<sup>(3)</sup></b>	≤0.03	19.1-19.7	11.6-12.7	2.1-2.4	0.8-1.0
	%Si	%P	%S	%Cu	
<b>Requirements - AWS E316L-17</b>	1.00 max	0.04 max	0.03 max	0.75 max	
<b>Typical Results<sup>(3)</sup></b>	0.61-0.72	≤0.02	≤0.01	≤0.26	

## TYPICAL OPERATING PROCEDURES

Polarity <sup>(5)</sup>	Current (Amps)			
	3/32 in (2.4 mm)	1/8 in (3.2 mm)	5/32 in (4.0 mm)	3/16 in (4.8 mm)
DC+	40-80	75-110	95-150	130-200
AC	40-80	75-110	95-150	130-200

<sup>(1)</sup>Typical all weld metal. <sup>(2)</sup>Measured with 0.2% offset. <sup>(3)</sup>See test results disclaimer <sup>(4)</sup>AWS Requirement for E316-17 is 0.08% max. carbon. <sup>(5)</sup>Preferred polarity is listed first.

IMPORTANT: SPECIAL VENTILATION AND/OR EXHAUST REQUIRED

Fumes from the normal use of some welding products can contain significant quantities of components - such as chromium and manganese - which can lower the 5.0 mg/m<sup>3</sup> maximum exposure guideline for general welding fume.

BEFORE USE, READ AND UNDERSTAND THE SAFETY DATA SHEET (SDS) FOR THIS PRODUCT AND SPECIFIC INFORMATION PRINTED ON THE PRODUCT CONTAINER.

# EXCALIBUR® 320LR-16

Stainless ▪ AWS E320LR-16

## KEY FEATURES

- Good corrosion resistance in acidic environments
- Low heat input welding procedures should be used to prevent solidification cracking

## WELDING POSITIONS

All, except vertical down

## CONFORMANCES

<b>AWS A5.4:</b>	E320LR-16
<b>ASME SFA-A5.4:</b>	E320LR-16

## TYPICAL APPLICATIONS

- Process Piping
- Heat Exchangers
- Welding Alloy 20 and similar materials
- Chemical Processing Plants

## DIAMETERS / PACKAGING

Diameter in (mm)	Length in (mm)	8 lb (3.6 kg) Easy Open Can 24 lb (10.9 kg) Master Carton	10 lb (4.5 kg) Easy Open Can 30 lb (13.6 kg) Master Carton
3/32 (2.4)	12 (305)	ED034999	ED035000 ED035001 ED035002
1/8 (3.2)	14 (355)		
5/32 (4.0)	14 (355)		
3/16 (4.8)	14 (355)		

## DEPOSIT COMPOSITION<sup>(1)</sup>

	%C	%Cr	%Ni	%Mo	%Nb+Ta	%Mn
<b>Requirements</b> AWS E320LR-16	0.03 max	19.0 - 21.0	32.0 - 36.0	2.0 - 3.0	0.4 max	1.50 - 2.50
<b>Typical Results<sup>(2)</sup></b>	0.02	19.9	33.8	2.3	0.1	1.70
	%Si	%P	%S	%Cu	FN	
<b>Requirements</b> AWS E320LR-16	0.30 max	0.020 max	0.015 max	3.0 - 4.0	Not Required	
<b>Typical Results<sup>(2)</sup></b>	0.16	0.016	0.006	3.2	-	

## TYPICAL OPERATING PROCEDURES

Polarity <sup>(3)</sup>	Current (Amps)			
	3/32 in (2.4 mm)	1/8 in (3.2 mm)	5/32 in (4.0 mm)	3/16 in (4.8 mm)
DC+	40-80	75-110	95-150	130-200
AC	40-80	75-110	95-150	130-200

<sup>(1)</sup>Typical all weld metal. <sup>(2)</sup>See test results disclaimer. <sup>(3)</sup>Preferred polarity is listed first.

IMPORTANT: SPECIAL VENTILATION AND/OR EXHAUST REQUIRED

Fumes from the normal use of some welding products can contain significant quantities of components - such as chromium and manganese - which can lower the 5.0 mg/m<sup>3</sup> maximum exposure guideline for general welding fume.

BEFORE USE, READ AND UNDERSTAND THE SAFETY DATA SHEET (SDS) FOR THIS PRODUCT AND SPECIFIC INFORMATION PRINTED ON THE PRODUCT CONTAINER.

# EXCALIBUR® 330-16

Stainless ▪ AWS E330-16

## KEY FEATURES

- Offers good heat and scale resistance to 1800°F (980°C)
- Low heat input welding procedures should be used to prevent solidification cracking
- High sulfur environments adversely affect the high temperature performance

## WELDING POSITIONS

All, except vertical down

## CONFORMANCES

<b>AWS A5.4:</b>	E330-16
<b>ASME SFA-A5.4:</b>	E330-16

## TYPICAL APPLICATIONS

- Heat Treatment
- Furnace Components
- Welding 330 stainless and similar materials
- High Temperature Environments

## DIAMETERS / PACKAGING

Diameter in (mm)	Length in (mm)	8 lb (3.6 kg) Easy Open Can 24 lb (10.9 kg) Master Carton	10 lb (4.5 kg) Easy Open Can 30 lb (13.6 kg) Master Carton
3/32 (2.4)	12 (305)	ED035003	ED035004 ED035005
1/8 (3.2)	14 (355)		
5/32 (4.0)	14 (355)		

## DEPOSIT COMPOSITION<sup>(1)</sup>

	%C <sup>(3)</sup>	%Cr	%Ni	%Mo	%Mn
<b>Requirements</b> AWS E330-16	0.18 - 0.25	14.0 - 17.0	33.0 - 37.0	0.75 max	1.0 - 2.5
<b>Typical Results<sup>(2)</sup></b>	0.21	15.5	34.3	0.13	1.7
	%Si	%P	%S	%Cu	FN
<b>Requirements</b> AWS E330-16	1.00 max	0.04 max	0.03 max	0.75 max	Not Required
<b>Typical Results<sup>(2)</sup></b>	0.49	0.02	0.003	0.06	-

## TYPICAL OPERATING PROCEDURES

Polarity <sup>(4)</sup>	Current (Amps)			
	3/32 in (2.4 mm)	1/8 in (3.2 mm)	5/32 in (4.0 mm)	3/16 in (4.8 mm)
DC+	40-80	75-110	95-150	130-200
AC	40-80	75-110	95-150	130-200

<sup>(1)</sup>Typical all weld metal. <sup>(2)</sup>See test results disclaimer <sup>(3)</sup>AWS Requirement for E316-17 is 0.08% max. carbon. <sup>(4)</sup>Preferred polarity is listed first.

### IMPORTANT: SPECIAL VENTILATION AND/OR EXHAUST REQUIRED

Fumes from the normal use of some welding products can contain significant quantities of components - such as chromium and manganese - which can lower the 5.0 mg/m<sup>3</sup> maximum exposure guideline for general welding fume.

BEFORE USE, READ AND UNDERSTAND THE SAFETY DATA SHEET (SDS) FOR THIS PRODUCT AND SPECIFIC INFORMATION PRINTED ON THE PRODUCT CONTAINER.

# EXCALIBUR® 347-16

Stainless ▪ AWS E347-16

## KEY FEATURES

- Niobium stabilized stainless steel electrodes
- The addition of niobium reduces intergranular corrosion in severe operating conditions
- Q2 Lot® - Certificate showing actual deposit composition and ferrite number (FN) by ferrite scope available online
- High tensile and yield strength results, as well as superior resistance to Sulfide Corrosion Cracking (SCC) and pitting corrosion

## WELDING POSITIONS

All, except vertical down

## CONFORMANCES

<b>AWS A5.4:</b>	E347-16
<b>ASME SFA-A5.4:</b>	E347-16

## TYPICAL APPLICATIONS

- Process Piping
- Power Generation Equipment
- Welding 321 and 347 Stainless Steels
- Powergen
- Refinery Applications

## DIAMETERS / PACKAGING

Diameter in (mm)	Length in (mm)	8 lb (3.6 kg) Easy Open Can 24 lb (10.9 kg) Master Carton	10 lb (4.5 kg) Easy Open Can 30 lb (13.6 kg) Master Carton
3/32 (2.4)	12 (305)	ED035006	ED035007 ED035008 ED035009
1/8 (3.2)	14 (355)		
5/32 (4.0)	14 (355)		
3/16 (4.8)	14 (355)		

## DEPOSIT COMPOSITION<sup>(1)</sup>

	%C	%Cr	%Ni	%Mo	%Nb+Ta	%Mn
<b>Requirements</b> AWS E347-16	0.08 max	18.0 - 21.0	9.0 - 11.0	0.75 max	8 x C to 1.00 max	0.5 - 2.5
<b>Typical Results<sup>(2)</sup></b>	0.03	19.5	10.1	0.19	0.36	1.5
	%Si	%P	%S	%Cu	FN	
<b>Requirements</b> AWS E347-16	1.00 max	0.04 max	0.03 max	0.75 max	Not Required	
<b>Typical Results<sup>(2)</sup></b>	0.54	0.02	0.01	0.16	2-8	

## TYPICAL OPERATING PROCEDURES

Polarity <sup>(3)</sup>	Current (Amps)			
	3/32 in (2.4 mm)	1/8 in (3.2 mm)	5/32 in (4.0 mm)	3/16 in (4.8 mm)
DC+	40-80	75-110	95-150	130-200
AC	40-80	75-110	95-150	130-200

<sup>(1)</sup>Typical all weld metal. <sup>(2)</sup>See test results disclaimer. <sup>(3)</sup>Preferred polarity is listed first.

### IMPORTANT: SPECIAL VENTILATION AND/OR EXHAUST REQUIRED

Fumes from the normal use of some welding products can contain significant quantities of components - such as chromium and manganese - which can lower the 5.0 mg/m<sup>3</sup> maximum exposure guideline for general welding fume.

BEFORE USE, READ AND UNDERSTAND THE SAFETY DATA SHEET (SDS) FOR THIS PRODUCT AND SPECIFIC INFORMATION PRINTED ON THE PRODUCT CONTAINER.

# EXCALIBUR® 385-16

Stainless ▪ AWS E385-16

## KEY FEATURES

- The weld metal is fully austenitic
- Minimal heat input welding procedures should be used to avoid solidification cracking

## WELDING POSITIONS

All, except vertical down

## CONFORMANCES

<b>AWS A5.4:</b>	E385-16
<b>ASME SFA A5.4:</b>	E385-16

## TYPICAL APPLICATIONS

- Welding 904L Stainless Steels
- Papermill Equipment
- Chemical process equipment
- Used in fabrication of equipment and vessels for handling and storage of sulfuric acid and phosphoric acid

## DIAMETERS / PACKAGING

Diameter in (mm)	Length in (mm)	8 lb (3.63kg) Easy Open Can 24 lb (10.89kg) Master Carton	10 lb (4.5 kg) Easy Open Can 30 lb (13.6 kg) Master Carton
3/32 (2.4)	12 (305)	ED036502	ED035010 ED035011
1/8 (3.2)	14 (355)		
5/32 (4.0)	14 (355)		

## DEPOSIT COMPOSITION<sup>(1)</sup>

	%C	%Cr	%Ni	%Mo	%Mn
<b>Requirements</b> AWS E385-16	0.03 max	19.5 - 21.5	24.0 - 26.0	4.2 - 5.2	1.0 - 2.5
<b>Typical Results<sup>(2)</sup></b>	0.02	20.4	24.9	4.8	1.4
	%Si	%P	%S	%Cu	FN
<b>Requirements</b> AWS E385-16	0.90 max	0.03 max	0.02 max	1.2 - 2.0	Not Required
<b>Typical Results<sup>(2)</sup></b>	0.34	0.01	0.01	1.6	–

## TYPICAL OPERATING PROCEDURES

Polarity <sup>(3)</sup>	Current (Amps)			
	3/32 in (2.4 mm)	1/8 in (3.2 mm)	5/32 in (4.0 mm)	3/16 in (4.8 mm)
DC+	40-80	75-110	95-150	130-200
AC	40-80	75-110	95-150	130-200

<sup>(1)</sup>Typical all weld metal. <sup>(2)</sup>See test results disclaimer. <sup>(3)</sup>Preferred polarity is listed first.

### IMPORTANT: SPECIAL VENTILATION AND/OR EXHAUST REQUIRED

Fumes from the normal use of some welding products can contain significant quantities of components - such as chromium and manganese - which can lower the 5.0 mg/m<sup>3</sup> maximum exposure guideline for general welding fume.

BEFORE USE, READ AND UNDERSTAND THE SAFETY DATA SHEET (SDS) FOR THIS PRODUCT AND SPECIFIC INFORMATION PRINTED ON THE PRODUCT CONTAINER.



# EXCALIBUR® 410-16

Stainless ▪ AWS E410-16

## KEY FEATURES

- Preheat and interpass temperatures greater than 400°F (200°C) are recommended during welding
- Great for overlay on carbon and low alloy steels

## WELDING POSITIONS

All, except vertical down

## CONFORMANCES

<b>AWS A5.4:</b>	E410-16
<b>ASME SFA-A5.4:</b>	E410-16

## TYPICAL APPLICATIONS

- Surfacing Steel Mill Rolls
- Furnace and Burner Parts
- Turbine Parts
- Welding 410 and 410s Stainless Steels

## DIAMETERS / PACKAGING

Diameter in (mm)	Length in (mm)	10 lb (4.5 kg) Tube 30 lb (13.6 kg) Master Carton
1/8 (3.2)	14 (355)	ED035012
5/32 (4.0)	14 (355)	ED035013
3/16 (4.8)	14 (355)	ED035014

## DEPOSIT COMPOSITION<sup>(1)</sup>

	%C	%Cr	%Ni	%Mo	%Mn
<b>Requirements</b> AWS E410-16	0.12 max	11.0 - 13.5	0.7 max	0.75 max	1.0 max
<b>Typical Results<sup>(2)</sup></b>	0.08	12.2	0.2	0.01	0.7
	%Si	%P	%S	%Cu	
<b>Requirements</b> AWS E410-16	0.90 max	0.04 max	0.03 max	0.75 max	
<b>Typical Results<sup>(2)</sup></b>	0.40	0.02	0.01	0.06	

## TYPICAL OPERATING PROCEDURES

Polarity <sup>(3)</sup>	Current (Amps)			
	3/32 in (2.4 mm)	1/8 in (3.2 mm)	5/32 in (4.0 mm)	3/16 in (4.8 mm)
DC+	40-80	75-110	95-150	130-200
AC	40-80	75-110	95-150	130-200

<sup>(1)</sup>Typical all weld metal. <sup>(2)</sup>See test results disclaimer. <sup>(3)</sup>Preferred polarity is listed first.

### IMPORTANT: SPECIAL VENTILATION AND/OR EXHAUST REQUIRED

Fumes from the normal use of some welding products can contain significant quantities of components - such as chromium and manganese - which can lower the 5.0 mg/m<sup>3</sup> maximum exposure guideline for general welding fume.

BEFORE USE, READ AND UNDERSTAND THE SAFETY DATA SHEET (SDS) FOR THIS PRODUCT AND SPECIFIC INFORMATION PRINTED ON THE PRODUCT CONTAINER.

# EXCALIBUR® 410NiMo-16

Stainless ▪ AWS E410NiMo-16

## KEY FEATURES

- This electrode can be used to overlay mild and low alloy steels
- Preheat and inter-pass temperatures greater than 300°F (150°C) are recommended during welding
- Post-weld heat treatment should not exceed 1150°F (620°C) as higher temperatures may result in hardening

## WELDING POSITIONS

All, except vertical down

## CONFORMANCES

<b>AWS A5.4:</b>	E410NiMo-16
<b>ASME SFA-A5.4:</b>	E410NiMo-16

## TYPICAL APPLICATIONS

- Turbines
- Valve Bodies
- High Pressure Piping
- Offshore
- Power Generation
- Welding CAGNM Stainless Steel

## DIAMETERS / PACKAGING

Diameter in (mm)	Length in (mm)	10 lb (4.5 kg) Easy Open Can 30 lb (13.6 kg) Master Carton
1/8 (3.2)	14 (355)	ED035015
5/32 (4.0)	14 (355)	ED035016
3/16 (4.8)	14 (355)	ED035018

## DEPOSIT COMPOSITION<sup>(1)</sup>

	%C	%Cr	%Ni	%Mo	%Mn
<b>Requirements</b> AWS E410NiMo-16	0.06 max	11.0 - 12.5	4.0 - 5.0	0.40 - 0.70	1.0 max
<b>Typical Results<sup>(2)</sup></b>	0.02	11.7	4.6	0.58	0.5
	%Si	%P	%S	%Cu	FN
<b>Requirements</b> AWS E410NiMo-16	0.90 max	0.04 max	0.03 max	0.75 max	Not Required
<b>Typical Results<sup>(2)</sup></b>	0.37	0.02	0.01	0.07	-

## TYPICAL OPERATING PROCEDURES

Polarity <sup>(3)</sup>	Current (Amps)			
	3/32 in (2.4 mm)	1/8 in (3.2 mm)	5/32 in (4.0 mm)	3/16 in (4.8 mm)
DC+	40-80	75-110	95-150	130-200
AC	40-80	75-110	95-150	130-200

<sup>(1)</sup>Typical all weld metal. <sup>(2)</sup>See test results disclaimer. <sup>(3)</sup>Preferred polarity is listed first.

### IMPORTANT: SPECIAL VENTILATION AND/OR EXHAUST REQUIRED

Fumes from the normal use of some welding products can contain significant quantities of components - such as chromium and manganese - which can lower the 5.0 mg/m<sup>3</sup> maximum exposure guideline for general welding fume.

BEFORE USE, READ AND UNDERSTAND THE SAFETY DATA SHEET (SDS) FOR THIS PRODUCT AND SPECIFIC INFORMATION PRINTED ON THE PRODUCT CONTAINER.

# EXCALIBUR® 630-16

Stainless ▪ AWS E630-16

## KEY FEATURES

- A precipitation hardening stainless steel covered electrode used for welding materials such as 17-4 and 17-7
- Can be used in the as welded condition or may be heat treated to obtain higher strength
- Mechanical properties of the alloy are greatly influenced by the heat treatment

## WELDING POSITIONS

All, except vertical down

## CONFORMANCES

<b>AWS A5.4:</b>	E630-16
<b>ASME SFA-A5.4:</b>	E630-16

## TYPICAL APPLICATIONS

- Hydraulic Equipment
- Impellers
- Pump Shafts
- Welding 17-4 and 17-7 Stainless Steels

## DIAMETERS / PACKAGING

Diameter in (mm)	Length in (mm)	8 lb (3.6 kg) Easy Open Can 24 lb (10.9 kg) Master Carton	10 lb (4.5 kg) Easy Open Can 30 lb (13.6 kg) Master Carton
3/32 (2.4)	12 (305)	ED035019	ED035020 ED035021 ED035022
1/8 (3.2)	14 (355)		
5/32 (4.0)	14 (355)		
3/16 (4.8)	14 (355)		

## DEPOSIT COMPOSITION<sup>(1)</sup>

	%C	%Cr	%Ni	%Mo	%Nb+Ta
<b>Requirements</b> AWS E630-16	0.05 max	16.00 - 16.75	4.5 - 5.0	0.75 max	0.15 - 0.30
<b>Typical Results<sup>(2)</sup></b>	0.03	16.30	4.8	0.11	0.16
	%Mn	%Si	%P	%S	%Cu
<b>Requirements</b> AWS E630-16	0.25 - 0.75	0.75 max	0.04 max	0.03 max	3.25 - 4.00
<b>Typical Results<sup>(2)</sup></b>	0.62	0.36	0.02	0.01	3.43

## TYPICAL OPERATING PROCEDURES

Polarity <sup>(3)</sup>	Current (Amps)			
	3/32 in (2.4 mm)	1/8 in (3.2 mm)	5/32 in (4.0 mm)	3/16 in (4.8 mm)
DC+	40-80	75-110	95-150	130-200
AC	40-80	75-110	95-150	130-200

<sup>(1)</sup>Typical all weld metal. <sup>(2)</sup>See test results disclaimer. <sup>(3)</sup>Preferred polarity is listed first.

IMPORTANT: SPECIAL VENTILATION AND/OR EXHAUST REQUIRED

Fumes from the normal use of some welding products can contain significant quantities of components - such as chromium and manganese - which can lower the 5.0 mg/m<sup>3</sup> maximum exposure guideline for general welding fume.

BEFORE USE, READ AND UNDERSTAND THE SAFETY DATA SHEET (SDS) FOR THIS PRODUCT AND SPECIFIC INFORMATION PRINTED ON THE PRODUCT CONTAINER.

# EXCALIBUR® 2209-16

Stainless ▪ AWS E2209-16

## KEY FEATURES

- Designed for welding 22% Cr Duplex Stainless Steels
- The welds offer excellent resistance to stress corrosion, cracking and pitting
- High strength welds and good corrosion resistance in a range of environments

## WELDING POSITIONS

All, except vertical down

## CONFORMANCES

<b>AWS A5.4:</b>	E2209-16
<b>ASME SFA-A5.4:</b>	E2209-16

## TYPICAL APPLICATIONS

- Offshore
- Oil and Gas
- Chemical
- Petrochemical
- Welding 2205 Stainless Steels

## DIAMETERS / PACKAGING

Diameter in (mm)	Length in (mm)	8 lb (3.6 kg) Easy Open Can 24 lb (10.9 kg) Master Carton	10 lb (4.5 kg) Easy Open Can 30 lb (13.6 kg) Master Carton
3/32 (2.4)	12 (305)	ED034985	ED034986 ED034987 ED034988
1/8 (3.2)	14 (355)		
5/32 (4.0)	14 (355)		
3/16 (4.8)	14 (355)		

## DEPOSIT COMPOSITION<sup>(1)</sup>

	%C	%Cr	%Ni	%Mo	%Mn	%Si
<b>Requirements</b> AWS E2209-16	0.04 max	21.5 - 23.5	8.5 - 10.5	2.5 - 3.5	0.5 - 2.0	1.0 max
<b>Typical Results<sup>(2)</sup></b>	0.02	22.3	9.5	3.2	1.1	0.5
	%P	%S	%N	%Cu	FN	
<b>Requirements</b> AWS E2209-16	0.04 max	0.03 max	0.08 - 0.20	0.75 max	Not Required	
<b>Typical Results<sup>(2)</sup></b>	0.02	0.01	0.16	0.06	30 - 60	

## TYPICAL OPERATING PROCEDURES

Polarity <sup>(3)</sup>	Current (Amps)			
	3/32 in (2.4 mm)	1/8 in (3.2 mm)	5/32 in (4.0 mm)	3/16 in (4.8 mm)
DC+	40-80	75-110	95-150	130-200
AC	40-80	75-110	95-150	130-200

<sup>(1)</sup>Typical all weld metal. <sup>(2)</sup>See test results disclaimer. <sup>(3)</sup>Preferred polarity is listed first.

### IMPORTANT: SPECIAL VENTILATION AND/OR EXHAUST REQUIRED

Fumes from the normal use of some welding products can contain significant quantities of components - such as chromium and manganese - which can lower the 5.0 mg/m<sup>3</sup> maximum exposure guideline for general welding fume.

BEFORE USE, READ AND UNDERSTAND THE SAFETY DATA SHEET (SDS) FOR THIS PRODUCT AND SPECIFIC INFORMATION PRINTED ON THE PRODUCT CONTAINER.

# EXCALIBUR® 2594-16

Stainless ▪ AWS E2594-16

## KEY FEATURES

- A super-duplex grade electrode that provides matching chemistry and mechanical property characteristics to wrought super-duplex alloys such as 2507 and Zeron 100, as well as to super-duplex casting alloys (ATSM A890)
- High tensile and yield strength results, as well as superior resistance to Sulfide Corrosion Cracking (SCC) and pitting corrosion
- Great corrosion resistance in a range of environments

## WELDING POSITIONS

All, except vertical down

## CONFORMANCES

<b>AWS A5.4:</b>	E2594-16
<b>ASME SFA-A5.4:</b>	E2594-16

## TYPICAL APPLICATIONS

- Process Pipework
- Pumps and Valves
- Pressure Vessels
- Welding 2507 and Zeron 100X Duplex Stainless Steels

## DIAMETERS / PACKAGING

Diameter in (mm)	Length in (mm)	8 lb (3.6 kg) Easy Open Can 24 lb (10.9 kg) Master Carton	10 lb (4.5 kg) Easy Open Can 30 lb (13.6 kg) Master Carton
3/32 (2.4)	12 (305)	ED034989	ED034990 ED034991 ED034992
1/8 (3.2)	14 (355)		
5/32 (4.0)	14 (355)		
3/16 (4.8)	14 (355)		

## DEPOSIT COMPOSITION<sup>(1)</sup>

	%C	%Cr	%Ni	%Mo	%Mn	%Si
<b>Requirements</b> AWS E2594-16	0.04 max	24.0 - 27.0	8.0 - 10.5	3.5 - 4.5	0.5 - 2.0	1.00 max
<b>Typical Results<sup>(2)</sup></b>	0.02	25.4	9.2	4.2	0.8	0.58
	%P	%S	%N	%Cu	FN	
<b>Requirements</b> AWS E2594-16	0.04 max	0.03 max	0.20 - 0.30	0.75 max	Not Required	
<b>Typical Results<sup>(2)</sup></b>	0.01	0.01	0.22	0.07	30 - 60	

## TYPICAL OPERATING PROCEDURES

Polarity <sup>(3)</sup>	Current (Amps)			
	3/32 in (2.4 mm)	1/8 in (3.2 mm)	5/32 in (4.0 mm)	3/16 in (4.8 mm)
DC+	40-80	75-110	95-150	130-200
AC	40-80	75-110	95-150	130-200

<sup>(1)</sup>Typical all weld metal. <sup>(2)</sup>See test results disclaimer. <sup>(3)</sup>Preferred polarity is listed first.

IMPORTANT: SPECIAL VENTILATION AND/OR EXHAUST REQUIRED

Fumes from the normal use of some welding products can contain significant quantities of components - such as chromium and manganese - which can lower the 5.0 mg/m<sup>3</sup> maximum exposure guideline for general welding fume.

BEFORE USE, READ AND UNDERSTAND THE SAFETY DATA SHEET (SDS) FOR THIS PRODUCT AND SPECIFIC INFORMATION PRINTED ON THE PRODUCT CONTAINER.

# E16.8.2-15

Stainless ▪ AWS E16-8-2-15

## KEY FEATURES

- Basic pipe welding electrode for 3XXH stainless steel
- Suited to the most demanding vertical and overhead welding applications, including fixed pipework in the ASME 5G/6G positions

## WELDING POSITIONS

All

## CONFORMANCES

<b>AWS A5.4</b>	E16-8-2-15
<b>BS EN 1600</b>	(E16 8 2 B)

## TYPICAL APPLICATIONS

- Transfer lines
- Furnace parts
- Thick wall steam piping
- 308H, 316H Materials
- Gas
- Steam turbine plants
- Power Generation industries

## DIAMETERS / PACKAGING

Diameter in (mm)	8.8 lb (4.0 kg) Easy Open Can	10 lb (4.5 kg) Easy Open Can
3/32 (2.5)	E168215-25	E168215-32 E168215-40
1/8 (3.2)		
5/32 (4.0)		

## MECHANICAL PROPERTIES<sup>(1)</sup> – As Required per AWS A5.4

	Yield Strength <sup>(2)</sup> MPa (ksi)	Tensile Strength MPa (ksi)	Elongation %	Charpy V-Notch J (ft·lbf) @-100°C (-148°F)
<b>Requirements</b> AWS E16-8-2-15 As-Welded	-	550 (80)	35 min	-
<b>Typical Results<sup>(3)</sup></b> As-Welded	>420 (61)	>620 (90)	40	50 (37)

## DEPOSIT COMPOSITION<sup>(1)</sup> – As Required per AWS A5.4

	%C	%Mn	%Si	%S	%P
<b>Requirements</b> AWS E16-8-2-15	0.04-0.08	0.5-2.5	0.60 max	0.03 max	0.03 max
<b>Typical Results<sup>(3)</sup></b>	0.05	1.8	0.3	0.01	0.02
	%Cr	%Ni	%Mo	%Cu	%FN
<b>Requirements</b> AWS E16-8-2-15	14.5- 16.5	7.5-9.5	1.0-2.0	0.5 max	1-6
<b>Typical Results<sup>(3)</sup></b>	15.5	8.5	1.2	0.1	3

<sup>(1)</sup>Typical all weld metal. <sup>(2)</sup>Measured with 0.2% offset. <sup>(3)</sup>See test results disclaimer.

IMPORTANT: SPECIAL VENTILATION AND/OR EXHAUST REQUIRED

Fumes from the normal use of some welding products can contain significant quantities of components - such as chromium and manganese - which can lower the 5.0 mg/m<sup>3</sup> maximum exposure guideline for general welding fume.

BEFORE USE, READ AND UNDERSTAND THE SAFETY DATA SHEET (SDS) FOR THIS PRODUCT AND SPECIFIC INFORMATION PRINTED ON THE PRODUCT CONTAINER.

# SUPERMET™ 16.8.2

Stainless ▪ AWS E16-8-2-17

## KEY FEATURES

- Manufactured with controlled hydrogen and moisture resistant flux covering technology to ensure high resistance to weld porosity
- 3XXH Materials

## WELDING POSITIONS

All

## CONFORMANCES

**AWS A5.4** E16-8-2-17  
**BS EN 1600** (E 16 8 2 R)

## TYPICAL APPLICATIONS

- 308H, 316H Materials
- Gas and steam turbine
- Petrochemical
- Chemical process plants
- Power generation industries

## DIAMETERS / PACKAGING

Diameter in (mm)	8.8 lb (4.0 kg) Easy Open Can	10 lb (4.6 kg) Easy Open Can
3/32 (2.5)	SM1682-25	SM1682-32 SM1682-40
1/8 (3.2)		
5/32 (4.0)		

## MECHANICAL PROPERTIES<sup>(1)</sup> – As Required per AWS A5.4

	Yield Strength <sup>(2)</sup> MPa (ksi)	Tensile Strength MPa (ksi)	Elongation %		Charpy V-Notch J (ft•lbf)	
			4.0 dia	5.0 dia	@20°C (68°F)	@-50°C (-58°F)
<b>Requirements</b> AWS E16-8-2-17 As-Welded	-	550 (80)	35	25 min	-	-
<b>Typical Results<sup>(3)</sup></b> As-Welded	>410 (60)	>620 (90)	42	42	>70 (52)	>50 (37)

## DEPOSIT COMPOSITION<sup>(1)</sup> – As Required per AWS A5.4

	%C	%Mn	%Si	%S	%P
<b>Requirements</b> AWS E16-8-2-17	0.08 max	2.5 max	0.60 max	0.03 max	0.03 max
<b>Typical Results<sup>(3)</sup></b>	0.05	1.0	0.45	0.01	0.02
	%Cr	%Ni	%Mo	%Cu	FN
<b>Requirements</b> AWS E16-8-2-17	14.5-16.5	7.5-9.5	1.0-2.0	0.75 max	1-6
<b>Typical Results<sup>(3)</sup></b>	15.5	8.5	1.1	0.1	3

<sup>(1)</sup>Typical all weld metal. <sup>(2)</sup>Measured with 0.2% offset. <sup>(3)</sup>See test results disclaimer.

### IMPORTANT: SPECIAL VENTILATION AND/OR EXHAUST REQUIRED

Fumes from the normal use of some welding products can contain significant quantities of components - such as chromium and manganese - which can lower the 5.0 mg/m<sup>3</sup> maximum exposure guideline for general welding fume.

BEFORE USE, READ AND UNDERSTAND THE SAFETY DATA SHEET (SDS) FOR THIS PRODUCT AND SPECIFIC INFORMATION PRINTED ON THE PRODUCT CONTAINER.

# THERMET™ 22H

Casting High Temperature Alloy

## KEY FEATURES

- Designed to match similar high carbon cast alloys
- High amount of carbon to provide excellent hot strength and oxidation resistance at 950 - 1250°C (1742 - 2282°F)
- High amount of nickel gives the alloy superior resistance to carburization and sulphidation.

## TYPICAL APPLICATIONS

- Furnace Parts
- Calcining muffles
- Hot abrasion
- Pyrolysis coils

## WELDING POSITIONS

All, except vertical down

## DIAMETERS / PACKAGING

Diameter in (mm)	Length in (mm)	26.4 lb (12 kg) Carton	30 lb (13.5 kg) Carton
1/8 (3.2)	12.2 (310)	TH22H-32	
5/32 (4.0)	12.2 (310)		TH22H-40

## MECHANICAL PROPERTIES<sup>(1)</sup>

	Yield Strength <sup>(2)</sup> MPa (ksi)	Tensile Strength MPa (ksi)	Elongation %	Hardness HV
Test Results <sup>(3)</sup> As-Welded	590 (86)	780 (113)	6	270

## DEPOSIT COMPOSITION<sup>(1)</sup>

	%C	%Mn	%Si	%S	%P
Requirements	0.4-0.6	0.5-1.5	0.5-1.2	0.02 max	0.03 max
Typical Results <sup>(3)</sup>	0.50	1	0.7	0.006	0.01
	%Cr	%Ni	%W	%Fe	
Requirements	27.0-30.0	47-54	4.0-6.0	Balance	
Typical Results <sup>(3)</sup>	28	51	5	14	

## TYPICAL OPERATING PROCEDURES

Diameter mm (in)	Polarity	Amp Range
3.2 (1/8)	DC+	85-120A
4.0 (5/32)	DC+	110-160A

<sup>(1)</sup>Typical all weld metal. <sup>(2)</sup>Measured with 0.2% offset. <sup>(3)</sup>See test results disclaimer.

IMPORTANT: SPECIAL VENTILATION AND/OR EXHAUST REQUIRED

Fumes from the normal use of some welding products can contain significant quantities of components - such as chromium and manganese - which can lower the 5.0 mg/m<sup>3</sup> maximum exposure guideline for general welding fume.

BEFORE USE, READ AND UNDERSTAND THE SAFETY DATA SHEET (SDS) FOR THIS PRODUCT AND SPECIFIC INFORMATION PRINTED ON THE PRODUCT CONTAINER.



# THERMET™ 25.35Nb

Casting High Temperature Alloys

## KEY FEATURES

- Developed to match the composition of heat-resisting castings
- Porosity-free deposits
- Designed to provide high strength and resistance to thermal shock

## TYPICAL APPLICATIONS

- Petrochemical Industry
- Reformer tubes
- Pyrolysis coils

## WELDING POSITIONS

All, except vertical down

## DIAMETERS / PACKAGING

Diameter in (mm)	Length in (mm)	26.5 lb (12 kg) Carton
1/8 (3.2)	12.6 (320)	TH2535NB-32
5/32 (4.0)	12.6 (320)	TH2535NB-40

## MECHANICAL PROPERTIES<sup>(1)</sup>

	Yield Strength <sup>(2)</sup> MPa (ksi)	Tensile Strength MPa (ksi)	Elongation %
<b>Minimum Performance</b>	300 (42) min	520 (75) min	20 min
<b>Typical Results<sup>(3)</sup></b> As-Welded	460 (67)	660 (96)	34

## DEPOSIT COMPOSITION<sup>(1)</sup>

	%C	%Mn	%Si	%S	%P	%Cr
<b>Requirements</b>	0.08-0.14	2.5-4.0	0.2-1.0	0.02 max	0.03 max	24.0-28.0
<b>Typical Results<sup>(3)</sup></b>	0.12	3.5	0.5	0.01	0.01	26
	%Ni	%Mo	%Nb	%Cu	%Pb	%Sn
<b>Requirements</b>	34.0-39.0	0.5 max	0.5-1.50	0.15 max	0.01 max	0.01 max
<b>Typical Results<sup>(3)</sup></b>	36	0.2	0.8	0.05	<0.001	0.005

## TYPICAL OPERATING PROCEDURES

Diameter mm (in)	Polarity	Amp Range
3.2 (1/8)	DC+	75-120A
4.0 (5/32)	DC+	100-155A

<sup>(1)</sup>Typical all weld metal. <sup>(2)</sup>Measured with 0.2% offset. <sup>(3)</sup>See test results disclaimer.

IMPORTANT: SPECIAL VENTILATION AND/OR EXHAUST REQUIRED

Fumes from the normal use of some welding products can contain significant quantities of components - such as chromium and manganese - which can lower the 5.0 mg/m<sup>3</sup> maximum exposure guideline for general welding fume.

BEFORE USE, READ AND UNDERSTAND THE SAFETY DATA SHEET (SDS) FOR THIS PRODUCT AND SPECIFIC INFORMATION PRINTED ON THE PRODUCT CONTAINER.

# THERMET™ 35.45.Nb

High Carbon Austenitic Alloy

## KEY FEATURES

- Superior carburization and oxidation resistance
- Design based on 25% Cr - 35% Ni for service up to 1150°C (2102°F), but with some reduction in creep strength

## TYPICAL APPLICATIONS

- Pyrolysis coils and reformer tubes
- Petrochemical industry

## WELDING POSITIONS

All, except vertical down

## DIAMETERS / PACKAGING

Diameter in (mm)	Length in (mm)	Carton lbs (kg)	Part Number
1/8 (3.2)	13.78 (350)	23.15 (10.5)	TH3545NB-32
5/32 (4.0)	13.78 (350)	27.78 (12.6)	TH3545NB-40

## MECHANICAL PROPERTIES<sup>(1)</sup>

	Tensile Strength MPa (ksi)	0.2% Proof Stress MPa (ksi)	Elongation %	Hardness HV
Typical Results <sup>(3)</sup> As-Welded	740 (107)	550 (80)	6	270

## DEPOSIT COMPOSITION<sup>(1)</sup>

	%C	%Mn	%Si	%S	%P	%Cr
Requirements	0.40-0.50	0.5-1.5	1.0-1.6	0.01 max	0.01 max	34-38
Typical Results <sup>(3)</sup> - (Weld metal wt. %)	0.45	0.9	1.2	0.005	<0.01	35
	%Ni	%Nb	%Mo	%Ti	%Fe	
Requirements	44-50	0.60-1.30	0.25 max	0.04-0.15	Balance	
Typical Results <sup>(3)</sup> - (Weld metal wt. %)	47	0.8	0.05	0.07	13	

## TYPICAL OPERATING PROCEDURES

Diameter mm (in)	Polarity	Amp Range
3.2 (1/8)	DC+	85-120A
4.0 (5/32)	DC+	110-160A

<sup>(1)</sup>Typical all weld metal. <sup>(2)</sup>Measured with 0.2% offset. <sup>(3)</sup>See test results disclaimer.

IMPORTANT: SPECIAL VENTILATION AND/OR EXHAUST REQUIRED

Fumes from the normal use of some welding products can contain significant quantities of components - such as chromium and manganese - which can lower the 5.0 mg/m<sup>3</sup> maximum exposure guideline for general welding fume.

BEFORE USE, READ AND UNDERSTAND THE SAFETY DATA SHEET (SDS) FOR THIS PRODUCT AND SPECIFIC INFORMATION PRINTED ON THE PRODUCT CONTAINER.

# THERMET™ 800Nb

Austenitic Heat Resisting Consumable

## KEY FEATURES

- Controlled carbon and niobium for optimum corrosion resistance and creep performance
- Designed to eliminate thermal fatigue and shock resistance at temperatures up to 1000°C (1832°F)
- Designed to meet deposit composition of type 800 cast at wrought alloys

## TYPICAL APPLICATIONS

- Fabrication of muffles, radiant tubes, and heat treatment trays
- Petrochemical industry
- Nuclear engineering industries
- Welding alloy 800, 800H, 800HT

## WELDING POSITIONS

All, except vertical down

## DIAMETERS / PACKAGING

Diameter in (mm)	Length in (mm)	Carton lbs (kg)	Part Number
1/8 (3.2)	13.78 (350)	29.76 (13.5)	TH800NB-32
5/32 (4.0)	13.78 (350)	29.76 (13.5)	TH800NB-40
3/16 (5.0)	17.72 (450)	39.68 (18.0)	TH800NB-50

## MECHANICAL PROPERTIES<sup>(1)</sup>

	Tensile Strength MPa (ksi)	0.2% Proof Stress MPa (ksi)	Elongation %	Reduction of area	Impact energy +20°C J	Hardness HV
Typical Results <sup>(3)</sup> As-Welded	615 (107)	410 (80)	>32	46	>55	170-220

## DEPOSIT COMPOSITION<sup>(1)</sup>

	%C	%Mn	%Si	%S	%P
Requirements	0.06-0.12	1.6-4.5	0.6 max	0.02 max	0.03 max
Typical Results <sup>(3)</sup> - (Weld metal wt. %)	0.1	2.5	0.3	0.007	0.015
	%Cr	%Ni	%Nb	%Mo	%Cu
Requirements	19.0-23.0	30.0-35.0	0.8-1.5	0.5 max	0.5 max
Typical Results <sup>(3)</sup> - (Weld metal wt. %)	21	32	1.3	0.4	0.15

## TYPICAL OPERATING PROCEDURES

Diameter mm (in)	Polarity	Amp Range
3.2 (1/8)	DC+	75-120A
4.0 (5/32)	DC+	100-155A
5.0 (3/16)	DC+	130-210A

<sup>(1)</sup>Typical all weld metal. <sup>(2)</sup>Measured with 0.2% offset. <sup>(3)</sup>See test results disclaimer.

IMPORTANT: SPECIAL VENTILATION AND/OR EXHAUST REQUIRED

Fumes from the normal use of some welding products can contain significant quantities of components - such as chromium and manganese - which can lower the 5.0 mg/m<sup>3</sup> maximum exposure guideline for general welding fume.

BEFORE USE, READ AND UNDERSTAND THE SAFETY DATA SHEET (SDS) FOR THIS PRODUCT AND SPECIFIC INFORMATION PRINTED ON THE PRODUCT CONTAINER.

# THERMET™ HP40Nb

High Carbon Austenitic Alloys ▪ BS 25.35.H.Nb.B

## KEY FEATURES

- Excellent hot strength and creep resistance from 900 - 1000°C (1650 - 1830°F)
- High levels of Cr and Ni provide good resistance to oxidation and carburization
- Designed to prevent embrittlement

## WELDING POSITIONS

All, except vertical down

## CONFORMANCES

BS:2926

25.35.H.Nb.B

## TYPICAL APPLICATIONS

- Pyrolysis coils and reformer tubes for ethylene production
- Petrochemical industry

## DIAMETERS / PACKAGING

Diameter in (mm)	Length in (mm)	Carton kg (lbs)	Part Number
1/8 (3.2)	12.6 (320)	27.12 (12.3)	THHP40NB-32
5/32 (4.0)	12.6 (320)	26.46 (12.0)	THHP40NB-40
3/16 (5.0)	12.6 (320)	27.12 (12.3)	THHP40NB-50

## MECHANICAL PROPERTIES<sup>(1)</sup>

	Tensile Strength MPa (ksi)	0.2% Proof Stress MPa (ksi)	Elongation %	Reduction of area	Hardness HV
Typical Results <sup>(3)</sup> - As-Welded	740 (107)	560 (81)	15	17	240

## DEPOSIT COMPOSITION<sup>(1)</sup>

	%C	%Mn	%Si	%S	%P
Requirements - 25.35.H.Nb.B	0.35-0.50	0.5-2.0	0.2-1.3	0.03 max	0.04 max
Typical Results <sup>(3)</sup> - (Weld metal wt. %)	0.43	1.7	0.9	0.010	0.010
	%Cr	%Ni	%Nb	%Mo	%Ti
Requirements - 25.35.H.Nb.B	23.0-27.0	32.0-36.0	0.75-1.50	0.5 max	0.02-0.20
Typical Results <sup>(3)</sup> - (Weld metal wt. %)	25.0	35.0	1.1	0.1	0.08

## TYPICAL OPERATING PROCEDURES

Diameter mm (in)	Polarity	Amp Range
3.2 (1/8)	DC+	75-120A
4.0 (5/32)	DC+	100-155A
5.0 (3/16)	DC+	130-210A

<sup>(1)</sup>Typical all weld metal. <sup>(2)</sup>Measured with 0.2% offset. <sup>(3)</sup>See test results disclaimer.

IMPORTANT: SPECIAL VENTILATION AND/OR EXHAUST REQUIRED

Fumes from the normal use of some welding products can contain significant quantities of components - such as chromium and manganese - which can lower the 5.0 mg/m<sup>3</sup> maximum exposure guideline for general welding fume.

BEFORE USE, READ AND UNDERSTAND THE SAFETY DATA SHEET (SDS) FOR THIS PRODUCT AND SPECIFIC INFORMATION PRINTED ON THE PRODUCT CONTAINER.

# THERMET™ HP50WCO

High Carbon Austenitic Alloys

## KEY FEATURES

- Additions of cobalt and tungsten for maintaining matrix strength
- High carbon, high alloy for excellent hot strength and oxidation resistance at service temperatures of 950 - 1250 °C (1740 - 2280 °F)

## TYPICAL APPLICATIONS

- Highly stressed furnace parts, sintering and calcining muffles
- Cement kiln components resistant to hot abrasion, radiant tubes, and pyrolysis coils

## WELDING POSITIONS

All, except vertical down

## DIAMETERS / PACKAGING

Diameter in (mm)	Length in (mm)	Carton lbs (kg)	Part Number
1/8 (3.2)	12.6 (320)	26.46 (12.0)	THHP50WCO-32
5/32 (4.0)	12.6 (320)	29.10 (13.2)	THHP50WCO-40

## MECHANICAL PROPERTIES<sup>(1)</sup>

	Tensile Strength MPa (ksi)	0.2% Proof Stress MPa (ksi)	Elongation %	Reduction of area	Hardness HV
Test Results <sup>(3)</sup> As-Welded	840 (122)	610 (88)	8.5	6	265

## DEPOSIT COMPOSITION<sup>(1)</sup>

	%C	%Mn	%Si	%S	%P	%Cr
Requirements	0.40-0.60	0.5-1.5	0.2-1.2	0.02 max	0.03 max	24.0-28.0
Test Results <sup>(3)</sup> (Weld metal wt. %)	0.50	0.6	0.5	0.008	0.010	25
	%Ni	%Co	%W	%Mo	%Cu	%Fe
Requirements	34.0-40.0	13.0-18.0	4.0-6.0	0.5 max	0.5 max	Balance
Test Results <sup>(3)</sup> (Weld metal wt. %)	35	14	4.6	0.05	0.05	19

## TYPICAL OPERATING PROCEDURES

Diameter mm (in)	Polarity	Amp Range
3.2 (1/8)	DC+	85-120A
4.0 (5/32)	DC+	110-160A

<sup>(1)</sup> Typical all weld metal. <sup>(2)</sup> Measured with 0.2% offset. <sup>(3)</sup> See test results disclaimer.

IMPORTANT: SPECIAL VENTILATION AND/OR EXHAUST REQUIRED

Fumes from the normal use of some welding products can contain significant quantities of components - such as chromium and manganese - which can lower the 5.0 mg/m<sup>3</sup> maximum exposure guideline for general welding fume.

BEFORE USE, READ AND UNDERSTAND THE SAFETY DATA SHEET (SDS) FOR THIS PRODUCT AND SPECIFIC INFORMATION PRINTED ON THE PRODUCT CONTAINER.

# ULTRAMET® 308LCF

Stainless ▪ AWS E308L-16

## KEY FEATURES

- Controlled Low Ferrite (Range 3-6)
- Charpy V-Notch test results capable of exceeding 27 J (20 ft•lbf) @ -196°C (-320°F)
- Exceeds 15 mils (0.38 mm) of lateral expansion @ -196°C (-320°F)
- Q2 Lot® - Certificates showing actual wire composition available online
- Batch Managed Inventory

## WELDING POSITIONS

All

## CONFORMANCES

<b>AWS A5.4:</b>	E308L-16
<b>ASME SFA 5.4:</b>	E308L-16

## TYPICAL APPLICATIONS

- LNG Storage
- Cryogenic Vessels and Piping

## TYPICAL BASE METALS

- 304L stainless steel
- 18/8 steels with service temperatures down to -196°C (-320°F)

## DIAMETERS / PACKAGING

Diameter in (mm)	25 lb (11.4 kg) Carton	29lb (13.5kg) Carton	10 lb (4.5 kg) Carton
3/32 (2.5)	UM308LCF-25	UM308LCF-32	UM308LCF-40
1/8 (3.2)			
5/32 (4.0)			

## MECHANICAL PROPERTIES<sup>(1)</sup> – As Required per AWS A5.4

	Yield Strength <sup>(2)</sup> MPa (ksi)	Tensile Strength MPa (ksi)	Elongation %	Charpy V-Notch J (ft•lb) -196°C (-320°F)	Lateral Expansion mm (mils) -196°C (-320°F)
<b>Requirements</b> AWS 5.4: E308L-16	Not Specified	520 (75) min	30 min	Not Specified	Not Specified
<b>Typical Results<sup>(3)</sup></b>	445 (65)	600 (87)	50	45 (33)	0.50 (19.7)

## DEPOSIT COMPOSITION<sup>(1)</sup> – As Required per AWS A5.4

	%C	%Mn	%Si	%S	%P
<b>Requirements</b>	0.04 max	0.5 - 2.5	1.00 max	0.03 max	0.03 max
<b>Typical Results<sup>(3)</sup></b>	< 0.025	1.0	0.60	0.01	0.02
	%Cr	%Ni	%Mo	%Cu	%FN
<b>Requirements</b>	18.0-21.0	9.0-11.0	0.75 max	0.75 max	Not Specified
<b>Typical Results<sup>(3)</sup></b>	18.5	10.0	0.1	<0.1	3

## TYPICAL OPERATING PROCEDURES

Polarity <sup>(4)</sup>	Current (Amps)	
	2.5 mm (3/32 in)	3.2 mm (1/8 in)
DC+	60-90	75-120
AC	40-80	75-120

<sup>(1)</sup>Typical all weld metal. <sup>(2)</sup>Measured with 0.2% offset. <sup>(3)</sup>See test results disclaimer. <sup>(4)</sup>Preferred polarity is listed first.

IMPORTANT: SPECIAL VENTILATION AND/OR EXHAUST REQUIRED

Fumes from the normal use of some welding products can contain significant quantities of components - such as chromium and manganese - which can lower the 5.0 mg/m<sup>3</sup> maximum exposure guideline for general welding fume.

BEFORE USE, READ AND UNDERSTAND THE SAFETY DATA SHEET (SDS) FOR THIS PRODUCT AND SPECIFIC INFORMATION PRINTED ON THE PRODUCT CONTAINER.

# ULTRAMET® 316LCF

Stainless ▪ AWS E316L-16

## KEY FEATURES

- Controlled Low Ferrite (Range 3-5)
- Charpy V-Notch test results capable of exceeding 27 J (20 ft•lbf) @ -196 °C (-320 °F)
- Exceeds 15 mils (0.38 mm) of lateral expansion @ -196 °C (-320 °F)
- Q2 Lot® - Certificates showing actual wire chemistry available online
- Batch Managed Inventory

## WELDING POSITIONS

All

## CONFORMANCES

<b>AWS A5.4:</b>	E316L-16
<b>ASME SFA 5.4:</b>	E316L-16

## TYPICAL APPLICATIONS

- LNG Storage
- Cryogenic Vessels and Piping

## TYPICAL BASE METALS

- 316L stainless steel

## DIAMETERS / PACKAGING

Diameter in (mm)	25 lb (11.4 kg) Carton	29 lb (13.5 kg) Carton	10 lb (4.5 kg) Carton
3/32 (2.5) 1/8 (3.2) 5/32 (4.0)	ED034813, UM316LCF-25*	ED034814, UM316LCF-32*	UM316LCF-40

\*The Metrode part number will be replacing the current EDO numbers after the inventory has been depleted.

## MECHANICAL PROPERTIES<sup>(1)</sup> – As Required per AWS A5.4

	Yield Strength <sup>(2)</sup> MPa (ksi)	Tensile Strength MPa (ksi)	Elongation %	Charpy V-Notch J (ft•lb) -196 °C (-320 °F)	Lateral Expansion mm (mils) -196 °C (-320 °F)
<b>Requirements</b> AWS 5.4 E316L-16	Not Specified	490 (70)	30 min	Not Specified	Not Specified
<b>Typical Performance<sup>(3)</sup></b>	440 (64)	595 (83)	43	30 (22)	0.45 (18)

## DEPOSIT COMPOSITION<sup>(1)</sup> – As Required per AWS A5.4

	%C	%Mn	%Si	%S	%P
<b>Requirements</b>	0.04 max	0.5 - 2.5	1.00 max	0.03 max	0.04 max
<b>Typical Results<sup>(3)</sup></b>	<0.03	1.0	0.60	0.01	0.02
	%Cr	%Ni	%Mo	%Cu	%FN
<b>Requirements</b>	17.0-20.0	11.0-14.0	2.0-3.0	0.75 max	Not Specified
<b>Typical Results<sup>(3)</sup></b>	18.0	12.0	2.2	<0.1	3

## TYPICAL OPERATING PROCEDURES

Polarity <sup>(4)</sup>	Current (Amps)	
	2.5 mm (3/32 in)	3.2 mm (1/8 in)
DC+	60-90	75-120
AC	40-80	75-120

<sup>(1)</sup>Typical all weld metal. <sup>(2)</sup>Measured with 0.2% offset. <sup>(3)</sup>See test results disclaimer. <sup>(4)</sup>Preferred polarity is listed first.

### IMPORTANT: SPECIAL VENTILATION AND/OR EXHAUST REQUIRED

Fumes from the normal use of some welding products can contain significant quantities of components - such as chromium and manganese - which can lower the 5.0 mg/m<sup>3</sup> maximum exposure guideline for general welding fume.

BEFORE USE, READ AND UNDERSTAND THE SAFETY DATA SHEET (SDS) FOR THIS PRODUCT AND SPECIFIC INFORMATION PRINTED ON THE PRODUCT CONTAINER.

# ULTRAMET B™ 316NF

Stainless ▪ Similar to AWS A5.4 (E316LMn-15) ▪ E 18 15 3 L B 4 2

## KEY FEATURES

- Controlled carbon and niobium for optimum corrosion resistance and creep performance
- Designed to eliminate thermal fatigue and shock resistance at temperatures up to 1000°C (1832°F)

## WELDING POSITIONS

All, except vertical down

## CONFORMANCES

BS EN 1600

E 18 15 3 L B 4 2

\* Similar to E316LMn-15

## TYPICAL APPLICATIONS

- Fabrication of fittings for minesweepers
- Offshore industry – Downhole instrument collars
- LPG & LNG storage vessels

## DIAMETERS / PACKAGING

Diameter mm (in)	Length mm (in)	Carton kg (lbs)	Part Number
3.2 (1/8)	350 (13.78)	13.5 (29.76)	UMB316NF-32
4.0 (5/32)	350 (13.78)	13.5 (29.76)	UMB316NF-40
5.0 (3/16)	-	16.5 (36.4)	UMB316NF-50

## MECHANICAL PROPERTIES<sup>(1)</sup>

	Tensile Strength MPa (ksi)	0.2% Proof Stress MPa (ksi)	Elongation %	Reduction of area	Charpy V-Notch J (ft·lb) -196°C (-320°F) J	Lateral Expansion mm (mils) -196°C (-320°F)
<b>Typical Results<sup>(3)</sup></b> As-Welded	610 (89)	440 (64)	38	50	50	0.6 (24)

## DEPOSIT COMPOSITION<sup>(1)</sup> – As Required per Similar to AWS A5.4

	%C	%Mn	%Si	%S	%P
<b>Requirements</b> per E 18 15 3 L B 4 2	0.04 max	2.5-4.0	0.9 max	0.025 max	0.030 max
<b>Typical Results<sup>(3)</sup></b> (Weld metal wt. %)	<0.03	3.5	0.4	0.01	0.02
	%Cr	%Ni	%Mo	%Cu	%N
<b>Requirements</b> per E 18 15 3 L B 4 2	16.5-19.5	14.0-17.0	2.5-3.5	0.5 max	0.1-0.2
<b>Typical Results<sup>(3)</sup></b> (Weld metal wt. %)	18	16	2.8	<0.1	0.15

## TYPICAL OPERATING PROCEDURES

Diameter mm (in)	Polarity	Amp Range
3.2 (1/8)	DC+	75-120A
4.0 (5/32)	DC+	100-155A
5.0 (3/16)	DC+	130-210A

<sup>(1)</sup> Typical all weld metal. <sup>(2)</sup> Measured with 0.2% offset. <sup>(3)</sup> See test results disclaimer

IMPORTANT: SPECIAL VENTILATION AND/OR EXHAUST REQUIRED

Fumes from the normal use of some welding products can contain significant quantities of components - such as chromium and manganese - which can lower the 5.0 mg/m<sup>3</sup> maximum exposure guideline for general welding fume.

BEFORE USE, READ AND UNDERSTAND THE SAFETY DATA SHEET (SDS) FOR THIS PRODUCT AND SPECIFIC INFORMATION PRINTED ON THE PRODUCT CONTAINER.



# BLUE MAX<sup>®</sup> MIG 307\_MOD

Stainless ▪ Similar to AWS ER307

## KEY FEATURES

- Austenitic stainless steel
- 7% Manganese (Mn) increases resistance to hot cracking between dissimilar steels
- Q2 Lot<sup>®</sup> - Certificates showing actual wire composition and calculated ferrite number (FN) available online

## WELDING POSITIONS

All

## CONFORMANCES

ISO: G 18 8 Mn

*\*Similar to ER307*

## TYPICAL APPLICATIONS

- Automotive exhaust systems
- Armor Plate (military)
- Designed for joining dissimilar stainless steels
- Work hardening manganese steel

## SHIELDING GAS

Short Circuiting Transfer

90% He / 7.5% Argon / 2.5% CO<sub>2</sub>

Axial Spray Transfer

98% Argon / Balance O<sub>2</sub>

## DIAMETERS / PACKAGING

Diameter in (mm)	33 lb (15 kg) Steel Spool
0.045 (1.2)	ED036050

## WIRE COMPOSITION<sup>(1)</sup>

	%C	%Mn	%Si	%Cr	%Ni
Typical Results <sup>(2)</sup>	0.08	7.1	0.80	18.8	8.6
	%S	%P	%Mo	%Cu	%FN
Typical Results <sup>(2)</sup>	0.009	0.023	-	-	-

## TYPICAL OPERATING PROCEDURES

Diameter in (mm)	Voltage (volts)	Amperage	Gas Flow	Gas
0.045 (1.1)	28-32	180-250	30-50 CFH	98/2 (Ar/O <sub>2</sub> )

<sup>(1)</sup>Typical wire composition. <sup>(2)</sup>See test results disclaimer

### IMPORTANT: SPECIAL VENTILATION AND/OR EXHAUST REQUIRED

Fumes from the normal use of some welding products can contain significant quantities of components - such as chromium and manganese - which can lower the 5.0 mg/m<sup>3</sup> maximum exposure guideline for general welding fume.

BEFORE USE, READ AND UNDERSTAND THE SAFETY DATA SHEET (SDS) FOR THIS PRODUCT AND SPECIFIC INFORMATION PRINTED ON THE PRODUCT CONTAINER.

# BLUE MAX<sup>®</sup> MIG 308H

Stainless ▪ AWS ER308H

## KEY FEATURES

- Provides a higher carbon deposition (minimum of 0.04% carbon) than Blue Max MIG 308L
- The higher carbon deposit provides creep strength and higher tensile strength at elevated service temperatures
- Q2 Lot<sup>®</sup> - Certificate showing actual wire composition and calculated ferrite number (FN) available online

## WELDING POSITIONS

All

## CONFORMANCES

AWS A5: ER308 ER308H

## TYPICAL APPLICATIONS

- Chemical
- Petrochemical Industries
- Distillery
- Catalytic Crackers
- Pulp and Paper
- Welding 302/304H/305 Stainless Steels
- Restaurant Industries

## SHIELDING GAS

98% Argon / Balance O<sub>2</sub>

## DIAMETERS / PACKAGING

Diameter in (mm)	33 lb (15 kg) Steel Spool	500 lb (227 kg) Accu-Trak <sup>®</sup> Drum
0.030 (0.8)	ED035038	
0.035 (0.9)	ED035039	
0.045 (1.1)	ED035040	ED035041
1/16 (1.6)	ED035042	

## WIRE COMPOSITION<sup>(1)</sup> – As Required per AWS A5.9

	%C <sup>(3)</sup>	%Cr	%Ni	%Mo	%Mn
<b>Requirements</b> AWS ER308H	0.04 - 0.08	19.5 - 22.0	9.00 - 11.00	0.50 max	1.0 - 2.5
<b>Typical Results<sup>(2)</sup></b>	0.06	19.9	9.7	0.07	1.8
	%Si	%P	%S	%Cu	FN
<b>Requirements</b> AWS ER308H	0.30 - 0.65	0.03 max	0.03 max	0.75 max	Not Required
<b>Typical Results<sup>(2)</sup></b>	0.44	0.02	0.006	0.10	7

## TYPICAL OPERATING PROCEDURES

Diameter in (mm)	Voltage (volts)	Amperage	Gas Flow	Gas
0.030 (0.8)	26-29	160-210	30-50 CFH	98/2 (Ar/O <sub>2</sub> )
0.035 (0.9)	26-29	160-210	30-50 CFH	90/7.5/2.5
0.045 (1.1)	28-32	180-250	30-50 CFH	(He/Ar/CO <sub>2</sub> )
0.062 (1.6)	29-33	200-280	30-50 CFH	

<sup>(1)</sup>Typical wire chemistry. <sup>(2)</sup>See test results disclaimer. <sup>(3)</sup>AWS Requirements for ER308 is 0.08% max carbon.

IMPORTANT: SPECIAL VENTILATION AND/OR EXHAUST REQUIRED

Fumes from the normal use of some welding products can contain significant quantities of components - such as chromium and manganese - which can lower the 5.0 mg/m<sup>3</sup> maximum exposure guideline for general welding fume.

BEFORE USE, READ AND UNDERSTAND THE SAFETY DATA SHEET (SDS) FOR THIS PRODUCT AND SPECIFIC INFORMATION PRINTED ON THE PRODUCT CONTAINER.

# BLUE MAX<sup>®</sup> MIG 308LSi

Stainless ▪ AWS ER308Si, ER308LSi

## KEY FEATURES

- High silicon level for increased puddle fluidity and toe wetting
- Proprietary surface lubricant for steady feeding and arc stability
- Versatile electrode designed to weld CrNi austenitic stainless steels
- Q2 Lot<sup>®</sup> - Certificate showing actual wire composition and calculated ferrite number (FN) available online
- Used to primarily weld equipment made with 304 type stainless steel
- Higher silicon content improves wetting of the weld metal and potentially higher travel speeds compared to standard 308L products

## WELDING POSITIONS

All

## CONFORMANCES

<b>AWS A5:</b>	ER308LSi, ER308Si
<b>ABS:</b>	ER308LSi, ER308Si
<b>CWB/CSA:</b>	ER308LSi, ER308Si
<b>ISO:</b>	S5308LSi

## TYPICAL APPLICATIONS

- 304 and 304L stainless steels
- Common austenitic stainless steels referred to as "18-8" steels
- ASTM A743 or A744 Types CF-8 and CF-3
- Exceptionally performs at high wire feed speeds

## SHIELDING GAS

Short Circuiting Transfer:

90% He/ 7.5% Ar/ 2.5% O<sub>2</sub>

Axial Spray Transfer:

98% Argon / Balance Oxygen

## DIAMETERS / PACKAGING

Diameter in (mm)	25 lb (11.3 kg) Plastic Spool	250 lb (113 kg) Accu-Trak <sup>®</sup> Drum	500 lb (227 kg) Speed Feed <sup>®</sup> Reel	1000 lb (454 kg) Precise-Trak <sup>™</sup> Reel
0.030 (0.8)	ED023961			
0.035 (0.9)	ED019292	ED035060		ED032834
0.045 (1.1)	ED019293	ED035063		
1/16 (1.6)	ED019294		ED035066	

## MECHANICAL PROPERTIES<sup>(1)</sup> – As Required per AWS A5.9

	Yield Strength <sup>(2)</sup> MPa (ksi)	Tensile Strength MPa (ksi)	Elongation %	Ferrite Number
Typical Results <sup>(3)</sup> - As-Welded	455 (66)	635 (92)	46	10

<sup>(1)</sup>Typical all weld metal. <sup>(2)</sup>Measured with 0.2% offset. <sup>(3)</sup>See test results disclaimer

**WIRE COMPOSITION<sup>(1)</sup> – As Required per AWS A5.9**

	%C <sup>(4)</sup>	%Cr	%Ni	%Mo	%Mn
<b>Requirements</b> - AWS ER308LSi	0.03 max	19.5-22.0	9.0-11.0	0.75 max	1.0-2.5
<b>Typical Results<sup>(3)</sup></b>	0.01	19.9	10.0	0.16	2.1
	%Si	%P	%S	%N <sup>(5)</sup>	%Cu
<b>Requirements</b> - AWS ER308LSi	0.65-1.00	0.03 max	0.03 max	Not Specified	0.75 max
<b>Typical Results<sup>(3)</sup></b>	0.88	0.02	0.01	0.05	0.17

**TYPICAL OPERATING PROCEDURES**

Diameter, Polarity Shielding Gas	CTWD <sup>(6)</sup> mm (in)	Wire Feed Speed m/min (in/min)	Voltage (Volts)	Approx. Current (Amps)	Deposition Rate kg/hr (lb/hr)
<i>Short Circuit Transfer</i>					
0.035 in (0.9 mm), DC+ 90% He / 7-1/2% Ar / 2-1/2% CO <sub>2</sub>	13 (1/2)	3.0 (120)	19-20	55	0.9 (2.0)
	13 (1/2)	4.6 (180)	19-20	85	1.4 (3.0)
	13 (1/2)	5.8 (230)	20-21	105	1.8 (3.9)
	13 (1/2)	7.6 (300)	20-21	125	2.3 (5.0)
	13 (1/2)	8.9 (350)	21-22	140	2.7 (5.9)
	13 (1/2)	10.2 (400)	22-23	160	3.1 (6.7)
0.045 in (1.1 mm), DC+ 90% He / 7-1/2% Ar / 2-1/2% CO <sub>2</sub>	13 (1/2)	2.5 (100)	19-20	100	1.1 (2.8)
	13 (1/2)	3.2 (125)	19-20	120	1.5 (3.5)
	13 (1/2)	3.8 (150)	21	135	1.7 (4.2)
	13 (1/2)	4.4 (175)	21	140	2.0 (4.8)
	13 (1/2)	5.6 (220)	22	170	2.6 (6.1)
	13 (1/2)	6.4 (250)	22-23	175	2.9 (6.9)
13 (1/2)	7.0 (275)	22-23	185	3.2 (7.6)	
<i>Axial Spray Transfer</i>					
0.035 in (0.9 mm), DC+ 98% Ar/2% O <sub>2</sub>	13 (1/2)	10.2 (400)	22	180	3.1 (6.7)
	13 (1/2)	10.8 (425)	23	190	3.3 (7.1)
	13 (1/2)	11.4 (450)	23	200	3.5 (7.5)
	13 (1/2)	12.1 (475)	23	210	3.7 (8.0)
0.045 in (1.1 mm), DC+ 98% Ar/2% O <sub>2</sub>	13 (1/2)	6.1 (240)	23	195	2.8 (6.6)
	13 (1/2)	6.6 (260)	24	230	3.0 (7.2)
	13 (1/2)	7.6 (300)	24	240	3.5 (8.3)
	13 (1/2)	8.3 (325)	25	250	3.8 (9.0)
	13 (1/2)	9.1 (360)	25	260	4.2 (10.0)
1/16 in (1.6 mm), DC+ 98% Ar/2% O <sub>2</sub>	19 (3/4)	4.4 (175)	25	260	4.3 (9.2)
	19 (3/4)	5.1 (200)	26	310	4.9 (10.5)
	19 (3/4)	6.4 (250)	26	330	6.2 (13.1)
	19 (3/4)	7.0 (275)	27	360	6.8 (14.4)
	19 (3/4)	7.6 (300)	28	390	7.4 (15.8)

<sup>(1)</sup>Typical all weld metal. <sup>(2)</sup>Measured with 0.2% offset. <sup>(3)</sup>See test results disclaimer <sup>(4)</sup>AWS Requirements for ER308Si is 0.08% max carbon. <sup>(5)</sup>Included in 0.50% max. for other elements not specified.

<sup>(6)</sup>To estimate ESO, subtract 1/8 in (3 mm) from CTWD.

**IMPORTANT: SPECIAL VENTILATION AND/OR EXHAUST REQUIRED**

Fumes from the normal use of some welding products can contain significant quantities of components - such as chromium and manganese - which can lower the 5.0 mg/m<sup>3</sup> maximum exposure guideline for general welding fume.

BEFORE USE, READ AND UNDERSTAND THE SAFETY DATA SHEET (SDS) FOR THIS PRODUCT AND SPECIFIC INFORMATION PRINTED ON THE PRODUCT CONTAINER.

# BLUE MAX<sup>®</sup> MIG 308L

Stainless ▪ AWS ER308L

## KEY FEATURES

- Reduced carbon levels (0.03% max) offer increased resistance to inter-granular corrosion
- Q2 Lot<sup>®</sup> - Certificate showing actual wire composition and calculated ferrite number (FN) available online

## WELDING POSITIONS

All

## CONFORMANCES

<b>AWS A5:</b>	ER308, ER308L
<b>ABS:</b>	ER308, ER308L
<b>CWB/CSA:</b>	ER308, ER308L

## TYPICAL APPLICATIONS

- Designed for welding 304/304L Stainless Steels
- ASTM A743 or 744 Types CF-8 and CF-3 castings

## SHIELDING GAS

90% He/ 7.5% Ar/ 2.5% O<sub>2</sub>

## DIAMETERS / PACKAGING

Diameter in (mm)	33 lb (15 kg) Steel Spool	250 lb (113 kg) Accu-Trak <sup>®</sup> Drum	500 lb (227 kg) Accu-Trak <sup>®</sup> Drum
0.030 (0.8)	ED035043	ED035048	ED035049 ED035054
0.035 (0.9)	ED035045		
0.045 (1.1)	ED035051		
1/16 (1.6)	ED035056		

## WIRE COMPOSITION<sup>(1)</sup> – As Required per AWS A5.9

	%C <sup>(3)</sup>	%Cr	%Ni	%Mo	%Mn
<b>Requirements</b> AWS ER308L	0.03 max	19.5 - 22.0	9.00 - 11.00	0.75 max	1.0 - 2.5
<b>Typical Results<sup>(2)</sup></b>	0.01	19.7	9.7	0.17	1.7
	%Si	%P	%S	%Cu	FN
<b>Requirements</b> AWS ER308L	0.30 - 0.65	0.03 max	0.03 max	0.75 max	Not Required
<b>Typical Results<sup>(2)</sup></b>	0.37	0.02	0.01	0.18	8 - 14

## TYPICAL OPERATING PROCEDURES

Diameter in (mm)	Voltage (volts)	Amperage	Gas Flow	Gas
0.035 (0.9)	26-29	160-210	30-50 CFH	98/2 (Ar/O <sub>2</sub> )
0.045 (1.1)	28-32	180-250	30-50 CFH	
0.062 (1.6)	29-33	200-280	30-50 CFH	

<sup>(1)</sup>Typical wire chemistry. <sup>(2)</sup>See test results disclaimer. <sup>(3)</sup>AWS Requirements for ER308 is 0.08% max carbon.

### IMPORTANT: SPECIAL VENTILATION AND/OR EXHAUST REQUIRED

Fumes from the normal use of some welding products can contain significant quantities of components - such as chromium and manganese - which can lower the 5.0 mg/m<sup>3</sup> maximum exposure guideline for general welding fume.

BEFORE USE, READ AND UNDERSTAND THE SAFETY DATA SHEET (SDS) FOR THIS PRODUCT AND SPECIFIC INFORMATION PRINTED ON THE PRODUCT CONTAINER.

# BLUE MAX<sup>®</sup> MIG 308LCF

Stainless ▪ AWS ER308L

## KEY FEATURES

- Controlled Low Ferrite (Range 3-6 FN)
- Charpy V-Notch test results capable of exceeding 27 J (20 ft·lbf) @ -196°C (-320°F)
- Exceeds 15 mils (0.38 mm) of lateral expansion @ -196°C (-320°F)
- Q2 Lot<sup>®</sup> - Certificates showing actual wire chemistry available online

## WELDING POSITIONS

All

## SHIELDING GAS

98% Argon / 2% Oxygen

## CONFORMANCES

AWS A5: ER308, ER308L

## TYPICAL APPLICATIONS

- LNG Storage
- Cryogenic Vessels and Piping

## TYPICAL BASE METALS

- 304L stainless steel
- 18/8 steels with service temperatures down to -196°C (-320°F)

## DIAMETERS / PACKAGING

Diameter in (mm)	33 lb (15kg) Steel Spool
0.035 (0.9)	ED034909
0.045 (1.1)	ED034910

## WIRE COMPOSITION<sup>(1)</sup> – As Required per AWS A5.9

	%C	%Cr	%Ni	%Mo	%Mn
<b>Requirements</b> AWS ER308L	0.03 max	19.5 - 22.0	9.00 - 11.00	0.75 max	1.0 - 2.5
<b>Typical Results<sup>(3)</sup></b>	0.01	19.7	9.7	0.17	1.7
	%Si	%P	%S	%Cu	FN
<b>Requirements</b> AWS ER308L	0.30 - 0.65	0.03 max	0.03 max	0.75 max	Not Required
<b>Typical Results<sup>(3)</sup></b>	0.37	0.02	0.01	0.18	3-6

## MECHANICAL PROPERTIES<sup>(1)</sup>

	Yield Strength <sup>(2)</sup> MPa (ksi)	Tensile Strength MPa (ksi)	Elongation %	Charpy V-Notch J (ft·lbf) -196°C (-320°F)	Lateral Expansion mils (mm) -196°C (-320°F)
<b>Typical Results<sup>(3)</sup></b> As-Welded with 98% Ar/2% O <sub>2</sub>	430 (63)	600 (88)	35	34 (47)	24 (0.61)

<sup>(1)</sup>Typical wire composition <sup>(2)</sup>Measured with 0.2% offset <sup>(3)</sup>See test results disclaimer

IMPORTANT: SPECIAL VENTILATION AND/OR EXHAUST REQUIRED

Fumes from the normal use of some welding products can contain significant quantities of components - such as chromium and manganese - which can lower the 5.0 mg/m<sup>3</sup> maximum exposure guideline for general welding fume.

BEFORE USE, READ AND UNDERSTAND THE SAFETY DATA SHEET (SDS) FOR THIS PRODUCT AND SPECIFIC INFORMATION PRINTED ON THE PRODUCT CONTAINER.

# BLUE MAX<sup>®</sup> MIG 309LSi

Stainless ▪ AWS ER309Si, ER309LSi

## KEY FEATURES

- High silicon level for increased puddle fluidity and toe wetting
- Proprietary surface lubricant for steady feeding and arc stability
- Q2 Lot<sup>®</sup> - Certificate showing actual wire composition and calculated ferrite number (FN) available online
- Controlled ferrite content for maximum corrosion resistance
- The same composition as Blue Max<sup>®</sup> MIG 309L with higher silicon content to improve the bead appearance and increase welding ease
- Excellent contour of the weld minimizes the need for grinding

## WELDING POSITIONS

All

## CONFORMANCES

<b>AWS A5:</b>	ER309LSi, ER309Si
<b>ABS:</b>	ER309LSi, ER309Si
<b>CWB/CSA:</b>	ER309LSi, ER309Si
<b>ISO:</b>	S5309LSi

## TYPICAL APPLICATIONS

- Designed for joining stainless steel to mild or low alloy steel
- Exceptionally performs at high wire feed speeds

## SHIELDING GAS

Short Circuiting Transfer:

90% Helium / 7.5% Argon / 2.5% CO<sub>2</sub>

Axial Spray Transfer:

98% Argon/ 2% Oxygen

## DIAMETERS / PACKAGING

Diameter in (mm)	25 lb (11.3 kg) Plastic Spool	500 lb (227 kg) Accu-Trak <sup>®</sup> Drum
0.030 (0.8)	ED023962	
0.035 (0.9)	ED019295	ED029770
0.045 (1.1)	ED019296	ED029771
1/16 (1.6)	ED019297	

## MECHANICAL PROPERTIES<sup>(1)</sup> – As Required per AWS A5.9

	Yield Strength <sup>(2)</sup> MPa (ksi)	Tensile Strength MPa (ksi)	Elongation %	Ferrite Number
<b>Typical Results<sup>(3)</sup> - As-Welded</b>	450 (65)	595 (86)	42	11

<sup>(1)</sup>Typical wire composition. <sup>(2)</sup>Measured with 0.2% offset <sup>(3)</sup>See test results disclaimer

**WIRE COMPOSITION<sup>(1)</sup> – As Required per AWS A5.9**

	%C <sup>(4)</sup>	%Cr	%Ni	%Mo	%Mn
<b>Requirements</b> – AWS ER309LSi	0.03 max	23.0-25.0	12.0- 14.0	0.75 max	1.0-2.5
<b>Typical Results<sup>(3)</sup></b>	0.03	23.5	13.7	0.28	2.0
	%Si	%P	%S	%N <sup>(5)</sup>	%Cu
<b>Requirements</b> – AWS ER309LSi	0.65-1.00	0.03 max	0.03 max	Not Specified	0.75 max
<b>Typical Results<sup>(3)</sup></b>	0.89	0.02	0.01	0.06	0.22

**TYPICAL OPERATING PROCEDURES**

Diameter, Polarity Shielding Gas	CTWD <sup>(6)</sup> mm (in)	Wire Feed Speed m/min (in/min)	Voltage (Volts)	Approx. Current (Amps)	Deposition Rate kg/hr (lb/hr)
-------------------------------------	--------------------------------	-----------------------------------	--------------------	---------------------------	----------------------------------

*Short Circuit Transfer*

<b>0.035 in (0.9 mm), DC+</b> 90% He / 7-1/2% Ar / 2-1/2% CO <sub>2</sub>	13 (1/2)	3.0 (120)	19-20	55	0.9 (2.0)
	13 (1/2)	4.6 (180)	19-20	85	1.4 (3.0)
	13 (1/2)	5.8 (230)	20-21	105	1.8 (3.9)
	13 (1/2)	7.6 (300)	20-21	125	2.3 (5.0)
	13 (1/2)	8.9 (350)	21-22	140	2.7 (5.9)
	13 (1/2)	10.2 (400)	22-23	160	3.1 (6.7)
<b>0.045 in (1.1 mm), DC+</b> 90% He / 7-1/2% Ar / 2-1/2% CO <sub>2</sub>	13 (1/2)	2.5 (100)	19-20	100	1.1 (2.8)
	13 (1/2)	3.2 (125)	19-20	120	1.5 (3.5)
	13 (1/2)	3.8 (150)	21	135	1.7 (4.2)
	13 (1/2)	4.4 (175)	21	140	2.0 (4.8)
	13 (1/2)	5.6 (220)	22	170	2.6 (6.1)
	13 (1/2)	6.4 (250)	22-23	175	2.9 (6.9)
13 (1/2)	7.0 (275)	22-23	185	3.2 (7.6)	

*Axial Spray Transfer*

<b>0.035 in (0.9 mm), DC+</b> 98% Ar/2% O <sub>2</sub>	13 (1/2)	10.2 (400)	22	180	3.1 (6.7)
	13 (1/2)	10.8 (425)	23	190	3.3 (7.1)
	13 (1/2)	11.4 (450)	23	200	3.5 (7.5)
	13 (1/2)	12.1 (475)	23	210	3.7 (8.0)
<b>0.045 in (1.1 mm), DC+</b> 98% Ar/2% O <sub>2</sub>	13 (1/2)	6.1 (240)	23	195	2.8 (6.6)
	13 (1/2)	6.6 (260)	24	230	3.0 (7.2)
	13 (1/2)	7.6 (300)	24	240	3.5 (8.3)
	13 (1/2)	8.3 (325)	25	250	3.8 (9.0)
	13 (1/2)	9.1 (360)	25	260	4.2 (10.0)
<b>1/16 in (1.6 mm), DC+</b> 98% Ar/2% O <sub>2</sub>	19 (3/4)	4.4 (175)	25	260	4.3 (9.2)
	19 (3/4)	5.1 (200)	26	310	4.9 (10.5)
	19 (3/4)	6.4 (250)	26	330	6.2 (13.1)
	19 (3/4)	7.0 (275)	27	360	6.8 (14.4)
	19 (3/4)	7.6 (300)	28	390	7.4 (15.8)

<sup>(1)</sup>Typical wire composition. <sup>(2)</sup>Measured with 0.2% offset <sup>(3)</sup>See test results disclaimer <sup>(4)</sup>AWS Requirement for ER309Si is 0.12% max. carbon. <sup>(5)</sup>Included in 0.50% max. for other elements not specified.<sup>(6)</sup>To estimate ESO, subtract 1/8 in (3 mm) from CTWD.**IMPORTANT: SPECIAL VENTILATION AND/OR EXHAUST REQUIRED**

Fumes from the normal use of some welding products can contain significant quantities of components - such as chromium and manganese - which can lower the 5.0 mg/m<sup>3</sup> maximum exposure guideline for general welding fume.

BEFORE USE, READ AND UNDERSTAND THE SAFETY DATA SHEET (SDS) FOR THIS PRODUCT AND SPECIFIC INFORMATION PRINTED ON THE PRODUCT CONTAINER.



# BLUE MAX<sup>®</sup> MIG 309L

Stainless ▪ AWS ER309L

## KEY FEATURES

- Reduced carbon levels (0.03% max) offer increased resistance to inter-granular corrosion
- Q2 Lot<sup>®</sup> - Certificate showing actual wire composition and calculated ferrite number (FN) available online
- Excellent corrosion resistance

## WELDING POSITIONS

All

## CONFORMANCES

<b>AWS A5:</b>	ER309, ER309L
<b>ABS:</b>	ER309, ER309L
<b>CWB/CSA:</b>	ER309, ER309L

## TYPICAL APPLICATIONS

- Ideal for joining stainless steels to themselves or to carbon or low alloy steels, and can be used at temperatures of up to 700°F (371°C)

## SHIELDING GAS

98% Ar / 2% O

## DIAMETERS / PACKAGING

Diameter in (mm)	33 lb (15 kg) PLW Steel Spool
0.035 (0.9)	ED035071
0.045 (1.1)	ED035072
1/16 (1.6)	ED035074

## WIRE COMPOSITION<sup>(1)</sup> – As Required per AWS A5.9

	%C	%Cr	%Ni	%Mo	%Mn
<b>Requirements</b> AWS ER309L	0.03 max	23.0 - 25.0	12.0 - 14.0	0.75 max	1.0 - 2.5
<b>Typical Results<sup>(2)</sup></b>	0.01	23.4	13.6	0.06	1.6
	%Si	%P	%S	%Cu	FN
<b>Requirements</b> AWS ER309L	0.30 - 0.65	0.03 max	0.03 max	0.75 max	Not Required
<b>Typical Results<sup>(2)</sup></b>	0.38	0.02	0.007	0.07	9 - 14

## TYPICAL OPERATING PROCEDURES

Diameter in (mm)	Voltage (volts)	Amperage	Gas
0.035 (0.9)	26-29	160-210	98/2 (Ar/O <sub>2</sub> )
0.045 (1.1)	28-32	180-250	
1/16 (1.6)	29-33	200-280	

<sup>(1)</sup>Typical wire composition <sup>(2)</sup>See test results disclaimer

### IMPORTANT: SPECIAL VENTILATION AND/OR EXHAUST REQUIRED

Fumes from the normal use of some welding products can contain significant quantities of components - such as chromium and manganese - which can lower the 5.0 mg/m<sup>3</sup> maximum exposure guideline for general welding fume.

BEFORE USE, READ AND UNDERSTAND THE SAFETY DATA SHEET (SDS) FOR THIS PRODUCT AND SPECIFIC INFORMATION PRINTED ON THE PRODUCT CONTAINER.

# BLUE MAX<sup>®</sup> MIG 309LMo\_MOD

Stainless ▪ Similar to AWS ER309LMo

## KEY FEATURES

- Similar to 309L with the exception for the addition of 2.0 - 3.0% molybdenum to increase its pitting corrosion resistance in halide-containing environments
- Surfacing of base metals to improve their resistance to corrosion
- Used to achieve a single-layer overlay with a chemical composition similar to that of a 316L stainless steel

## WELDING POSITIONS

All

## CONFORMANCES

ISO 14343:2009: 23 12 2 L

\* Similar to ER309LMo

## TYPICAL APPLICATIONS

- Used for the first layer of multilayer overlays with filler metals such as 316L or 317L stainless steel

## SHIELDING GAS

98% Ar / 2% O

## DIAMETERS / PACKAGING

Diameter in (mm)	33 lb (15 kg) PLW Steel Spool
0.035 (0.9)	ED035082
0.045 (1.1)	ED035083
1/16 (1.6)	ED035084

## WIRE COMPOSITION<sup>(1)</sup>

	%C	%Cr	%Ni	%Mo	%Mn
<b>Requirements</b> AWS ER309LMo	0.03 max	23.0 - 25.0	12.0 - 14.0	2.0 - 3.0	1.0 - 2.5
<b>Typical Results<sup>(2)</sup></b>	0.01	22.3	15.0	2.6	1.40
	%Si	%P	%S	%Cu	FN
<b>Requirements</b> AWS ER309LMo	0.30 - 0.65	0.03 max	0.03 max	0.75 max	Not Required
<b>Typical Results<sup>(2)</sup></b>	0.40	0.02	0.01	0.10	6 - 12

## TYPICAL OPERATING PROCEDURES

Diameter in (mm)	Voltage (volts)	Amperage	Gas Flow	Gas
0.035 (0.9)	26-29	160-210	30-50 CFH	98% Ar / 2% O <sub>2</sub>
0.045 (1.1)	28-32	180-250	30-50 CFH	
0.062 (1.6)	29-33	200-280	30-50 CFH	

<sup>(1)</sup> Typical wire composition. <sup>(2)</sup> See test results disclaimer

IMPORTANT: SPECIAL VENTILATION AND/OR EXHAUST REQUIRED

Fumes from the normal use of some welding products can contain significant quantities of components - such as chromium and manganese - which can lower the 5.0 mg/m<sup>3</sup> maximum exposure guideline for general welding fume.

BEFORE USE, READ AND UNDERSTAND THE SAFETY DATA SHEET (SDS) FOR THIS PRODUCT AND SPECIFIC INFORMATION PRINTED ON THE PRODUCT CONTAINER.

# BLUE MAX<sup>®</sup> MIG 310

Stainless ▪ AWS ER310

## KEY FEATURES

- Austenitic stainless for high temperature, heat resistant applications
- The weld deposit is fully austenitic, low heat input welding procedures are needed to prevent cracking
- Q2 Lot<sup>®</sup> - Certificate showing actual wire composition

## WELDING POSITIONS

All

## SHIELDING GAS

98% Ar / 2% O

## CONFORMANCES

**AWS A5:** ER310

**ABS:** ER310

## TYPICAL APPLICATIONS

- Heat shields
- Furnace parts
- Ducting
- Welding 310 Stainless and similar materials
- Used for welding stainless steels of similar composition in cast and wrought forms

## DIAMETERS / PACKAGING

Diameter in (mm)	33 lb (15 kg) PLW Steel Spool
0.035 (0.9)	ED035085
0.045 (1.1)	ED035086
1/16 (1.6)	ED035087

## WIRE COMPOSITION<sup>(1)</sup> – As Required per AWS A5.9

	%C	%Cr	%Ni	%Mo	%Mn	%Si	%P	%S	%Cu
<b>Requirements</b> AWS ER310	0.08 - 0.15	25.0 - 28.0	20.0 - 22.5	0.75 max	1.0 - 2.5	0.30 - 0.65	0.03 max	0.03 max	0.75 max
<b>Typical Results<sup>(2)</sup></b>	0.11	27.1	21.0		1.90	0.40	0.01	0.003	0.04

## TYPICAL OPERATING PROCEDURES

Diameter in (mm)	Voltage (volts)	Amperage	Gas Flow	Gas
0.035 (0.9)	26-29	160-210	30-50 CFH	98% Ar / 2% O <sub>2</sub>
0.045 (1.1)	28-32	180-250		
1/16 (1.6)	29-33	200-280		

<sup>(1)</sup>Typical wire composition. <sup>(2)</sup>See test results disclaimer

IMPORTANT: SPECIAL VENTILATION AND/OR EXHAUST REQUIRED

Fumes from the normal use of some welding products can contain significant quantities of components - such as chromium and manganese - which can lower the 5.0 mg/m<sup>3</sup> maximum exposure guideline for general welding fume.

BEFORE USE, READ AND UNDERSTAND THE SAFETY DATA SHEET (SDS) FOR THIS PRODUCT AND SPECIFIC INFORMATION PRINTED ON THE PRODUCT CONTAINER.

# BLUE MAX<sup>®</sup> MIG 312

Stainless ▪ AWS ER312

## KEY FEATURES

- The weld deposits exhibit high tensile strength and offer some resistance to abrasion
- Q2 Lot<sup>®</sup> - Certificate showing actual wire composition and calculated ferrite number (FN) available online
- Applications should be limited to 800°F (420°C)

## WELDING POSITIONS

All

## CONFORMANCES

AWS A5: ER312  
CWB/CSA: ER312

## TYPICAL APPLICATIONS

- Tool steels
- Hard to weld steels
- Cast and wrought alloys
- Dissimilar metals

## SHIELDING GAS

98% Argon / 2% Oxygen

## DIAMETERS / PACKAGING

Diameter in (mm)	33 lb (15 kg) PLW Steel Spool
0.045 (1.1)	ED035088
1/16 (1.6)	ED035089

## WIRE COMPOSITION<sup>(1)</sup> – As Required per AWS A5.9

	%C	%Cr	%Ni	%Mo	%Mn
<b>Requirements</b> AWS ER312	0.15 max	28.0 - 32.0	8.0 - 10.5	0.75 max	1.0 - 2.5
<b>Typical Results<sup>(2)</sup></b>	0.11	29.6	8.9		1.6
	%Si	%P	%S	%Cu	FN
<b>Requirements</b> AWS ER312	0.30 - 0.65	0.03 max	0.03 max	0.75 max	Not Required
<b>Typical Results<sup>(2)</sup></b>	0.44	0.02	0.01	0.10	50 - 80

## TYPICAL OPERATING PROCEDURES

Diameter in (mm)	Voltage (volts)	Amperage	Gas Flow	Gas
0.045 (1.1)	28-32	180-250	30-50 CFH	98% Ar / 2% O <sub>2</sub>
1/16 (1.6)	29-33	200-280		

<sup>(1)</sup>Typical wire composition. <sup>(2)</sup>See test results disclaimer

### IMPORTANT: SPECIAL VENTILATION AND/OR EXHAUST REQUIRED

Fumes from the normal use of some welding products can contain significant quantities of components - such as chromium and manganese - which can lower the 5.0 mg/m<sup>3</sup> maximum exposure guideline for general welding fume.

BEFORE USE, READ AND UNDERSTAND THE SAFETY DATA SHEET (SDS) FOR THIS PRODUCT AND SPECIFIC INFORMATION PRINTED ON THE PRODUCT CONTAINER.

# BLUE MAX<sup>®</sup> MIG 316L

Stainless ▪ AWS ER316L

## KEY FEATURES

- The 2-3% molybdenum improves pitting corrosion resistance of the weld deposit
- Low carbon content reduces the possibility of carbide precipitation and intergranular corrosion
- Q2 Lot<sup>®</sup> - Certificate showing actual wire composition and calculated ferrite number (FN) available online

## WELDING POSITIONS

All

## CONFORMANCES

<b>AWS A5:</b>	ER316, ER316L
<b>ABS:</b>	ER316, ER316L
<b>CWB/CSA:</b>	ER316, ER316L

## TYPICAL APPLICATIONS

- Power Generation
- Chemical and Petrochemical Processing
- Designed for joining 316/316L stainless steels

## SHIELDING GAS

98% Ar / 2% O

## DIAMETERS / PACKAGING

Diameter in (mm)	33 lb (15 kg) PLW Steel Spool	250 lb (113 kg) Accu-Trak <sup>®</sup> Drum
0.030 (0.8)	ED035091	
0.035 (0.9)	ED035092	ED035097
0.045 (1.1)	ED035098	ED035102
1/16 (1.6)	ED035104	

## WIRE COMPOSITION<sup>(1)</sup> – As Required per AWS A5.9/A5.9M:

	%C	%Cr	%Ni	%Mo	%Mn
<b>Requirements</b> AWS ER316L	0.03 max	18.0 - 20.0	11.0 - 14.0	2.0 - 3.0	1.0 - 2.5
<b>Typical Results<sup>(2)</sup></b>	0.01	18.5	12.1	2.4	1.6
	%Si	%P	%S	%Cu	FN
<b>Requirements</b> AWS ER316L	0.30 - 0.65	0.03 max	0.03 max	0.75 max	Not Required
<b>Typical Results<sup>(2)</sup></b>	0.36	0.02	0.01	0.09	6 - 12

## TYPICAL OPERATING PROCEDURES

Diameter in (mm)	Voltage (volts)	Amperage	Gas
0.030 (0.8)	26-29	160-210	98% Ar / 2% O <sub>2</sub>
0.035 (0.9)	26-29	160-210	
0.045 (1.1)	28-32	180-250	
1/16 (1.6)	29-33	200-280	

<sup>(1)</sup>Typical wire composition <sup>(2)</sup>See test results disclaimer

IMPORTANT: SPECIAL VENTILATION AND/OR EXHAUST REQUIRED

Fumes from the normal use of some welding products can contain significant quantities of components - such as chromium and manganese - which can lower the 5.0 mg/m<sup>3</sup> maximum exposure guideline for general welding fume.

BEFORE USE, READ AND UNDERSTAND THE SAFETY DATA SHEET (SDS) FOR THIS PRODUCT AND SPECIFIC INFORMATION PRINTED ON THE PRODUCT CONTAINER.

# BLUE MAX® MIG 316LCF

Stainless ▪ AWS ER316L

## KEY FEATURES

- Controlled Low Ferrite (Range 3-5)
- Charpy V-Notch test results capable of exceeding 27 J (20 ft•lbf) @ -196°C (-320°F)
- Exceeds 15 mils (0.38 mm) of lateral expansion @ -196°C (-320°F)
- Q2 Lot® - Certificates showing actual wire composition available online

## WELDING POSITIONS

All

## CONFORMANCES

AWS A5: ER316 ER316L

## TYPICAL APPLICATIONS

- LNG Storage
- Cryogenic Vessels and Piping

## TYPICAL BASE METALS

- 316L stainless steel

## SHIELDING GAS

98% Ar / 2% O

## DIAMETERS / PACKAGING

Diameter in (mm)	33 lb (15 kg) Steel Spool
0.035 (0.9)	ED034925
0.045 (1.1)	ED034926

## WIRE COMPOSITION<sup>(1)</sup> – As Required per AWS A5.9

	%C	%Cr	%Ni	%Mo	%Mn
<b>Requirements</b> - AWS ER316L	0.03 max	18.0 - 20.0	11.0 - 14.0	2.0 - 3.0	1.0 - 2.5
<b>Typical Results</b> <sup>(3)</sup>	0.01	18.5	12.1	2.4	1.6
	%Si	%P	%S	%Cu	FN
<b>Requirements</b> - AWS ER316L	0.30 - 0.65	0.03 max	0.03 max	0.75 max	Not Required
<b>Typical Results</b> <sup>(3)</sup>	0.36	0.02	0.01	0.09	6 - 12

## MECHANICAL PROPERTIES<sup>(1)</sup>

	Yield Strength <sup>(2)</sup> MPa (ksi)	Tensile Strength MPa (ksi)	Elongation %	Charpy V-Notch J (ft•lbf) -196°C (-320°F)	Lateral Expansion mils (mm) -196°C (-320°F)
<b>Typical Results</b> <sup>(3)</sup> As-Welded with 98% Ar/2% O <sub>2</sub>	410 (69)	580 (85)	36	42 (56)	27 (0.69)

<sup>(1)</sup>Typical wire composition. <sup>(2)</sup>Measured with 0.2% offset <sup>(3)</sup>See test results disclaimer

IMPORTANT: SPECIAL VENTILATION AND/OR EXHAUST REQUIRED

Fumes from the normal use of some welding products can contain significant quantities of components - such as chromium and manganese - which can lower the 5.0 mg/m<sup>3</sup> maximum exposure guideline for general welding fume.

BEFORE USE, READ AND UNDERSTAND THE SAFETY DATA SHEET (SDS) FOR THIS PRODUCT AND SPECIFIC INFORMATION PRINTED ON THE PRODUCT CONTAINER.

# BLUE MAX<sup>®</sup> MIG 316LSI

Stainless ▪ AWS ER316Si, ER316LSi

## KEY FEATURES

- High silicon level for increased puddle fluidity and toe wetting
- Proprietary surface lubricant for steady feeding and arc stability
- Molybdenum grade for increased corrosion resistance
- Q2 Lot<sup>®</sup> - Certificate showing actual wire composition and calculated ferrite number (FN) available online
- Controlled ferrite content for maximum corrosion resistance
- Similar to 316L, with higher silicon content for optimum ease and speed in MIG welding and smooth bead appearance

## WELDING POSITIONS

All

## CONFORMANCES

AWS A5:	ER316LSi, ER316Si
ABS:	ER316LSi, ER316Si
CWB/CSA:	ER316LSi, ER316Si
ISO:	SS316LSi

## TYPICAL APPLICATIONS

- Molybdenum bearing austenitic stainless steels
- Type 316 and 316L
- Exceptionally performs at high wire feed speeds

## SHIELDING GAS

Short Circuiting Transfer:

90% He / 7.5% Argon / 2.5% CO<sub>2</sub>

Axial Spray Transfer:

98% Argon / Balance Oxygen

## DIAMETERS / PACKAGING

Diameter in (mm)	25 lb (11.3 kg) Plastic Spool	250 lb (113 kg) Accu-Trak <sup>®</sup> Drum	500 lb (227 kg) Accu-Trak <sup>®</sup> Drum	500 lb (227 kg) Speed Feed <sup>®</sup> Reel
0.030 (0.8)	ED023963			
0.035 (0.9)	ED019298			
0.045 (1.1)	ED019299	ED035112	ED029772 ED029773	
1/16 (1.6)	ED019300			ED035115

## MECHANICAL PROPERTIES<sup>(1)</sup> – As Required per AWS A5.9

	Yield Strength <sup>(2)</sup> MPa (ksi)	Tensile Strength MPa (ksi)	Elongation %	Ferrite Number
Typical Results <sup>(3)</sup> - As-Welded	405 (59)	560 (81)	40	7

<sup>(1)</sup>Typical wire composition <sup>(2)</sup>Measured with 0.2% offset <sup>(3)</sup>See test results disclaimer

**WIRE COMPOSITION<sup>(1)</sup> – As Required per AWS A5.9**

	%C <sup>(4)</sup>	%Cr	%Ni	%Mo	%Mn
<b>Requirements</b> - AWS ER316LSi	0.03 max	18.0-20.0	11.0- 14.0	2.0-3.0	1.0-2.5
<b>Typical Results<sup>(3)</sup></b>	0.02	18.9	11.8	2.2	2.1
	%Si	%P	%S	%N <sup>(5)</sup>	%Cu
<b>Requirements</b> - AWS ER316LSi	0.65-1.00	0.03 max	0.03 max	Not Specified	0.75 max
<b>Typical Results<sup>(3)</sup></b>	0.81	0.02	0.01	0.05	0.23

**TYPICAL OPERATING PROCEDURES**

Diameter, Polarity Shielding Gas	CTWD <sup>(6)</sup> mm (in)	Wire Feed Speed m/min (in/min)	Voltage (Volts)	Approx. Current (Amps)	Deposition Rate kg/hr (lb/hr)
-------------------------------------	--------------------------------	-----------------------------------	--------------------	---------------------------	----------------------------------

*Short Circuit Transfer*

<b>0.035 in (0.9 mm), DC+</b> 90% He / 7-1/2% Ar / 2-1/2% CO <sub>2</sub>	13 (1/2)	3.0 (120)	19-20	55	0.9 (2.0)
	13 (1/2)	4.6 (180)	19-20	85	1.4 (3.0)
	13 (1/2)	5.8 (230)	20-21	105	1.8 (3.9)
	13 (1/2)	7.6 (300)	20-21	125	2.3 (5.0)
	13 (1/2)	8.9 (350)	21-22	140	2.7 (5.9)
	13 (1/2)	10.2 (400)	22-23	160	3.1 (6.7)
<b>0.045 in (1.1 mm), DC+</b> 90% He / 7-1/2% Ar / 2-1/2% CO <sub>2</sub>	13 (1/2)	2.5 (100)	19-20	100	1.1 (2.8)
	13 (1/2)	3.2 (125)	19-20	120	1.5 (3.5)
	13 (1/2)	3.8 (150)	21	135	1.7 (4.2)
	13 (1/2)	4.4 (175)	21	140	2.0 (4.8)
	13 (1/2)	5.6 (220)	22	170	2.6 (6.1)
	13 (1/2)	6.4 (250)	22-23	175	2.9 (6.9)
13 (1/2)	7.0 (275)	22-23	185	3.2 (7.6)	

*Axial Spray Transfer*

<b>0.035 in (0.9 mm), DC+</b> 98% Ar/2% O <sub>2</sub>	13 (1/2)	10.2 (400)	22	180	3.1 (6.7)
	13 (1/2)	10.8 (425)	23	190	3.3 (7.1)
	13 (1/2)	11.4 (450)	23	200	3.5 (7.5)
	13 (1/2)	12.1 (475)	23	210	3.7 (8.0)
<b>0.045 in (1.1 mm), DC+</b> 98% Ar/2% O <sub>2</sub>	13 (1/2)	6.1 (240)	23	195	2.8 (6.6)
	13 (1/2)	6.6 (260)	24	230	3.0 (7.2)
	13 (1/2)	7.6 (300)	24	240	3.5 (8.3)
	13 (1/2)	8.3 (325)	25	250	3.8 (9.0)
	13 (1/2)	9.1 (360)	25	260	4.2 (10.0)
<b>1/16 in (1.6 mm), DC+</b> 98% Ar/2% O <sub>2</sub>	19 (3/4)	4.4 (175)	25	260	4.3 (9.2)
	19 (3/4)	5.1 (200)	26	310	4.9 (10.5)
	19 (3/4)	6.4 (250)	26	330	6.2 (13.1)
	19 (3/4)	7.0 (275)	27	360	6.8 (14.4)
	19 (3/4)	7.6 (300)	28	390	7.4 (15.8)

<sup>(1)</sup>Typical wire composition. <sup>(2)</sup>Measured with 0.2% offset. <sup>(3)</sup>See test results disclaimer. <sup>(4)</sup>AWS Requirement for ER316Si is 0.12% max. carbon. <sup>(5)</sup>Included in 0.50% max. for other elements not specified.

<sup>(6)</sup>To estimate ESO, subtract 1/8 in (3 mm) from CTWD.

**IMPORTANT: SPECIAL VENTILATION AND/OR EXHAUST REQUIRED**

Fumes from the normal use of some welding products can contain significant quantities of components - such as chromium and manganese - which can lower the 5.0 mg/m<sup>3</sup> maximum exposure guideline for general welding fume.

BEFORE USE, READ AND UNDERSTAND THE SAFETY DATA SHEET (SDS) FOR THIS PRODUCT AND SPECIFIC INFORMATION PRINTED ON THE PRODUCT CONTAINER.



# BLUE MAX<sup>®</sup> MIG 317L

Stainless ▪ AWS ER317L

## KEY FEATURES

- Weld deposit similar to 316L with high molybdenum content for increased corrosion resistance
- Not suitable for structural service above 400°C (752°F) or for cyogenic applications

## WELDING POSITIONS

All

## SHIELDING GAS

98% Ar / 2% O

## CONFORMANCES

AWS A5.9: ER317, ER317L

## TYPICAL APPLICATIONS

- Food Processing
- Chemical Processing Plants
- Condensers
- Petrochemical
- Paper Making
- Designed for welding 317L and alloys with similar composition in high corrosive environments

## DIAMETERS / PACKAGING

Diameter in (mm)	33 lb (15 kg) PLW Steel Spool
0.035 (0.9)	ED035116
0.045 (1.1)	ED035117
1/16 (1.6)	ED035119

## WIRE COMPOSITION<sup>(1)</sup> – As Required per AWS A5.9

	%C	%Cr	%Ni	%Mo	%Mn
<b>Requirements</b> AWS ER317L	0.03 max.	18.5 - 20.5	13.0 - 15.0	3.0 - 4.0	1.0 - 2.5
<b>Typical Results<sup>(2)</sup></b>	0.01	18.9	13.7	3.5	1.4
	%Si	%P	%S	%Cu	
<b>Requirements</b> AWS ER317L	0.30 - 0.65	0.03 max	0.03 max	0.75 max	
<b>Typical Results<sup>(2)</sup></b>	0.45	0.01	0.008	0.08	

## TYPICAL OPERATING PROCEDURES

Diameter in (mm)	Voltage (volts)	Amperage	Gas Flow	Gas
0.035 (0.9)	26-29	160-210	30-50 CFH	98% Ar / 2% O <sub>2</sub>
0.045 (1.1)	28-32	180-250		
1/16 (1.6)	29-33	200-280		

<sup>(1)</sup>Typical wire composition. <sup>(2)</sup>See test results disclaimer

IMPORTANT: SPECIAL VENTILATION AND/OR EXHAUST REQUIRED

Fumes from the normal use of some welding products can contain significant quantities of components - such as chromium and manganese - which can lower the 5.0 mg/m<sup>3</sup> maximum exposure guideline for general welding fume.

BEFORE USE, READ AND UNDERSTAND THE SAFETY DATA SHEET (SDS) FOR THIS PRODUCT AND SPECIFIC INFORMATION PRINTED ON THE PRODUCT CONTAINER.

# BLUE MAX<sup>®</sup> MIG 320LR

Stainless ▪ AWS ER320LR

## KEY FEATURES

- Excellent corrosion resistance
- Q2 Lot<sup>®</sup> - Certificate showing actual wire composition

## WELDING POSITIONS

All

## SHIELDING GAS

98% Ar / 2% O

## CONFORMANCES

AWS A5: ER320LR

## TYPICAL APPLICATIONS

- Process Piping
- Heat Exchangers
- Agitators and rotors
- Chemical processing
- Metal cleaning and pickling industries
- Typically used for welding Alloy 20 base materials and materials in similar composition

## DIAMETERS / PACKAGING

Diameter in (mm)	33 lb (15 kg) PLW Steel Spool
0.035 (0.9)	ED035122
0.045 (1.1)	ED035123
1/16 (1.6)	ED035124

## WIRE COMPOSITION<sup>(1)</sup> – As Required per AWS A5.9

	%C	%Cr	%Ni	%Mo	%Mn
<b>Requirements</b> AWS ER320LR	0.025 max	19.0 - 21.0	32.0 - 36.0	2.0 - 3.0	1.5 - 2.0
<b>Typical Results<sup>(2)</sup></b>	0.003	20.1	33.3	2.4	1.7
	%Si	%P	%S	%Cu	%Nb
<b>Requirements</b> AWS ER320LR	0.15 max	0.015 max	0.02 max	3.0 - 4.0	Required 8 x C / 1.0 max
<b>Typical Results<sup>(2)</sup></b>	0.01	0.010	0.001	3.3	0.22

## TYPICAL OPERATING PROCEDURES

Diameter in (mm)	Voltage (volts)	Amperage	Gas Flow	Gas
0.035 (0.9)	26-29	160-210	30-50 CFH	98% Ar / 2% O <sub>2</sub>
0.045 (1.1)	28-32	180-250		
1/16 (1.6)	29-33	200-280		

<sup>(1)</sup>Typical wire composition. <sup>(2)</sup>See test results disclaimer.

### IMPORTANT: SPECIAL VENTILATION AND/OR EXHAUST REQUIRED

Fumes from the normal use of some welding products can contain significant quantities of components - such as chromium and manganese - which can lower the 5.0 mg/m<sup>3</sup> maximum exposure guideline for general welding fume.

BEFORE USE, READ AND UNDERSTAND THE SAFETY DATA SHEET (SDS) FOR THIS PRODUCT AND SPECIFIC INFORMATION PRINTED ON THE PRODUCT CONTAINER.

# BLUE MAX<sup>®</sup> MIG 330

Stainless ▪ AWS ER330

## KEY FEATURES

- High sulfur environments adversely affect the high temperature performance
- Heat input must be kept at a minimum during welding to avoid possible micro-fissuring
- Q2 Lot<sup>®</sup> - Certificate showing actual wire composition

## WELDING POSITIONS

All

## SHIELDING GAS

98% Ar / 2% O

## DIAMETERS / PACKAGING

Diameter in (mm)	33 lb (15 kg) PLW Steel Spool
0.035 (0.9)	ED035125
0.045 (1.1)	ED035127

## WIRE COMPOSITION<sup>(1)</sup> – As Required per AWS A5.9

	%C	%Cr	%Ni	%Mo	%Mn
<b>Requirements</b> AWS ER330	0.18 - 0.25	15.0 - 17.0	34.0 - 37.0	0.75 max	1.0 - 2.5
<b>Typical Results<sup>(2)</sup></b>	0.23	15.9	35.2		1.9
	%Si	%P	%S	%Cu	
<b>Requirements</b> AWS ER330	0.30 - 0.65	0.03	0.03	0.75 max	
<b>Typical Results<sup>(2)</sup></b>	0.42	0.01	0.005	0.10	

## TYPICAL OPERATING PROCEDURES

Diameter in (mm)	Voltage (volts)	Amperage	Gas Flow	Gas
0.035 (0.9)	26-29	160-210	30-50 CFH	98% Ar / 2% O <sub>2</sub>
0.045 (1.1)	28-32	180-250		

<sup>(1)</sup>Typical wire composition. <sup>(2)</sup>See test results disclaimer.

### IMPORTANT: SPECIAL VENTILATION AND/OR EXHAUST REQUIRED

Fumes from the normal use of some welding products can contain significant quantities of components - such as chromium and manganese - which can lower the 5.0 mg/m<sup>3</sup> maximum exposure guideline for general welding fume.

BEFORE USE, READ AND UNDERSTAND THE SAFETY DATA SHEET (SDS) FOR THIS PRODUCT AND SPECIFIC INFORMATION PRINTED ON THE PRODUCT CONTAINER.

# BLUE MAX<sup>®</sup> MIG 347

Stainless ▪ AWS ER347

## KEY FEATURES

- The addition of niobium reduces intergranular corrosion in severe operating conditions
- Q2 Lot<sup>®</sup> - Certificate showing actual chemistry available online

## WELDING POSITIONS

All

## SHIELDING GAS

98% Ar / 2% O

## CONFORMANCES

AWS A5: ER347

ABS: ER347

## TYPICAL APPLICATIONS

- High temperature stainless applications
- Pharmaceutical Equipment
- Welding 321 and 347 type stainless and stainless clad steels
- Food Processing

## DIAMETERS / PACKAGING

Diameter in (mm)	33 lb (15 kg) PLW Steel Spool	500 lb (227 kg) Speed Feed <sup>®</sup> Reel
0.035 (0.9)	ED035128	
0.045 (1.1)	ED035130	
1/16 (1.6)	ED035132	ED035133

## WIRE COMPOSITION<sup>(1)</sup> – As Required per AWS A5.9

	%C	%Cr	%Ni	%Mo	%Nb + Ta
<b>Requirements</b> AWS ER347	0.08 max	19.0 - 21.5	9.0 - 11.0	0.75 max	10 x C - 1.0
<b>Typical Results<sup>(2)</sup></b>	0.03	19.5	9.3	0.25	0.60
	%Mn	%Si	%P	%S	%Cu
<b>Requirements</b> AWS ER347	1.0 - 2.5	0.30 - 0.65	0.03 max	0.03 max	0.75 max
<b>Typical Results<sup>(2)</sup></b>	1.7	0.45	0.01	0.007	0.10

## TYPICAL OPERATING PROCEDURES

Diameter in (mm)	Voltage (volts)	Amperage	Gas Flow	Gas
0.035 (0.9)	26-29	160-210	30-50 CFH	98% Ar / 2% O <sub>2</sub>
0.045 (1.1)	28-32	180-250		
1/16 (1.6)	29-33	200-280		

<sup>(1)</sup>Typical wire composition. <sup>(2)</sup>See test results disclaimer

IMPORTANT: SPECIAL VENTILATION AND/OR EXHAUST REQUIRED

Fumes from the normal use of some welding products can contain significant quantities of components - such as chromium and manganese - which can lower the 5.0 mg/m<sup>3</sup> maximum exposure guideline for general welding fume.

BEFORE USE, READ AND UNDERSTAND THE SAFETY DATA SHEET (SDS) FOR THIS PRODUCT AND SPECIFIC INFORMATION PRINTED ON THE PRODUCT CONTAINER.

# BLUE MAX<sup>®</sup> MIG 385

Stainless ▪ AWS ER385

## KEY FEATURES

- Super austenitic stainless steel provides resistance to stress corrosion cracking
- Q2 Lot<sup>®</sup> Certificate showing actual chemistry available online
- Low heat input procedures needed

## WELDING POSITIONS

All

## SHIELDING GAS

98% Ar / 2% O

## CONFORMANCES

AWS A5: ER385

CWB/CSA: ER385

## TYPICAL APPLICATIONS

- Used for welding 904L stainless steel
- Used in fabrication of equipment and vessels for handling and storage of sulfuric acid, phosphoric acid, and other inorganic and organic acids
- Process piping

## DIAMETERS / PACKAGING

Diameter in (mm)	33 lb (15 kg) PLW Steel Spool
0.035 (0.9)	ED035134
0.045 (1.1)	ED035135
1/16 (1.6)	ED035136

## WIRE COMPOSITION<sup>(1)</sup> – As Required per AWS A5.9

	%C	%Cr	%Ni	%Mo	%Mn
<b>Requirements</b> AWS ER385	0.025 max	19.5 - 21.5	24.0 - 26.0	4.2 - 5.2	1.0 - 2.5
<b>Typical Results<sup>(2)</sup></b>	0.010	19.9	25.0	4.2	1.8
	%Si	%P	%S	%Cu	
<b>Requirements</b> AWS ER385	0.50 max	0.02 max	0.03 max	1.2 - 2.0	
<b>Typical Results<sup>(2)</sup></b>	0.3	0.01	0.001	1.4	

## TYPICAL OPERATING PROCEDURES

Diameter in (mm)	Voltage (volts)	Amperage	Gas Flow	Gas
0.035 (0.9)	26-29	160-210	30-50 CFH	98% Ar / 2% O <sub>2</sub>
0.045 (1.1)	28-32	180-250		
1/16 (1.6)	29-33	200-280		

<sup>(1)</sup>Typical wire composition. <sup>(2)</sup>See test results disclaimer

### IMPORTANT: SPECIAL VENTILATION AND/OR EXHAUST REQUIRED

Fumes from the normal use of some welding products can contain significant quantities of components - such as chromium and manganese - which can lower the 5.0 mg/m<sup>3</sup> maximum exposure guideline for general welding fume.

BEFORE USE, READ AND UNDERSTAND THE SAFETY DATA SHEET (SDS) FOR THIS PRODUCT AND SPECIFIC INFORMATION PRINTED ON THE PRODUCT CONTAINER.

# BLUE MAX<sup>®</sup> MIG 409Nb

Stainless ▪ AWS ER409Nb

## KEY FEATURES

- A ferritic stainless steel
- The addition of niobium improves corrosion resistance and promotes a ferritic micro-structure
- For the best results, welding must be done in a low heat input procedure not recommended for multi-pass applications
- Q2 Lot<sup>®</sup> - Certificate showing actual chemistry available online

## WELDING POSITIONS

All

## CONFORMANCES

AWS A5: ER409Nb

## TYPICAL APPLICATIONS

- Automotive Exhausts
- Catalytic Converters under typical applications
- Designed to weld type 409 and 409Ti base materials

## SHIELDING GAS

98% Ar / 2% O

90% Helium / 7.5% Argon / 2.5% Carbon Dioxide

## DIAMETERS / PACKAGING

Diameter in (mm)	33 lb (15 kg) PLW Steel Spool
0.035 (0.9)	ED035137
0.045 (1.1)	ED035138

## WIRE COMPOSITION<sup>(1)</sup> – As Required per AWS A5.9

	%C	%Cr	%Ni	%Mo	%Nb
<b>Requirements</b> AWS ER409Nb	0.08 max	10.5 - 13.5	0.6 max	0.50 max	0.075 max
<b>Typical Results<sup>(2)</sup></b>	0.04	11.5	0.4	0.03	0.50
	%Mn	%Si	%P	%S	%Cu
<b>Requirements</b> AWS ER409Nb	0.8 max	1.0 max	0.04 max	0.03 max	0.75 max
<b>Typical Results<sup>(2)</sup></b>	0.62	0.48	0.02	0.02	0.04

## TYPICAL OPERATING PROCEDURES

Diameter in (mm)	Voltage (volts)	Amperage	Gas Flow	Gas
0.035 (0.9)	26-29	160-210	30-50 CFH	98% Ar / 2% O <sub>2</sub>
0.045 (1.1)	28-32	180-250		

<sup>(1)</sup>Typical wire composition. <sup>(2)</sup>See test results disclaimer

IMPORTANT: SPECIAL VENTILATION AND/OR EXHAUST REQUIRED

Fumes from the normal use of some welding products can contain significant quantities of components - such as chromium and manganese - which can lower the 5.0 mg/m<sup>3</sup> maximum exposure guideline for general welding fume.

BEFORE USE, READ AND UNDERSTAND THE SAFETY DATA SHEET (SDS) FOR THIS PRODUCT AND SPECIFIC INFORMATION PRINTED ON THE PRODUCT CONTAINER.

# BLUE MAX<sup>®</sup> MIG 410

Stainless ▪ AWS ER410

## KEY FEATURES

- Designed to weld stainless steels of similar chemical composition as well as to overlay carbon steels to impart corrosion, erosion and abrasion resistance
- Preheat and inter-pass temperature of 400°F (200°C) or greater are recommended during welding
- Q2 Lot<sup>®</sup> Certificate showing actual wire composition is recommended available online

## WELDING POSITIONS

All

## CONFORMANCES

AWS A5: ER410

## TYPICAL APPLICATIONS

- Surfacing Steel Mill Rolls
- Furnace and Burner Parts
- Turbine Parts

## SHIELDING GAS

98% Ar / 2% O  
90% Helium / 7.5% Argon / 2.5% Carbon Dioxide

## DIAMETERS / PACKAGING

Diameter in (mm)	33 lb (15 kg) PLW Steel Spool	500 lb (227 kg) Speed Feed <sup>®</sup> Reel	1000 lb (454 kg) Speed Feed <sup>®</sup> Reel
0.035 (0.9)	ED035139	ED035141	ED035142
0.045 (1.1)	ED035140		
1/16 (1.6)	ED035143		

## WIRE COMPOSITION<sup>(1)</sup> – As Required per AWS A5.9

	%C	%Cr	%Ni	%Mo	%Mn
<b>Requirements</b> AWS ER410	0.12 max	11.5 - 13.5	0.6 max	0.75 max	0.6 max
<b>Typical Results<sup>(2)</sup></b>	0.11	12.5	0.1	0.03	0.45
	%Si	%P	%S	%Cu	
<b>Requirements</b> AWS ER410	0.5 max	0.03 max	0.03 max	0.75 max	
<b>Typical Results<sup>(2)</sup></b>	0.39	0.01	0.01	0.14	

## TYPICAL OPERATING PROCEDURES

Diameter in (mm)	Voltage (volts)	Amperage	Gas Flow	Gas
0.035 (0.9)	26-29	160-210	30-50 CFH	98% Ar / 2% O <sub>2</sub>
0.045 (1.1)	28-32	180-250		

<sup>(1)</sup>Typical wire composition. <sup>(2)</sup>See test results disclaimer

### IMPORTANT: SPECIAL VENTILATION AND/OR EXHAUST REQUIRED

Fumes from the normal use of some welding products can contain significant quantities of components - such as chromium and manganese - which can lower the 5.0 mg/m<sup>3</sup> maximum exposure guideline for general welding fume.

BEFORE USE, READ AND UNDERSTAND THE SAFETY DATA SHEET (SDS) FOR THIS PRODUCT AND SPECIFIC INFORMATION PRINTED ON THE PRODUCT CONTAINER.

# BLUE MAX<sup>®</sup> MIG 410NiMo

Stainless ▪ AWS ER410NiMo

## KEY FEATURES

- Used to overlay mild and low alloy steels
- Preheat and inter-pass temperature of 300°F (150°C) or greater are recommended during welding
- Post-weld heat treatment should not exceed 1150°F (620°C) as higher temperatures may result in hardening
- Q2 Lot<sup>®</sup> - Certificate showing actual chemistry available online

## WELDING POSITIONS

All

## CONFORMANCES

AWS A5: ER410NiMo

## TYPICAL APPLICATIONS

- Turbines
- Valve Bodies
- Power Generation
- Chemical & Petrochemical
- High Pressure Piping
- Designed to weld materials of similar chemical composition in cast and wrought forms

## SHIELDING GAS

98% Ar / 2% O  
90% Helium / 7.5% Argon / 2.5% Carbon Dioxide

## DIAMETERS / PACKAGING

Diameter in (mm)	33 lb (15 kg) PLW Steel Spool
0.035 (0.9)	ED035144
0.045 (1.1)	ED035145

## WIRE COMPOSITION<sup>(1)</sup> – As Required per AWS A5.9

	%C	%Cr	%Ni	%Mo	%Mn
<b>Requirements</b> AWS ER410NiMo	0.06 max	11.0 - 12.5	4.0 - 5.0	0.4 - 0.7	0.6 max
<b>Typical Results<sup>(2)</sup></b>	0.02	11.7	4.7	0.5	0.2
	%Si	%P	%S	%Cu	
<b>Requirements</b> AWS ER410NiMo	0.5 max	0.03 max	0.03 max	0.75 max	
<b>Typical Results<sup>(2)</sup></b>	0.2	0.01	0.002	0.06	

## TYPICAL OPERATING PROCEDURES

Diameter in (mm)	Voltage (volts)	Amperage	Gas Flow	Gas
0.035 (0.9)	26-29	160-210	30-50 CFH	98% Ar / 2% O <sub>2</sub>
0.045 (1.1)	28-32	180-250		

<sup>(1)</sup>Typical wire composition. <sup>(2)</sup>See test results disclaimer

IMPORTANT: SPECIAL VENTILATION AND/OR EXHAUST REQUIRED

Fumes from the normal use of some welding products can contain significant quantities of components - such as chromium and manganese - which can lower the 5.0 mg/m<sup>3</sup> maximum exposure guideline for general welding fume.

BEFORE USE, READ AND UNDERSTAND THE SAFETY DATA SHEET (SDS) FOR THIS PRODUCT AND SPECIFIC INFORMATION PRINTED ON THE PRODUCT CONTAINER.



# BLUE MAX<sup>®</sup> MIG 420

Stainless ▪ AWS ER420

## KEY FEATURES

- Higher hardness levels than Blue Max 410, due to higher carbon & Chromium content
- Intended to weld stainless steels similar in chemical composition
- Q2 Lot<sup>®</sup> - Certificate showing actual wire composition and calculated ferrite number (FN) available online

## WELDING POSITIONS

All

## SHIELDING GAS

98% Ar / 2% O

## CONFORMANCES

AWS A5: ER420

## TYPICAL APPLICATIONS

- Hydraulic Equipment Components
- Impellers
- Pump Shafts

## DIAMETERS / PACKAGING

Diameter in (mm)	33 lb (15 kg) PLW Steel Spool
1/16 (1.6)	ED035146

## WIRE COMPOSITION<sup>(1)</sup> – As Required per AWS A5.9

	%C	%Mn	%Si	%S	%P
<b>Requirements</b> AWS ER420	0.25-0.40	0.60	0.50	0.03	0.03
<b>Typical Results<sup>(2)</sup></b>	0.32	0.30	0.30	0.01	0.02
	%Cr	%Ni	%Mo	%Cu	
<b>Requirements</b> AWS ER420	12.0-14.0	0.60	0.75	0.75	
<b>Typical Results<sup>(2)</sup></b>	13.20	0.20	0.03	0.02	

## TYPICAL OPERATING PROCEDURES

Process	Diameter in (mm)	Voltage (volts)	Amperage	Gas Flow	Gas
MIG (DCEP)	1/16 (1.6)	29-33	200-280	30-50 CFH	98% Ar / 2% O <sub>2</sub>

<sup>(1)</sup>Typical wire composition. <sup>(2)</sup>See test results disclaimer

IMPORTANT: SPECIAL VENTILATION AND/OR EXHAUST REQUIRED

Fumes from the normal use of some welding products can contain significant quantities of components - such as chromium and manganese - which can lower the 5.0 mg/m<sup>3</sup> maximum exposure guideline for general welding fume.

BEFORE USE, READ AND UNDERSTAND THE SAFETY DATA SHEET (SDS) FOR THIS PRODUCT AND SPECIFIC INFORMATION PRINTED ON THE PRODUCT CONTAINER.

# BLUE MAX<sup>®</sup> MIG 630

Stainless ▪ AWS ER630

## KEY FEATURES

- Heat treatment of material will obtain higher strength, and greatly influence mechanical properties
- Q2 Lot<sup>®</sup> Certificate showing actual wire composition and calculated ferrite number (FN) available online
- Precipitation hardening, martensitic stainless steel

## WELDING POSITIONS

All

## CONFORMANCES

AWS A5: ER630

## TYPICAL APPLICATIONS

- Hydraulic Equipment Components
- Impellers
- Pump Shafts
- Welding 17-4 PH stainless steels

## SHIELDING GAS

98% Ar / 2% O

## DIAMETERS / PACKAGING

Diameter in (mm)	33 lb (15 kg) PLW Steel Spool
0.035 (0.9)	ED035150
0.045 (1.1)	ED035151
1/16 (1.6)	ED035153

## WIRE COMPOSITION<sup>(1)</sup> – As Required per AWS A5.9

	%C	%Cr	%Ni	%Mo	%Nb
<b>Requirements</b> AWS ER630	0.05 max	16.00 - 16.75	4.5 - 5.0	0.75 max	0.15 - 0.30
<b>Typical Results<sup>(2)</sup></b>	0.03	16.5	4.8	0.2	0.22
	%Mn	%Si	%P	%S	%Cu
<b>Requirements</b> AWS ER630	0.25 - 0.75	0.75 max	0.03 max	0.03 max	3.25 - 4.0
<b>Typical Results<sup>(2)</sup></b>	0.54	0.43	0.02	0.02	3.6

## TYPICAL OPERATING PROCEDURES

Diameter in (mm)	Voltage (volts)	Amperage	Gas Flow	Gas
0.035 (0.9)	26-29	160-210	30-50 CFH	98% Argon / 2% CO <sub>2</sub>
0.045 (1.1)	28-32	180-250		

<sup>(1)</sup>Typical wire composition. <sup>(2)</sup>See test results disclaimer

IMPORTANT: SPECIAL VENTILATION AND/OR EXHAUST REQUIRED

Fumes from the normal use of some welding products can contain significant quantities of components - such as chromium and manganese - which can lower the 5.0 mg/m<sup>3</sup> maximum exposure guideline for general welding fume.

BEFORE USE, READ AND UNDERSTAND THE SAFETY DATA SHEET (SDS) FOR THIS PRODUCT AND SPECIFIC INFORMATION PRINTED ON THE PRODUCT CONTAINER.

# BLUE MAX<sup>®</sup> MIG 2209

Stainless ▪ AWS ER2209

## KEY FEATURES

- The welds offer excellent resistance to stress corrosion, cracking and pitting
- The microstructure of the weld metal consists of austenite and ferrite
- Q2 Lot<sup>®</sup> Certificate showing actual wire composition and calculated ferrite number (FN) available online

## WELDING POSITIONS

All

## SHIELDING GAS

98% Ar / 2% O

## CONFORMANCES

AWS A5: ER2209

ABS: ER2209

## TYPICAL APPLICATIONS

- Offshore
- Oil and Gas
- Chemical
- Petrochemical
- Welding 2205 duplex stainless steel

## DIAMETERS / PACKAGING

Diameter in (mm)	33 lb (15 kg) PLW Steel Spool
0.030 (0.8)	ED035023
0.035 (0.9)	ED035025
0.045 (1.1)	ED035027
1/16 (1.6)	ED035028

## WIRE COMPOSITION<sup>(1)</sup> – As Required per AWS A5.9

	%C	%Cr	%Ni	%Mo	%Mn	%Si
<b>Requirements</b> AWS ER2209	0.03 max	21.5 - 23.5	7.5 - 9.5	2.5 - 3.5	0.5 - 2.0	0.90 max
<b>Typical Results<sup>(2)</sup></b>	0.01	22.7	8.5	3.0	1.4	0.4
	%P	%S	%N	%Cu	FN	
<b>Requirements</b> AWS ER2209	0.03 max	0.03 max	0.08 - 0.20	0.75 max	Not Required	
<b>Typical Results<sup>(2)</sup></b>	0.01	0.001	0.15	0.06	30 - 60	

## TYPICAL OPERATING PROCEDURES

Diameter in (mm)	Voltage (volts)	Amperage	Gas Flow	Gas
0.035 (0.9)	26-29	160-210	30-50 CFH	98% Argon/ 2% Carbon Dioxide
0.045 (1.1)	28-32	180-250		
1/16 (1.6)	29-33	200-280		

<sup>(1)</sup>Typical wire composition. <sup>(2)</sup>See test results disclaimer

### IMPORTANT: SPECIAL VENTILATION AND/OR EXHAUST REQUIRED

Fumes from the normal use of some welding products can contain significant quantities of components - such as chromium and manganese - which can lower the 5.0 mg/m<sup>3</sup> maximum exposure guideline for general welding fume.

BEFORE USE, READ AND UNDERSTAND THE SAFETY DATA SHEET (SDS) FOR THIS PRODUCT AND SPECIFIC INFORMATION PRINTED ON THE PRODUCT CONTAINER.

# BLUE MAX® MIG 2594

Stainless ▪ AWS ER2594

## KEY FEATURES

- A super-duplex grade electrode that provides matching chemistry and mechanical property characteristics to wrought super-duplex alloys such as 2507 and Zeron 100, as well as to super-duplex casting alloys (ATSM A890)
- The electrode is over-alloyed 2-3% in nickel to provide the optimum ferrite/austenite ratio in the finished weld resulting in high tensile and yield strength and superior resistance to stress corrosion, cracking (SCC) and pitting corrosion
- Q2 Lot® - Certificate showing actual wire composition and calculated ferrite number (FN) available online

## WELDING POSITIONS

All

## CONFORMANCES

**AWS A5:** ER2594

**ABS:** ER2594

## TYPICAL APPLICATIONS

- Process Pipework
- Pumps and Valves
- Pressure Vessels
- Welding Zeron 100% and similar base metals

## SHIELDING GAS

98% Ar / 2% O

## DIAMETERS / PACKAGING

Diameter in (mm)	33 lb (15 kg) PLW Steel Spool
0.035 (0.9)	ED035029
0.045 (1.1)	ED035030

## WIRE COMPOSITION<sup>(1)</sup> – As Required per AWS A5.9

	%C	%Cr	%Ni	%Mo	%Mn	%Si
<b>Requirements</b> AWS ER2594	0.03 max	24.0 - 27.0	8.0 - 10.5	2.5 - 4.5	2.5 max	1.0 max
<b>Typical Results<sup>(2)</sup></b>	0.02	24.6	8.6	3.8	0.8	0.3
	%P	%S	%N	%Cu	%W	FN
<b>Requirements</b> AWS ER2594	0.03 max	0.02 max	0.20 - 0.30	1.5 max	1.00 max	Not Required
<b>Typical Results<sup>(2)</sup></b>	0.02	0.01	0.25	0.01	0.01	30 - 60

## TYPICAL OPERATING PROCEDURES

Diameter in (mm)	Voltage (volts)	Amperage	Gas Flow	Gas
0.035 (0.9) 0.045 (1.1)	26-29 28-32	160-210 180-250	30-50 CFH	Argon + 2-5% CO <sub>2</sub>

<sup>(1)</sup>Typical wire composition. <sup>(2)</sup>See test results disclaimer

IMPORTANT: SPECIAL VENTILATION AND/OR EXHAUST REQUIRED

Fumes from the normal use of some welding products can contain significant quantities of components - such as chromium and manganese - which can lower the 5.0 mg/m<sup>3</sup> maximum exposure guideline for general welding fume.

BEFORE USE, READ AND UNDERSTAND THE SAFETY DATA SHEET (SDS) FOR THIS PRODUCT AND SPECIFIC INFORMATION PRINTED ON THE PRODUCT CONTAINER.

# LINCOLN® RED MAX® 308LSi

Stainless ▪ AWS ER308Si, ER308LSi

## KEY FEATURES

- Engineered surface treatment for weldability control in semiautomatic applications
- High silicon level for increased puddle fluidity and toe wetting
- Q2 Lot® - Certificate showing actual wire composition and calculated ferrite number (FN) available online

## WELDING POSITIONS

All

## SHIELDING GAS

Short Circuiting Transfer:

90% He/ 7.5% Ar/ 2.5% CO<sub>2</sub>

Axial Spray Transfer:

98% Argon/ Balance O<sub>2</sub> or CO<sub>2</sub>

## CONFORMANCES

**AWS A5:** ER308LSi, ER308Si

**ABS:** ER308LSi, ER308Si

**ABS:** SS308LSi, SS308Si

## TYPICAL APPLICATIONS

- Semiautomatic welding
- 304 and 304L stainless steel
- Common austenitic stainless steels referred to as "18-8" steels
- ASTM A743 or A744 Types CF-8 and CF-3

## DIAMETERS / PACKAGING

Diameter in (mm)	33 lb (15 kg) Steel Spool	500 lb (227 kg) Accu-Trak® Drum	500 lb (227 kg) Accu-Pak® Box
0.035 (0.9)	ED036760	ED036895	ED036924
0.045 (1.1)	ED036761	ED036896	ED036925
1/16 (1.6)	ED036762	ED036897	ED036926

## MECHANICAL PROPERTIES<sup>(1)</sup> – As Required per AWS A5.9

	Yield Strength <sup>(2)</sup> MPa (ksi)	Tensile Strength MPa (ksi)	Elongation %	Ferrite Number
<b>Requirements</b> - AWS ER308Si, ER308LSi	Not Specified			
<b>Typical Results<sup>(3)</sup></b> - As-Welded	455 (66)	635 (92)	46	10

## WIRE COMPOSITION<sup>(1)</sup> – As Required per AWS A5.9

	%C <sup>(4)</sup>	%Cr	%Ni	%Mo	%Mn
<b>Requirements</b> - AWS ER308Si, ER308LSi	0.03 max	19.5-22.0	9.0- 11.0	0.75 max	1.0-2.5
<b>Typical Results<sup>(3)</sup></b>	0.01	19.9	10.0	0.16	2.1
	%Si	%P	%S	%N <sup>(5)</sup>	%Cu
<b>Requirements</b> - AWS ER308Si, ER308LSi	0.65-1.00	0.03 max	0.03 max	Not Specified	0.75 max
<b>Typical Results<sup>(3)</sup></b>	0.88	0.02	0.01	0.05	0.17

<sup>(1)</sup>Typical all weld metal. <sup>(2)</sup>Measured with 0.2% offset. <sup>(3)</sup>See test results disclaimer. <sup>(4)</sup>AWS Requirement for ER308Si is 0.08% max carbon. <sup>(5)</sup>Included in 0.50% max. for other elements not specified.

## TYPICAL OPERATING PROCEDURES

Diameter, Polarity Shielding Gas	CTWD <sup>(6)</sup> mm (in)	Wire Feed Speed m/min (in/min)	Voltage (Volts)	Approx. Current (Amps)	Deposition Rate kg/hr (lb/hr)
<i>Short Circuit Transfer</i>					
<b>0.035 in (0.9 mm), DC+</b> 90% He / 7.5% Ar / 2.5% CO <sub>2</sub>	13 (1/2)	3.0 (120)	20-21	60	0.9 (2.0)
	13 (1/2)	4.6 (180)	21-23	90	1.4 (3.0)
	13 (1/2)	5.8 (230)	22-24	105	1.8 (3.9)
	13 (1/2)	7.6 (300)	23-25	130	2.3 (5.0)
	13 (1/2)	8.9 (350)	24-26	145	2.7 (5.9)
	13 (1/2)	10.2 (400)	25-27	155	3.1 (6.7)
<b>0.045 in (1.1 mm), DC+</b> 90% He / 7.5% Ar / 2.5% CO <sub>2</sub>	13 (1/2)	2.5 (100)	20-21	80	1.1 (2.8)
	13 (1/2)	3.2 (125)	21-22	110	1.5 (3.5)
	13 (1/2)	3.8 (150)	21-23	130	1.7 (4.2)
	13 (1/2)	4.4 (175)	22-24	145	2.0 (4.8)
	13 (1/2)	5.6 (220)	23-25	170	2.6 (6.1)
	13 (1/2)	6.4 (250)	24-26	180	2.9 (6.9)
13 (1/2)	7.0 (275)	25-27	190	3.2 (7.6)	
<i>Axial Spray Transfer</i>					
<b>0.035 in (0.9 mm), DC+</b> 98% Ar / 2% O <sub>2</sub>	13 (1/2)	10.2 (400)	23-24	190	3.1 (6.7)
	13 (1/2)	10.8 (425)	24-25	200	3.3 (7.1)
	13 (1/2)	11.4 (450)	24-25	210	3.5 (7.5)
	13 (1/2)	12.1 (475)	25-26	220	3.7 (8.0)
<b>0.045 in (1.1 mm), DC+</b> 98% Ar / 2% O <sub>2</sub>	13 (1/2)	6.1 (240)	22-24	195	2.8 (6.6)
	13 (1/2)	6.6 (260)	23-25	215	3.0 (7.2)
	13 (1/2)	7.6 (300)	24-26	245	3.5 (8.3)
	13 (1/2)	8.3 (325)	25-27	250	3.8 (9.0)
	13 (1/2)	9.1 (360)	25-27	275	4.2 (10.0)

<sup>(1)</sup>Typical all weld metal. <sup>(2)</sup>Measured with 0.2% offset. <sup>(3)</sup>See test results disclaimer. <sup>(4)</sup>AWS Requirement for ER308Si is 0.08% max carbon. <sup>(5)</sup>Included in 0.50% max. for other elements not specified. <sup>(6)</sup>To estimate ESO, subtract 1/8 in (3.2 mm) from CTWD.

## IMPORTANT: SPECIAL VENTILATION AND/OR EXHAUST REQUIRED

Fumes from the normal use of some welding products can contain significant quantities of components - such as chromium and manganese - which can lower the 5.0 mg/m<sup>3</sup> maximum exposure guideline for general welding fume.

BEFORE USE, READ AND UNDERSTAND THE SAFETY DATA SHEET (SDS) FOR THIS PRODUCT AND SPECIFIC INFORMATION PRINTED ON THE PRODUCT CONTAINER.

# LINCOLN® RED MAX® 309LSI

Stainless ▪ AWS ER309Si, ER309LSi

## KEY FEATURES

- Engineered surface treatment for weldability control in semiautomatic applications
- High silicon level for increased puddle fluidity and toe wetting
- Q2 Lot® - Certificate showing actual wire composition and calculated ferrite number (FN) available online

## WELDING POSITIONS

All

## SHIELDING GAS

Short Circuiting Transfer:

90% He/ 7.5% Ar/ 2.5% CO<sub>2</sub>

Axial Spray Transfer:

98% Argon/ Balance O<sub>2</sub> or CO<sub>2</sub>

## CONFORMANCES

**AWS A5:** ER309LSi, ER309Si

**ABS:** ER309LSi, ER309Si

**ABS:** SS309LSi, SS309Si

## TYPICAL APPLICATIONS

- Semiautomatic welding
- Designed for joining stainless steel to mild steel or low alloy steel

## DIAMETERS / PACKAGING

Diameter in (mm)	33 lb (15 kg) Steel Spool	500 lb (227 kg) Accu-Trak® Drum	500 lb (227 kg) Accu-Pak® Box
0.035 (0.9)	ED036763	ED036971	ED036927
0.045 (1.1)	ED036764	ED036972	ED036928
1/16 (1.6)	ED036765	ED036973	ED036929

## MECHANICAL PROPERTIES<sup>(1)</sup> – As Required per AWS A5.9

	Yield Strength <sup>(2)</sup> MPa (ksi)	Tensile Strength MPa (ksi)	Elongation %	Ferrite Number
<b>Requirements</b> - AWS ER309Si, ER309LSi	Not Specified			
<b>Typical Results<sup>(3)</sup></b> - As-Welded	450 (65)	595 (86)	42	11

## WIRE COMPOSITION<sup>(1)</sup> – As Required per AWS A5.9

	%C <sup>(4)</sup>	%Cr	%Ni	%Mo	%Mn
<b>Requirements</b> - AWS ER309Si, ER309LSi	0.03 max	23.0-25.0	12.0-14.0	0.75 max	1.0-2.5
<b>Typical Results<sup>(3)</sup></b> - As-Welded	0.03	23.5	13.7	0.28	2.0
	%Si	%P	%S	%N <sup>(5)</sup>	%Cu
<b>Requirements</b> - AWS ER309Si, ER309LSi	0.65-1.00	0.03 max	0.03 max	Not Specified	0.75 max
<b>Typical Results<sup>(3)</sup></b> - As-Welded	0.89	0.02	0.01	0.06	0.22

<sup>(1)</sup>Typical all weld metal. <sup>(2)</sup>Measured with 0.2% offset. <sup>(3)</sup>See test results disclaimer. <sup>(4)</sup>AWS Requirement for ER309Si is 0.12% max carbon. <sup>(5)</sup>Included in 0.50% max. for other elements not specified.

## TYPICAL OPERATING PROCEDURES

Diameter, Polarity Shielding Gas	CTWD <sup>(6)</sup> mm (in)	Wire Feed Speed m/min (in/min)	Voltage (Volts)	Approx. Current (Amps)	Deposition Rate kg/hr (lb/hr)
<i>Short Circuit Transfer</i>					
<b>0.035 in (0.9 mm), DC+</b> 90% He / 7.5% Ar / 2.5% CO <sub>2</sub>	13 (1/2)	3.0 (120)	20-21	60	0.9 (2.0)
	13 (1/2)	4.6 (180)	21-23	90	1.4 (3.0)
	13 (1/2)	5.8 (230)	22-24	105	1.8 (3.9)
	13 (1/2)	7.6 (300)	23-25	130	2.3 (5.0)
	13 (1/2)	8.9 (350)	24-26	145	2.7 (5.9)
	13 (1/2)	10.2 (400)	25-27	155	3.1 (6.7)
<b>0.045 in (1.1 mm), DC+</b> 90% He / 7.5% Ar / 2.5% CO <sub>2</sub>	13 (1/2)	2.5 (100)	20-21	80	1.1 (2.8)
	13 (1/2)	3.2 (125)	21-22	110	1.5 (3.5)
	13 (1/2)	3.8 (150)	21-23	130	1.7 (4.2)
	13 (1/2)	4.4 (175)	22-24	145	2.0 (4.8)
	13 (1/2)	5.6 (220)	23-25	170	2.6 (6.1)
	13 (1/2)	6.4 (250)	24-26	180	2.9 (6.9)
13 (1/2)	7.0 (275)	25-27	190	3.2 (7.6)	
<i>Axial Spray Transfer</i>					
<b>0.035 in (0.9 mm), DC+</b> 98% Ar / 2% O <sub>2</sub>	13 (1/2)	10.2 (400)	23-24	190	3.1 (6.7)
	13 (1/2)	10.8 (425)	24-25	200	3.3 (7.1)
	13 (1/2)	11.4 (450)	24-25	210	3.5 (7.5)
	13 (1/2)	12.1 (475)	25-26	220	3.7 (8.0)
<b>0.045 in (1.1 mm), DC+</b> 98% Ar / 2% O <sub>2</sub>	13 (1/2)	6.1 (240)	22-24	195	2.8 (6.6)
	13 (1/2)	6.6 (260)	23-25	215	3.0 (7.2)
	13 (1/2)	7.6 (300)	24-26	245	3.5 (8.3)
	13 (1/2)	8.3 (325)	25-27	250	3.8 (9.0)
	13 (1/2)	9.1 (360)	25-27	275	4.2 (10.0)

<sup>(1)</sup>Typical all weld metal. <sup>(2)</sup>Measured with 0.2% offset. <sup>(3)</sup>See test results disclaimer. <sup>(4)</sup>AWS Requirement for ER309Si is 0.12% max carbon. <sup>(5)</sup>Included in 0.50% max. for other elements not specified.

<sup>(6)</sup>To estimate ESO, subtract 1/8 in (3.2 mm) from CTWD.

## IMPORTANT: SPECIAL VENTILATION AND/OR EXHAUST REQUIRED

Fumes from the normal use of some welding products can contain significant quantities of components - such as chromium and manganese - which can lower the 5.0 mg/m<sup>3</sup> maximum exposure guideline for general welding fume.

BEFORE USE, READ AND UNDERSTAND THE SAFETY DATA SHEET (SDS) FOR THIS PRODUCT AND SPECIFIC INFORMATION PRINTED ON THE PRODUCT CONTAINER.



# LINCOLN® RED MAX® 316LSi

Stainless ▪ AWS ER316Si, ER316LSi

## KEY FEATURES

- Engineered surface treatment for weldability control in semiautomatic applications
- High silicon level for increased puddle fluidity and toe wetting
- Q2 Lot® - Certificate showing actual wire composition and calculated ferrite number (FN) available online
- Molybdenum grade for increased corrosion resistance

## WELDING POSITIONS

All

## SHIELDING GAS

Short Circuiting Transfer:

90% He/ 7.5% Ar/ 2.5% CO<sub>2</sub>

Axial Spray Transfer:

98% Argon/ Balance O<sub>2</sub> or CO<sub>2</sub>

## CONFORMANCES

**AWS A5:** ER316LSi, ER316Si

**ABS:** ER316LSi, ER316Si

**ABS:** SS316LSi, SS316Si

## TYPICAL APPLICATIONS

- Semiautomatic welding
- Molybdenum bearing austenitic stainless steels
- 316 and 316L stainless steel

## DIAMETERS / PACKAGING

Diameter in (mm)	33 lb (15 kg) Steel Spool	500 lb (227 kg) Accu-Trak® Drum	500 lb (227 kg) Accu-Pak® Box
0.035 (0.9)	ED036766	ED036974	ED036930
0.045 (1.1)	ED036767	ED036975	ED036931
1/16 (1.6)	ED036768	ED036976	ED036932

## MECHANICAL PROPERTIES<sup>(1)</sup> – As Required per AWS A5.9

	Yield Strength <sup>(2)</sup> MPa (ksi)	Tensile Strength MPa (ksi)	Elongation %	Ferrite Number
<b>Requirements</b> - AWS ER316Si, ER316LSi	Not Specified			
<b>Typical Results<sup>(3)</sup></b> - As-Welded	405 (59)	560 (81)	40	7

## WIRE COMPOSITION<sup>(1)</sup> – As Required per AWS A5.9

	%C <sup>(4)</sup>	%Cr	%Ni	%Mo	%Mn
<b>Requirements</b> - AWS ER316Si, ER316LSi	0.03 max	18.0-20.0	11.0-14.0	2.0-3.0	1.0-2.5
<b>Typical Results<sup>(3)</sup></b>	0.02	18.9	13.7	2.3	2.0
	%Si	%P	%S	%N <sup>(5)</sup>	%Cu
<b>Requirements</b> - AWS ER316Si, ER316LSi	0.65-1.00	0.03 max	0.03 max	Not Specified	0.75 max
<b>Typical Results<sup>(3)</sup></b>	0.89	0.02	0.01	0.06	0.22

<sup>(1)</sup>Typical all weld metal. <sup>(2)</sup>Measured with 0.2% offset. <sup>(3)</sup>See test results disclaimer. <sup>(4)</sup>AWS Requirement for ER316Si is 0.08% max carbon. <sup>(5)</sup>Included in 0.50% max. for other elements not specified.

## TYPICAL OPERATING PROCEDURES

Diameter, Polarity Shielding Gas	CTWD <sup>(6)</sup> mm (in)	Wire Feed Speed m/min (in/min)	Voltage (Volts)	Approx. Current (Amps)	Deposition Rate kg/hr (lb/hr)
<i>Short Circuit Transfer</i>					
<b>0.035 in (0.9 mm), DC+</b> 90% He / 7.5% Ar / 2.5% CO <sub>2</sub>	13 (1/2)	3.0 (120)	20-21	60	0.9 (2.0)
	13 (1/2)	4.6 (180)	21-23	90	1.4 (3.0)
	13 (1/2)	5.8 (230)	22-24	105	1.8 (3.9)
	13 (1/2)	7.6 (300)	23-25	130	2.3 (5.0)
	13 (1/2)	8.9 (350)	24-26	145	2.7 (5.9)
	13 (1/2)	10.2 (400)	25-27	155	3.1 (6.7)
<b>0.045 in (1.1 mm), DC+</b> 90% He / 7.5% Ar / 2.5% CO <sub>2</sub>	13 (1/2)	2.5 (100)	20-21	80	1.1 (2.8)
	13 (1/2)	3.2 (125)	21-22	110	1.5 (3.5)
	13 (1/2)	3.8 (150)	21-23	130	1.7 (4.2)
	13 (1/2)	4.4 (175)	22-24	145	2.0 (4.8)
	13 (1/2)	5.6 (220)	23-25	170	2.6 (6.1)
	13 (1/2)	6.4 (250)	24-26	180	2.9 (6.9)
13 (1/2)	7.0 (275)	25-27	190	3.2 (7.6)	
<i>Axial Spray Transfer</i>					
<b>0.035 in (0.9 mm), DC+</b> 98% Ar / 2% O <sub>2</sub>	13 (1/2)	10.2 (400)	23-24	190	3.1 (6.7)
	13 (1/2)	10.8 (425)	24-25	200	3.3 (7.1)
	13 (1/2)	11.4 (450)	24-25	210	3.5 (7.5)
	13 (1/2)	12.1 (475)	25-26	220	3.7 (8.0)
<b>0.045 in (1.1 mm), DC+</b> 98% Ar / 2% O <sub>2</sub>	13 (1/2)	6.1 (240)	22-24	195	2.8 (6.6)
	13 (1/2)	6.6 (260)	23-25	215	3.0 (7.2)
	13 (1/2)	7.6 (300)	24-26	245	3.5 (8.3)
	13 (1/2)	8.3 (325)	25-27	250	3.8 (9.0)
	13 (1/2)	9.1 (360)	25-27	275	4.2 (10.0)

<sup>(1)</sup>Typical all weld metal. <sup>(2)</sup>Measured with 0.2% offset. <sup>(3)</sup>See test results disclaimer. <sup>(4)</sup>AWS Requirement for ER316Si is 0.08% max carbon. <sup>(5)</sup>Included in 0.50% max. for other elements not specified. <sup>(6)</sup>To estimate ESO, subtract 1/8 in (3.2 mm) from CTWD.

## IMPORTANT: SPECIAL VENTILATION AND/OR EXHAUST REQUIRED

Fumes from the normal use of some welding products can contain significant quantities of components - such as chromium and manganese - which can lower the 5.0 mg/m<sup>3</sup> maximum exposure guideline for general welding fume.

BEFORE USE, READ AND UNDERSTAND THE SAFETY DATA SHEET (SDS) FOR THIS PRODUCT AND SPECIFIC INFORMATION PRINTED ON THE PRODUCT CONTAINER.

# LINCOLN® RED MAX® 307\_MOD

Stainless ▪ Similar to AWS ER307

## KEY FEATURES

- Austenitic stainless steel
- 7% Manganese (Mn) increases resistance to hot cracking between dissimilar steels
- Q2 Lot® - Certificates showing actual wire composition and calculated ferrite number (FN) available online

## WELDING POSITIONS

All

## CONFORMANCES

ISO 14343-A: G 188 Mn  
\*Similar to ER307

## TYPICAL APPLICATIONS

- Automotive exhaust systems
- Armor Plate (military)
- Designed for joining dissimilar stainless steels
- Work hardening manganese steel

## SHIELDING GAS

Short Circuiting Transfer  
90% He / 7.5% Argon / 2.5% CO<sub>2</sub>  
Axial Spray Transfer  
98% Argon / Balance O<sub>2</sub> or CO<sub>2</sub>

## DIAMETERS / PACKAGING

Diameter in (mm)	33 lb (15 kg) Steel Spool	500 lb (227 kg) Accu-Trak® Drum	500 lb (227 kg) Accu-Pak® Box
0.035 (0.9)	ED036933	ED036936	ED036937
0.045 (1.1)	ED036934	ED036938	ED036939
1/16 (1.6)	ED036935	ED036940	ED036941

## MECHANICAL PROPERTIES<sup>(1)</sup>

	Yield Strength <sup>(2)</sup> MPa (ksi)	Tensile Strength MPa (ksi)	Elongation %
Typical Results <sup>(3)</sup> - As-Welded	627 (91)	434 (63)	38

## WIRE COMPOSITION<sup>(1)</sup>

	%C	%Mn	%Si	%Cr	%Ni	%S	%P
Typical Results <sup>(2)</sup>	0.08	7.1	0.80	18.8	8.6	0.009	0.023

<sup>(1)</sup>Typical wire composition. <sup>(2)</sup>See test results disclaimer

## TYPICAL OPERATING PROCEDURES

Diameter, Polarity Shielding Gas	CTWD <sup>(6)</sup> mm (in)	Wire Feed Speed m/min (in/min)	Voltage (Volts)	Approx. Current (Amps)	Deposition Rate kg/hr (lb/hr)
<i>Short Circuit Transfer</i>					
<b>0.035 in (0.9 mm), DC+</b> 90% He / 7.5% Ar / 2.5% CO <sub>2</sub>	13 (1/2)	3.0 (120)	20-21	60	0.9 (2.0)
	13 (1/2)	4.6 (180)	21-23	90	1.4 (3.0)
	13 (1/2)	5.8 (230)	22-24	105	1.8 (3.9)
	13 (1/2)	7.6 (300)	23-25	130	2.3 (5.0)
	13 (1/2)	8.9 (350)	24-26	145	2.7 (5.9)
	13 (1/2)	10.2 (400)	25-27	155	3.1 (6.7)
<b>0.045 in (1.1 mm), DC+</b> 90% He / 7.5% Ar / 2.5% CO <sub>2</sub>	13 (1/2)	2.5 (100)	20-21	80	1.1 (2.8)
	13 (1/2)	3.2 (125)	21-22	110	1.5 (3.5)
	13 (1/2)	3.8 (150)	21-23	130	1.7 (4.2)
	13 (1/2)	4.4 (175)	22-24	145	2.0 (4.8)
	13 (1/2)	5.6 (220)	23-25	170	2.6 (6.1)
	13 (1/2)	6.4 (250)	24-26	180	2.9 (6.9)
13 (1/2)	7.0 (275)	25-27	190	3.2 (7.6)	
<i>Axial Spray Transfer</i>					
<b>0.035 in (0.9 mm), DC+</b> 98% Ar / 2% O <sub>2</sub>	13 (1/2)	10.2 (400)	23-24	190	3.1 (6.7)
	13 (1/2)	10.8 (425)	24-25	200	3.3 (7.1)
	13 (1/2)	11.4 (450)	24-25	210	3.5 (7.5)
	13 (1/2)	12.1 (475)	25-26	220	3.7 (8.0)
<b>0.045 in (1.1 mm), DC+</b> 98% Ar / 2% O <sub>2</sub>	13 (1/2)	6.1 (240)	22-24	195	2.8 (6.6)
	13 (1/2)	6.6 (260)	23-25	215	3.0 (7.2)
	13 (1/2)	7.6 (300)	24-26	245	3.5 (8.3)
	13 (1/2)	8.3 (325)	25-27	250	3.8 (9.0)
	13 (1/2)	9.1 (360)	25-27	275	4.2 (10.0)

<sup>(1)</sup>Typical all weld metal. <sup>(2)</sup>Measured with 0.2% offset. <sup>(3)</sup>See test results disclaimer. <sup>(4)</sup>AWS Requirement for ER308Si is 0.08% max carbon. <sup>(5)</sup>Included in 0.50% max. for other elements not specified. <sup>(6)</sup>To estimate ESO, subtract 1/8 in (3.2 mm) from CTWD.

## IMPORTANT: SPECIAL VENTILATION AND/OR EXHAUST REQUIRED

Fumes from the normal use of some welding products can contain significant quantities of components - such as chromium and manganese - which can lower the 5.0 mg/m<sup>3</sup> maximum exposure guideline for general welding fume.

BEFORE USE, READ AND UNDERSTAND THE SAFETY DATA SHEET (SDS) FOR THIS PRODUCT AND SPECIFIC INFORMATION PRINTED ON THE PRODUCT CONTAINER.

# MUREX® 308LSI

Stainless ▪ AWS ER308Si, ER308LSi

## KEY FEATURES

- Similar in composition to 308L with higher silicon content to increase puddle fluidity and improve the bead appearance
- Q2 Lot® - Certificate showing actual wire composition and calculated ferrite number (FN) available online
- Used to primarily weld equipment made with 304 type stainless steel

## WELDING POSITIONS

All

## CONFORMANCES

- |                        |                   |
|------------------------|-------------------|
| <b>AWS A5.9:</b>       | ER308Si, ER308LSi |
| <b>ASME SFA-5.9:</b>   | ER308Si, ER308LSi |
| <b>ABS:</b>            | ER308Si, ER308LSi |
| <b>CWB/CSA W48-06:</b> | ER308LSi          |

## TYPICAL APPLICATIONS

- 304 and 304L stainless steels
- Common austenitic stainless steels referred to as "18-8" steels
- ASTM A743 or A744 Types CF-8 and CF-3

## SHIELDING GAS

Short Circuiting Transfer:  
90% He / 7.5% Ar / 2.5% CO<sub>2</sub>  
Axial Spray Transfer:  
98% Argon / 2% Oxygen

## DIAMETERS / PACKAGING

Diameter in (mm)	33 lb (14.9 kg) Steel Spool	500 lb (227 kg) Accu-Trak® Drum
0.030 (0.8)	ED036497	
0.035 (0.9)	ED035601	ED035604
0.045 (1.1)	ED035603	ED035605
1/16 (1.6)	ED035602	

## WIRE COMPOSITION<sup>(1)</sup> – As Required per AWS A5.9

	%C <sup>(4)</sup>	%Cr	%Ni	%Mo	%Mn
<b>Requirements - AWS ER308LSi</b>	0.03 max	19.5-22.0	9.0-11.0	0.75 max	1.0-2.5
<b>Typical Results<sup>(3)</sup></b>	0.02	19.9	9.6	0.08	2.0
	%Si	%P	%S	%N <sup>(5)</sup>	%Cu
<b>Requirements - AWS ER308LSi</b>	0.65-1.00	0.03 max	0.03 max	Not Specified	0.75 max
<b>Typical Results<sup>(3)</sup></b>	0.81	0.02	0.02	0.05	0.06

<sup>(1)</sup>Typical all weld metal. <sup>(2)</sup>Measured with 0.2% offset. <sup>(3)</sup>See test results disclaimer <sup>(4)</sup>AWS Requirements for ER308Si is 0.08% max carbon. <sup>(5)</sup>Included in 0.50% max. for other elements not specified.

IMPORTANT: SPECIAL VENTILATION AND/OR EXHAUST REQUIRED

Fumes from the normal use of some welding products can contain significant quantities of components - such as chromium and manganese - which can lower the 5.0 mg/m<sup>3</sup> maximum exposure guideline for general welding fume.

BEFORE USE, READ AND UNDERSTAND THE SAFETY DATA SHEET (SDS) FOR THIS PRODUCT AND SPECIFIC INFORMATION PRINTED ON THE PRODUCT CONTAINER.

# MUREX® 309LSi

Stainless ▪ AWS ER309Si, ER309LSi

## KEY FEATURES

- Similar in composition to 309L with higher silicon content to increase puddle fluidity and improve the bead appearance
- Q2 Lot® - Certificate showing actual wire composition and calculated ferrite number (FN) available online
- Excellent contour of the weld minimizes the need for grinding

## WELDING POSITIONS

All

## CONFORMANCES

<b>AWS A5.9:</b>	ER309Si, ER309LSi
<b>ASME SFA-5.9:</b>	ER309Si, ER309LSi
<b>ABS:</b>	ER309Si, ER309LSi
<b>CWB/CSA W48-06:</b>	ER309LSi

## TYPICAL APPLICATIONS

- Designed for joining stainless steel to mild or low alloy steel

## SHIELDING GAS

Short Circuiting Transfer:  
90% He/ 7.5% Ar/ 2.5% CO<sub>2</sub>

Axial Spray Transfer:  
98% Argon/ 2% Oxygen

## DIAMETERS / PACKAGING

Diameter in (mm)	33 lb (14.9 kg) Steel Spool	500 lb (227 kg) Accu-Trak® Drum
0.035 (0.9)	ED035606	ED035609
0.045 (1.1)	ED035608	ED035610

## WIRE COMPOSITION<sup>(1)</sup> – As Required per AWS A5.9

	%C <sup>(4)</sup>	%Cr	%Ni	%Mo	%Mn
<b>Requirements</b> - AWS ER309LSi	0.03 max	23.0-25.0	12.0- 14.0	0.75 max	1.0-2.5
<b>Typical Results</b> <sup>(3)</sup>	0.02	23.4	13.7	0.30	2.1
	%Si	%P	%S	%N <sup>(5)</sup>	%Cu
<b>Requirements</b> - AWS ER309LSi	0.65-1.00	0.03 max	0.03 max	Not Specified	0.75 max
<b>Typical Results</b> <sup>(3)</sup>	0.77	0.02	<0.01	0.09	0.09

<sup>(1)</sup>Typical wire composition. <sup>(2)</sup>Measured with 0.2% offset <sup>(3)</sup>See test results disclaimer <sup>(4)</sup>AWS Requirement for ER309Si is 0.12% max. carbon. <sup>(5)</sup>Included in 0.50% max. for other elements not specified.

IMPORTANT: SPECIAL VENTILATION AND/OR EXHAUST REQUIRED

Fumes from the normal use of some welding products can contain significant quantities of components - such as chromium and manganese - which can lower the 5.0 mg/m<sup>3</sup> maximum exposure guideline for general welding fume.

BEFORE USE, READ AND UNDERSTAND THE SAFETY DATA SHEET (SDS) FOR THIS PRODUCT AND SPECIFIC INFORMATION PRINTED ON THE PRODUCT CONTAINER.

# MUREX® 316LSI

Stainless ▪ AWS ER316Si, ER316LSi

## KEY FEATURES

- Similar in composition to 316L with higher silicon content to increase puddle fluidity and improve the bead appearance
- Molybdenum grade for increased corrosion resistance
- Q2 Lot® - Certificate showing actual wire composition and calculated ferrite number (FN) available online

## WELDING POSITIONS

All

## CONFORMANCES

<b>AWS A5.9:</b>	ER316Si, ER316LSi
<b>ASME SFA-5.9:</b>	ER316Si, ER316LSi
<b>ABS:</b>	ER316Si, ER316LSi
<b>CWB/CSA W48-06:</b>	ER316LSi

## TYPICAL APPLICATIONS

- Molybdenum bearing austenitic stainless steels
- Type 316 and 316L

## SHIELDING GAS

Short Circuiting Transfer:

90% He / 7.5% Argon / 2.5% CO<sub>2</sub>

Axial Spray Transfer:

98% Argon / 2% Oxygen

## DIAMETERS / PACKAGING

Diameter in (mm)	33 lb (14.9 kg) Steel Spool	500 lb (227 kg) Accu-Trak® Drum
0.030 (0.8)	ED036499	
0.035 (0.9)	ED035611	ED035614
0.045 (1.1)	ED035613	ED035615

**WIRE COMPOSITION<sup>(1)</sup> – As Required per AWS A5.9**

	<b>%C<sup>(4)</sup></b>	<b>%Cr</b>	<b>%Ni</b>	<b>%Mo</b>	<b>%Mn</b>
<b>Requirements - AWS ER316LSi</b>	0.03 max	18.0-20.0	11.0-14.0	2.0-3.0	1.0-2.5
<b>Typical Results<sup>(3)</sup></b>	0.02	18.3	11.3	2.2	1.6
	<b>%Si</b>	<b>%P</b>	<b>%S</b>	<b>%N<sup>(5)</sup></b>	<b>%Cu</b>
<b>Requirements - AWS ER316LSi</b>	0.65-1.00	0.03 max	0.03 max	Not Specified	0.75 max
<b>Typical Results<sup>(3)</sup></b>	0.82	0.02	0.02	0.07	0.10

<sup>(1)</sup>Typical wire composition. <sup>(2)</sup>Measured with 0.2% offset. <sup>(3)</sup>See test results disclaimer. <sup>(4)</sup>AWS Requirement for ER316Si is 0.08% max. carbon. <sup>(5)</sup>Included in 0.50% max. for other elements not specified.

**IMPORTANT: SPECIAL VENTILATION AND/OR EXHAUST REQUIRED**

Fumes from the normal use of some welding products can contain significant quantities of components - such as chromium and manganese - which can lower the 5.0 mg/m<sup>3</sup> maximum exposure guideline for general welding fume.

BEFORE USE, READ AND UNDERSTAND THE SAFETY DATA SHEET (SDS) FOR THIS PRODUCT AND SPECIFIC INFORMATION PRINTED ON THE PRODUCT CONTAINER.



# ULTRACORE® 308L

Stainless | AWS E308T0-1, E308T0-4, E308LT0-1, E308LT0-4

## KEY FEATURES

- Precision layer wound winding delivers steady spool payoff and more consistent feeding
- Smooth arc action with minimal spatter reduces post-weld cleaning
- Polished weld bead appearance reduces post-weld brushing

## WELDING POSITIONS

Flat & Horizontal

## RECOMMENDED FLUX

N/A

## CONFORMANCES

- AWS A5:** E308LT0-1, E308LT0-4  
**ABS:** E308LT0-1, E308LT0-4  
**CWB/CSA:** E308LT0-1, E308LT0-4

## TYPICAL APPLICATIONS

- 304L and other common 18/8 stainless steels
- Nitrogen bearing 304LN and titanium stabilized 321
- General fabrication including piping, tanks, and pressure vessels

## SHIELDING GAS

- FCAW-G:** 75% Ar/25% CO<sub>2</sub>  
 100% CO<sub>2</sub>

## DIAMETERS / PACKAGING

Diameter mm (in)	33 lb (15 kg) Plastic Spool (Vacuum Sealed Foil Bag)
1.1 (0.045)	ED037118
1.6 1/16	ED037119

## MECHANICAL PROPERTIES<sup>(1)</sup>

	Yield Strength <sup>(2)</sup> MPa (ksi)	Tensile Strength MPa (ksi)	Elongation %	Ferrite Number
<b>Requirements</b>				
AWS E308LT0-1, E308LT0-4	Not Specified	520 (75) min	35 min	Not Specified
AWS E308T0-1, E308T0-4	Not Specified	550 (80) min		Not Specified
<b>Typical Results<sup>(3)</sup></b>				
As-Welded with 100% CO <sub>2</sub>	386 (56)	566 (82)	40	7-11
As-Welded with 75% Ar/25% CO <sub>2</sub>	393 (57)	572 (83)	39	8-12

<sup>(1)</sup>Typical all weld metal, DC+ <sup>(2)</sup>Measured with 0.2% offset <sup>(3)</sup>See test results disclaimer

**DEPOSIT COMPOSITION<sup>(1)</sup>**

	%C <sup>(4)</sup>	%Mn	%Si	%S	%P
<b>Requirements</b> AWS E308LTO-1 & E308LTO-4	0.04 max	0.5-2.5	1.0 max	0.03 max	0.04 max
<b>Typical Results<sup>(3)</sup></b> As-Welded with 100% CO <sub>2</sub>	≤0.03	1.2-1.3	0.6-0.7	≤ 0.01	≤ 0.02
As-Welded with 75% Ar/25% CO <sub>2</sub>	≤0.03	1.4-1.5	0.7-0.8	≤ 0.01	≤ 0.02
	%Ni	%Cr	%Mo	%Cu	%Bi
<b>Requirements</b> AWS E308LTO-1 & E308LTO-4	9.0-11.0	18.0-21.0	0.75 max	0.75 max	—
<b>Typical Results<sup>(3)</sup></b> As-Welded with 100% CO <sub>2</sub>	9.5-9.9	18.0-18.6	≤ 0.20	≤ 0.25	0.02
As-Welded with 75% Ar/25% CO <sub>2</sub>	9.7-9.9	18.5-19.0	≤ 0.20	≤ 0.25	0.02

<sup>(1)</sup>Typical all weld metal, DC+ <sup>(3)</sup>See test results disclaimer <sup>(4)</sup>Requirement for E316T1-1 and E316T1-4 is 0.08% max. carbon

**TYPICAL OPERATING PROCEDURES**

Diameter, Polarity, Shielding Gas in (mm)	CTWD <sup>(5)</sup> mm (in)	Wire Feed Speed/Voltage m/min (in/min)	Voltage (Volts)	Approx. Current (Amps)	Melt-Off Rate kg/hr (lb/hr)	Deposition Rate kg/hr (lb/hr)	Efficiency (%)
0.045 in (1.1 mm), DC+ 75% Ar/25% CO <sub>2</sub>	19 (3/4)	5.3 (210)	22-24	140	2.1 (4.6)	1.8 (4.0)	86
	19 (3/4)	8.9 (350)	24-26	185	3.6 (8.0)	3.1 (6.9)	86
	19 (3/4)	11.4 (450)	26-28	225	4.7 (10.4)	4.0 (8.8)	84
1/16 in (1.6 mm), DC+ 75% Ar/25% CO <sub>2</sub>	25 (1)	3.6 (140)	25-29	155	2.8 (6.2)	2.6 (5.2)	89.6
	25 (1)	6.4 (250)	27-31	250	5.0 (11.0)	4.2 (9.2)	89.3
	25 (1)	8.1 (320)	28-32	285	6.0 (13.2)	5.3 (11.7)	88.6

<sup>(5)</sup>To estimate ESO, subtract 1/4 in (6.0 mm) from CTWD. NOTE: Increase Voltage by 2V when using 100% CO<sub>2</sub>

IMPORTANT: SPECIAL VENTILATION AND/OR EXHAUST REQUIRED

Fumes from the normal use of some welding products can contain significant quantities of components - such as chromium and manganese - which can lower the 5.0 mg/m<sup>3</sup> maximum exposure guideline for general welding fume.

BEFORE USE, READ AND UNDERSTAND THE SAFETY DATA SHEET (SDS) FOR THIS PRODUCT AND SPECIFIC INFORMATION PRINTED ON THE PRODUCT CONTAINER.

# ULTRACORE® 308L P

Stainless | AWS E308T1-1, E308T1-4, E308LT1-1, E308LT1-4

## KEY FEATURES

- Precision layer wound winding delivers steady spool payoff and more consistent feeding
- Smooth arc action with minimal spatter reduces post-weld cleaning
- Polished weld bead appearance reduces post-weld brushing

## WELDING POSITIONS

All Positions

## RECOMMENDED FLUX

N/A

## CONFORMANCES

- AWS A5:** E308LT1-1, E308LT1-4  
**ABS:** E308LT1-1, E308LT1-4  
**CWB/CSA:** E308LT1-1, E308LT1-4

## TYPICAL APPLICATIONS

- 304L and other common 18/8 stainless steels
- Nitrogen bearing 304LN and titanium stabilized 321
- General fabrication including piping, tanks and pressure vessels

## SHIELDING GAS

- FCAW-G:** 75% Ar/25% CO<sub>2</sub>  
 100% CO<sub>2</sub>

## DIAMETERS / PACKAGING

Diameter in (mm)	33 lb (15 kg) Plastic Spool (Vacuum Sealed Foil Bag)
0.045 (1.1)	ED037125
1/16 (1.6)	ED037126

## MECHANICAL PROPERTIES<sup>(1)</sup>

	Yield Strength <sup>(2)</sup> MPa (ksi)	Tensile Strength MPa (ksi)	Elongation %	Ferrite Number
<b>Requirements</b>				
AWS E308LT1-1, E308LT1-4	Not Specified	520 (75) min	35 min	Not Specified
AWS E308T1-1, E308T1-4	Not Specified	550 (80) min	35 min	Not Specified
<b>Typical Results<sup>(3)</sup></b>				
As-Welded with 100% CO <sub>2</sub>	386 (56)	566 (82)	40	7-11
As-Welded with 75% Ar/25% CO <sub>2</sub>	393 (57)	572 (83)	39	8-12

<sup>(1)</sup>Typical all weld metal, DC+ <sup>(2)</sup> Measured with 0.2% offset <sup>(3)</sup> See test results disclaimer

**DEPOSIT COMPOSITION<sup>(1)</sup>**

	%C <sup>(4)</sup>	%Mn	%Si	%S	%P
<b>Requirements</b> AWS E308LT1-1 & E308LT1-4	0.04 max	0.5-2.5	1.0 max	0.03 max	0.04 max
<b>Typical Results<sup>(3)</sup></b> As-Welded with 100% CO <sub>2</sub>	≤0.03	1.2-1.3	0.6-0.7	≤ 0.01	≤ 0.02
As-Welded with 75% Ar/25% CO <sub>2</sub>	≤0.03	1.4-1.5	0.7-0.8	≤ 0.01	≤ 0.02
	%Ni	%Cr	%Mo	%Cu	%Bi
<b>Requirements</b> AWS E308LT1-1 & E308LT1-4	9.0-11.0	18.0-21.0	0.75 max	0.75 max	—
<b>Typical Results<sup>(3)</sup></b> As-Welded with 100% CO <sub>2</sub>	9.5-9.9	18.0-18.6	≤ 0.20	≤ 0.25	0.01
As-Welded with 75% Ar/25% CO <sub>2</sub>	9.7-9.9	18.5-19.0	≤ 0.20	≤ 0.25	0.01

**TYPICAL OPERATING PROCEDURES**

Diameter, Polarity, Shielding Gas in (mm)	CTWD <sup>(5)</sup> mm (in)	Wire Feed Speed/Voltage m/min (in/min)	Voltage (Volts)	Approx. Current (Amps)	Melt-Off Rate kg/hr (lb/hr)	Deposition Rate kg/hr (lb/hr)	Efficiency (%)
0.045 in (1.1 mm), DC+ 75% Ar/25% CO <sub>2</sub>	19 (3/4)	5.1 (200)	22-24	130	2.0 (4.3)	1.5 (3.3)	76.7
	19 (3/4)	8.4 (330)	24-26	180	3.3 (7.2)	2.6 (5.7)	79.1
	19 (3/4)	11.2 (440)	26-28	220	4.3 (9.5)	3.5 (7.8)	82.1
1/16 in (1.6 mm), DC+ 75% Ar/25% CO <sub>2</sub>	25 (1)	3.6 (140)	24-26	160	2.5 (5.6)	2.2 (4.8)	85.7
	25 (1)	5.0 (195)	24-26	200	3.5 (7.8)	3.0 (6.7)	85.8
	25 (1)	6.4 (250)	25-27	220	4.6 (10.1)	3.9 (8.6)	85.6

<sup>(5)</sup>To estimate ESO, subtract 1/4 in (6.0 mm) from CTWD. NOTE: Increase Voltage by 2V when using 100% CO<sub>2</sub>

IMPORTANT: SPECIAL VENTILATION AND/OR EXHAUST REQUIRED

Fumes from the normal use of some welding products can contain significant quantities of components - such as chromium and manganese - which can lower the 5.0 mg/m<sup>3</sup> maximum exposure guideline for general welding fume.

BEFORE USE, READ AND UNDERSTAND THE SAFETY DATA SHEET (SDS) FOR THIS PRODUCT AND SPECIFIC INFORMATION PRINTED ON THE PRODUCT CONTAINER.

# ULTRACORE® 309L

Stainless ▪ AWS E309T0-1, E309T0-4, E309LT0-1, E309LT0-4

## KEY FEATURES

- Precision layer wound winding delivers steady spool payoff and more consistent feeding
- Smooth arc action with minimal spatter reduces post-weld cleaning
- Polished weld bead appearance reduces post-weld brushing

## WELDING POSITIONS

Flat & Horizontal

## RECOMMENDED FLUX

N/A

## CONFORMANCES

- AWS A5:** E309LT0-1, E309LT0-4  
**ABS:** E309LT0-1, E309LT0-4  
**CWB/CSA:** E309LT0-1, E309LT0-4

## TYPICAL APPLICATIONS

- Buffer layers and clad steels – overlays on CMn, mild steel or low alloy steels
- Dissimilar joints – stainless types 410, 304L, 321, and 316L to mild and low alloy steels

## SHIELDING GAS

- FCAW-G:** 75% Ar/25% CO<sub>2</sub>  
 100% CO<sub>2</sub>

## DIAMETERS / PACKAGING

Diameter in (mm)	33 lb (15 kg) Plastic Spool (Vacuum Sealed Foil Bag)
0.045 (1.1)	ED037120
1/16 (1.6)	ED037121

## MECHANICAL PROPERTIES<sup>(1)</sup>

	Yield Strength <sup>(2)</sup> MPa (ksi)	Tensile Strength MPa (ksi)	Elongation %	Ferrite Number
<b>Requirements</b>				
AWS E309LT0-1, E309LT0-4	Not Specified	520 (75) min	35 min	Not Specified
AWS E309T0-1, E309T0-4	Not Specified	550 (80) min	35 min	Not Specified
<b>Typical Results<sup>(3)</sup></b>				
As-Welded with 100% CO <sub>2</sub>	434 (63)	565 (82)	33	—
As-Welded with 75% Ar/25% CO <sub>2</sub>	450 (65)	593 (86)	33	—

<sup>(1)</sup>Typical all weld metal, DC+ <sup>(2)</sup> Measured with 0.2% offset <sup>(3)</sup> See test results disclaimer

**DEPOSIT COMPOSITION<sup>(1)</sup>**

	%C <sup>(4)</sup>	%Mn	%Si	%S	%P
<b>Requirements</b> AWS E309LT0-1 & E309LT0-4	0.04 max	0.5-2.5	1.0 max	0.03 max	0.04 max
<b>Typical Results<sup>(3)</sup></b> As-Welded with 100% CO <sub>2</sub>	≤0.03	1.0	0.8	≤ 0.01	≤ 0.02
As-Welded with 75% Ar/25% CO <sub>2</sub>	≤0.03	1.0	0.9	≤ 0.01	≤ 0.02
	%Ni	%Cr	%Mo	%Cu	%Bi
<b>Requirements</b> AWS E309LT0-1 & E309LT0-4	12.0-14.0	22.0-25.0	0.75 max	0.75 max	—
<b>Typical Results<sup>(3)</sup></b> As-Welded with 100% CO <sub>2</sub>	12.8-13.2	23.6-23.9	≤ 0.20	≤ 0.25	0.02
As-Welded with 75% Ar/25% CO <sub>2</sub>	12.9-13.3	23.9-24.1	≤ 0.20	≤ 0.25	0.02

<sup>(1)</sup>Typical all weld metal, DC+ <sup>(2)</sup>See test results disclaimer <sup>(3)</sup>Requirement for E316T1-1 and E316T1-4 is 0.08% max. carbon

**TYPICAL OPERATING PROCEDURES**

Diameter, Polarity, Shielding Gas in (mm)	CTWD <sup>(5)</sup> mm (in)	Wire Feed Speed/Voltage m/min (in/min)	Voltage (Volts)	Approx. Current (Amps)	Melt-Off Rate kg/hr (lb/hr)	Deposition Rate kg/hr (lb/hr)	Efficiency (%)
0.045 in (1.1 mm), DC+ 75% Ar/25% CO <sub>2</sub>	19 (3/4)	5.3 (210)	22-24	140	2.1 (4.6)	1.9 (4.2)	91.3
	19 (3/4)	8.9 (350)	24-26	185	3.9 (8.7)	3.4 (7.5)	86.2
	19 (3/4)	11.4 (450)	26-28	225	4.7 (10.3)	4.4 (9.6)	93.2
1/16 in (1.6 mm), DC+ 75% Ar/25% CO <sub>2</sub>	25 (1)	3.6 (140)	23-25	165	2.7 (5.9)	2.3 (5.0)	84.7
	25 (1)	6.4 (250)	25-27	235	4.8 (10.6)	4.2 (9.3)	87.7
	25 (1)	8.1 (320)	26-28	290	6.1 (13.5)	5.4 (12)	88.8

<sup>(5)</sup>To estimate ESO, subtract 1/4 in (6.0 mm) from CTWD. NOTE: Increase Voltage by 2V when using 100% CO<sub>2</sub>

IMPORTANT: SPECIAL VENTILATION AND/OR EXHAUST REQUIRED

Fumes from the normal use of some welding products can contain significant quantities of components - such as chromium and manganese - which can lower the 5.0 mg/m<sup>3</sup> maximum exposure guideline for general welding fume.

BEFORE USE, READ AND UNDERSTAND THE SAFETY DATA SHEET (SDS) FOR THIS PRODUCT AND SPECIFIC INFORMATION PRINTED ON THE PRODUCT CONTAINER.

# ULTRACORE® 309L P

Stainless | AWS E309T1-1, E309T1-4, E309LT1-1, E309LT1-4

## KEY FEATURES

- Precision layer wound winding delivers steady spool payoff and more consistent feeding
- Smooth arc action with minimal spatter reduces post-weld cleaning
- Polished weld bead appearance reduces post-weld brushing

## WELDING POSITIONS

All Positions

## RECOMMENDED FLUX

N/A

## CONFORMANCES

- AWS A5:** E309LT1-1, E309LT1-4  
**ABS:** E309LT1-1, E309LT1-4  
**CWB/CSA:** E309LT1-1, E309LT1-4

## TYPICAL APPLICATIONS

- Buffer layers and clad steels – overlays on CMn, mild steel or low alloy steels
- Dissimilar joints – stainless types 410, 304L, 321, and 316L to mild and low alloy steels

## SHIELDING GAS

- FCAW-G:** 75% Ar/25% CO<sub>2</sub>  
 100% CO<sub>2</sub>

## DIAMETERS / PACKAGING

Diameter in (mm)	33 lb (15 kg) Plastic Spool (Vacuum Sealed Foil Bag)
0.045 (1.1)	ED037127
1/16 (1.6)	ED037128

## MECHANICAL PROPERTIES<sup>(1)</sup>

	Yield Strength <sup>(2)</sup> MPa (ksi)	Tensile Strength MPa (ksi)	Elongation %	Ferrite Number
<b>Requirements</b>				
AWS E309LT1-1, E309LT1-4	Not Specified	520 (75) min	30 min	Not Specified
AWS E309T1-1, E309T1-4	Not Specified	550 (80) min	30 min	Not Specified
<b>Typical Results<sup>(3)</sup></b>				
As-Welded with 100% CO <sub>2</sub>	434 (63)	565 (82)	33	—
As-Welded with 75% Ar/25% CO <sub>2</sub>	450 (65)	593 (86)	33	—

<sup>(1)</sup>Typical all weld metal, DC+ <sup>(2)</sup> Measured with 0.2% offset <sup>(3)</sup> See test results disclaimer

**DEPOSIT COMPOSITION<sup>(1)</sup>**

	%C <sup>(4)</sup>	%Mn	%Si	%S	%P
<b>Requirements</b> AWS E309LT1-1 & E309LT1-4	0.04 max	0.5-2.5	1.0 max	0.03 max	0.04 max
<b>Typical Results<sup>(3)</sup></b> As-Welded with 100% CO <sub>2</sub>	≤0.03	1.0	0.8	≤ 0.01	≤ 0.02
As-Welded with 75% Ar/25% CO <sub>2</sub>	≤0.03	1.0	0.9	≤ 0.01	≤ 0.02
	%Ni	%Cr	%Mo	%Cu	%Bi
<b>Requirements</b> AWS E309LT1-1 & E309LT1-4	12.0-14.0	22.0-25.0	0.75 max	0.75 max	—
<b>Typical Results<sup>(3)</sup></b> As-Welded with 100% CO <sub>2</sub>	12.8-13.2	23.6-23.9	≤ 0.20	≤ 0.25	0.01
As-Welded with 75% Ar/25% CO <sub>2</sub>	12.9-13.3	23.9-24.1	≤ 0.20	≤ 0.25	0.01

<sup>(1)</sup>Typical all weld metal, DC+ <sup>(3)</sup>See test results disclaimer <sup>(4)</sup>Requirement for E316T1-1 and E316T1-4 is 0.08% max. carbon

**TYPICAL OPERATING PROCEDURES**

Diameter, Polarity, Shielding Gas in (mm)	CTWD <sup>(5)</sup> mm (in)	Wire Feed Speed/Voltage m/min (in/min)	Voltage (Volts)	Approx. Current (Amps)	Melt-Off Rate kg/hr (lb/hr)	Deposition Rate kg/hr (lb/hr)	Efficiency (%)
0.045 in (1.1 mm), DC+ 75% Ar/25% CO <sub>2</sub>	19 (3/4)	5.1 (200)	22-24	130	2.1 (4.6)	1.7 (3.8)	82.6
	19 (3/4)	8.4 (330)	24-26	180	3.4 (7.4)	2.8 (6.1)	82.4
	19 (3/4)	11.2 (440)	26-28	220	4.5 (10)	3.7 (8.1)	81
1/16 in (1.6 mm), DC+ 75% Ar/25% CO <sub>2</sub>	25 (1)	3.6 (140)	22-24	150	2.5 (5.6)	2.2 (4.8)	85.7
	25 (1)	5.0 (195)	24-26	190	3.6 (7.9)	3.0 (6.7)	84.8
	25 (1)	7.1 (280)	25-27	220	5.2 (11.4)	4.4 (9.6)	84.2

<sup>(5)</sup>To estimate ESO, subtract 1/4 in (6.0 mm) from CTWD. NOTE: Increase Voltage by 2V when using 100% CO<sub>2</sub>

IMPORTANT: SPECIAL VENTILATION AND/OR EXHAUST REQUIRED

Fumes from the normal use of some welding products can contain significant quantities of components - such as chromium and manganese - which can lower the 5.0 mg/m<sup>3</sup> maximum exposure guideline for general welding fume.

BEFORE USE, READ AND UNDERSTAND THE SAFETY DATA SHEET (SDS) FOR THIS PRODUCT AND SPECIFIC INFORMATION PRINTED ON THE PRODUCT CONTAINER.



# ULTRACORE® 316L

Stainless | AWS E316T0-1, E316T0-4, E316LT0-1, E316LT0-4

## KEY FEATURES

- Precision layer wound winding delivers steady spool payoff and more consistent feeding
- Smooth arc action with minimal spatter reduces post-weld cleaning
- Polished weld bead appearance reduces post-weld brushing

## WELDING POSITIONS

Flat & Horizontal

## RECOMMENDED FLUX

N/A

## CONFORMANCES

- AWS A5:** E316LT0-1, E316LT0-4  
**ABS:** E316LT0-1, E316LT0-4  
**CWB/CSA:** E316LT0-1, E316LT0-4

## TYPICAL APPLICATIONS

- 1.5 – 3% Mo austenitic stainless steel
- Suitable for Ti or Nb stabilized and nitrogen-bearing versions of the above alloys
- Applications requiring good resistance to pitting and general corrosion

## SHIELDING GAS

- FCAW-G:** 75% Ar/25% CO<sub>2</sub>  
 100% CO<sub>2</sub>

## DIAMETERS / PACKAGING

Diameter in (mm)	33 lb (15 kg) Plastic Spool (Vacuum Sealed Foil Bag)
0.045 (1.1)	ED037122
1/16 (1.6)	ED037123

## MECHANICAL PROPERTIES<sup>(1)</sup>

	Yield Strength <sup>(2)</sup> MPa (ksi)	Tensile Strength MPa (ksi)	Elongation %	Ferrite Number
<b>Requirements</b>				
AWS E316LT0-1, E316LT0-4	Not Specified	520 (75) min	30 min	Not Specified
AWS E316T0-1, E316T0-4	Not Specified	550 (80) min	30 min	Not Specified
<b>Typical Results<sup>(3)</sup></b>				
As-Welded with 100% CO <sub>2</sub>	414 (60)	552 (80)	34	6-8
As-Welded with 75% Ar/25% CO <sub>2</sub>	421 (65)	565 (82)	34	8-11

<sup>(1)</sup>Typical all weld metal, DC+ <sup>(2)</sup> Measured with 0.2% offset <sup>(3)</sup> See test results disclaimer

**DEPOSIT COMPOSITION<sup>(1)</sup>**

	%C <sup>(4)</sup>	%Mn	%Si	%S	%P
<b>Requirements</b> AWS E316LT0-1 & E316LT0-4	0.04 max	0.5-2.5	1.0 max	0.03 max	0.04 max
<b>Typical Results<sup>(3)</sup></b> As-Welded with 100% CO <sub>2</sub>	≤0.03	1.0	0.6	≤ 0.01	≤ 0.02
As-Welded with 75% Ar/25% CO <sub>2</sub>	≤0.03	1.1	0.7	≤ 0.01	≤ 0.02
	%Ni	%Cr	%Mo	%Cu	%Bi
<b>Requirements</b> AWS E316LT0-1 & E316LT0-4	11.0-14.0	17.0-20.0	2.0-3.0	0.75 max	—
<b>Typical Results<sup>(3)</sup></b> As-Welded with 100% CO <sub>2</sub>	12.3-12.5	18.0-18.5	2.5-2.8	≤ 0.25	0.02
As-Welded with 75% Ar/25% CO <sub>2</sub>	12.3-12.5	18.5-19.0	2.5-2.8	≤ 0.25	0.02

<sup>(1)</sup>Typical all weld metal, DC+ <sup>(3)</sup>See test results disclaimer <sup>(4)</sup>Requirement for E316T1-1 and E316T1-4 is 0.08% max. carbon

**TYPICAL OPERATING PROCEDURES**

Diameter, Polarity, Shielding Gas in (mm)	CTWD <sup>(5)</sup> mm (in)	Wire Feed Speed/Voltage m/min (in/min)	Voltage (Volts)	Approx. Current (Amps)	Melt-Off Rate kg/hr (lb/hr)	Deposition Rate kg/hr (lb/hr)	Efficiency (%)
0.045 in (1.1 mm), DC+ 75% Ar/25% CO <sub>2</sub>	19 (3/4)	5.3 (210)	22-24	130	2.2 (4.8)	1.9 (4.1)	85.4
	19 (3/4)	8.9 (350)	24-26	175	3.7 (8.2)	3.2 (7.0)	85.3
	19 (3/4)	11.4 (450)	26-28	210	4.6 (10.1)	4.1 (9.0)	89.1
1/16 in (1.6 mm), DC+ 75% Ar/25% CO <sub>2</sub>	25 (1)	3.6 (140)	23-25	155	2.7 (5.9)	2.3 (5.0)	84.7
	25 (1)	6.4 (250)	25-27	230	4.8 (10.6)	4.3 (9.4)	88.6
	25 (1)	8.1 (320)	26-28	280	6.2 (13.6)	5.5 (12.1)	88.9

<sup>(5)</sup>To estimate ESO, subtract 1/4 in (6.0 mm) from CTWD. NOTE: Increase Voltage by 2V when using 100% CO<sub>2</sub>

IMPORTANT: SPECIAL VENTILATION AND/OR EXHAUST REQUIRED

Fumes from the normal use of some welding products can contain significant quantities of components - such as chromium and manganese - which can lower the 5.0 mg/m<sup>3</sup> maximum exposure guideline for general welding fume.

BEFORE USE, READ AND UNDERSTAND THE SAFETY DATA SHEET (SDS) FOR THIS PRODUCT AND SPECIFIC INFORMATION PRINTED ON THE PRODUCT CONTAINER.

# ULTRACORE® 316L P

Stainless | AWS E316T1-1, E316T1-4, E316LT1-1, E316LT1-4

## KEY FEATURES

- Precision layer wound winding delivers steady spool payoff and more consistent feeding
- Smooth arc action with minimal spatter reduces post-weld cleaning
- Polished weld bead appearance reduces post-weld brushing

## WELDING POSITIONS

All Positions

## RECOMMENDED FLUX

N/A

## CONFORMANCES

- AWS A5:** E316LT1-1, E316LT1-4  
**ABS:** E316LT1-1, E316LT1-4  
**CWB/CSA:** E316LT1-1, E316LT1-4

## TYPICAL APPLICATIONS

- 1.5 – 3% Mo austenitic stainless steel
- Suitable for Ti or Nb stabilized and nitrogen-bearing versions of the above alloys
- Applications requiring good resistance to pitting and general corrosion

## SHIELDING GAS

- FCAW-G:** 75% Ar/25% CO<sub>2</sub>  
 100% CO<sub>2</sub>

## DIAMETERS / PACKAGING

Diameter in (mm)	33 lb (15 kg) Plastic Spool (Vacuum Sealed Foil Bag)
0.045 (1.1)	ED037129
1/16 (1.6)	ED037130

## MECHANICAL PROPERTIES<sup>(1)</sup>

	Yield Strength <sup>(2)</sup> MPa (ksi)	Tensile Strength MPa (ksi)	Elongation %	Ferrite Number
<b>Requirements</b>				
AWS E316LT1-1, E316LT1-4	Not Specified	520 (75) min	30 min	Not Specified
AWS E316T1-1, E316T1-4	Not Specified	550 (80) min	30 min	Not Specified
<b>Typical Results<sup>(3)</sup></b>				
As-Welded with 100% CO <sub>2</sub>	414 (60)	552 (80)	34	6-8
As-Welded with 75% Ar/25% CO <sub>2</sub>	421 (65)	565 (82)	34	8-11

<sup>(1)</sup>Typical all weld metal, DC+ <sup>(2)</sup> Measured with 0.2% offset <sup>(3)</sup> See test results disclaimer

**DEPOSIT COMPOSITION<sup>(1)</sup>**

	%C <sup>(4)</sup>	%Mn	%Si	%S	%P
<b>Requirements</b> AWS E316LT1-1 & E316LT1-4	0.04 max	0.5-2.5	1.0 max	0.03 max	0.04 max
<b>Typical Results<sup>(3)</sup></b> As-Welded with 100% CO <sub>2</sub>	≤0.03	1.0	0.6	≤ 0.01	≤ 0.02
As-Welded with 75% Ar/25% CO <sub>2</sub>	≤0.03	1.1	0.7	≤ 0.01	≤ 0.02
	%Ni	%Cr	%Mo	%Cu	%Bi
<b>Requirements</b> AWS E316LT1-1 & E316LT1-4	11.0-14.0	17.0-20.0	2.0-3.0	0.75 max	—
<b>Typical Results<sup>(3)</sup></b> As-Welded with 100% CO <sub>2</sub>	12.3-12.5	18.0-18.5	2.5-2.8	≤ 0.25	0.01
As-Welded with 75% Ar/25% CO <sub>2</sub>	12.3-12.5	18.5-19.0	2.5-2.8	≤ 0.25	0.01

<sup>(1)</sup>Typical all weld metal, DC+ <sup>(3)</sup>See test results disclaimer <sup>(4)</sup>Requirement for E316T1-1 and E316T1-4 is 0.08% max. carbon

**TYPICAL OPERATING PROCEDURES**

Diameter, Polarity, Shielding Gas in (mm)	CTWD <sup>(5)</sup> mm (in)	Wire Feed Speed/Voltage m/min (in/min)	Voltage (Volts)	Approx. Current (Amps)	Melt-Off Rate kg/hr (lb/hr)	Deposition Rate kg/hr (lb/hr)	Efficiency (%)
0.045 in (1.1 mm), DC+ 75% Ar/25% CO <sub>2</sub>	19 (3/4)	5.1 (200)	22-24	130	2.0 (4.5)	1.5 (3.3)	73.3
	19 (3/4)	8.4 (330)	24-26	180	3.3 (7.3)	2.6 (5.8)	79.4
	19 (3/4)	11.2 (440)	26-28	220	4.4 (9.7)	3.6 (7.9)	81.4
1/16 in (1.6 mm), DC+ 75% Ar/25% CO <sub>2</sub>	25 (1)	3.6 (140)	24-26	170	2.6 (5.7)	2.2 (4.8)	84.2
	25 (1)	5.0 (195)	24-26	200	3.6 (7.9)	3.0 (6.7)	84.8
	25 (1)	7.1 (280)	25-27	220	5.2 (11.4)	4.4 (9.7)	85

<sup>(5)</sup>To estimate ESO, subtract 1/4 in (6.0 mm) from CTWD. NOTE: Increase Voltage by 2V when using 100% CO<sub>2</sub>

IMPORTANT: SPECIAL VENTILATION AND/OR EXHAUST REQUIRED

Fumes from the normal use of some welding products can contain significant quantities of components - such as chromium and manganese - which can lower the 5.0 mg/m<sup>3</sup> maximum exposure guideline for general welding fume.

BEFORE USE, READ AND UNDERSTAND THE SAFETY DATA SHEET (SDS) FOR THIS PRODUCT AND SPECIFIC INFORMATION PRINTED ON THE PRODUCT CONTAINER.

# SUPERCORE™ 308LCF

Stainless ▪ AWS E308LT1-1/4 J

## KEY FEATURES

- Controlled Low Ferrite (Range 3-6)
- Charpy V-Notch test results capable of exceeding 27 J (20 ft•lbf) @ -196 °C (-320 °F)
- Exceeds 15 mils (0.38 mm) of lateral expansion @ -196 °C (-320 °F)
- Q2 Lot® - Certificates showing deposit composition, ferrite number, and charpy impact properties tested @ -196 °C (-320 °F)
- Batch Managed Inventory

## WELDING POSITIONS

All

## CONFORMANCES

AWS A5.22: E308LT1-1/4 J

ASME SFA 5.22: E308LT1-1/4 J

## TYPICAL APPLICATIONS

- LNG Storage
- Cryogenic Vessels and Piping

## TYPICAL BASE METALS

- 304L stainless steel
- 18/8 steels with service temperatures down to -196 °C (-320 °F)

## SHIELDING GAS

80% Argon / 20% CO<sub>2</sub> or 100% CO<sub>2</sub>

## DIAMETERS / PACKAGING

Diameter in (mm)	33 lb (15 kg) Spool
0.045 (1.2)	ED034815, SC308LCF-12*

\*The Metrode part number will be replacing the current EDO numbers after the inventory has been depleted.

## MECHANICAL PROPERTIES<sup>(1)</sup> – As Required per AWS A5.22

	Yield Strength <sup>(2)</sup> MPa (ksi)	Tensile Strength MPa (ksi)	Elongation %	Charpy V-Notch J (ft•lb) -196 °C (-320 °F)	Lateral Expansion mm (mils) -196 °C (-320 °F)
<b>Requirements</b> AWS A5.22: E308LT1-1/4 J As-Welded with 80% Ar/20% CO <sub>2</sub>	Not Specified	520 (75) min	30 min	Not Specified	0.38 (15)
<b>Typical Results<sup>(3)</sup></b> As-Welded with 80% Ar/20% CO <sub>2</sub>	400 (58)	540 (78)	50	36 (27)	0.70 (28)

## DEPOSIT COMPOSITION<sup>(1)</sup> – As Required per AWS A5.22

	%C	%Mn	%Si	%S	%P
<b>Requirements</b> As-Welded with 80% Ar/20% CO <sub>2</sub>	0.04 max	0.5 - 2.5	1.0 max	0.03 max	0.04 max
<b>Typical Results<sup>(3)</sup></b>	0.03	1.4	0.6	0.01	0.02
	%Cr	%Ni	%Mo	%Cu	%FN
<b>Requirements</b> As-Welded with 80% Ar/20% CO <sub>2</sub>	18.0-21.0	9.0-11.0	0.75	0.75	Not Specified
<b>Typical Results<sup>(3)</sup></b>	18.6	10.5	0.1	0.1	3

## TYPICAL OPERATING PROCEDURES

Diameter, Polarity Shielding Gas	CTWD <sup>(5)</sup> mm (in)	Wire Feed Speed m/min (in/min)	Voltage (Volts)	Approx. Current (Amps)	Melt-Off Rate kg/hr (lb/hr)	Deposition Rate kg/hr (lb/hr)	Efficiency (%)
0.045 in (1.1 mm), DC+ 75% Ar/25% CO <sub>2</sub>	19 (3/4)	5.1 (200)	23-26	120	2.1 (4.7)	1.8 (4.0)	85
	19 (3/4)	7.6 (300)	25-28	155	3.2 (7.0)	2.7 (6.0)	86
	19 (3/4)	10.2 (400)	27-30	185	4.3 (9.4)	3.6 (7.9)	84

<sup>(1)</sup>Typical all weld metal <sup>(2)</sup>Measured with 0.2% offset <sup>(3)</sup>See test results disclaimer

IMPORTANT: SPECIAL VENTILATION AND/OR EXHAUST REQUIRED
Fumes from the normal use of some welding products can contain significant quantities of components - such as chromium and manganese - which can lower the 5.0 mg/m <sup>3</sup> maximum exposure guideline for general welding fume.
BEFORE USE, READ AND UNDERSTAND THE SAFETY DATA SHEET (SDS) FOR THIS PRODUCT AND SPECIFIC INFORMATION PRINTED ON THE PRODUCT CONTAINER.

# SUPERCORE™ 316LCF

Stainless ▪ AWS E316LT1-1/4 J

## KEY FEATURES

- Controlled Low Ferrite (Range 3-5)
- Charpy V-Notch test results capable of exceeding 27 J (20 ft•lbf) @ -196°C (-320°F)
- Exceeds 15 mils (0.38 mm) of lateral expansion @ -196°C (-320°F)
- Q2 Lot® - Certificates showing deposit composition, ferrite number, and charpy impact properties tested @ -196°C (-320°F)
- Batch Managed Inventory

## WELDING POSITIONS

All

## DIAMETERS / PACKAGING

Diameter in (mm)	33 lb (15 kg) Spool
0.045 (1.2)	ED034816, SC316LCF-12*

\*The Metrode part number will be replacing the current EDO numbers after the inventory has been depleted.

## CONFORMANCES

AWS A5.22: E316LT1-1/4 J

ASME SFA 5.22: E316LT1-1/4 J

## TYPICAL APPLICATIONS

- LNG Storage
- Cryogenic Vessels and Piping

## TYPICAL BASE METALS

316L stainless steel

## SHIELDING GAS

80% Argon/20% CO<sub>2</sub> or 100% CO<sub>2</sub>

## MECHANICAL PROPERTIES<sup>(1)</sup> – As Required per AWS A5.22

	Yield Strength <sup>(2)</sup> MPa (ksi)	Tensile Strength MPa (ksi)	Elongation %	Charpy V-Notch J (ft•lb) -196°C (-320°F)	Lateral Expansion mm (mils) -196°C (-320°F)
<b>Requirements</b> AWS E316LT1-1/4 J As-Welded with 80% Ar/20% CO <sub>2</sub>	Not Specified	485 (70) min	30 min	Not Specified	0.38 (15)
<b>Typical Results<sup>(3)</sup></b> As-Welded with 80% Ar/20% CO <sub>2</sub>	410 (69)	550 (80)	40	34 (25)	0.55 (22)

## DEPOSIT COMPOSITION<sup>(1)</sup> – As Required per AWS A5.22

	%C	%Mn	%Si	%S	%P
<b>Requirements</b> As-Welded with 80% Ar/20% CO <sub>2</sub>	0.04 max	0.5-2.5	1.0 max	0.03 max	0.04 max
<b>Typical Results<sup>(3)</sup></b>	0.03	1.4	0.6	0.01	0.02
	%Cr	%Ni	%Mo	%Cu	%FN
<b>Requirements</b> As-Welded with 80% Ar/20% CO <sub>2</sub>	17.0-20.0	11.0-14.0	2.0-3.0	0.75	Not Specified
<b>Typical Results<sup>(3)</sup></b>	18.0	12.4	2.2	0.1	3

## TYPICAL OPERATING PROCEDURES

Diameter, Polarity Shielding Gas	CTWD <sup>(5)</sup> mm (in)	Wire Feed Speed m/min (in/min)	Voltage (Volts)	Approx. Current (Amps)	Melt-Off Rate kg/hr (lb/hr)	Deposition Rate kg/hr (lb/hr)	Efficiency (%)
0.045 in (1.1 mm), DC+ 75% Ar/25% CO <sub>2</sub>	19 (3/4)	5.1 (200)	23-26	120	2.1 (4.7)	1.8 (4.0)	85
	19 (3/4)	7.6 (300)	25-28	155	3.2 (7.0)	2.7 (6.0)	86
	19 (3/4)	10.2 (400)	27-30	185	4.3 (9.4)	3.6 (7.9)	84

<sup>(1)</sup>Typical all weld metal <sup>(2)</sup>Measured with 0.2% offset <sup>(3)</sup>See test results disclaimer

IMPORTANT: SPECIAL VENTILATION AND/OR EXHAUST REQUIRED
Fumes from the normal use of some welding products can contain significant quantities of components - such as chromium and manganese - which can lower the 5.0 mg/m <sup>3</sup> maximum exposure guideline for general welding fume.
BEFORE USE, READ AND UNDERSTAND THE SAFETY DATA SHEET (SDS) FOR THIS PRODUCT AND SPECIFIC INFORMATION PRINTED ON THE PRODUCT CONTAINER.

# SUPERCORE™ 347

Stainless ▪ AWS E347T0-1/4

## KEY FEATURES

- High deposition flat / horizontal wire
- Improved bead appearance
- Q2 Lot® - Certificate showing deposit composition, ferrite number, and Charpy impact properties tested @ -196°C (-320°F)

## WELDING POSITIONS

Flat and horizontal

## SHIELDING GAS

75-80% Argon / Balance CO<sub>2</sub>  
100% CO<sub>2</sub>

## CONFORMANCES

**AWS A5.22** E347T0-1/4  
**BS EN ISO 17633-A** T19 9 Nb R C/M 3  
**BS EN ISO 17633-B** TS347-FB0

## TYPICAL APPLICATIONS

- Food
- Brewery
- Pharmaceutical Equipment
- Architectural
- General Fabrication

## DIAMETERS / PACKAGING

Diameter in (mm)	33 lb (15 kg) Spool
0.045 (1.2)	ED034129, SC347-12*

\*The Metrode part number will be replacing the current ED0 numbers after the inventory has been depleted.

## MECHANICAL PROPERTIES<sup>(1)</sup> - As Required per AWS A5.22

	Yield Strength <sup>(2)</sup> MPa (ksi)	Tensile Strength MPa (ksi)	Elongation %	Charpy V-Notch J (ft·lbf) @ 20°C (68°F)
<b>Requirements</b> AWS E347T0-1/4	Not Specified	520 (75)	30 min	-
<b>Typical Results<sup>(3)</sup></b> As-Welded	435 (63)	600 (87)	47	90 (67)

## DEPOSIT COMPOSITION<sup>(1)</sup> - As Required per AWS A5.22

	%C	%Mn	%Si	%S	%P	%Cr
<b>Requirements</b> AWS E347T0-1/4	0.08 max	0.5-2.5	1.0 max	0.03 max	0.04 max	18.0-21.0
<b>Typical Results<sup>(3)</sup></b>	0.03	1.2	0.4	0.01	0.02	19
	%Ni	%Mo	%Nb	%Cu	FN	
<b>Requirements</b> AWS E347T0-1/4	9.0-11.0	0.75 max	8 x C min - 1.0 max	0.75 max	4 - 12	
<b>Typical Results<sup>(3)</sup></b>	10.5	0.1	0.5	0.1	8.0	

## TYPICAL OPERATING PROCEDURES

Diameter mm (in)	Amp-Volt Range	Typical	Stickout mm (in)
1.2 (0.045) DC+	120-280A 22-34V	180A, 29V	15 - 20 (5/8 - 1)

<sup>(1)</sup>Typical all weld metal. <sup>(2)</sup>Measured with 0.2% offset. <sup>(3)</sup>See test results disclaimer  
NOTE: Additional test data available upon request.

<p>IMPORTANT: SPECIAL VENTILATION AND/OR EXHAUST REQUIRED</p> <p>Fumes from the normal use of some welding products can contain significant quantities of components - such as chromium and manganese - which can lower the 5.0 mg/m<sup>3</sup> maximum exposure guideline for general welding fume.</p> <p>BEFORE USE, READ AND UNDERSTAND THE SAFETY DATA SHEET (SDS) FOR THIS PRODUCT AND SPECIFIC INFORMATION PRINTED ON THE PRODUCT CONTAINER.</p>
--

# SUPERCORE® 2205P

Stainless ▪ AWS E2209T1-1/4

## KEY FEATURES

- Smooth all position weldability
- Vacuum sealed pack
- Excellent slag removal
- Q2 Lot® – Certificate showing deposit composition, ferrite number, and charpy impact properties tested (@ -196°C (-320°F))

## WELDING POSITIONS

All

## SHIELDING GAS

80% Argon / 20% CO<sub>2</sub>  
100% CO<sub>2</sub>

## DIAMETERS / PACKAGING

Diameter mm (in)	15 kg (33 lb) Spool
1.2 (0.045)	SC2205P-12

## MECHANICAL PROPERTIES<sup>(1)</sup> - As Required per AWS A5.22

	Yield Strength <sup>(2)</sup> MPa (ksi)	Tensile Strength MPa (ksi)	Elongation %	Charpy V-Notch J (ft·lbf)			Hardness HV <sub>10</sub> <sup>(4)</sup>
				@ -20°C (-40°F)	@ -50°C (-58°F)	@ -75°C (-103°F)	
<b>Requirements</b> AWS E2209T1-1/4	Not Specified	690 (100)	20 min	–	–	–	–
<b>Typical Results<sup>(3)</sup></b> As-Welded	630 (91)	800 (116)	32	65 (48)	55 (41)	30 (22)	270

## DEPOSIT COMPOSITION<sup>(1)</sup> - As Required per AWS A5.22

	%C	%Mn	%Si	%S	%P	%Cr
<b>Requirements</b> AWS E2209T1-1/4	0.04 max	0.5-2.0	1.0 max	0.03 max	0.04 max	21.0 - 24.0
<b>Typical Results<sup>(3)</sup></b>	0.03	1.2	0.7	<0.01	0.02	23
	%Ni	%Mo	%Cu	%N	PRE <sup>(5)</sup>	
<b>Requirements</b> AWS E2209T1-1/4	7.5-10.0	2.5-4.0	0.75 max	0.08-0.20	Not Specified	
<b>Typical Results<sup>(3)</sup></b>	9.2	3.1	0.1	0.12	35.0	

## TYPICAL OPERATING PROCEDURES<sup>(6)</sup>

Diameter mm (in)	Voltage (volts)	Amperage (amps)	Typical	CTWD mm (in)
1.2 (0.045) DC+	22-34	120-250	150A / 25V	15-20 (5/8 - 1)

<sup>(1)</sup>Typical all weld metal. <sup>(2)</sup>Measured with 0.2% offset. <sup>(3)</sup>See test results disclaimer. <sup>(4)</sup>Industry specific data, not required by AWS. <sup>(5)</sup>PRE (Pitting Resistance Equivalent)= Cr + 3.3Mo+16N.

<sup>(6)</sup>Procedures are for 80% Argon/20% CO<sub>2</sub>. Increase voltage by approximately 3V for 100% CO<sub>2</sub>. NOTE: Additional test data available upon request.

IMPORTANT: SPECIAL VENTILATION AND/OR EXHAUST REQUIRED
Fumes from the normal use of some welding products can contain significant quantities of components - such as chromium and manganese - which can lower the 5.0 mg/m <sup>3</sup> maximum exposure guideline for general welding fume.
BEFORE USE, READ AND UNDERSTAND THE SAFETY DATA SHEET (SDS) FOR THIS PRODUCT AND SPECIFIC INFORMATION PRINTED ON THE PRODUCT CONTAINER.



# SUPERCORE™ 2507

Stainless ▪ AWS E2594T0-4

## KEY FEATURES

- Exceptional bead appearance
- High deposition rates
- Vacuum sealed pack
- Q2 Lot® - Certificate showing deposit composition, ferrite number, and charpy impact properties tested @ -196°C (-320°F)
- High resistance to chloride infused stress corrosion cracking
- Use on 25% Cr super duplex stainless steel

## WELDING POSITIONS

Flat and Horizontal

## CONFORMANCES

**AWS A5.22:** E2594T0-4  
**EN ISO 17633-A:** T25 9 4 N L R M21 3

## TYPICAL INDUSTRY SEGMENTS

- Duplex Stainless Steel Pipe, Plate, Fittings and Forgings
- Offshore
- Chemical / Petrochemical

## SHIELDING GAS

80% Argon / 20%CO<sub>2</sub>

## DIAMETERS / PACKAGING

Diameter in (mm)	33 lb (15 kg) Spool
0.045 (1.2)	EDO33529

## MECHANICAL PROPERTIES<sup>(1)</sup> - As Required per AWS A5.22

	Yield Strength <sup>(2)</sup> MPa (ksi)	Tensile Strength MPa (ksi)	Elongation %		Charpy V-Notch J (ft-lbf)			Hardness HV <sub>10</sub> <sup>(4)</sup>
			4.0 dia	5.0 dia	@ -20°C (-40°F)	@ -50°C (-58°F)	@ 20°C (68°F)	
<b>Requirements</b> AWS E2594T0-4	Not Specified	760 min (110)	15 min	18 min	—	—	—	—
<b>Typical Results<sup>(3)</sup></b> As-Welded	660 (96)	870 (126)	30	29	35 (26)	30 (22)	45 (35)	300

## DEPOSIT COMPOSITION<sup>(1)</sup> - As Required per AWS A5.22

	%C	%Mn	%Si	%S	%P	%Cr
<b>Requirements</b> AWS E2594T0-4	0.04 max	0.5-2.5	1.0 max	0.03 max	0.04 max	24.0-27.0
<b>Typical Results<sup>(3)</sup></b>	0.03	1.0	0.50	0.01	0.02	24.5
	%Ni	%Mo	%Cu	%W	%N	PRE <sup>(5)</sup>
<b>Requirements</b> AWS E2594T0-4	8.0-10.5	2.5-4.5	1.5 max	1.0 max	0.20-0.30	Not Specified
<b>Typical Results<sup>(3)</sup></b>	9.3	3.8	0.05	0.05	0.23	41

## TYPICAL OPERATING PROCEDURES

Diameter mm (in)	Amp-Volt Range	Typical	Stickout mm (in)
1.2 (0.045) DC+	120-280A, 22-34V	180A, 29V	15-20 (5/8-1)

<sup>(1)</sup>Typical all weld metal. <sup>(2)</sup>Measured with 0.2% offset. <sup>(3)</sup>See test results disclaimer <sup>(4)</sup>Industry specific data, not required by AWS. <sup>(5)</sup>PRE (Pitting Resistance Equivalent) = Cr + 3.3Mo + 16N.  
 NOTE: Additional test data available upon request.

<p>IMPORTANT: SPECIAL VENTILATION AND/OR EXHAUST REQUIRED</p> <p>Fumes from the normal use of some welding products can contain significant quantities of components - such as chromium and manganese - which can lower the 5.0 mg/m<sup>3</sup> maximum exposure guideline for general welding fume.</p> <p>BEFORE USE, READ AND UNDERSTAND THE SAFETY DATA SHEET (SDS) FOR THIS PRODUCT AND SPECIFIC INFORMATION PRINTED ON THE PRODUCT CONTAINER.</p>
--

# SUPERCORE™ 2507P

Stainless ▪ AWS E2594T1-4

## KEY FEATURES

- Use on 25% Cr super duplex stainless steel
- Exceptional bead appearance
- High deposition rates
- Vacuum sealed pack
- High resistance to chloride induced stress corrosion cracking
- Q2 Lot® - Certificate showing deposit composition, ferrite number, and charpy impact properties tested @ -196°C (-320°F)

## WELDING POSITIONS

All

## DIAMETERS / PACKAGING

Diameter in (mm)	33 lb (15 kg) Spool
0.045 (1.2)	ED033530, SC2507P-12*

\*The Metrode part number will be replacing the current EDO numbers after the inventory has been depleted.

## CONFORMANCES

<b>AWS A5.22:</b>	E2594T1-4
<b>EN ISO 17633-A:</b>	T25 9 4 N L R M21 2

## TYPICAL INDUSTRY SEGMENTS

- Duplex Stainless Steel Plates and Vessels
- Duplex Stainless Steel Pipe and Fittings
- Offshore
- Chemical/Petrochemical

## SHIELDING GAS

80% Argon / 20% CO<sub>2</sub>

## MECHANICAL PROPERTIES<sup>(1)</sup> - As Required per AWS A5.22

	Yield Strength <sup>(2)</sup> MPa (ksi)	Tensile Strength MPa (ksi)	Elongation %	Charpy V-Notch J (ft-lbf)		
				@ 20°C (68°F)	@ -20°C (-40°F)	@ -50°C (-58°F)
<b>Requirements</b> AWS E2594T1-4	Not Specified	760 (110) min	15 min	-	-	-
<b>Typical Results<sup>(3)</sup></b> As-Welded	660 (96)	870 (126)	30	60 (44)	45 (33)	35 (26)

## DEPOSIT COMPOSITION<sup>(1)</sup> - As Required per AWS A5.22

	%C	%Mn	%Si	%S	%P	%Cr
<b>Requirements</b> AWS E2594T1-4	0.04 max	0.5-2.5	1.0 max	0.03 max	0.04 max	24.0-27.0
<b>Typical Results<sup>(3)</sup></b>	0.03	1.0	0.50	0.01	0.02	24.5
	%Ni	%Mo	%Cu	%W	%N	PRE <sup>(5)</sup>
<b>Requirements</b> AWS E2594T1-4	8.0-10.5	2.5-4.5	1.5 max	1.0 max	0.20-0.30	40 min
<b>Typical Results<sup>(3)</sup></b>	9.3	3.8	0.05	0.05	0.23	41

## TYPICAL OPERATING PROCEDURES

Diameter mm (in)	Amp-Volt Range	Typical	Stickout mm (in)
1.2 (0.045) DC+	120-250A, 22-32V	150A, 25V	15-20 (5/8-1)

<sup>(1)</sup>Typical all weld metal. <sup>(2)</sup>Measured with 0.2% offset. <sup>(3)</sup>See test results disclaimer <sup>(4)</sup>Industry specific data, not required by AWS. <sup>(5)</sup>PRE (pitting resistance equivalent) = Cr + 3.3Mo + 16N.  
NOTE: Additional test data available upon request.

<p>IMPORTANT: SPECIAL VENTILATION AND/OR EXHAUST REQUIRED</p> <p>Fumes from the normal use of some welding products can contain significant quantities of components - such as chromium and manganese - which can lower the 5.0 mg/m<sup>3</sup> maximum exposure guideline for general welding fume.</p> <p>BEFORE USE, READ AND UNDERSTAND THE SAFETY DATA SHEET (SDS) FOR THIS PRODUCT AND SPECIFIC INFORMATION PRINTED ON THE PRODUCT CONTAINER.</p>
--

# SUPERCORE™ 308HP

Stainless ▪ AWS E308HT1 - 1/4

## KEY FEATURES

- Designed for strength and resistance to corrosion
- Used for joining austenitic stainless steels used at elevated temperatures
- Enhanced carbon electrode for high temperature applications
- Higher carbon content for high temperature applications

## WELDING POSITIONS

All

## SHIELDING GAS

80% Argon / 20% CO  
100% CO<sub>2</sub>

## CONFORMANCES

AWS A5.22: E308HT1 - 1/4  
EN ISO 17633-B TS308H-FB1

## TYPICAL APPLICATIONS

- Marine
- Chemical process
- Papermaking
- Food processing
- Petrochemical

## DIAMETERS / PACKAGING

Diameter in (mm)	33 lb (15 kg) Spool
0.045 (1.2)	ED034938, SC308HP-12*

\* The Metrode part number will be replacing the current EDO numbers after the inventory has been depleted.

## MECHANICAL PROPERTIES<sup>(1)</sup> – As Required per AWS A5.22

	Yield Strength <sup>(2)</sup> MPa (ksi)	Tensile Strength MPa (ksi)	Elongation %	Charpy V-Notch J (ft•lbf)	
				@-20°C (-4°F)	@-50°C (-58°F)
<b>Requirements</b> AWS E308HT1-1/4 As-Welded	-	550 (80)	30 min	-	-
<b>Typical Results<sup>(3)</sup></b> As-Welded	420 (61)	620 (90)	40	100 (74)	

## DEPOSIT COMPOSITION<sup>(1)</sup> – As Required per AWS A5.22

	%C	%Mn	%Si	%S	%P
<b>Requirements</b> AWS E308HT1-1/4	0.04-0.08	0.5 - 2.5	1.0 max	0.03 max	0.04 max
<b>Typical Results<sup>(3)</sup></b>	0.05	1.3	0.5	0.01	0.02
	%Cr	%Ni	%Mo	%Cu	FN
<b>Requirements</b> AWS E308HT1-1/4	18.0 - 21.0	9.0-11.0	0.75 max	0.75 max	Not Specified
<b>Typical Results<sup>(3)</sup></b>	18.8	9.5	0.1	0.1	5

## TYPICAL OPERATING PROCEDURES

Diameter mm (in)	Amp Range	Volt Range	Stickout mm (in)
1.2 (0.045) DC+	120-250	22-32	12 - 20 (1/2-1)

<sup>(1)</sup> Typical all weld metal <sup>(2)</sup> Measured with 0.2% offset <sup>(3)</sup> See test results disclaimer

<p>IMPORTANT: SPECIAL VENTILATION AND/OR EXHAUST REQUIRED</p> <p>Fumes from the normal use of some welding products can contain significant quantities of components - such as chromium and manganese - which can lower the 5.0 mg/m<sup>3</sup> maximum exposure guideline for general welding fume.</p> <p>BEFORE USE, READ AND UNDERSTAND THE SAFETY DATA SHEET (SDS) FOR THIS PRODUCT AND SPECIFIC INFORMATION PRINTED ON THE PRODUCT CONTAINER.</p>
--

# SUPERCORE™ 317LP

Stainless ▪ AWS E317LT1-1/4

## KEY FEATURES

- Used to weld 317/317L stainless steels
- Improved resistance to pitting in high chloride environments

## WELDING POSITIONS

All

## SHIELDING GAS

80% Argon / 20% CO  
100% CO<sub>2</sub>

## CONFORMANCES

AWS A5.22: E317LT1-1/4  
EN ISO 17633-B TS317L-FB1

## TYPICAL APPLICATIONS

- Marine
- Chemical process
- Papermaking
- Food processing

## DIAMETERS / PACKAGING

Diameter in (mm)	33 lb (15 kg) Spool
0.045 (1.2)	ED035491, SC317LP-12*

\*The Metrode part number will be replacing the current EDO numbers after the inventory has been depleted.

## MECHANICAL PROPERTIES<sup>(1)</sup> – As Required per AWS A5.22

	Yield Strength <sup>(2)</sup> MPa (ksi)	Tensile Strength MPa (ksi)	Elongation %	Charpy V-Notch J (ft·lbf)		Hardness HV
				@20°C (68°F)	@-50°C (-58°F)	
<b>Requirements</b> AWS E317LT1-1/4 As-Welded	Not Specified	520 (75)	20 min	-	-	-
<b>Typical Results<sup>(3)</sup></b> As-Welded	440 (64)	570 (83)	27	30 (22)	55 (41)	220

## DEPOSIT COMPOSITION<sup>(1)</sup> – As Required per AWS A5.22

	%C	%Mn	%Si	%S	%P	%Cr
<b>Requirements</b> AWS E317LT1-1/4	0.04 max	0.5-2.5	1.0 max	0.3 max	0.04 max	18.0-21.0
<b>Typical Results<sup>(3)</sup></b>	0.03	1.0	0.6	0.02	0.02	19.0
	%Ni	%Mo	%Cu	%N	FN	
<b>Requirements</b> AWS E317LT1-1/4	12.0-14.0	3.0-4.0	0.75 max	Not Specified	Not specified	
<b>Typical Results<sup>(3)</sup></b>	13	3.5	0.1	0.07	6	

## TYPICAL OPERATING PROCEDURES

Diameter mm (in)	Amp Range	Volt Range	Stickout mm (in)
1.2 (0.045) DC+	120-280	22-34	15-20 (5/8-1)

<sup>(1)</sup> Typical all weld metal <sup>(2)</sup> Measured with 0.2% offset <sup>(3)</sup> See test results disclaimer

<p>IMPORTANT: SPECIAL VENTILATION AND/OR EXHAUST REQUIRED</p> <p>Fumes from the normal use of some welding products can contain significant quantities of components - such as chromium and manganese - which can lower the 5.0 mg/m<sup>3</sup> maximum exposure guideline for general welding fume.</p> <p>BEFORE USE, READ AND UNDERSTAND THE SAFETY DATA SHEET (SDS) FOR THIS PRODUCT AND SPECIFIC INFORMATION PRINTED ON THE PRODUCT CONTAINER.</p>
--

# SUPERCORE™ 16.8.2P

Stainless

## KEY FEATURES

- Suited for the most demanding vertical and overhead welding applications, including fixed pipework for ASME

## CONFORMANCES

BS EN ISO 17633-B  
(Nearest TS16-8-2-FM1)

## WELDING POSITIONS

All

## SHIELDING GAS

80% Argon / 20% CO

## TYPICAL APPLICATIONS

- Furnace parts
- Gas and steam turbine
- Petrochemical
- Chemical process plants
- Power generation industries

## DIAMETERS / PACKAGING

Diameter in (mm)	33 lb (15 kg) Spool
0.045 (1.2)	SC1682P-12

## MECHANICAL PROPERTIES<sup>(1)</sup>

	Yield Strength <sup>(2)</sup> MPa (ksi)	Tensile Strength MPa (ksi)	Elongation %		Charpy V-Notch J (ft-lbf)		Hardness HV
			4.0 dia	5.0 dia	@-20°C (-4°F)	@-196°C (-320°F)	
Typical Results <sup>(3)</sup> As-Welded	410 (59)	620 (90)	42	42	100 (74)	45 (33)	-

## DEPOSIT COMPOSITION<sup>(1)</sup>

	%C	%Mn	%Si	%S	%P
Typical Results <sup>(3)</sup>	0.05	1.2	0.5	0.01	0.02
	%Cr	%Ni	%Mo	%Cu	FN
Typical Results <sup>(3)</sup>	16.2	9.2	1.1	0.1	4

## TYPICAL OPERATING PROCEDURES

Diameter mm (in)	Amp-Volt Range	Volt Range	Typical	Stickout mm (in)
1.2 (0.045) DC+	120-280A	22-34V	180A, 29V	15-20 (5/8-1)

<sup>(1)</sup> Typical all weld metal <sup>(2)</sup> Measured with 0.2% offset <sup>(3)</sup> See test results disclaimer

IMPORTANT: SPECIAL VENTILATION AND/OR EXHAUST REQUIRED

Fumes from the normal use of some welding products can contain significant quantities of components - such as chromium and manganese - which can lower the 5.0 mg/m<sup>3</sup> maximum exposure guideline for general welding fume.

BEFORE USE, READ AND UNDERSTAND THE SAFETY DATA SHEET (SDS) FOR THIS PRODUCT AND SPECIFIC INFORMATION PRINTED ON THE PRODUCT CONTAINER.

# SUPERCORE™ Z100XP

Stainless ▪ AWS E2594T1-4

## KEY FEATURES

- Designed for strength and resistance to corrosion
- Used for joining supermartensitic stainless steels
- Superior resistance to stress corrosion cracking (SCC) and pitting corrosion
- The addition of Cu and W provides superior resistance to sulphuric and hydrochloric acids compared to similar alloys without these metals

## WELDING POSITIONS

All

## SHIELDING GAS

80% Argon / 20% CO

## DIAMETERS / PACKAGING

Diameter in (mm)	33 lb (15 kg) Spool
0.045 (1.2)	SCZ100XP-12

## MECHANICAL PROPERTIES<sup>(1)</sup> – As Required per AWS A5.22

	Yield Strength <sup>(2)</sup> MPa (ksi)	Tensile Strength MPa (ksi)	Elongation %	Charpy V-Notch J (ft-lbf)		Hardness HV
				@-20°C (-4°F)	@-50°C (-58°F)	
<b>Requirements</b> AWS E2594T1-4	Not specified	760 (110) min	15 min	-	-	-
<b>Typical Results<sup>(3)</sup></b>	690	880	25	40 (30)	32 (24)	280

## DEPOSIT COMPOSITION<sup>(1)</sup> – As Required per AWS A5.22

	%C	%Mn	%Si	%S	%P	%Cr
<b>Requirements</b> AWS E2594T1-4	0.04 max	0.5-2.5	1.0 max	0.03 max	0.04 max	24.0-27.0
<b>Typical Results<sup>(3)</sup></b>	0.03	1.0	0.5	0.005	0.02	24.5
	%Ni	%Mo	%Cu	%N	%W	PRE <sup>(4)</sup>
<b>Requirements</b> AWS E2594T1-4	8.0-10.5	2.5-4.5	1.5 max	0.20-0.30	1.0 max	Not specified
<b>Typical Results<sup>(3)</sup></b>	9.1	3.7	0.6	0.22	0.6	41

## TYPICAL OPERATING PROCEDURES

Diameter mm (in)	Amp Range	Volt Range	Stickout mm (in)
1.2 (0.045) DC+	120-250	22-34	15-20 (5/8-1)

<sup>(1)</sup> Typical all weld metal <sup>(2)</sup> Measured with 0.2% offset <sup>(3)</sup> See test results disclaimer <sup>(4)</sup> PRE (Pitting Resistance Equivalent) = Cr + 3.3Mo + 16N.

IMPORTANT: SPECIAL VENTILATION AND/OR EXHAUST REQUIRED

Fumes from the normal use of some welding products can contain significant quantities of components - such as chromium and manganese - which can lower the 5.0 mg/m<sup>3</sup> maximum exposure guideline for general welding fume.

BEFORE USE, READ AND UNDERSTAND THE SAFETY DATA SHEET (SDS) FOR THIS PRODUCT AND SPECIFIC INFORMATION PRINTED ON THE PRODUCT CONTAINER.

# LINCOLNWELD® 308/308L

Stainless ▪ AWS ER308, ER308L

## KEY FEATURES

- Designed to be used primarily with basic fluxes
- Versatile electrode designed to weld several types of austenitic steels
- Q2 Lot® - Certificate showing actual wire composition and calculated ferrite number (FN) available online
- Balanced chromium and nickel levels provide enough ferrite in the weld metal for high resistance to hot cracking
- Provides a weld deposit with reduced carbon levels (0.03% max) that offers increased resistance to inter-granular corrosion

## RECOMMENDED FLUXES

Lincolnweld® 801, 802, 880, 880M, 882, P2007, ST-100, P2000

## CONFORMANCES

- AWS A5:** ER308, ER308L  
**ABS:** ER308, ER308L  
**CWB/CSA:** ER308, ER308L  
**ISO:** S5308L

## TYPICAL APPLICATIONS

- ASTM A743, A744 Types CF-8 and CF-3
- ASTM A240 Types 302, 304, 304L
- For joining the more common austenitic stainless steel grades referred to as "18-8" steels
- Type 308L is ideal for welding Type 304L stainless steels

## DIAMETERS / PACKAGING

Diameter in (mm)	55 lb (25 kg) Steel Spool	500 lb (227 kg) Speed Feed® Drum	750 lb (340 kg) Speed Feed® Drum	500 lb (227 kg) Speed Feed® Reel	600 lb (272 kg) Speed Feed® Reel
1/16 (1.6)	ED035160				
5/64 (2.0)	ED033147				
3/32 (2.4)	ED035162	ED036446	ED036540	ED035161	ED034478
1/8 (3.2)	ED035163	ED036440	ED036604		
5/32 (4.0)	ED035165	ED036441*			

\*Available upon request

## MECHANICAL PROPERTIES<sup>(1)</sup> – As Required per AWS A5.9

Test Results <sup>(3, 5)</sup> - As-Welded	Yield Strength <sup>(2)</sup> MPa (ksi)	Tensile Strength MPa (ksi)	Elongation %	Ferrite Number
	380 (55)	565 (82)	42	15

## WIRE COMPOSITION<sup>(1)</sup>

	%C <sup>(4)</sup>	%Cr	%Ni	%Mo	%Mn	%Si
<b>Requirements</b> - AWS ER308, ER308L	0.03 max	19.5-22.0	9.0-11.0	0.75 max	1.0 - 2.5	0.30 - 0.65
<b>Typical Results<sup>(3)</sup></b>						
Wire Composition	0.02	20.1	9.8	0.10	1.8	0.50
All Weld Metal Composition <sup>(5)</sup>	0.02	19.0 - 19.5	9.8	0.10	1.5 - 1.9	0.50 - 0.80

## TYPICAL OPERATING PROCEDURES

Diameter in (mm)	Wire Feed Speed m/min (in/min)	Voltage (volts)	Current (amps)
5/64 (2.0)	2.0-6.1 (80-240)	24-30	190-500
3/32 (2.4)	1.5-5.3 (60-210)	26-32	195-575
1/8 (3.2)	0.9-2.8 (35-110)	28-34	200-700
5/32 (4.0)	0.8-1.9 (30-75)	30-36	320-775

<sup>(1)</sup>Typical all weld metal. <sup>(2)</sup>Measured with 0.2% offset. <sup>(3)</sup>See test results disclaimer <sup>(4)</sup>AWS Requirement for ER308 is 0.08% max. carbon.

<sup>(5)</sup>Results shown correspond with the recommended Lincolnweld® and Blue Max® fluxes listed above, but not required per AWS A5.9-93.

IMPORTANT: SPECIAL VENTILATION AND/OR EXHAUST REQUIRED
Fumes from the normal use of some welding products can contain significant quantities of components - such as chromium and manganese - which can lower the 5.0 mg/m <sup>3</sup> maximum exposure guideline for general welding fume.
BEFORE USE, READ AND UNDERSTAND THE SAFETY DATA SHEET (SDS) FOR THIS PRODUCT AND SPECIFIC INFORMATION PRINTED ON THE PRODUCT CONTAINER.

# LINCOLNWELD® 308/308H

Stainless ▪ AWS ER308H

## KEY FEATURES

- Used to weld unstabilized austenitic stainless steels such as 302, 304H and 305
- Provides a high carbon deposit (minimum of .04% carbon) for high temperature applications
- Q2 Lot® - Certificates showing actual wire chemistry available online
- The high carbon deposit provides creep strength and higher tensile strength at elevated service temperatures

## CONFORMANCES

AWS A5: ER308, ER308H

## TYPICAL APPLICATIONS

- Chemical
- Petrochemical industries
- Distillery
- Dairy
- Restaurant Equipment
- Catalytic Crackers
- Pulp and Paper

## RECOMMENDED FLUXES

P2007, P2000

## DIAMETERS / PACKAGING

Diameter in (mm)	55 lb (25 kg) Steel Spool
3/32 (2.4)	ED035158
1/8 (3.2)	ED035159

## WIRE COMPOSITION<sup>(1)</sup> – As Required per AWS A5.9

	%C	%Cr	%Ni	%Mo	%Mn
<b>Requirements</b> AWS ER308H	0.04 - 0.08	19.5 - 22.0	9.00 - 11.00	0.50 max	1.0 - 2.5
<b>Typical Results<sup>(2)</sup></b>	0.06	19.9	9.7	0.07	1.8
	%Si	%P	%S	%Cu	FN
<b>Requirements</b> AWS ER308H	0.30 - 0.65	0.04 max	0.03 max	0.75 max	Not Required
<b>Typical Results<sup>(2)</sup></b>	0.44	0.02	0.006	0.10	5 - 12

## TYPICAL OPERATING PROCEDURES

Diameter in (mm)	Voltage (volts)	Amperage	Gas
3/32 (2.4)	28-30	275-350	Lincolnweld® P2007
1/8 (3.2)	29-32	350-450	

<sup>(1)</sup>Typical all weld metal. <sup>(2)</sup>See test results disclaimer

IMPORTANT: SPECIAL VENTILATION AND/OR EXHAUST REQUIRED

Fumes from the normal use of some welding products can contain significant quantities of components - such as chromium and manganese - which can lower the 5.0 mg/m<sup>3</sup> maximum exposure guideline for general welding fume.

BEFORE USE, READ AND UNDERSTAND THE SAFETY DATA SHEET (SDS) FOR THIS PRODUCT AND SPECIFIC INFORMATION PRINTED ON THE PRODUCT CONTAINER.



# LINCOLNWELD® 308/308LCF

Stainless ▪ AWS ER308/308L

## KEY FEATURES

- Controlled Low Ferrite (Range 3-8)
- Charpy V-Notch test results capable of exceeding 27 J (20 ft•lbf) @ -196°C (-320°F)
- Exceeds 15 mils (0.38 mm) of lateral expansion @ -196°C (-320°F)
- Q2 Lot® - Certificate showing deposit composition, ferrite number, and charpy impact properties tested at -196°C (-320°F)
- Batch Managed Inventory

## RECOMMENDED FLUX

Lincolnweld® P2007

## CONFORMANCES

AWS A5: ER308, ER308L

## TYPICAL APPLICATIONS

- LNG Storage
- Cryogenic Vessels and Piping

## TYPICAL BASE METALS

- 304L stainless steel
- 18/8 steels with service temperatures down to -196°C (-320°F)

## DIAMETERS / PACKAGING

Diameter in (mm)	55 lb (25 kg) Steel Coil
5/64 (2.0)	ED034914
3/32 (2.4)	ED034915
1/8 (3.2)	ED034916

## MECHANICAL PROPERTIES<sup>(1)</sup>

	Yield Strength <sup>(2)</sup> MPa (ksi)	Tensile Strength MPa (ksi)	Elongation %	Charpy V-Notch J (ft•lbf) -196°C (-320°F)	Lateral Expansion mils (mm) -196°C (-320°F)
<b>Typical Results<sup>(3)</sup></b> As-Welded with Lincolnweld P2007	410 (59)	570 (82)	32	48 (36)	17 (0.43)

## WIRE COMPOSITION<sup>(1)</sup> – As Required per AWS A5.9

	%C	%Cr	%Ni	%Mo	%Mn
<b>Requirements</b> AWS ER308/308L	0.03 max	19.5-22.0	9.0-11.0	0.75 max	1.0-2
<b>Typical Results<sup>(3)</sup></b>	0.03	19.9	10.8	0.12	1.8
	%Si	%P	%S	%Cu	FN
<b>Requirements</b> AWS ER308/308L	0.30-0.65	0.03 max	0.03 max	0.75 max	Not required
<b>Typical Results<sup>(3)</sup></b>	0.35	0.02	0.01	0.14	3-8

<sup>(1)</sup>Typical all weld metal <sup>(2)</sup>Measured with 0.2% offset <sup>(3)</sup>See test results disclaimer

IMPORTANT: SPECIAL VENTILATION AND/OR EXHAUST REQUIRED

Fumes from the normal use of some welding products can contain significant quantities of components - such as chromium and manganese - which can lower the 5.0 mg/m<sup>3</sup> maximum exposure guideline for general welding fume.

BEFORE USE, READ AND UNDERSTAND THE SAFETY DATA SHEET (SDS) FOR THIS PRODUCT AND SPECIFIC INFORMATION PRINTED ON THE PRODUCT CONTAINER.

# LINCOLNWELD® 309LMo\_MOD

Stainless ▪ AWS Similar to ER309LMo

## KEY FEATURES

- Similar to 309 with the exception of the addition of 2.0 - 3.0% molybdenum to increase its pitting corrosion resistance in halide-containing environments
- For surfacing of base metals to improve their resistance to corrosion
- Used to achieve a single-layer overlay with a chemical composition similar to that of a 316L stainless steel
- Q2 Lot® - Certificates showing actual wire chemistry available online

## CONFORMANCES

**Similar to**  
**AWS A5.9:** Similar to ER309LMo  
**ISO 14343:2009:** 23 12 2 L

## TYPICAL APPLICATIONS

- Used for the first layer of multilayer overlays with filler metals such as 316L or 317L stainless steel

## RECOMMENDED FLUXES

P2007, P2000

## DIAMETERS / PACKAGING

Diameter in (mm)	55 lb (25 kg) Steel Spool
3/32 (2.4)	ED035171

## WIRE COMPOSITION<sup>(1)</sup> – As Required per AWS A5.9

	%C	%Cr	%Ni	%Mo	%Mn
<b>Requirements</b> AWS ER309LMo	0.03 max	23.0 - 25.0	12.0 - 14.0	2.0 - 3.0	1.0 - 2.5
<b>Typical Results<sup>(2)</sup></b>	0.01	22.3	15.0	2.6	1.40
	%Si	%P	%S	%Cu	FN
<b>Requirements</b> AWS ER309LMo	0.30 - 0.65	0.03 max	0.03 max	0.75 max	Not Required
<b>Typical Results<sup>(2)</sup></b>	0.40	0.02	0.01	0.10	6 - 12

## TYPICAL OPERATING PROCEDURES

Process	Diameter in (mm)	Voltage (volts)	Amperage	Flux
SAW	3/32 (2.4)	28-33	275-350	Lincolnweld® P2007

<sup>(1)</sup>Typical all weld metal. <sup>(2)</sup>See test results disclaimer

IMPORTANT: SPECIAL VENTILATION AND/OR EXHAUST REQUIRED

Fumes from the normal use of some welding products can contain significant quantities of components - such as chromium and manganese - which can lower the 5.0 mg/m<sup>3</sup> maximum exposure guideline for general welding fume.

BEFORE USE, READ AND UNDERSTAND THE SAFETY DATA SHEET (SDS) FOR THIS PRODUCT AND SPECIFIC INFORMATION PRINTED ON THE PRODUCT CONTAINER.

# LINCOLNWELD® 309/309L

Stainless ▪ AWS ER309, ER309L

## KEY FEATURES

- Designed to be used primarily with basic fluxes that recover nearly all of the wire chromium in the deposit
- Q2 Lot® - Certificate showing actual wire composition and calculated ferrite number (FN) available online
- Low carbon content recommended where there is a risk of intergranular corrosion
- Reduced carbon levels (0.03% max) that offers increased resistance to inter-granular corrosion

## RECOMMENDED FLUXES

Lincolnweld® 801, 802, 880, 880M, 882, P2000, P2007, ST-100

## CONFORMANCES

<b>AWS A5:</b>	ER309. ER309L
<b>ABS:</b>	ER309. ER309L
<b>CWB/CSA:</b>	ER309. ER309L
<b>ISO:</b>	S5309L

## TYPICAL APPLICATIONS

- ASTM A743, A744 Types CF-8 and CF-3 and ASTM A240 Type 309S
- For joining carbon or mild alloy steel to austenitic stainless steels
- Can also be used on "18-8" steels, since it overmatches the corrosion resistance, if the weldment will not be exposed to temperatures of 538° C to 927° C (1000° F to 1700° F)
- Ideal for joining stainless steels to themselves or to carbon or low alloy steels, and can be used at temperatures up to 700° F (371° C)

## DIAMETERS / PACKAGING

Diameter in (mm)	55 lb (25 kg) Steel Spool	500 lb (227 kg) Speed Feed® Drum
5/64 (2.0)	ED033151	
3/32 (2.4)	ED035168	ED036448
1/8 (3.2)	ED035169	ED036449
5/32 (4.0)	ED035170	ED036450*

\*Available upon request

## MECHANICAL PROPERTIES<sup>(1)</sup> – As Required per AWS A5.9

	Yield Strength <sup>(2)</sup> MPa (ksi)	Tensile Strength MPa (ksi)	Elongation %	Ferrite Number
<b>Test Results</b> <sup>(3,5)</sup> - As-Welded	400 (58)	575 (83)	35	8

<sup>(1)</sup>Typical all weld metal. <sup>(2)</sup>Measured with 0.2% offset. <sup>(3)</sup>See test results disclaimer <sup>(4)</sup>AWS Requirement for ER309 is 0.08% max. carbon.

<sup>(5)</sup>Results shown correspond with the recommended Lincolnweld® fluxes listed above, but not required per AWS A5.9-12.

**WIRE COMPOSITION<sup>(1)</sup> – As Required per AWS A5.9**

	%C <sup>(4)</sup>	%Cr	%Ni	%Mo	%Mn	%Si
<b>Requirements</b> - AWS ER309, ER309L	0.03 max	23.0 - 25.0	12.0 - 14.0	0.75 max	1.0 - 2.5	0.30 - 0.65
<b>Typical Results<sup>(3)</sup></b>						
Wire Composition	0.02	23.9	13.0	0.15	1.8	0.50
All Weld Metal Composition <sup>(5)</sup>	0.03	23.1 - 23.6	13.0	0.15	1.5 - 2.0	0.50 - 0.80

**TYPICAL OPERATING PROCEDURES**

Diameter - in (mm)	Wire Feed Speed - in/min (m/min)	Voltage (volts)	Current (amps)
5/64 (2.0)	80-240 (2.0-6.1)	24-30	190-500
3/32 (2.4)	60-210 (1.5-5.3)	26-32	195-575
1/8 (3.2)	35-110 (0.9-2.8)	28-34	200-700
5/32 (4.0)	30-75 (0.8-1.9)	30-36	320-775

<sup>(1)</sup>Typical all weld metal. <sup>(2)</sup>Measured with 0.2% offset. <sup>(3)</sup>See test results disclaimer <sup>(4)</sup>AWS Requirement for ER309 is 0.08% max. carbon.

<sup>(5)</sup>Results shown correspond with the recommended Lincolnweld® fluxes listed above, but not required per AWS A5.9-12.

**IMPORTANT: SPECIAL VENTILATION AND/OR EXHAUST REQUIRED**

Fumes from the normal use of some welding products can contain significant quantities of components - such as chromium and manganese - which can lower the 5.0 mg/m<sup>3</sup> maximum exposure guideline for general welding fume.

BEFORE USE, READ AND UNDERSTAND THE SAFETY DATA SHEET (SDS) FOR THIS PRODUCT AND SPECIFIC INFORMATION PRINTED ON THE PRODUCT CONTAINER.

# LINCOLNWELD® 310

Stainless ▪ AWS ER310

## KEY FEATURES

- Austenitic stainless for high temperatures and heat resistant applications
- Used for welding stainless steels of similar composition in cast and wrought forms
- The weld deposit is fully austenitic, low heat inputs required to prevent cracking
- Q2 Lot® - Certificates showing actual wire chemistry available online

## CONFORMANCES

AWS A5: ER310

ABS: ER310

## TYPICAL APPLICATIONS

- Head shields
- Furnace parts
- Ducting

## RECOMMENDED FLUXES

P2007, P2000

## DIAMETERS / PACKAGING

Diameter in (mm)	55 lb (25 kg) Steel Spool
1/16 (1.6)	ED035172
3/32 (2.4)	ED035173

## WIRE COMPOSITION<sup>(1)</sup> – As Required per AWS A5.9

	%C	%Cr	%Ni	%Mo	%Mn
<b>Requirements</b> AWS ER310	0.08 - 0.15	25.0 - 28.0	20.0 - 22.5	0.75 max	1.0 - 2.5
<b>Typical Results<sup>(2)</sup></b>	0.11	27.1	21.0		1.90
	%Si	%P	%S	%Cu	FN
<b>Requirements</b> AWS ER310	0.30 - 0.65	0.03 max	0.03 max	0.75 max	Not Required
<b>Typical Results<sup>(2)</sup></b>	0.40	0.01	0.003	0.04	

## TYPICAL OPERATING PROCEDURES

Process	Diameter in (mm)	Voltage (volts)	Amperage	Flux
SAW	1/16 (1.6) 3/32 (2.4)	28-33	275-350	Lincolnweld® P2007

<sup>(1)</sup>Typical all weld metal. <sup>(2)</sup>See test results disclaimer

### IMPORTANT: SPECIAL VENTILATION AND/OR EXHAUST REQUIRED

Fumes from the normal use of some welding products can contain significant quantities of components - such as chromium and manganese - which can lower the 5.0 mg/m<sup>3</sup> maximum exposure guideline for general welding fume.

BEFORE USE, READ AND UNDERSTAND THE SAFETY DATA SHEET (SDS) FOR THIS PRODUCT AND SPECIFIC INFORMATION PRINTED ON THE PRODUCT CONTAINER.

# LINCOLNWELD® 316/316LCF

Stainless ▪ AWS ER316/316L

## KEY FEATURES

- Controlled Low Ferrite (Range 3-5)
- Charpy V-Notch test results capable of exceeding 27 J (20 ft•lbf) @ -196°C (-320°F)
- Exceeds 15 mils (0.38 mm) of lateral expansion @ -196°C (-320°F)
- Q2 Lot® - Certificate showing deposit composition, ferrite number, and charpy impact properties tested at -196C(-320F)
- Batch Managed Inventory

## RECOMMENDED FLUX

Lincolnweld® P2007

## CONFORMANCES

AWS A5: ER316, ER316L

## TYPICAL APPLICATIONS

- LNG Storage
- Cryogenic Vessels and Piping

## TYPICAL BASE METALS

316L stainless steels

## DIAMETERS / PACKAGING

Diameter in (mm)	55 lb (25 kg) Steel Coil
5/64 (2.0)	ED034930
3/32 (2.4)	ED034931
1/8 (3.2)	ED034932

## MECHANICAL PROPERTIES<sup>(1)</sup> – As Required per AWS A5.9

	Yield Strength <sup>(2)</sup> MPa (ksi)	Tensile Strength MPa (ksi)	Elongation %	Charpy V-Notch J (ft•lbf) -196°C (-320°F)	Lateral Expansion mils (mm) -196°C (-320°F)
<b>Typical Results<sup>(3)</sup></b> As-Welded with Lincolnweld P2007	420 (61)	610 (89)	43	53 (39)	20 (0.51)

<sup>(1)</sup>Typical all weld metal <sup>(2)</sup>Measured with 0.2% offset <sup>(3)</sup>See test results disclaimer

IMPORTANT: SPECIAL VENTILATION AND/OR EXHAUST REQUIRED

Fumes from the normal use of some welding products can contain significant quantities of components - such as chromium and manganese - which can lower the 5.0 mg/m<sup>3</sup> maximum exposure guideline for general welding fume.

BEFORE USE, READ AND UNDERSTAND THE SAFETY DATA SHEET (SDS) FOR THIS PRODUCT AND SPECIFIC INFORMATION PRINTED ON THE PRODUCT CONTAINER.

# LINCOLNWELD® 316/316L

Stainless ▪ AWS ER316, ER316L

## KEY FEATURES

- Designed to be used primarily with basic fluxes that recover nearly all of the wire chromium in the deposit
- Q2 Lot® - Certificate showing actual wire composition and calculated ferrite number (FN) available online
- Low carbon content recommended where there is a risk of intergranular corrosion
- The 2-3% molybdenum improves pitting corrosion resistance of the weld deposit
- Low carbon content reduces the possibility of carbide precipitation and intergranular corrosion

## RECOMMENDED FLUXES

Lincolnweld® 801, 802, 880, 880M, 882, P2007, ST-100

## CONFORMANCES

<b>AWS A5:</b>	ER316, ER316L
<b>ABS:</b>	ER316, ER316L
<b>CWB/CSA:</b>	ER316, ER316L
<b>ISO:</b>	SS316L

## TYPICAL APPLICATIONS

- ASTM A743, A744 Types CF-8 and CF-3
- Developed for welding type 316 and 316L stainless steels
- For joining the more common austenitic stainless steel grades referred to as "18-8" steels
- For very good corrosion resistance in acid environments
- Power Generation
- Chemical and Petrochemical Processing

## DIAMETERS / PACKAGING

Diameter in (mm)	55 lb (25 kg) Steel Coil	500 lb (227 kg) Speed Feed® Drum	750 lb (340 kg) Speed Feed® Drum	600 lb (272 kg) Speed Feed® Reel
1/16 (1.6)	ED035180			
5/64 (2.0)	ED035174			
3/32 (2.4)	ED035177	ED036452	ED036603	ED034479
1/8 (3.2)	ED035178	ED036453	ED036605	
5/32 (4.0)	ED035179	ED036454*		

\*Available upon request

## MECHANICAL PROPERTIES<sup>(1)</sup> – As Required per AWS A5.9

	Yield Strength <sup>(2)</sup> MPa (ksi)	Tensile Strength MPa (ksi)	Elongation %	Ferrite Number
<b>Test Results<sup>(3, 5)</sup> - As-Welded</b>	380 (55)	550 (80)	42	9

<sup>(1)</sup>Typical all weld metal. <sup>(2)</sup>Measured with 0.2% offset. <sup>(3)</sup>See test results disclaimer <sup>(4)</sup>AWS Requirement for ER316 is 0.08% max. carbon.

<sup>(5)</sup>Results shown correspond with the recommended Lincolnweld® and Blue Max® fluxes listed above, but not required per AWS A5.9-93.

**WIRE COMPOSITION<sup>(1)</sup> – As Required per AWS A5.9**

	%C <sup>(4)</sup>	%Cr	%Ni	%Mo	%Mn	%Si
<b>Requirements</b> - AWS ER316, ER316L	0.03 max	18.0 - 20.0	11.0 - 14.0	2.0 - 3.0	1.0 - 2.5	0.30 - 0.65
<b>Typical Results<sup>(3)</sup></b>						
As-Welded	0.02	19.0	11.9	2.2	1.8	0.50
All Weld Metal Composition <sup>(5)</sup>	0.02	17.8 - 18.4	11.9	2.2	1.6 - 2.0	0.50 - 0.80

**TYPICAL OPERATING PROCEDURES**

Diameter - in (mm)	Wire Feed Speed - m/min (in/min)	Voltage (volts)	Current (amps)
5/64 (2.0)	2.0-6.1 (80-240)	24-30	190-500
3/32 (2.4)	1.5-5.3 (60-210)	26-32	195-575
1/8 (3.2)	0.9-2.8 (35-110)	28-34	200-700
5/32 (4.0)	0.8-1.9 (30-75)	30-36	320-775

<sup>(1)</sup>Typical all weld metal. <sup>(2)</sup>Measured with 0.2% offset. <sup>(3)</sup>See test results disclaimer <sup>(4)</sup>AWS Requirement for ER316 is 0.08% max. carbon.

<sup>(5)</sup>Results shown correspond with the recommended Lincolnweld® and Blue Max® fluxes listed above, but not required per AWS A5.9-93.

IMPORTANT: SPECIAL VENTILATION AND/OR EXHAUST REQUIRED

Fumes from the normal use of some welding products can contain significant quantities of components - such as chromium and manganese - which can lower the 5.0 mg/m<sup>3</sup> maximum exposure guideline for general welding fume.

BEFORE USE, READ AND UNDERSTAND THE SAFETY DATA SHEET (SDS) FOR THIS PRODUCT AND SPECIFIC INFORMATION PRINTED ON THE PRODUCT CONTAINER.



# LINCOLNWELD® 317/317L

Stainless ▪ AWS ER317L

## KEY FEATURES

- Weld deposit similar to 316L with a high molybdenum content for increased corrosion resistance
- Used for welding alloys with similar composition in high corrosive environments
- Q2 Lot® - Certificates showing actual wire chemistry available online

## CONFORMANCES

AWS A5: ER317, ER317L

## TYPICAL APPLICATIONS

- Chemical Processing Plants
- Condensers
- Petrochemical
- Food Processing

## RECOMMENDED FLUXES

P2007, P2000

## DIAMETERS / PACKAGING

Diameter in (mm)	55 lb (25 kg) Steel Spool
3/32 (2.4)	ED035181
1/8 (3.2)	ED035182

## WIRE COMPOSITION<sup>(1)</sup> – As Required per AWS A5.9

	%C	%Cr	%Ni	%Mo	%Mn
<b>Requirements - AWS ER317L</b>	0.03 max	18.5 - 20.5	13.0 - 15.0	3.0 - 4.0	1.0 - 2.5
<b>Typical Results<sup>(2)</sup></b>	0.01	18.9	13.7	3.5	1.4
	%Si	%P	%S	%Cu	
<b>Requirements - AWS ER317L</b>	0.30 - 0.65	0.03 max	0.03 max	0.75 max	
<b>Typical Results<sup>(2)</sup></b>	0.45	0.01	0.008	0.08	

## TYPICAL OPERATING PROCEDURES

Diameter in (mm)	Voltage (volts)	Amperage	Flux
3/32 (2.4)	28-33	275-350	Lincolnweld® P2007
1/8 (3.2)	29-32	350-450	

<sup>(1)</sup>Typical all weld metal. <sup>(2)</sup>See test results disclaimer

IMPORTANT: SPECIAL VENTILATION AND/OR EXHAUST REQUIRED

Fumes from the normal use of some welding products can contain significant quantities of components - such as chromium and manganese - which can lower the 5.0 mg/m<sup>3</sup> maximum exposure guideline for general welding fume.

BEFORE USE, READ AND UNDERSTAND THE SAFETY DATA SHEET (SDS) FOR THIS PRODUCT AND SPECIFIC INFORMATION PRINTED ON THE PRODUCT CONTAINER.

# LINCOLNWELD® 320LR

Stainless ▪ AWS ER320LR

## KEY FEATURES

- Excellent corrosion resistance in highly acidic environments
- Q2 Lot® - Certificates showing actual wire chemistry available online

## RECOMMENDED FLUXES

P2007, P2000

## CONFORMANCES

AWS A5: ER320LR

## TYPICAL APPLICATIONS

- Tanks
- Process Piping
- Heat Exchangers
- Typically used for welding base metals with similar compositions including alloy 20

## DIAMETERS / PACKAGING

Diameter in (mm)	55 lb (25 kg) Steel Spool
3/32 (2.4)	ED035183

## WIRE COMPOSITION<sup>(1)</sup> – As Required per AWS A5.9

	%C	%Cr	%Ni	%Mo	%Mn
<b>Requirements</b> AWS ER320LR	0.025 max	19.0 - 21.0	32.0 - 36.0	2.0 - 3.0	1.5 - 2.0
<b>Typical Results<sup>(2)</sup></b>	0.003	20.1	33.3	2.4	1.7
	%Si	%P	%S	%Cu	%Nb
<b>Requirements</b> AWS ER320LR	0.15 max	0.015 max	0.02 max	3.0 - 4.0	Required 8 x C / 1.0 max
<b>Typical Results<sup>(2)</sup></b>	0.01	0.010	0.001	3.3	0.22

## TYPICAL OPERATING PROCEDURES

Process	Diameter in (mm)	Voltage (volts)	Amperage	Flux
SAW	3/32 (2.4)	29-32	350-450	Lincolnweld® P2007

<sup>(1)</sup>Typical all weld metal. <sup>(2)</sup>See test results disclaimer

IMPORTANT: SPECIAL VENTILATION AND/OR EXHAUST REQUIRED

Fumes from the normal use of some welding products can contain significant quantities of components - such as chromium and manganese - which can lower the 5.0 mg/m<sup>3</sup> maximum exposure guideline for general welding fume.

BEFORE USE, READ AND UNDERSTAND THE SAFETY DATA SHEET (SDS) FOR THIS PRODUCT AND SPECIFIC INFORMATION PRINTED ON THE PRODUCT CONTAINER.

# LINCOLNWELD® 347

Stainless ▪ AWS ER347

## KEY FEATURES

- The addition of niobium reduces intergranular corrosion in severe operating conditions
- Q2 Lot® - Certificates showing actual wire chemistry available online

## CONFORMANCES

AWS A5: ER347

## TYPICAL APPLICATIONS

- Food Processing
- Pharmaceutical Equipment
- Niobium stabilized stainless steel electrodes used for the welding of types 347 and 321 stainless and stainless clad steels

## RECOMMENDED FLUXES

P2000

## DIAMETERS / PACKAGING

Diameter in (mm)	55 lb (25 kg) Steel Spool	500 lb (227 kg) Speed Feed® Reel
3/32 (2.4)	ED035185	ED035184
1/8 (3.2)	ED035186	

## WIRE COMPOSITION<sup>(1)</sup> – As Required per AWS A5.9

	%C	%Cr	%Ni	%Mo	%Nb + Ta
<b>Requirements</b> AWS ER347	0.08 max	19.0 - 21.5	9.0 - 11.0	0.75 max	10 x C - 1.0
<b>Typical Results<sup>(2)</sup></b>	0.03	19.5	9.3	0.25	0.60
	%Mn	%Si	%P	%S	%Cu
<b>Requirements</b> AWS ER347	1.0 - 2.5	0.30 - 0.65	0.03 max	0.03 max	0.75 max
<b>Typical Results<sup>(2)</sup></b>	1.7	0.45	0.01	0.007	0.10

## TYPICAL OPERATING PROCEDURES

Process	Diameter in (mm)	Voltage (volts)	Amperage	Flux
SAW	3/32 (2.4) 1/8 (3.2)	28-33 29-32	275-350 350-450	Lincolnweld® P2000

<sup>(1)</sup>Typical all weld metal. <sup>(2)</sup>See test results disclaimer

IMPORTANT: SPECIAL VENTILATION AND/OR EXHAUST REQUIRED

Fumes from the normal use of some welding products can contain significant quantities of components - such as chromium and manganese - which can lower the 5.0 mg/m<sup>3</sup> maximum exposure guideline for general welding fume.

BEFORE USE, READ AND UNDERSTAND THE SAFETY DATA SHEET (SDS) FOR THIS PRODUCT AND SPECIFIC INFORMATION PRINTED ON THE PRODUCT CONTAINER.

# LINCOLNWELD® 385

Stainless ▪ AWS ER385

## KEY FEATURES

- Weld metal is fully austenitic and must be done with low heat input using a stringer bead technique
- Q2 Lot® - Certificates showing actual wire chemistry available online

## RECOMMENDED FLUXES

P2000, P2007

## CONFORMANCES

AWS A5: ER385

## TYPICAL APPLICATIONS

- Welding 904L Stainless Steel
- Sulfuric and Phosphoric Acid Storage Vessels

## DIAMETERS / PACKAGING

Diameter in (mm)	55 lb (25 kg) Steel Spool
3/32 (2.4)	ED035187

## WIRE COMPOSITION<sup>(1)</sup> – As Required per AWS A5.9

	%C	%Cr	%Ni	%Mo	%Mn
<b>Requirements</b> AWS ER385	0.025 max	19.5 - 21.5	24.0 - 26.0	4.2 - 5.2	1.0 - 2.5
<b>Typical Results<sup>(2)</sup></b> Lincolnweld® 385	0.010	19.9	25.0	4.2	1.8
	%Si	%P	%S	%Cu	
<b>Requirements</b> AWS ER385	0.50 max	0.02 max	0.03 max	1.2 - 2.0	
<b>Typical Results<sup>(2)</sup></b> Lincolnweld® 385	0.3	0.01	0.001	1.4	

## TYPICAL OPERATING PROCEDURES

Diameter in (mm)	Voltage (volts)	Amperage	Flux
3/32 (2.4)	28-33	275-350	Lincolnweld® P2000

<sup>(1)</sup>Typical all weld metal. <sup>(2)</sup>See test results disclaimer

IMPORTANT: SPECIAL VENTILATION AND/OR EXHAUST REQUIRED

Fumes from the normal use of some welding products can contain significant quantities of components - such as chromium and manganese - which can lower the 5.0 mg/m<sup>3</sup> maximum exposure guideline for general welding fume.

BEFORE USE, READ AND UNDERSTAND THE SAFETY DATA SHEET (SDS) FOR THIS PRODUCT AND SPECIFIC INFORMATION PRINTED ON THE PRODUCT CONTAINER.

# LINCOLNWELD® 410NiMo

Stainless ▪ AWS ER410NiMo

## KEY FEATURES

- Used to overlay mild and low alloy steels
- Preheat and inter-pass temperatures of 300°F (150°C) or greater are recommended during welding
- Post-weld heat treatment should not exceed 1150°F (620°C) as higher temperatures may result in hardening
- Q2 Lot® - Certificates showing actual wire chemistry available online

## RECOMMENDED FLUXES

P2007, P2000

## CONFORMANCES

AWS A5: ER410NiMo

## TYPICAL APPLICATIONS

- Turbines
- Valve Bodies
- High Pressure Piping
- Offshore
- Power Generation
- High Pressure Piping
- Designed to weld materials of similar chemical composition in cast and wrought forms
- CA6NM Material

## DIAMETERS / PACKAGING

Diameter in (mm)	55 lb (25 kg) Steel Spool
1/8 (3.2)	ED035188

## WIRE COMPOSITION<sup>(1)</sup> – As Required per AWS A5.9

	%C	%Cr	%Ni	%Mo	%Mn
<b>Requirements</b> AWS ER410NiMo	0.06 max	11.0 - 12.5	4.0 - 5.0	0.4 - 0.7	0.6 max
<b>Typical Results<sup>(2)</sup></b>	0.02	11.7	4.7	0.5	0.2
	%Si	%P	%S	%Cu	
<b>Requirements</b> AWS ER410NiMo	0.5 max	0.03 max	0.03 max	0.75 max	
<b>Typical Results<sup>(2)</sup></b>	0.2	0.01	0.002	0.06	

## TYPICAL OPERATING PROCEDURES

Diameter in (mm)	Voltage (volts)	Amperage	Flux
1/8 (3.2)	29-32	350-450	Lincolnweld® P2000

<sup>(1)</sup>Typical all weld metal. <sup>(2)</sup>See test results disclaimer

IMPORTANT: SPECIAL VENTILATION AND/OR EXHAUST REQUIRED

Fumes from the normal use of some welding products can contain significant quantities of components - such as chromium and manganese - which can lower the 5.0 mg/m<sup>3</sup> maximum exposure guideline for general welding fume.

BEFORE USE, READ AND UNDERSTAND THE SAFETY DATA SHEET (SDS) FOR THIS PRODUCT AND SPECIFIC INFORMATION PRINTED ON THE PRODUCT CONTAINER.

# LINCOLNWELD® 630

Stainless ▪ AWS ER630

## KEY FEATURES

- Precipitation hardening martensitic stainless steel covered electrode used for welding materials of similar chemical composition such as 17-4 and 17-7
- Can be used in the as welded condition or may be heat treated to obtain higher strength
- Mechanical properties of the alloy are greatly influenced by the heat treatment
- Q2 Lot® - Certificates showing actual wire chemistry available online

## RECOMMENDED FLUXES

P2007, P2000

## CONFORMANCES

AWS A5: ER630

## TYPICAL APPLICATIONS

- Hydraulic Equipment Components
- Impellers
- Pump Shafts
- 17-4 PH Stainless Steel

## DIAMETERS / PACKAGING

Diameter in (mm)	500 lb (227 kg) Speed-Feed® Reel
3/32 (2.4)	ED035189

## WIRE COMPOSITION<sup>(1)</sup> – As Required per AWS A5.9

	%C	%Cr	%Ni	%Mo	%Nb
<b>Requirements</b> AWS ER630	0.05 max	16.00 - 16.75	4.5 - 5.0	0.75 max	0.15 - 0.30
<b>Typical Results<sup>(2)</sup></b> Lincolnweld® 630	0.03	16.5	4.8	0.2	0.22
	%Mn	%Si	%P	%S	%Cu
<b>Requirements</b> AWS ER630	0.25 - 0.75	0.75 max	0.03 max	0.03 max	3.25 - 4.0
<b>Typical Results<sup>(3)</sup></b> Lincolnweld® 630	0.54	0.43	0.02	0.02	3.6

## TYPICAL OPERATING PROCEDURES

Process	Diameter in (mm)	Voltage (volts)	Amperage	Gas Flow	Flux
SAW	3/32 (2.4)	-	-	-	Lincolnweld® P2000

<sup>(1)</sup>Typical all weld metal. <sup>(2)</sup>See test results disclaimer

IMPORTANT: SPECIAL VENTILATION AND/OR EXHAUST REQUIRED

Fumes from the normal use of some welding products can contain significant quantities of components - such as chromium and manganese - which can lower the 5.0 mg/m<sup>3</sup> maximum exposure guideline for general welding fume.

BEFORE USE, READ AND UNDERSTAND THE SAFETY DATA SHEET (SDS) FOR THIS PRODUCT AND SPECIFIC INFORMATION PRINTED ON THE PRODUCT CONTAINER.

# LINCOLNWELD® 2209

Stainless ▪ AWS ER2209

## KEY FEATURES

- The welds offer excellent resistance to stress corrosion, cracking and pitting
- The microstructure of the weld metal consists of austenite and ferrite
- The ferrite content of the weld metal will be lower than the ferrite content of type 2205 base metal
- Q2 Lot® - Certificates showing actual wire chemistry available online

## CONFORMANCES

**AWS A5:** ER2209  
**ABS:** ER2209

## TYPICAL APPLICATIONS

- Offshore
- Oil and Gas
- Chemical
- Petrochemical
- Used to weld duplex stainless steels such as (Type 2205)

## RECOMMENDED FLUXES

P2000

## DIAMETERS / PACKAGING

Diameter in (mm)	55 lb (25 kg) Steel Spool
3/32 (2.4)	ED035154
1/8 (3.2)	ED035155

## WIRE COMPOSITION<sup>(1)</sup> – As Required per AWS A5.9

	%C	%Cr	%Ni	%Mo	%Mn	%Si
<b>Requirements</b> AWS ER2209	0.03 max	21.5 - 23.5	7.5 - 9.5	2.5 - 3.5	0.5 - 2.0	0.90 max
<b>Typical Results<sup>(2)</sup></b>	0.01	22.7	8.5	3.0	1.4	0.4
	%P	%S	%N	%Cu	FN	
<b>Requirements</b> AWS ER2209	0.03 max	0.03 max	0.08 - 0.20	0.75 max	Not Required	
<b>Typical Results<sup>(2)</sup></b>	0.01	0.001	0.15	0.06	30 - 60	

## TYPICAL OPERATING PROCEDURES

Process	Diameter in (mm)	Voltage (volts)	Amperage	Flux
SAW	3/32 (2.4) 1/8 (3.2)	28-33 29-32	275-350 350-450	Lincolnweld® P2000

<sup>(1)</sup>Typical all weld metal. <sup>(2)</sup>See test results disclaimer

IMPORTANT: SPECIAL VENTILATION AND/OR EXHAUST REQUIRED

Fumes from the normal use of some welding products can contain significant quantities of components - such as chromium and manganese - which can lower the 5.0 mg/m<sup>3</sup> maximum exposure guideline for general welding fume.

BEFORE USE, READ AND UNDERSTAND THE SAFETY DATA SHEET (SDS) FOR THIS PRODUCT AND SPECIFIC INFORMATION PRINTED ON THE PRODUCT CONTAINER.

# LINCOLNWELD® 2594

Stainless ▪ AWS ER2594

## KEY FEATURES

- A super-duplex grade electrode that provides matching chemistry and mechanical property characteristics to wrought super-duplex alloys such as 2507 and Zeron 100, as well as to super-duplex casting alloys (ATSM A890)
- The electrode is over-alloyed with nitrogen to provide the optimum ferrite/austenite ratio in the finished weld resulting in high tensile and yield strength and superior resistance to stress corrosion, cracking (SCC) and pitting corrosion
- Q2 Lot® - Certificates showing actual wire chemistry available online

## CONFORMANCES

AWS A5: ER2594

ABS: ER2594

## TYPICAL APPLICATIONS

- Process Pipework
- Pumps and Valves
- Pressure Vessels
- 2507
- Zeron 100

## RECOMMENDED FLUXES

P2000

## DIAMETERS / PACKAGING

Diameter in (mm)	55 lb (25 kg) Steel Spool
3/32 (2.4)	ED035156
1/8 (3.2)	ED035157

## WIRE COMPOSITION<sup>(1)</sup> – As Required per AWS A5.9

	%C	%Cr	%Ni	%Mo	%Mn	%Si
<b>Requirements</b> AWS ER2594	0.03 max	24.0 - 27.0	8.0 - 10.5	2.5 - 4.5	2.5 max	1.0 max
<b>Typical Results<sup>(2)</sup></b>	0.02	24.6	8.6	3.8	0.8	0.3
	%P	%S	%N	%Cu	%W	FN
<b>Requirements</b> AWS ER2594	0.03 max	0.02 max	0.20 - 0.30	1.5 max	1.00 max	Not Required
<b>Typical Results<sup>(2)</sup></b>	0.02	0.01	0.25	0.01	0.01	30 - 60

## TYPICAL OPERATING PROCEDURES

Process	Diameter in (mm)	Voltage (volts)	Amperage	Flux
SAW	3/32 (2.4)	28-33	275-350	Lincolnweld® P2000
	1/8 (3.2)	29-32	350-450	

<sup>(1)</sup>Typical all weld metal. <sup>(2)</sup>See test results disclaimer

IMPORTANT: SPECIAL VENTILATION AND/OR EXHAUST REQUIRED

Fumes from the normal use of some welding products can contain significant quantities of components - such as chromium and manganese - which can lower the 5.0 mg/m<sup>3</sup> maximum exposure guideline for general welding fume.

BEFORE USE, READ AND UNDERSTAND THE SAFETY DATA SHEET (SDS) FOR THIS PRODUCT AND SPECIFIC INFORMATION PRINTED ON THE PRODUCT CONTAINER.



# ER16.8.2

Stainless ▪ AWS ER16-8-2

## KEY FEATURES

- Solid wire developed to weld 3XXH grades of stainless steel
- Designed with 0.04-0.10% carbon to create a creep, oxidation, and corrosion resistant weld deposit
- Engineered with controlled carbon levels and ferrite content for high resistance to thermal embrittlement
- A lean composition and controlled ferrite content provides useful cryogenic toughness down to -196°C (-321°F)

## CONFORMANCES

<b>AWS A5.9</b>	ER16-8-2
<b>BS EN ISO 14343-A</b>	16 8 2
<b>BS EN ISO 14343-B</b>	SS16-8-2

## TYPICAL APPLICATIONS

- Gas & Steam Turbines
- Petrochemical & Chemical Industries
- Power Generation Industry
- Steam Piping
- Catalytic Crackers

## DIAMETERS / PACKAGING

Diameter mm	25 kg (55.1 lb) Coil
2.4	SAER1682-24

## MECHANICAL PROPERTIES<sup>(1)</sup> – As Required per AWS A5.9

	Yield Strength <sup>(2)</sup> MPa (ksi)	Tensile Strength MPa (ksi)	Elongation %	Charpy V-Notch J (ft•lbf) @-196°C (-321°F)
<b>Requirements</b> AWS ER16-8-2	-	-	-	-
<b>Typical Results<sup>(3)</sup></b> As-Welded	360 (52)	630 (91)	29 min	30

## DEPOSIT COMPOSITION<sup>(1)</sup> – As Required per AWS A5.9

	%C	%Mn	%Si	%S	%P
<b>Requirements</b> AWS ER16-8-2	0.04-0.10	1.0-2.0	0.3-0.6	0.02 max	0.03 max
<b>Typical Results<sup>(3)</sup></b>	0.06	1.4	0.4	0.01	0.01
	%Cr	%Ni	%Mo	%Cu	
<b>Requirements</b> AWS ER16-8-2	14.5-16.5	7.5-9.5	1.0-2.0	0.3 max	
<b>Typical Results<sup>(3)</sup></b>	15.5	8.5	1.3	0.1	

## TYPICAL OPERATING PROCEDURES

Diameter in (mm)	Polarity	Amperage	Voltage
3/32 (2.4)	DC+	350A	30V

<sup>(1)</sup> Typical all weld metal <sup>(2)</sup> Measured with 0.2% offset <sup>(3)</sup> See test results disclaimer

IMPORTANT: SPECIAL VENTILATION AND/OR EXHAUST REQUIRED

Fumes from the normal use of some welding products can contain significant quantities of components - such as chromium and manganese - which can lower the 5.0 mg/m<sup>3</sup> maximum exposure guideline for general welding fume.

BEFORE USE, READ AND UNDERSTAND THE SAFETY DATA SHEET (SDS) FOR THIS PRODUCT AND SPECIFIC INFORMATION PRINTED ON THE PRODUCT CONTAINER.

# LINCOLNWELD® P2000™

Stainless & Nickel ▪ ENISO 760 – S A AF 2

## KEY FEATURES

- Neutral basic flux designed for welding stainless steel and nickel alloys
- Produces sound welds with excellent slag removal and bead appearance including Nb bearing electrodes such as 347, 625, 606
- Exhibits superior resistance to moisture pickup
- Nickel overlays applications
- Stainless overlay and joining applications

## CONFORMANCES

AWS ENISO 760 - S A AF 2

## TYPICAL APPLICATIONS

- For submerged arc welding of stainless steel and nickel alloys

## PACKAGING

50 lb (22.7 kg) Plastic Bag ED034290

## DEPOSIT COMPOSITION<sup>(1)</sup>

	%C	%Mn	%Si	%Cr	%Ni	%Mo	%P	%S
<b>Lincolnweld® P2000™<sup>(2)</sup></b>								
With Lincolnweld® 308/308L	0.018	1.24	0.631	19.34	9.86	0.04	0.03	0.007
With Lincolnweld® 309/309L	0.014	1.23	0.569	23.18	13.27	0.11	0.02	0.007
With Lincolnweld® 316/316L	0.014	1.30	0.568	18.25	12.00	2.69	0.015	0.013

<sup>(1)</sup> Typical all weld metal. <sup>(2)</sup> See test results disclaimer NOTE: There are not AWS requirements for submerged arc stainless steel deposits.

<p>IMPORTANT: SPECIAL VENTILATION AND/OR EXHAUST REQUIRED</p> <p>Fumes from the normal use of some welding products can contain significant quantities of components - such as chromium and manganese - which can lower the 5.0 mg/m<sup>3</sup> maximum exposure guideline for general welding fume.</p> <p>BEFORE USE, READ AND UNDERSTAND THE SAFETY DATA SHEET (SDS) FOR THIS PRODUCT AND SPECIFIC INFORMATION PRINTED ON THE PRODUCT CONTAINER.</p>
--

# LINCOLNWELD® P2007™

Stainless & Nickel ▪ ENISO 760 – S A AF 2

## KEY FEATURES

- Neutral basic flux designed for welding stainless steel and nickel alloys
- Produces sound welds with excellent slag removal and bead appearance
- Exhibits superior resistance to moisture pickup
- Nickel overlays applications
- Stainless overlay and joining applications
- 2G girth welds with Ni alloys

## TYPICAL APPLICATIONS

- For submerged arc welding of the 300 and 400 series stainless steels, nickel alloys and similar alloy filler metal

## PACKAGING

50 lb (22.7 kg) Plastic Bag ED033159

## MECHANICAL PROPERTIES<sup>(1)</sup>

	Yield Strength <sup>(2)</sup> MPa (ksi)	Tensile Strength MPa (ksi)	Elongation %	Ferrite Number
<b>Lincolnweld® P2007<sup>(3)</sup></b>				
With Lincolnweld® 308/308L	380 (55)	565 (82)	40	7
With Lincolnweld® 309/309L	400 (58)	570 (83)	36	9
With Lincolnweld® 316/316L	380 (55)	550 (80)	43	9

## DEPOSIT COMPOSITION<sup>(1)</sup>

	%C	%Mn	%Si	%Cr	%Ni	%Mo	%P	%S
<b>Lincolnweld® P2007<sup>(3)</sup></b>								
With Lincolnweld® 308/308L	0.02	1.52	0.63	18.83	9.67	0.13	0.02	0.01
With Lincolnweld® 309/309L	0.03	1.71	0.59	23.58	13.35	0.09	0.02	<0.01
With Lincolnweld® 316/316L	0.02	1.36	0.58	18.04	11.50	2.14	0.02	0.01

<sup>(1)</sup>Typical all weld metal. <sup>(2)</sup>Measured with 0.2% offset. <sup>(3)</sup>See test results disclaimer  
NOTE: There are no AWS requirements for submerged arc stainless steel deposits.

IMPORTANT: SPECIAL VENTILATION AND/OR EXHAUST REQUIRED

Fumes from the normal use of some welding products can contain significant quantities of components - such as chromium and manganese - which can lower the 5.0 mg/m<sup>3</sup> maximum exposure guideline for general welding fume.

BEFORE USE, READ AND UNDERSTAND THE SAFETY DATA SHEET (SDS) FOR THIS PRODUCT AND SPECIFIC INFORMATION PRINTED ON THE PRODUCT CONTAINER.

# LINCOLNWELD® ST-100™

Stainless ▪ ENISO 760 – S A AS 2

## KEY FEATURES

- An alloy flux designed for use with solid stainless steel electrodes to compensate for chromium in the wire that is not recovered in the weld deposit
- Excellent slag removal characteristics
- Good performance on seamer applications

## TYPICAL APPLICATIONS

- General submerged arc welding of common austenitic stainless steels such as 304, 304L, 316, 316L, 309 and 347

## PACKAGING

60 lb (27.2 kg) Plastic Bag      ED031856

## MECHANICAL PROPERTIES<sup>(1)</sup>

	Yield Strength <sup>(2)</sup> MPa (ksi)	Tensile Strength MPa (ksi)	Elongation %	Ferrite Number
<b>Lincolnweld® ST-100<sup>(3)</sup></b>				
With Lincolnweld® 308/308L	405 (59)	600 (87)	38	10
With Lincolnweld® 309/309L	415 (60)	585 (85)	37	14
With Lincolnweld® 316/316L	415 (60)	585 (85)	40	10

## DEPOSIT COMPOSITION<sup>(1)</sup>

	%C	%Mn	%Si	%Cr	%Ni	%Mo
<b>Lincolnweld® ST-100<sup>(3, 4)</sup></b>						
With Lincolnweld® 308/308L Groove Weld	0.01 0.02	1.9 2.1	0.50 0.70	19.6 19.6	9.8 9.7	0.10 0.10
With Lincolnweld® 309/309L Groove Weld	0.02 0.03	2.1 2.3	0.40 0.60	23.8 24.1	13.7 13.6	0.10 0.10
With Lincolnweld® 316/316L Groove Weld	0.02 0.02	1.7 1.7	0.45 0.65	19.0 18.8	11.9 11.8	2.20 2.20

<sup>(1)</sup>Typical all weld metal. <sup>(2)</sup>Measured with 0.2% offset. <sup>(3)</sup>See test results disclaimer <sup>(4)</sup>Results shown are typical wire compositions for the Lincolnweld® subarc wires listed, and typical weld deposit composition for 1 in groove welds on matching plate. NOTE: There are no AWS requirements for submerged arc stainless steel deposits.

IMPORTANT: SPECIAL VENTILATION AND/OR EXHAUST REQUIRED

Fumes from the normal use of some welding products can contain significant quantities of components - such as chromium and manganese - which can lower the 5.0 mg/m<sup>3</sup> maximum exposure guideline for general welding fume.

BEFORE USE, READ AND UNDERSTAND THE SAFETY DATA SHEET (SDS) FOR THIS PRODUCT AND SPECIFIC INFORMATION PRINTED ON THE PRODUCT CONTAINER.

# LINCOLN® ER308/308H

Stainless ▪ AWS ER308, ER308H

## KEY FEATURES

- Provides a high carbon deposit (minimum of .04% carbon) for high temperature applications
- Q2 Lot® - Certificate showing actual wire composition and calculated ferrite number (FN) available online
- High carbon deposit provides creep strength and a high tensile strength at elevated temperatures
- Ink jet printing identification on entire length of electrode

## WELDING POSITIONS

All

## CONFORMANCES

AWS A5: ER308 ER308H

## TYPICAL APPLICATIONS

- Chemical
- Petrochemical industries
- Distillery
- Dairy
- Restaurant Equipment
- Catalytic Crackers
- Pulp and Paper
- Used to weld unstabilized austenitic stainless steels such as 302, 304H and 305

## SHIELDING GAS

100% Argon

## DIAMETERS / PACKAGING

Diameter in (mm)	10 lb (4.5 kg) Tube 30 lb (13.6 kg) Master Carton
1/16 (1.6)	ED035199
3/32 (2.4)	ED035200
1/8 (3.2)	ED035201

## WIRE COMPOSITION<sup>(1)</sup> – As Required per AWS A5.9

	%C	%Cr	%Ni	%Mo	%Mn
<b>Requirements</b> AWS ER308H	0.04 - 0.08	19.5 - 22.0	9.00 - 11.00	0.50 max	1.0 - 2.5
<b>Typical Results<sup>(2)</sup></b>	0.06	19.9	9.7	0.07	1.8
	%Si	%P	%S	%Cu	FN
<b>Requirements</b> AWS ER308H	0.30 - 0.65	0.04 max	0.03 max	0.75 max	Not Required
<b>Typical Results<sup>(2)</sup></b>	0.44	0.02	0.006	0.10	5 - 12

<sup>(1)</sup>Typical wire composition. <sup>(2)</sup>See test results disclaimer

IMPORTANT: SPECIAL VENTILATION AND/OR EXHAUST REQUIRED

Fumes from the normal use of some welding products can contain significant quantities of components - such as chromium and manganese - which can lower the 5.0 mg/m<sup>3</sup> maximum exposure guideline for general welding fume.

BEFORE USE, READ AND UNDERSTAND THE SAFETY DATA SHEET (SDS) FOR THIS PRODUCT AND SPECIFIC INFORMATION PRINTED ON THE PRODUCT CONTAINER.

# LINCOLN® ER308/308L

Stainless ▪ AWS ER308, ER308L

## KEY FEATURES

- Balanced chromium and nickel levels provide enough ferrite in the weld for high resistance to hot cracking
- Dual classification ensures the maximum carbon content is 0.03%
- Q2 Lot® - Certificate showing actual wire composition and calculated ferrite number (FN) available online
- 0.03% carbon content increases resistance to intergranular corrosion
- Ink jet printing identification on entire length of electrode

## WELDING POSITIONS

All

## DIAMETERS / PACKAGING

Diameter in (mm)	1 lb (0.5 kg) Plastic Tube 10 lb (4.5 kg) Master Carton	10 lb (4.5 kg) Plastic Tube 30 lb (13.6 kg) Master Carton	10 lb (4.5 kg) Carton	50 lb (22.7 kg) Carton
1/16 (1.6)	ED025410	ED034439	ED025412	ED026655
3/32 (2.4)	ED025413	ED034440	ED025415	ED026656
1/8 (3.2)	ED025416	ED034441	ED025418	ED026657
5/32 (4.0)		ED036060		

## CONFORMANCES

AWS A5: ER308, ER308L

## TYPICAL APPLICATIONS

- Sheet metal on the corresponding stainless steel base metals
- High pressure piping and tubing

## SHIELDING GAS

100% Argon

## WIRE COMPOSITION – As Required per AWS A5.9

	%C <sup>(2)</sup>	%Cr	%Ni	%Mo	%Mn
<b>Requirements</b> - AWS ER308L	0.03 max	19.5 - 22.0	9.0 - 11.0	0.75 max	1.0 - 2.5
<b>Typical Results</b> <sup>(1)</sup>	0.02	20.2	9.2	0.03	1.6
	%Si	%P	%S	%Cu	Total Others
<b>Requirements</b> - AWS ER308L	0.30 - 0.65	0.03 max	0.03 max	0.75 max	0.50 max
<b>Typical Results</b> <sup>(1)</sup>	0.44	0.02	0.02	0.11	0.03

<sup>(1)</sup>See test results disclaimer <sup>(2)</sup>Requirements for ER308 is 0.08% max. carbon.

IMPORTANT: SPECIAL VENTILATION AND/OR EXHAUST REQUIRED

Fumes from the normal use of some welding products can contain significant quantities of components - such as chromium and manganese - which can lower the 5.0 mg/m<sup>3</sup> maximum exposure guideline for general welding fume.

BEFORE USE, READ AND UNDERSTAND THE SAFETY DATA SHEET (SDS) FOR THIS PRODUCT AND SPECIFIC INFORMATION PRINTED ON THE PRODUCT CONTAINER.

# LINCOLN® ER308/308LCF

Stainless ▪ AWS ER308/308L

## KEY FEATURES

- Controlled Low Ferrite (Range 3-6)
- Charpy V-Notch test results capable of exceeding 27 J (20 ft•lbf) @ -196°C (-320°F)
- Exceeds 15 mils (0.38 mm) of lateral expansion @ -196°C (-320°F)
- Q2 Lot® - Certificates showing actual wire composition, ferrite number, and impact properties tested at -196°C (-320°F) available online
- Batch Managed Inventory
- Ink jet printing identification on entire length of electrode

## WELDING POSITIONS

All

## CONFORMANCES

AWS A5: ER308, ER308L

## TYPICAL APPLICATIONS

- LNG Storage
- Cryogenic Vessels and Piping

## SHIELDING GAS

100% Argon

## TYPICAL BASE METALS

- 304L stainless steel
- 18/8 steels with service temperatures down to -196°C (-320°F)

## DIAMETERS / PACKAGING

Diameter in (mm)	10 lb (4.5 kg) Tubes 30 lb (13.6 kg) Master Carton
1/16 (1.6)	ED034911
3/32 (2.4)	ED034912
1/8 (3.2)	ED034913

## MECHANICAL PROPERTIES<sup>(1)</sup>

	Yield Strength <sup>(2)</sup> MPa (ksi)	Tensile Strength MPa (ksi)	Elongation %	Charpy V-Notch J (ft•lbf) -196°C (-320°F)	Lateral Expansion mils (mm) -196°C (-320°F)
<b>Typical Results<sup>(3)</sup></b> As-Welded with 100% Ar	430 (62)	590 (86)	42	62 (84)	38 (0.97)

## WIRE COMPOSITION<sup>(1)</sup> – As Required per AWS A5.9

	%C	%Cr	%Ni	%Mo	%Mn
<b>Requirements</b> - AWS ER308L	0.03 max	19.5 - 22.0	9.0 - 11.0	0.75 max	1.0 - 2.5
<b>Typical Results<sup>(3)</sup></b>	0.02	20.0	10.9	0.12	1.7
	%Si	%P	%S	%Cu	Total Others
<b>Requirements</b> - AWS ER308L	0.30 - 0.65	0.03 max	0.03 max	0.75 max	Not Required
<b>Typical Results<sup>(3)</sup></b>	0.53	0.02	0.01	0.17	3-6

<sup>(1)</sup>Typical all weld metal <sup>(2)</sup>Measured with 0.2% offset <sup>(3)</sup>See test results disclaimer

<p>IMPORTANT: SPECIAL VENTILATION AND/OR EXHAUST REQUIRED</p> <p>Fumes from the normal use of some welding products can contain significant quantities of components - such as chromium and manganese - which can lower the 5.0 mg/m<sup>3</sup> maximum exposure guideline for general welding fume.</p> <p>BEFORE USE, READ AND UNDERSTAND THE SAFETY DATA SHEET (SDS) FOR THIS PRODUCT AND SPECIFIC INFORMATION PRINTED ON THE PRODUCT CONTAINER.</p>
--

# LINCOLN® ER308Si/308LSi

Stainless ▪ AWS ER308Si, ER308LSi

## KEY FEATURES

- High silicon level for increased puddle fluidity and wetting out at the toes
- Solid rod with lower carbon for welding Cr-Ni steels
- Used to primarily weld equipment made with 304 type stainless steel
- Q2 Lot® Tested - A certificate showing actual wire composition and calculated ferrite number (FN) is available online
- Electrode identification is ink jet printed on the entire length of the electrode

## WELDING POSITIONS

All

## CONFORMANCES

AWS A5: ER308LSi, ER308Si

## TYPICAL APPLICATIONS

- 304 and 304L stainless steels
- Common austenitic stainless steels referred to as 18-8 steels
- ASTM A743, A744 Types CF-8 and CF-3

## SHIELDING GAS

GTAW: 100% Ar

## DIAMETERS / PACKAGING

Diameter in (mm)	10 lb (4.5 kg) Plastic Tube 30 lb (13.6 kg) Master Carton
1/16 (1.6)	ED037061
3/32 (2.4)	ED037062
1/8 (3.2)	ED036562
5/32 (4.0)	ED037063

## WIRE COMPOSITION<sup>(1)</sup> – As Required per AWS A5.9/A5.9M: 2017

	%C	%Cr	%Ni	%Mo	%Mn	%Si	%P	%S	%Cu	Total Others
<b>Requirements - AWS ER308LSi</b>	0.03 max	19.5-22.0	9.0-11.0	0.75 max	1.0-2.5	0.65-1.00	0.03 max	0.03 max	0.75 max	Info Only
<b>Typical Results<sup>(1)</sup></b>	0.03	20.0	9.6	0.05	2.0	0.82	0.02	0.02	0.06	0.06
<b>Requirements - AWS ER308Si</b>	0.08 max	19.5-22.0	9.0-11.0	0.75 max	1.0-2.5	0.65-1.00	0.03 max	0.03 max	0.75 max	Info Only
<b>Typical Results<sup>(1)</sup></b>	0.03	20.0	9.6	0.05	2.0	0.82	0.02	0.02	0.06	0.06

## FERRITE NUMBER (FN)

	FN - WRC1992 C
<b>Requirements - AWS ER308LSi</b>	Info. Only
<b>Test Results<sup>(1)</sup></b>	10
<b>Requirements - AWS ER308Si</b>	Info. Only
<b>Test Results<sup>(1)</sup></b>	10

<sup>(1)</sup>See test results disclaimer

IMPORTANT: SPECIAL VENTILATION AND/OR EXHAUST REQUIRED

Fumes from the normal use of some welding products can contain significant quantities of components - such as chromium and manganese - which can lower the 5.0 mg/m<sup>3</sup> maximum exposure guideline for general welding fume.

BEFORE USE, READ AND UNDERSTAND THE SAFETY DATA SHEET (SDS) FOR THIS PRODUCT AND SPECIFIC INFORMATION PRINTED ON THE PRODUCT CONTAINER.



# LINCOLN® ER309/309L

Stainless ▪ AWS ER309, ER309L

## KEY FEATURES

- Q2 Lot® - Certificate showing actual wire composition and calculated ferrite number (FN) available online
- 0.03% carbon content increases resistance to intergranular corrosion
- Ink jet printing identification on entire length of electrode

## WELDING POSITIONS

All

## SHIELDING GAS

100% Argon

## CONFORMANCES

<b>AWS A5:</b>	ER309, ER309L
<b>ABS:</b>	ER309, ER309L
<b>CWB/CSA:</b>	ER309, ER309L
<b>ISO:</b>	S5309L

## TYPICAL APPLICATIONS

- Sheet metal on the corresponding stainless steel base metals
- High pressure piping and tubing
- Use for welding dissimilar alloys in wrought or cast form
- Occasionally used for welding "18-8" base metals when severe corrosion conditions exist or dissimilar metals

## DIAMETERS / PACKAGING

Diameter in (mm)	1 lb (0.5 kg) Plastic Tube 10 lb (4.5 kg) Master Carton	10 lb (4.5 kg) Plastic Tube 30 lb (13.6 kg) Master Carton
1/16 (1.6)	ED025419	ED034442
3/32 (2.4)	ED025422	ED034443
1/8 (3.2)	ED025425	ED034444

## WIRE COMPOSITION – As Required per AWS A5.9

	%C <sup>(2)</sup>	%Cr	%Ni	%Mo	%Mn
<b>Requirements - AWS ER309L</b>	0.03 max	23.0 - 25.0	12.0 - 14.0	0.75 max	1.0 - 2.5
<b>Typical Results<sup>(1)</sup></b>	0.02	23.7	13.9	0.04	1.8
	%Si	%P	%S	%Cu	Total Others
<b>Requirements - AWS ER309L</b>	0.30 - 0.65	0.03 max	0.03 max	0.75 max	0.50 max
<b>Typical Results<sup>(1)</sup></b>	0.51	0.02	0.01	0.05	0.06

<sup>(1)</sup>See test results disclaimer <sup>(2)</sup>Requirements for ER309 is 0.12% max. carbon.

IMPORTANT: SPECIAL VENTILATION AND/OR EXHAUST REQUIRED

Fumes from the normal use of some welding products can contain significant quantities of components - such as chromium and manganese - which can lower the 5.0 mg/m<sup>3</sup> maximum exposure guideline for general welding fume.

BEFORE USE, READ AND UNDERSTAND THE SAFETY DATA SHEET (SDS) FOR THIS PRODUCT AND SPECIFIC INFORMATION PRINTED ON THE PRODUCT CONTAINER.

# LINCOLN® ER309Si/309LSi

Stainless ▪ AWS ER309Si, ER309LSi

ER309LSi, ER309Si

## KEY FEATURES

- High silicon level for increased puddle fluidity and wetting out at the toes
- Excellent weld contour minimizes the need for grinding
- Solid rod for welding stainless steel to carbon steel
- Q2 Lot® Tested - A certificate showing actual wire composition and calculated ferrite number (FN) is available online
- Electrode identification is ink jet printed on the entire length of the electrode

## WELDING POSITIONS

All

## CONFORMANCES

AWS A5: ER309LSi, ER309Si

ISO: SS309LSi, SS309Si

## TYPICAL APPLICATIONS

- Designed for joining stainless to mild or low alloy steel

## SHIELDING GAS

GTAW: 100% Ar

## DIAMETERS / PACKAGING

Diameter in (mm)	10 lb (4.5 kg) Plastic Tube 30 lb (13.6 kg) Master Carton
3/32 (2.4)	ED037113
1/8 (3.2)	ED037114
5/32 (4.0)	ED037115

## WIRE COMPOSITION<sup>(1)</sup> – As Required per AWS A5.9/A5.9M

	%C	%Cr	%Ni	%Mo	%Mn	%Si	%P	%S	%Cu	Total Others
<b>Requirements - AWS ER309LSi</b>	0.03 max	23.0-25.0	12.0-14.0	0.75 max	1.0-2.5	0.65-1.00	0.03 max	0.03 max	0.75 max	Info Only
<b>Typical Results<sup>(1)</sup></b>	0.01	23.4	13.8	0.03	1.9	0.78	0.02	0.01	0.04	0.05
<b>Requirements - AWS ER309Si</b>	0.12 max	23.0-25.0	12.0-14.0	0.75 max	1.0-2.5	0.65-1.00	0.03 max	0.03 max	0.75 max	Info Only
<b>Typical Results<sup>(1)</sup></b>	0.01	23.4	13.8	0.03	1.9	0.78	0.02	0.01	0.04	0.05

## FERRITE NUMBER (FN)

	FN - WRC1992 C
<b>Requirements - AWS ER309LSi</b>	Info. Only
<b>Test Results<sup>(1)</sup></b>	11
<b>Requirements - AWS ER309Si</b>	Info. Only
<b>Test Results<sup>(1)</sup></b>	10

<sup>(1)</sup>See test results disclaimer.

IMPORTANT: SPECIAL VENTILATION AND/OR EXHAUST REQUIRED

Fumes from the normal use of some welding products can contain significant quantities of components - such as chromium and manganese - which can lower the 5.0 mg/m<sup>3</sup> maximum exposure guideline for general welding fume.

BEFORE USE, READ AND UNDERSTAND THE SAFETY DATA SHEET (SDS) FOR THIS PRODUCT AND SPECIFIC INFORMATION PRINTED ON THE PRODUCT CONTAINER.

# LINCOLN® ER310

Stainless ▪ AWS ER310

## KEY FEATURES

- The weld deposit is fully austenitic, and as such, calls for minimal heat input during welding
- Q2 Lot® - Certificate showing actual wire composition
- Ink jet printing identification on entire length of electrode

## WELDING POSITIONS

All

## CONFORMANCES

**AWS A5:** ER310

**ABS:** ER310

## TYPICAL APPLICATIONS

- Head shields
- Furnace parts
- Ducting
- Used for welding stainless steels of similar composition in cast and wrought forms

## SHIELDING GAS

100% Argon

## DIAMETERS / PACKAGING

Diameter in (mm)	10 lb (4.5 kg) Tube 30 lb (13.6 kg) Master Carton
1/16 (1.6)	ED035214
3/32 (2.4)	ED035215
1/8 (3.2)	ED035216

## WIRE COMPOSITION<sup>(1)</sup> – As Required per AWS A5.9

	%C	%Cr	%Ni	%Mo	%Mn
<b>Requirements</b> AWS ER310	0.08 - 0.15	25.0 - 28.0	20.0 - 22.5	0.75 max	1.0 - 2.5
<b>Typical Results<sup>(2)</sup></b>	0.11	27.1	21.0		1.90
	%Si	%P	%S	%Cu	FN
<b>Requirements</b> AWS ER310	0.30 - 0.65	0.03 max	0.03 max	0.75 max	Not Required
<b>Typical Results<sup>(2)</sup></b>	0.40	0.01	0.003	0.04	

<sup>(1)</sup>Typical wire composition. <sup>(2)</sup>See test results disclaimer

IMPORTANT: SPECIAL VENTILATION AND/OR EXHAUST REQUIRED

Fumes from the normal use of some welding products can contain significant quantities of components - such as chromium and manganese - which can lower the 5.0 mg/m<sup>3</sup> maximum exposure guideline for general welding fume.

BEFORE USE, READ AND UNDERSTAND THE SAFETY DATA SHEET (SDS) FOR THIS PRODUCT AND SPECIFIC INFORMATION PRINTED ON THE PRODUCT CONTAINER.

# LINCOLN® ER312

Stainless ▪ AWS ER312

## KEY FEATURES

- Weld deposit work-hardens, providing good wear resistance and high tensile strength
- Applications should be limited to 800°F (420°C)
- Q2 Lot® - Certificate showing actual wire composition and calculated ferrite number (FN) available online
- Ink jet printing identification on entire length of electrode

## WELDING POSITIONS

All

## CONFORMANCES

AWS A5: ER312

CWB/CSA: ER312

## TYPICAL APPLICATIONS

- Tool steels
- Hard to weld steels
- Cast and wrought alloys
- Dissimilar metals
- Used to weld cast and wrought alloys of similar compositions
- Can be used for joining hard to weld materials and dissimilar metals

## SHIELDING GAS

100% Argon

## DIAMETERS / PACKAGING

Diameter in (mm)	10 lb (4.5 kg) Tube 30 lb (13.6 kg) Master Carton
1/16 (1.6)	ED035217
3/32 (2.4)	ED035218
1/8 (3.2)	ED035219

## WIRE COMPOSITION<sup>(1)</sup> – As Required per AWS A5.9

	%C	%Cr	%Ni	%Mo	%Mn
<b>Requirements</b> AWS ER312	0.15 max	28.0 - 32.0	8.0 - 10.5	0.75 max	1.0 - 2.5
<b>Typical Results<sup>(2)</sup></b>	0.11	29.6	8.9		1.6
	%Si	%P	%S	%Cu	FN
<b>Requirements</b> AWS ER312	0.30 - 0.65	0.03 max	0.03 max	0.75 max	Not Required
<b>Typical Results<sup>(2)</sup></b>	0.44	0.02	0.01	0.10	50 - 80

<sup>(1)</sup>Typical wire composition. <sup>(2)</sup>See test results disclaimer

IMPORTANT: SPECIAL VENTILATION AND/OR EXHAUST REQUIRED

Fumes from the normal use of some welding products can contain significant quantities of components - such as chromium and manganese - which can lower the 5.0 mg/m<sup>3</sup> maximum exposure guideline for general welding fume.

BEFORE USE, READ AND UNDERSTAND THE SAFETY DATA SHEET (SDS) FOR THIS PRODUCT AND SPECIFIC INFORMATION PRINTED ON THE PRODUCT CONTAINER.

# LINCOLN® ER316/316L

Stainless ▪ AWS ER316, ER316L

## KEY FEATURES

- The 2-3% molybdenum improves pitting corrosion resistance of the weld deposit
- Molybdenum grade increases corrosion resistance
- Use for high temperature service applications
- Q2 Lot® - Certificate showing actual wire composition and calculated ferrite number (FN) available online
- 0.03% carbon content increases resistance to intergranular corrosion
- Ink jet printing identification on entire length of electrode

## WELDING POSITIONS

All

## CONFORMANCES

<b>AWS A5:</b>	ER316, ER316L
<b>ABS:</b>	ER316, ER316L
<b>CWB/CSA:</b>	ER316, ER316L
<b>ISO:</b>	SS316L

## TYPICAL APPLICATIONS

- Sheet metal on the corresponding stainless steel base metals
- High pressure piping and tubing
- Use for welding similar alloys containing approximately 2% molybdenum

## SHIELDING GAS

100% Argon

## DIAMETERS / PACKAGING

Diameter in (mm)	1 lb (0.5 kg) Plastic Tube 10 lb (4.5 kg) Master Carton	10 lb (4.5 kg) Plastic Tube 30 lb (13.6 kg) Master Carton
1/16 (1.6)	ED025428	ED034445
3/32 (2.4)	ED025421	ED034446
1/8 (3.2)	ED025434	ED034447
5/32 (4.0)		ED036061

## WIRE COMPOSITION – As Required per AWS A5.9

	%C <sup>(2)</sup>	%Cr	%Ni	%Mo	%Mn
<b>Requirements</b> - AWS ER316L	0.03max	18.0 - 20.0	11.0 - 14.0	2.0 - 3.0	1.0 - 2.5
<b>Typical Results</b> <sup>(1)</sup>	0.02	18.7	11.8	2.3	1.7
	%Si	%P	%S	%Cu	Total Others
<b>Requirements</b> - AWS ER316L	0.30 - 0.65	0.03 max	0.03 max	0.75 max	0.50 max
<b>Typical Results</b> <sup>(1)</sup>	0.52	0.02	0.01	0.10	0.30

<sup>(1)</sup> See test results disclaimer <sup>(2)</sup> Requirements for ER316 is 0.08% max. carbon.

IMPORTANT: SPECIAL VENTILATION AND/OR EXHAUST REQUIRED

Fumes from the normal use of some welding products can contain significant quantities of components - such as chromium and manganese - which can lower the 5.0 mg/m<sup>3</sup> maximum exposure guideline for general welding fume.

BEFORE USE, READ AND UNDERSTAND THE SAFETY DATA SHEET (SDS) FOR THIS PRODUCT AND SPECIFIC INFORMATION PRINTED ON THE PRODUCT CONTAINER.

# LINCOLN® ER316/316LCF

Stainless ▪ AWS ER316/ER316L

## KEY FEATURES

- Controlled Low Ferrite (Range 3-6)
- Charpy V-Notch test results capable of exceeding 27 J (20 ft•lbf) @ -196°C (-320°F)
- Exceeds 15 mils (0.38 mm) of lateral expansion @ -196°C (-320°F)
- Q2 Lot® - Certificates showing actual wire composition, ferrite number, and impact properties tested at -196°C (-320°F) available online
- Batch Managed Inventory
- Ink jet printing identification on entire length of electrode

## WELDING POSITIONS

All

## CONFORMANCES

AWS A5: ER316, ER316L

## TYPICAL APPLICATIONS

- LNG Storage
- Cryogenic Vessels and Piping

## SHIELDING GAS

100% Argon

## TYPICAL BASE METALS

316L stainless steels

## DIAMETERS / PACKAGING

Diameter in (mm)	10 lb (4.5 kg) Tube 30 lb (13.6 kg) Master Carton
1/16 (1.6)	ED034927
3/32 (2.4)	ED034928
1/8 (3.2)	ED034929

## MECHANICAL PROPERTIES<sup>(1)</sup> – As Required per AWS A5.9

	Yield Strength <sup>(2)</sup> MPa (ksi)	Tensile Strength MPa (ksi)	Elongation %	Charpy V-Notch J (ft•lbf) -196°C (-320°F)	Lateral Expansion mils (mm) -196°C (-320°F)
<b>Typical Results<sup>(3)</sup></b> As-Welded with 100% Ar	430 (63)	570 (83)	42	70 (95)	42 (1.1)

## WIRE COMPOSITION<sup>(1)</sup> – As Required per AWS A5.9

	%C	%Cr	%Ni	%Mo	%Mn
<b>Requirements - AWS ER316L</b>	0.03 max	18.0 - 20.0	11.0 - 14.0	2.0 - 3.0	1.0 - 2.5
<b>Typical Results<sup>(3)</sup></b>	0.02	18.5	12.3	2.6	1.7
	%Si	%P	%S	%Cu	Total Others
<b>Requirements - AWS ER316L</b>	0.30 - 0.65	0.03 max	0.03 max	0.75 max	0.50 max
<b>Typical Results<sup>(3)</sup></b>	0.40	0.02	0.01	0.17	0.30

<sup>(1)</sup> Typical all weld metal <sup>(2)</sup> Measured with 0.2% offset <sup>(3)</sup> See test results disclaimer

IMPORTANT: SPECIAL VENTILATION AND/OR EXHAUST REQUIRED

Fumes from the normal use of some welding products can contain significant quantities of components - such as chromium and manganese - which can lower the 5.0 mg/m<sup>3</sup> maximum exposure guideline for general welding fume.

BEFORE USE, READ AND UNDERSTAND THE SAFETY DATA SHEET (SDS) FOR THIS PRODUCT AND SPECIFIC INFORMATION PRINTED ON THE PRODUCT CONTAINER.

# LINCOLN® ER316Si/316LSi

Stainless ▪ AWS ER316Si, ER316LSi

## KEY FEATURES

- High silicon level for increased puddle fluidity and wetting out at the toes
- Molybdenum grade for increased corrosion resistance
- Solid rod with low carbon for welding stainless CrNiMo-steels
- Q2 Lot® Tested - A certificate showing actual wire composition and calculated ferrite number (FN) is available online
- Electrode identification is ink jet printed on the entire length of the electrode

## WELDING POSITIONS

All

## CONFORMANCES

AWS A5: ER316LSi, ER316Si

## TYPICAL APPLICATIONS

- Molybdenum bearing austenitic stainless steels
- Type 316 and 316L

## SHIELDING GAS

GTAW: 100% Ar

## DIAMETERS / PACKAGING

Diameter in (mm)	10 lb (4.5 kg) Plastic Tube 30 lb (13.6 kg) Master Carton
1/16 (1.6)	ED037064
3/32 (2.4)	ED037066
1/8 (3.2)	ED037065
5/32 (4.0)	ED037067

## WIRE COMPOSITION – As Required per AWS A5.9/A5.9M

	%C	%Cr	%Ni	%Mo	%Mn	%Si	%P	%S	%Cu	Total Others
<b>Requirements - AWS ER316LSi</b>	0.03 max	18.0-20.0	11.0-14.0	2.0-3.0	1.0-2.5	0.65-1.00	0.03 max	0.03 max	0.75 max	Info Only
<b>Typical Results<sup>(1)</sup></b>	0.01	18.3	11.3	2.3	1.7	0.87	0.02	0.02	0.07	0.07
<b>Requirements - AWS ER316Si</b>	0.12 max	18.0-20.0	11.0-14.0	2.0-3.0	1.0-2.5	0.65-1.00	0.03 max	0.03 max	0.75 max	Info Only
<b>Typical Results<sup>(1)</sup></b>	0.01	18.3	11.3	2.3	1.7	0.87	0.02	0.02	0.07	0.07

<sup>(1)</sup>See test results disclaimer

**FERRITE NUMBER (FN)**

	FN - WRC1992 C
<b>Requirements -</b> AWS ER316LSi	Info. Only
<b>Test Results<sup>(1)</sup></b>	7
<b>Requirements -</b> AWS ER316Si	Info. Only
<b>Test Results<sup>(1)</sup></b>	7

<sup>(1)</sup>See test results disclaimer

IMPORTANT: SPECIAL VENTILATION AND/OR EXHAUST REQUIRED

Fumes from the normal use of some welding products can contain significant quantities of components - such as chromium and manganese - which can lower the 5.0 mg/m<sup>3</sup> maximum exposure guideline for general welding fume.

BEFORE USE, READ AND UNDERSTAND THE SAFETY DATA SHEET (SDS) FOR THIS PRODUCT AND SPECIFIC INFORMATION PRINTED ON THE PRODUCT CONTAINER.



# LINCOLN® ER317/317L

Stainless ▪ AWS ER317, ER317L

## KEY FEATURES

- Weld deposit similar to 316L with a high molybdenum content for increased corrosion resistance
- Q2 Lot® - Certificate showing actual wire composition and calculated ferrite number (FN) available online
- Ink jet printing identification on entire length of electrode

## WELDING POSITIONS

All

## CONFORMANCES

AWS A5: ER317, ER317L

## TYPICAL APPLICATIONS

- FGP
- Chemical Processing Plants
- Condensers
- Petrochemical
- Used for welding alloys with similar composition in high corrosive environments

## SHIELDING GAS

100% Argon

## DIAMETERS / PACKAGING

Diameter in (mm)	10 lb (4.5 kg) Tube 30 lb (13.6 kg) Master Carton
1/16 (1.6)	ED035227
3/32 (2.4)	ED035228
1/8 (3.2)	ED035229
5/32 (4.0)	ED035230

## WIRE COMPOSITION<sup>(1)</sup> – As Required per AWS A5.9

	%C	%Cr	%Ni	%Mo	%Mn
<b>Requirements</b> AWS ER317/317L	0.03 max	18.5 - 20.5	13.0 - 15.0	3.0 - 4.0	1.0 - 2.5
<b>Typical Results<sup>(2)</sup></b>	0.01	18.9	13.7	3.5	1.4
	%Si	%P	%S	%Cu	
<b>Requirements</b> AWS ER317/317L	0.30 - 0.65	0.03 max	0.03 max	0.75 max	
<b>Typical Results<sup>(2)</sup></b>	0.45	0.01	0.008	0.08	

<sup>(1)</sup>Typical wire composition. <sup>(2)</sup>See test results disclaimer

IMPORTANT: SPECIAL VENTILATION AND/OR EXHAUST REQUIRED

Fumes from the normal use of some welding products can contain significant quantities of components - such as chromium and manganese - which can lower the 5.0 mg/m<sup>3</sup> maximum exposure guideline for general welding fume.

BEFORE USE, READ AND UNDERSTAND THE SAFETY DATA SHEET (SDS) FOR THIS PRODUCT AND SPECIFIC INFORMATION PRINTED ON THE PRODUCT CONTAINER.

# LINCOLN® ER320LR

Stainless ▪ AWS ER320LR

## KEY FEATURES

- Excellent corrosion resistance in highly acidic environments
- Q2 Lot® - Certificate showing actual wire composition
- Ink jet printing identification on entire length of electrode

## WELDING POSITIONS

All

## CONFORMANCES

AWS A5: ER320LR

## TYPICAL APPLICATIONS

- Tanks
- Process Piping
- Heat Exchangers
- Typically used for welding base metals with similar compositions including alloy 20

## SHIELDING GAS

100% Argon

## DIAMETERS / PACKAGING

Diameter in (mm)	10 lb (4.5 kg) Tube 30 lb (13.6 kg) Master Carton
1/16 (1.6)	ED035231
3/32 (2.4)	ED035232
1/8 (3.2)	ED035233

## WIRE COMPOSITION<sup>(1)</sup> – As Required per AWS A5.9

	%C	%Cr	%Ni	%Mo	%Mn
<b>Requirements</b> AWS ER320LR	0.025 max	19.0 - 21.0	32.0 - 36.0	2.0 - 3.0	1.5 - 2.0
<b>Typical Results<sup>(3)</sup></b>	0.003	20.1	33.3	2.4	1.7
	%Si	%P	%S	%Cu	%Nb
<b>Requirements</b> AWS ER320LR	0.15 max	0.015 max	0.02 max	3.0 - 4.0	Required 8 x C / 1.0 max
<b>Typical Results<sup>(2)</sup></b>	0.01	0.010	0.001	3.3	0.22

<sup>(1)</sup>Typical wire composition. <sup>(2)</sup>See test results disclaimer

IMPORTANT: SPECIAL VENTILATION AND/OR EXHAUST REQUIRED

Fumes from the normal use of some welding products can contain significant quantities of components - such as chromium and manganese - which can lower the 5.0 mg/m<sup>3</sup> maximum exposure guideline for general welding fume.

BEFORE USE, READ AND UNDERSTAND THE SAFETY DATA SHEET (SDS) FOR THIS PRODUCT AND SPECIFIC INFORMATION PRINTED ON THE PRODUCT CONTAINER.

# LINCOLN® ER347

Stainless ▪ AWS ER347

## KEY FEATURES

- Niobium stabilized stainless steel electrodes
- The addition of niobium reduces intergranular corrosion in severe operating conditions
- Q2 Lot® - Certificate showing actual wire composition and calculated ferrite number (FN) available online
- Ink jet printing identification on entire length of electrode

## WELDING POSITIONS

All

## CONFORMANCES

AWS A5: ER347

ABS: ER347

## TYPICAL APPLICATIONS

- Food Processing
- Pharmaceutical Equipment
- Used for welding Types 347 and 321 stainless and stainless clad steels

## SHIELDING GAS

100% Argon

## DIAMETERS / PACKAGING

Diameter in (mm)	10 lb (4.5 kg) Tube 30 lb (13.6 kg) Master Carton
1/16 (1.6)	ED035235
3/32 (2.4)	ED035237
1/8 (3.2)	ED035239

## WIRE COMPOSITION<sup>(1)</sup> – As Required per AWS A5.9

	%C	%Cr	%Ni	%Mo	%Nb + Ta
<b>Requirements</b> AWS ER347	0.08 max	19.0 - 21.5	9.0 - 11.0	0.75 max	10 x C - 1.0
<b>Typical Results<sup>(2)</sup></b>	0.03	19.5	9.3	0.25	0.60
	%Mn	%Si	%P	%S	%Cu
<b>Requirements</b> AWS ER347	1.0 - 2.5	0.30 - 0.65	0.03 max	0.03 max	0.75 max
<b>Typical Results<sup>(2)</sup></b>	1.7	0.45	0.01	0.007	0.10

<sup>(1)</sup>Typical wire composition. <sup>(2)</sup>See test results disclaimer

IMPORTANT: SPECIAL VENTILATION AND/OR EXHAUST REQUIRED

Fumes from the normal use of some welding products can contain significant quantities of components - such as chromium and manganese - which can lower the 5.0 mg/m<sup>3</sup> maximum exposure guideline for general welding fume.

BEFORE USE, READ AND UNDERSTAND THE SAFETY DATA SHEET (SDS) FOR THIS PRODUCT AND SPECIFIC INFORMATION PRINTED ON THE PRODUCT CONTAINER.

# LINCOLN® ER385

Stainless ▪ AWS ER385

## KEY FEATURES

- Weld metal is fully austenitic and must be done with low heat input using a stringer bead technique
- Q2 Lot® - Certificate showing actual wire composition and calculated ferrite number (FN) available online
- Ink jet printing identification on entire length of electrode

## WELDING POSITIONS

All

## SHIELDING GAS

100% Argon

## CONFORMANCES

AWS A5: ER385

## TYPICAL APPLICATIONS

- Pipeline segment
- Agitators
- Rotars
- Used in fabrication of equipment and vessels for handling and storage of sulfuric acid and phosphoric acid
- Used for welding materials of similar chemical composition (Type 904L)

## DIAMETERS / PACKAGING

Diameter in (mm)	10 lb (4.5 kg) Tube 30 lb (13.6 kg) Master Carton
1/16 (1.6)	ED035240
3/32 (2.4)	ED035241

## WIRE COMPOSITION<sup>(1)</sup> – As Required per AWS A5.9

	%C	%Cr	%Ni	%Mo	%Mn
<b>Requirements</b> AWS ER385	0.025 max	19.5 - 21.5	24.0 - 26.0	4.2 - 5.2	1.0 - 2.5
<b>Typical Results<sup>(2)</sup></b>	0.010	19.9	25.0	4.2	1.8
	%Si	%P	%S	%Cu	
<b>Requirements</b> AWS ER385	0.50 max	0.02 max	0.03 max	1.2 - 2.0	
<b>Typical Results<sup>(2)</sup></b>	0.3	0.01	0.001	1.4	

<sup>(1)</sup>Typical wire composition. <sup>(2)</sup>See test results disclaimer

IMPORTANT: SPECIAL VENTILATION AND/OR EXHAUST REQUIRED

Fumes from the normal use of some welding products can contain significant quantities of components - such as chromium and manganese - which can lower the 5.0 mg/m<sup>3</sup> maximum exposure guideline for general welding fume.

BEFORE USE, READ AND UNDERSTAND THE SAFETY DATA SHEET (SDS) FOR THIS PRODUCT AND SPECIFIC INFORMATION PRINTED ON THE PRODUCT CONTAINER.

# LINCOLN® ER409Nb

Stainless ▪ AWS ER409Nb

## KEY FEATURES

- A ferritic stainless steel welding wire
- The addition of niobium improves corrosion resistance and promotes a ferritic micro-structure
- For the best results, welding must be done in a low heat input procedure and is not recommended for multi-pass applications
- Q2 Lot® - Certificate showing actual wire composition and calculated ferrite number (FN) available online
- Ink jet printing identification on entire length of electrode

## WELDING POSITIONS

All

## CONFORMANCES

AWS A5.9: ER409Nb

ASME SFA-5.9: ER409Nb

## TYPICAL APPLICATIONS

- Automotive exhausts
- Used to weld Type 409 and 409Ti base materials

## SHIELDING GAS

100% Argon

## DIAMETERS / PACKAGING

Diameter in (mm)	10 lb (4.5 kg) Tube 30 lb (13.6 kg) Master Carton
1/16 (1.6)	ED035242
3/32 (2.4)	ED035243

## WIRE COMPOSITION<sup>(1)</sup> – As Required per AWS A5.9

	%C	%Cr	%Ni	%Mo	%Nb
<b>Requirements</b> AWS ER409Nb	0.08 max	10.5 - 13.5	0.6 max.	0.50 max	0.075 max
<b>Typical Results<sup>(2)</sup></b>	0.04	11.5	0.4	0.03	0.50
	%Mn	%Si	%P	%S	%Cu
<b>Requirements</b> AWS ER409Nb	0.8 max	1.0 max	0.04 max	0.03 max	0.75 max
<b>Typical Results<sup>(2)</sup></b>	0.62	0.48	0.02	0.02	0.04

<sup>(1)</sup>Typical wire composition. <sup>(2)</sup>See test results disclaimer

IMPORTANT: SPECIAL VENTILATION AND/OR EXHAUST REQUIRED

Fumes from the normal use of some welding products can contain significant quantities of components - such as chromium and manganese - which can lower the 5.0 mg/m<sup>3</sup> maximum exposure guideline for general welding fume.

BEFORE USE, READ AND UNDERSTAND THE SAFETY DATA SHEET (SDS) FOR THIS PRODUCT AND SPECIFIC INFORMATION PRINTED ON THE PRODUCT CONTAINER.

# LINCOLN® ER410

Stainless ▪ AWS ER410

## KEY FEATURES

- Designed to weld stainless steels of similar chemical composition as well as to overlay carbon steels to impart corrosion, erosion and abrasion resistance
- This material, being an air-hardening type, calls for a pre-heat and inter-pass temperature of 400°F (200°C) or greater during welding
- Q2 Lot® - Certificate showing actual wire composition
- Ink jet printing identification on entire length of electrode

## WELDING POSITIONS

All

## CONFORMANCES

AWS A5: ER410

## TYPICAL APPLICATIONS

- Surfacing Steel Mill Rolls
- Furnace and Burner Parts
- Turbine Parts

## SHIELDING GAS

100% Argon

## DIAMETERS / PACKAGING

Diameter in (mm)	10 lb (4.5 kg) Tube 30 lb (13.6 kg) Master Carton
1/16 (1.6)	ED035244
3/32 (2.4)	ED035245
1/8 (3.2)	ED035246

## WIRE COMPOSITION<sup>(1)</sup> – As Required per AWS A5.9

	%C	%Cr	%Ni	%Mo	%Mn
<b>Requirements</b> AWS ER410	0.12 max	11.5 - 13.5	0.6 max	0.75 max	0.6 max
<b>Typical Results<sup>(2)</sup></b>	0.11	12.5	0.1	0.03	0.45
	%Si	%P	%S	%Cu	
<b>Requirements</b> AWS ER410	0.5 max	0.03 max	0.03 max	0.75 max	
<b>Typical Results<sup>(2)</sup></b>	0.39	0.01	0.01	0.14	

<sup>(1)</sup>Typical wire composition. <sup>(2)</sup>See test results disclaimer

IMPORTANT: SPECIAL VENTILATION AND/OR EXHAUST REQUIRED

Fumes from the normal use of some welding products can contain significant quantities of components - such as chromium and manganese - which can lower the 5.0 mg/m<sup>3</sup> maximum exposure guideline for general welding fume.

BEFORE USE, READ AND UNDERSTAND THE SAFETY DATA SHEET (SDS) FOR THIS PRODUCT AND SPECIFIC INFORMATION PRINTED ON THE PRODUCT CONTAINER.

# LINCOLN® ER410NiMo

Stainless ▪ AWS ER410NiMo

## KEY FEATURES

- Used to overlay mild and low alloy steels
- Preheat and inter-pass temperatures of 300°F (150°C) or greater is recommended during welding
- Post-weld heat treatment should not exceed 1150°F (620°C) as higher temperatures may result in hardening
- Q2 Lot® - Certificate showing actual wire composition
- Ink jet printing identification on entire length of electrode

## WELDING POSITIONS

All

## CONFORMANCES

AWS A5: ER410NiMo

## TYPICAL APPLICATIONS

- Turbines
- Valve Bodies
- High Pressure Piping
- Offshore
- Power Generation
- Designed to weld materials of similar chemical composition in cast and wrought forms

## SHIELDING GAS

100% Argon

## DIAMETERS / PACKAGING

Diameter in (mm)	10 lb (4.5 kg) Tube 30 lb (13.6 kg) Master Carton
1/16 (1.6)	ED035247
3/32 (2.4)	ED035248

## WIRE COMPOSITION<sup>(1)</sup> – As Required per AWS A5.9

	%C	%Cr	%Ni	%Mo	%Mn
<b>Requirements</b> AWS ER410NiMo	0.06 max	11.0 - 12.5	4.0 - 5.0	0.4 - 0.7	0.6 max
<b>Typical Results<sup>(2)</sup></b>	0.02	11.7	4.7	0.5	0.2
	%Si	%P	%S	%Cu	
<b>Requirements</b> AWS ER410NiMo	0.5 max	0.03 max	0.03 max	0.75 max	
<b>Typical Results<sup>(2)</sup></b>	0.2	0.01	0.002	0.06	

<sup>(1)</sup>Typical wire composition. <sup>(2)</sup>See test results disclaimer

IMPORTANT: SPECIAL VENTILATION AND/OR EXHAUST REQUIRED

Fumes from the normal use of some welding products can contain significant quantities of components - such as chromium and manganese - which can lower the 5.0 mg/m<sup>3</sup> maximum exposure guideline for general welding fume.

BEFORE USE, READ AND UNDERSTAND THE SAFETY DATA SHEET (SDS) FOR THIS PRODUCT AND SPECIFIC INFORMATION PRINTED ON THE PRODUCT CONTAINER.

# LINCOLN® ER630

Stainless ▪ AWS ER630

## KEY FEATURES

- Precipitation hardening martensitic stainless steel used for welding materials of similar chemical composition such as 17-4 and 17-7 plates
- Can be used in as welded condition or may be heat treated to obtain higher strength
- Mechanical properties of the alloy are greatly influenced by the heat treatment
- Q2 Lot® - Certificate showing actual wire composition and calculated ferrite number (FN) available online
- Ink jet printing identification on entire length of electrode

## WELDING POSITIONS

All

## CONFORMANCES

AWS A5: ER630

## TYPICAL APPLICATIONS

- Hydraulic Equipment Components
- Impellers
- Pump Shafts

## SHIELDING GAS

100% Argon

## DIAMETERS / PACKAGING

Diameter in (mm)	10 lb (4.5 kg) Tube 30 lb (13.6 kg) Master Carton
1/16 (1.6)	ED035250
3/32 (2.4)	ED035252

## WIRE COMPOSITION<sup>(1)</sup> – As Required per AWS A5.9

	%C	%Cr	%Ni	%Mo	%Nb
<b>Requirements</b> AWS ER630	0.05 max	16.00 - 16.75	4.5 - 5.0	0.75 max	0.15 - 0.30
<b>Typical Results<sup>(2)</sup></b>	0.03	16.5	4.8	0.2	0.22
	%Mn	%Si	%P	%S	%Cu
<b>Requirements</b> AWS ER630	0.25 - 0.75	0.75 max	0.03 max	0.03 max	3.25 - 4.0
<b>Typical Results<sup>(2)</sup></b>	0.54	0.43	0.02	0.02	3.6

<sup>(1)</sup>Typical wire composition. <sup>(2)</sup>See test results disclaimer

### IMPORTANT: SPECIAL VENTILATION AND/OR EXHAUST REQUIRED

Fumes from the normal use of some welding products can contain significant quantities of components - such as chromium and manganese - which can lower the 5.0 mg/m<sup>3</sup> maximum exposure guideline for general welding fume.

BEFORE USE, READ AND UNDERSTAND THE SAFETY DATA SHEET (SDS) FOR THIS PRODUCT AND SPECIFIC INFORMATION PRINTED ON THE PRODUCT CONTAINER.



# LINCOLN® ER2209

Stainless ▪ AWS ER2209

## KEY FEATURES

- The welds offer excellent resistance to stress corrosion, cracking and pitting
- The microstructure of the weld metal consists of austenite and ferrite
- The ferrite content of the weld metal will be lower than the ferrite content of type 2205 base metal
- Welding of duplex stainless steels calls for controlled welding parameters to achieve specified mechanical and corrosion resistant properties
- Q2 Lot® - Certificate showing actual wire composition and calculated ferrite number (FN) available online
- Ink jet printing identification on entire length of electrode

## CONFORMANCES

**AWS A5:** ER2209

**ABS:** ER2209

## TYPICAL APPLICATIONS

- Offshore
- Oil and Gas
- Chemical
- Petrochemical
- Used to weld duplex stainless steels such as (Type 2205)

## SHIELDING GAS

100% Argon

## WELDING POSITIONS

All

## DIAMETERS / PACKAGING

Diameter in (mm)	10 lb (4.5 kg) Tube 30 lb (13.6 kg) Master Carton
1/16 (1.6)	ED035191
3/32 (2.4)	ED035192
1/8 (3.2)	ED035193

## WIRE COMPOSITION<sup>(1)</sup> – As Required per AWS A5.9

	%C	%Cr	%Ni	%Mo	%Mn	%Si
<b>Requirements</b> AWS ER2209	0.03 max	21.5 - 23.5	7.5 - 9.5	2.5 - 3.5	0.5 - 2.0	0.90 max
<b>Typical Results<sup>(2)</sup></b>	0.01	22.7	8.5	3.0	1.4	0.4
	%P	%S	%N	%Cu	FN	
<b>Requirements</b> AWS ER2209	0.03 max	0.03 max	0.08 - 0.20	0.75 max	Not Required	
<b>Typical Results<sup>(2)</sup></b>	0.01	0.001	0.15	0.06	30 - 60	

<sup>(1)</sup>Typical wire composition. <sup>(2)</sup>See test results disclaimer

### IMPORTANT: SPECIAL VENTILATION AND/OR EXHAUST REQUIRED

Fumes from the normal use of some welding products can contain significant quantities of components - such as chromium and manganese - which can lower the 5.0 mg/m<sup>3</sup> maximum exposure guideline for general welding fume.

BEFORE USE, READ AND UNDERSTAND THE SAFETY DATA SHEET (SDS) FOR THIS PRODUCT AND SPECIFIC INFORMATION PRINTED ON THE PRODUCT CONTAINER.

# LINCOLN® ER2594

Stainless ▪ AWS ER2594

## KEY FEATURES

- A super-duplex grade electrode that provides matching chemistry and mechanical property characteristics to wrought super-duplex alloys such as 2507 and Zeron 100, as well as to super-duplex casting alloys (ATSM A890)
- The electrode is over-alloyed with nitrogen to provide the optimum ferrite/austenite ratio in the finished weld resulting in high tensile and yield strength and superior resistance to stress corrosion, cracking (SCC) and pitting corrosion
- Q2 Lot® - Certificate showing actual wire composition and calculated ferrite number (FN) available online
- Ink jet printing identification on entire length of electrode

## WELDING POSITIONS

All

## CONFORMANCES

AWS A5: ER2594

ABS: ER2594

## TYPICAL APPLICATIONS

- Process Pipework
- Pumps and Valves
- Pressure Vessels
- Used to weld superduplex stainless steels such as Type 2507 and Zeron 100

## SHIELDING GAS

100% Argon

## DIAMETERS / PACKAGING

Diameter in (mm)	10 lb (4.5 kg) Tube 30 lb (13.6 kg) Master Carton
1/16 (1.6)	ED035194
3/32 (2.4)	ED035195
1/8 (3.2)	ED035196

## WIRE COMPOSITION<sup>(1)</sup> – As Required per AWS A5.9

	%C	%Cr	%Ni	%Mo	%Mn	%Si
<b>Requirements</b> AWS ER2594	0.03 max	24.0 - 27.0	8.0 - 10.5	2.5 - 4.5	2.5 max	1.0 max
<b>Typical Results<sup>(2)</sup></b>	0.02	24.6	8.6	3.8	0.8	0.3
	%P	%S	%N	%Cu	%W	FN
<b>Requirements</b> AWS ER2594	0.03 max	0.02 max	0.20 - 0.30	1.5 max	1.00 max	Not Required
<b>Typical Results<sup>(2)</sup></b>	0.02	0.01	0.25	0.01	0.01	30 - 60

<sup>(1)</sup>Typical wire composition. <sup>(2)</sup>See test results disclaimer

IMPORTANT: SPECIAL VENTILATION AND/OR EXHAUST REQUIRED

Fumes from the normal use of some welding products can contain significant quantities of components - such as chromium and manganese - which can lower the 5.0 mg/m<sup>3</sup> maximum exposure guideline for general welding fume.

BEFORE USE, READ AND UNDERSTAND THE SAFETY DATA SHEET (SDS) FOR THIS PRODUCT AND SPECIFIC INFORMATION PRINTED ON THE PRODUCT CONTAINER.

# ER16.8.2

Stainless ▪ AWS ER16-8-2

## KEY FEATURES

- 16% Chromium, 8% nickel, 2% molybdenum cut length
- Low ferrite weld deposit (1-5)
- Cryogenic toughness properties down to -196°C (-320°F)
- Designed to weld 304H, 316H, 321 and 347H base materials

## WELDING POSITIONS

All

## SHIELDING GAS

100% Argon

## CONFORMANCES

<b>AWS A5.9</b>	ER16-8-2
<b>BS EN ISO 14343-A</b>	16 8 2
<b>BS EN ISO 14343-B</b>	SS16-8-2

## TYPICAL APPLICATIONS

- Furnace parts
- Gas and steam turbine
- Petrochemical
- Chemical process plants
- Power generation industries
- Cryogenic applications
- Catalytic crackers
- Steam Piping

## DIAMETERS / PACKAGING

Diameter in (mm)	5.5 lb (2.5 kg) Tube
3/32 (2.5)	TER1682-24
1/8 (3.2)	TER1682-32

## MECHANICAL PROPERTIES<sup>(1)</sup> – As Required per AWS A5.9

	Yield Strength <sup>(2)</sup> MPa (ksi)	Tensile Strength MPa (ksi)	Elongation %	Charpy V-Notch J (ft·lbf) @-196°C (-321°F)
<b>Requirements</b> AWS ER16-8-2 As-Welded	-	550 (80)	35 min	-
<b>Typical Results<sup>(3)</sup></b> As-Welded	420 (61)	620 (90)	40	30 (22)

## DEPOSIT COMPOSITION<sup>(1)</sup> – As Required per AWS A5.9

	%C	%Mn	%Si	%S	%P
<b>Requirements</b> AWS ER16-8-2	0.10 max	1.0-2.0	0.3-0.6	0.02 max	0.03 max
<b>Typical Results<sup>(3)</sup></b>	0.06	1.4	0.4	0.01	0.01
	%Cr	%Ni	%Mo	%Cu	
<b>Requirements</b> AWS ER16-8-2	14.5-16.5	7.5-9.5	1.0-2.0	0.75 max	
<b>Typical Results<sup>(3)</sup></b>	15.5	8.5	1.3	0.1	

<sup>(1)</sup> Typical wire composition. <sup>(2)</sup> Measured with 0.2% offset. <sup>(3)</sup> See test results disclaimer.

### IMPORTANT: SPECIAL VENTILATION AND/OR EXHAUST REQUIRED

Fumes from the normal use of some welding products can contain significant quantities of components - such as chromium and manganese - which can lower the 5.0 mg/m<sup>3</sup> maximum exposure guideline for general welding fume.

BEFORE USE, READ AND UNDERSTAND THE SAFETY DATA SHEET (SDS) FOR THIS PRODUCT AND SPECIFIC INFORMATION PRINTED ON THE PRODUCT CONTAINER.

# PRIMALLOY™ T-409Ti

Stainless ▪ AWS EC409

## KEY FEATURES

- Minimal spatter and slag
- Great deposition rates
- High travel speed welding on thin material

## WELDING POSITIONS

All Positions

## CONFORMANCES

AWS A5.22: EC409

## TYPICAL APPLICATIONS

- Designed for joining components of automotive exhaust systems, such as catalytic converters
- Single pass welding

## SHIELDING GAS

98% Ar / 2% O<sub>2</sub>,  
40-45 CFH

## DIAMETERS / PACKAGING

Diameter mm (in)	33 lb (15 kg) Plastic Spool	500 lb (227 kg) Bulk Drum
0.045 (1.2)	ED034208	ED034209

## DEPOSIT COMPOSITION<sup>(1)</sup> – As Required per AWS A5.22

	%C	%Cr	%Ni	%Mo	%Mn
<b>Requirements</b> AWS EC409	0.08	10.5-13.5	0.6	0.5	0.8
<b>Typical Results<sup>(2)</sup></b> 98% Argon / 2% O <sub>2</sub>	0.03	11.1	0.02	0.03	0.5
	%Si	%P	%S	%Ti	
<b>Requirements</b> AWS EC409	0.8	0.03	0.03	10xC min 1.5 max	
<b>Typical Results<sup>(2)</sup></b> 98% Argon / 2% O <sub>2</sub>	0.6	0.007	0.008	1.0	

## TYPICAL OPERATING PROCEDURES

Diameter, Polarity, Shielding Gas	CTWD in (mm)	Wire Feed Speed in/min (m/min)	Voltage (Volts)	Approx. Current (Amps)
0.045 (1.2), DC+ 98% Argon / 2% CO <sub>2</sub>	5/8 (15.8)	200 (5.08)	22	200
		250 (6.35)	23	230
		300 (7.62)	25	260
		450 (11.43)	28	335

<sup>(1)</sup>Typical all weld metal. <sup>(2)</sup>See test results disclaimer

IMPORTANT: SPECIAL VENTILATION AND/OR EXHAUST REQUIRED

Fumes from the normal use of some welding products can contain significant quantities of components - such as chromium and manganese - which can lower the 5.0 mg/m<sup>3</sup> maximum exposure guideline for general welding fume.

BEFORE USE, READ AND UNDERSTAND THE SAFETY DATA SHEET (SDS) FOR THIS PRODUCT AND SPECIFIC INFORMATION PRINTED ON THE PRODUCT CONTAINER.

# PRIMALLOY™ T-439Ti

Stainless ▪ AWS EC439

## KEY FEATURES

- Minimal spatter and slag
- Great deposition rates
- High travel speed welding on thin material

## WELDING POSITIONS

All Positions

## CONFORMANCES

AWS A5.22: EC439

## TYPICAL APPLICATIONS

- Designed for joining components of automotive exhaust systems, such as catalytic converters
- Single pass welding

## SHIELDING GAS

98% Ar / 2% O<sub>2</sub>,  
40-45 CFH

## DIAMETERS / PACKAGING

Diameter mm (in)	33 lb (15 kg) Plastic Spool	500 lb (227 kg) Bulk Drum
0.045 (1.2)	ED034293	ED034294

## DEPOSIT COMPOSITION<sup>(1)</sup> – As Required per AWS A5.22

	%C	%Cr	%Ni	%Mo	%Mn
<b>Requirements</b> AWS EC439	0.04	17.0-19.0	0.6	0.5	0.8
<b>Typical Results<sup>(2)</sup></b> 98% Argon / 2% O <sub>2</sub>	0.03	17.5	0.02	0.02	0.47
	%Si	%P	%S	%Ti	
<b>Requirements</b> AWS EC439	0.8	0.03	0.03	10xC min 1.1 max	
<b>Typical Results<sup>(2)</sup></b> 98% Argon / 2% O <sub>2</sub>	0.4	0.01	0.01	0.4	

## TYPICAL OPERATING PROCEDURES

Diameter, Polarity, Shielding Gas	CTWD in (mm)	Wire Feed Speed in/min (m/min)	Voltage (Volts)	Approx. Current (Amps)
0.045 (1.2), DC+ 98% Argon / 2% CO <sub>2</sub>	5/8 (15.8)	200 (5.08)	22	200
		250 (6.35)	23	230
		300 (7.62)	25	260
		450 (11.43)	28	335

<sup>(1)</sup>Typical all weld metal. <sup>(2)</sup>See test results disclaimer

IMPORTANT: SPECIAL VENTILATION AND/OR EXHAUST REQUIRED

Fumes from the normal use of some welding products can contain significant quantities of components - such as chromium and manganese - which can lower the 5.0 mg/m<sup>3</sup> maximum exposure guideline for general welding fume.

BEFORE USE, READ AND UNDERSTAND THE SAFETY DATA SHEET (SDS) FOR THIS PRODUCT AND SPECIFIC INFORMATION PRINTED ON THE PRODUCT CONTAINER.

# BLUE MAX® ORBITAL TIG 308/308L

Stainless ▪ AWS ER308, ER308L

## KEY FEATURES

- Ultra-clean wire for porosity free welds
- Q2 Lot® certificate showing actual wire composition and calculated ferrite number (FN) available online
- Batch Managed Inventory

## WELDING POSITIONS

All

## SHIELDING GAS

100% Argon

## CONFORMANCES

**AWS A5.9** ER308, ER308L  
**ASME SFA-A5.9** ER308, ER308L

## TYPICAL APPLICATIONS

- Process Piping
- Thermal Energy
- Petroleum Processing

## DIAMETERS / PACKAGING

Diameter in (mm)	2 lb (0.9 kg) PWL Spool 8 lb (3.6 kg) Carton	10 lb (4.5 kg) PLW Spool
0.035 (0.9)	ED034153	ED034155

## WIRE COMPOSITION<sup>(1)</sup> – As Required per AWS A5.9

	%C	%Mn	%Si	%S	%P	%Cr
<b>Requirements</b> AWS ER308/308L	0.03 max	1.0-2.5	0.30-0.65	0.03 max	0.03 max	19.5-22.0
<b>Typical Results<sup>(2)</sup></b>	0.02	1.30	0.40	<0.01	0.02	20.30
	%Ni	%Mo	%Cu	%N	FN	
<b>Requirements</b> AWS ER308/308L	9.0-11.0	0.75 max	0.75 max	Not Specified	Not Required	
<b>Typical Results<sup>(2)</sup></b>	10.20	0.16	0.16	0.02	N/A	

<sup>(1)</sup>Typical wire composition. <sup>(2)</sup>See test results disclaimer

IMPORTANT: SPECIAL VENTILATION AND/OR EXHAUST REQUIRED

Fumes from the normal use of some welding products can contain significant quantities of components - such as chromium and manganese - which can lower the 5.0 mg/m<sup>3</sup> maximum exposure guideline for general welding fume.

BEFORE USE, READ AND UNDERSTAND THE SAFETY DATA SHEET (SDS) FOR THIS PRODUCT AND SPECIFIC INFORMATION PRINTED ON THE PRODUCT CONTAINER.

# BLUE MAX® ORBITAL TIG 309/309L

Stainless ▪ AWS ER309, ER309L

## KEY FEATURES

- Ultra-clean wire for porosity free welds
- Q2 Lot® certificate showing actual wire composition and calculated ferrite number (FN) available online
- Batch Managed Inventory

## WELDING POSITIONS

All

## SHIELDING GAS

100% Argon

## CONFORMANCES

**AWS A5.9** ER309, ER309L  
**ASME SFA-A5.9** ER309, ER309L

## TYPICAL APPLICATIONS

- Process Piping
- Thermal Energy
- Petroleum Processing
- Used for joining stainless steels to themselves to low alloy or mild steel

## DIAMETERS / PACKAGING

Diameter in (mm)	2 lb (0.9 kg) PLW Spool 8 lb (3.6 kg) Carton	10 lb (4.5 kg) PLW Spool
0.035 (0.9)	ED034157	ED034159

## WIRE COMPOSITION<sup>(1)</sup> – As Required per AWS A5.9

	%C	%Mn	%Si	%S	%P	%Cr
<b>Requirements</b> AWS ER309/309L	0.03 max	1.0-2.5	0.30-0.65	0.03 max	0.03 max	23.0-25.0
<b>Typical Results<sup>(2)</sup></b>	0.02	1.60	0.36	<0.01	0.02	23.80
	%Ni	%Mo	%Cu	%N	FN	
<b>Requirements</b> AWS ER309/309L	12.0-14.0	0.75 max	0.75 max	Not Specified	Not Required	
<b>Typical Results<sup>(2)</sup></b>	13.30	0.12	0.10	0.08	N/A	

<sup>(1)</sup>Typical wire composition. <sup>(2)</sup>See test results disclaimer

IMPORTANT: SPECIAL VENTILATION AND/OR EXHAUST REQUIRED

Fumes from the normal use of some welding products can contain significant quantities of components - such as chromium and manganese - which can lower the 5.0 mg/m<sup>3</sup> maximum exposure guideline for general welding fume.

BEFORE USE, READ AND UNDERSTAND THE SAFETY DATA SHEET (SDS) FOR THIS PRODUCT AND SPECIFIC INFORMATION PRINTED ON THE PRODUCT CONTAINER.

# BLUE MAX® ORBITAL TIG 316/316L

Stainless ▪ AWS ER316, ER316L

## KEY FEATURES

- Ultra-clean wire for porosity free welds
- Good resistance to pitting, many acids, and general corrosion
- Q2 Lot® certificate showing actual wire composition and calculated ferrite number (FN) available online
- Batch Managed Inventory

## WELDING POSITIONS

All

## SHIELDING GAS

100% Argon

## CONFORMANCES

**AWS A5.9** ER316, ER316L  
**ASME SFA-A5.9** ER316, ER316L

## TYPICAL APPLICATIONS

- Process Piping
- Thermal Energy
- Petroleum Processing

## DIAMETERS / PACKAGING

Diameter in (mm)	2 lb (0.9 kg) PLW Spool 8 lb (3.6 kg) Carton	10 lb (4.5 kg) PLW Spool
0.035 (0.9)	ED034161	ED034163

## WIRE COMPOSITION<sup>(1)</sup> – As Required per AWS A5.9

	%C	%Mn	%Si	%S	%P	%Cr
<b>Requirements</b> AWS ER316/316L	0.03 max	1.0-2.5	0.30-0.65	0.03 max	0.03 max	18.0-20.0
<b>Typical Results<sup>(2)</sup></b>	0.02	1.70	0.37	0.01	0.02	19.60
	%Ni	%Mo	%Cu	%N	FN	
<b>Requirements</b> AWS ER316/316L	11.0-14.0	2.0-3.0	0.75 max	Not Specified	Not Required	
<b>Typical Results<sup>(2)</sup></b>	11.70	2.10	0.04	0.02	N/A	

<sup>(1)</sup>Typical wire composition. <sup>(2)</sup>See test results disclaimer

IMPORTANT: SPECIAL VENTILATION AND/OR EXHAUST REQUIRED

Fumes from the normal use of some welding products can contain significant quantities of components - such as chromium and manganese - which can lower the 5.0 mg/m<sup>3</sup> maximum exposure guideline for general welding fume.

BEFORE USE, READ AND UNDERSTAND THE SAFETY DATA SHEET (SDS) FOR THIS PRODUCT AND SPECIFIC INFORMATION PRINTED ON THE PRODUCT CONTAINER.





CONSUMABLES  
**NICKEL**

*Stick (SMAW) Electrode*

Tech-Rod® 55.....	G-1
Tech-Rod® 99.....	G-2
Tech-Rod® 112.....	G-3
Tech-Rod® 112LFe.....	G-4
Tech-Rod® 117.....	G-5
Tech-Rod® 122.....	G-6
Tech-Rod® 141.....	G-7
Tech-Rod® 182.....	G-8
Tech-Rod® 187.....	G-9
Tech-Rod® 190.....	G-10
Tech-Rod® 276.....	G-11
Tech-Rod® Weld A.....	G-12

*MIG/TIG/SAW Wire*

Techalloy® 55.....	G-13
Techalloy® 99.....	G-14
Techalloy® 208.....	G-15
Techalloy® 276.....	G-16
Techalloy® 413.....	G-17
Techalloy® 418.....	G-18
Techalloy® 606.....	G-19
Techalloy® 617.....	G-20
Techalloy® 622.....	G-21
Techalloy® 625.....	G-22
Techalloy® 686.....	G-23
Techalloy® 718.....	G-24
Techalloy® 825.....	G-25
Techalloy® X.....	G-26

*Flux-Cored (FCAW-G) Wire*

Supercore® 625P.....	G-27
----------------------	------

# TECH-ROD® 55

Nickel ▪ AWS ENiFe-C I

## KEY FEATURES

- The welds are moderately hard and required carbide tipped tools for machining
- A preheat and inter-pass temperature of not less than 350°F (177°C) is required during welding to prevent cracking
- Q2 Lot® - certificates showing actual deposit composition available online

## POLARITY

DC+

## CONFORMANCES

<b>AWS A5.15:</b>	ENiFe-C I
<b>UNS:</b>	W82002
<b>ASME SFA-5.15:</b>	ENiFe-C I

## TYPICAL APPLICATIONS

- Welding of ductile, pliable cast irons
- Dissimilar welds to nickel alloys, carbon steels, and low-alloy steels
- Repair of castings

## DIAMETERS / PACKAGING

Diameter in (mm)	Length in (mm)	8 lb (3.6 kg) Can 24 lb (10.9 kg) Master Carton	10 lb (4.5 kg) Can 30 lb (13.6 kg) Master Can
3/32 (2.4)	12 (305)	EL55093632	
1/8 (3.2)	14 (355)		EL55125634
5/32 (4.0)	14 (355)		EL55156634

## DEPOSIT COMPOSITION<sup>(1)</sup> - As Required per AWS A5.15

	%C	%Mn	%Si	%S	%Fe
<b>Requirements</b> AWS ENiFe-C I	2.0 max	2.5 max	4.0 max	0.03 max	Remainder
<b>Typical Results<sup>(2)</sup></b> Tech-Rod® 55	1.3	0.4	1.0	0.003	—
	%Ni	%Cu	%Al	%Other	
<b>Requirements</b> AWS ENiFe-C I	45.0 - 60.0	2.5 max	1.0 max	1.0 max	
<b>Typical Results<sup>(2)</sup></b> Tech-Rod® 55	50.0	1.0	0.5	—	

## TYPICAL OPERATING PROCEDURES

Diameter in (mm)	Amperage	
	Flat	Vertical & Overhead
3/32 (2.4)	70-85	65-75
1/8 (3.2)	85-110	80-90
5/32 (4.0)	110-140	110-120

<sup>(1)</sup>Typical deposit composition. <sup>(2)</sup>See test results disclaimer  
Safety Data Sheets (SDS) are available on our website at [www.lincolnelectric.com](http://www.lincolnelectric.com)

# TECH-ROD® 99

Nickel ▪ AWS ENi-CI

## KEY FEATURES

- Used for welding of cast irons to other cast irons as well as for joining cast irons to mild steels and stainless steels
- A preheat and inter-pass temperature of not less than 350°F (177°C) is required during welding to prevent cracking
- Q2 Lot® - certificates showing actual deposit composition available online

## POLARITY

DC+

## CONFORMANCES

**AWS A5.15:** ENi-CI  
**UNS:** W82001  
**ASME SFA-5.15:** ENi-C I

## TYPICAL APPLICATIONS

- Generally more machinable than a Tech-Rod® 55 deposit
- Intended to join and repair pliable cast iron

## DIAMETERS / PACKAGING

Diameter in (mm)	Length in (mm)	8 lb (3.6 kg) Can 24 lb (10.9 kg) Master Carton	10 lb (4.5 kg) Can 30 lb (13.6 kg) Master Can
3/32 (2.4)	12 (305)	EL99093632	EL99125634 EL99156634
1/8 (3.2)	14 (355)		
5/32 (4.0)	14 (355)		

## DEPOSIT COMPOSITION<sup>(1)</sup> - As Required per AWS A5.15

	%C	%Mn	%Si	%S	%Fe
<b>Requirements</b> AWS ENi-CI	2.0 max	2.5 max	4.0 max	0.03 max	8.0 max
<b>Typical Results<sup>(2)</sup></b> Tech-Rod® 99	1.5	0.6	0.2	0.002	3.0
	%Ni	%Cu	%Al	%Other	
<b>Requirements</b> AWS ENi-CI	85.0 min	2.5 max	1.0 max	1.0 max	
<b>Typical Results<sup>(2)</sup></b> Tech-Rod® 99	94.0	0.1	0.1	-	

## TYPICAL OPERATING PROCEDURES

Diameter in (mm)	Amperage	
	Flat	Vertical & Overhead
3/32 (2.4)	70-85	65-75
1/8 (3.2)	85-110	80-90
5/32 (4.0)	110-140	110-120

<sup>(1)</sup>Typical deposit composition. <sup>(2)</sup>See test results disclaimer  
 Safety Data Sheets (SDS) are available on our website at [www.lincolnelectric.com](http://www.lincolnelectric.com)

# TECH-ROD® 112

Nickel ▪ AWS ENiCrMo-3

## KEY FEATURES

- A covered electrode which is used to weld nickel-chromium-molybdenum alloys
- These electrodes are used in applications where the temperature ranges from cryogenic up to 1800°F (982°C)
- Q2 Lot® - certificates showing actual deposit composition available online

## POLARITY

DC+

## CONFORMANCES

AWS A5.11: ENiCrMo-3  
 UNS: W86112  
 ASME SFA-5.11: ENiCrMo-3

## TYPICAL APPLICATIONS

- Used extensively in overlay cladding where a similar chemical composition is required on the clad side
- Dissimilar joints between nickel-chromium molybdenum alloys to stainless steels, carbon or low alloys steels
- Welding alloy 625

## DIAMETERS / PACKAGING

Diameter in (mm)	Length in (mm)	8 lb (3.6 kg) Can 24 lb (10.9 kg) Master Carton	10 lb (4.5 kg) Can 30 lb (13.6 kg) Master Can
3/32 (2.4)	12 (305)	EL112093632	EL112125634 EL112156634 EL112187634
1/8 (3.2)	14 (355)		
5/32 (4.0)	14 (355)		
3/16 (4.8)	14 (355)		

## MECHANICAL PROPERTIES - As Required per AWS A5.11

	Tensile Strength Mpa (ksi)	Elongation %
<b>Requirements</b> AWS A5.11/A5.11M:2010	690 (110 min)	30 min
<b>Typical Results<sup>(2)</sup></b> Tech-Rod® 112	790 (114)	42

## DEPOSIT COMPOSITION<sup>(1)</sup> - As Required per AWS A5.11

	%C	%Mn	%Fe	%P	%S	%Si
<b>Requirements</b> AWS ENiCrMo-3	0.10 max	1.0 max	7.0 max	0.03 max	0.02 max	0.75 max
<b>Typical Results<sup>(2)</sup></b> Tech-Rod® 112	0.05	0.5	1.9	0.01	0.003	0.33
	%Cu	%Ni	%Cr	%Nb+Ta	%Mo	%Other
<b>Requirements</b> AWS ENiCrMo-3	0.50 max	55.0 min	20.0 - 23.0	3.15 - 4.15	8.0 - 10.0	0.50 max
<b>Typical Results<sup>(2)</sup></b> Tech-Rod® 112	0.01	62.1	22.4	3.63	8.7	<0.5

## TYPICAL OPERATING PROCEDURES

Diameter in (mm)	Amperage	
	Flat	Vertical & Overhead
3/32 (2.4)	70-85	65-75
1/8 (3.2)	85-110	80-90
5/32 (4.0)	110-140	110-120
3/16 (4.8)	120-160	110-130

<sup>(1)</sup>Typical deposit composition. <sup>(2)</sup>See test results disclaimer  
 Safety Data Sheets (SDS) are available on our website at [www.lincolnelectric.com](http://www.lincolnelectric.com)

# TECH-ROD® 112LFe

Nickel ▪ AWS ENiCrMo-3

## KEY FEATURES

- A low iron version of the standard Tech-Rod® 112 covered electrode which is used to weld nickel-chromium-molybdenum alloys
- The product is designed to have less than 1% Iron (Fe) for overlay applications where low iron is required
- Product typically achieves Fe levels of 1% or less in a weld deposit

## POLARITY

DC+

## CONFORMANCES

**AWS A5.11:** ENiCrMo-3  
**UNS:** W86112  
**ASME SFA-5.11:** ENiCrMo-3

## TYPICAL APPLICATIONS

- Used extensively in overlay cladding where a similar chemical composition is required on the clad side
- Dissimilar joints between nickel-chromium molybdenum alloys to stainless steels, carbon or low alloys steels
- Welding alloy 625

## DIAMETERS / PACKAGING

Diameter in (mm)	Length in (mm)	10 lb (4.5 kg) Can 30 lb (13.6 kg) Master Can
1/8 (3.2)	14 (355)	EL112LFE125634
5/32 (4.0)	14 (355)	EL112LFE156634
3/16 (4.8)	14 (355)	EL112LFE187634

## MECHANICAL PROPERTIES - As Required per AWS A5.11

	Tensile Strength Mpa (ksi)	Elongation %
<b>Requirements</b> AWS A5.11/A5.11M:2010	690 (110 min)	30 min
<b>Typical Results<sup>(2)</sup></b> Tech-Rod® 112LFe	770 (111)	42

## DEPOSIT COMPOSITION<sup>(1)</sup> - As Required per AWS A5.11

	%C	%Mn	%Fe	%P	%S	%Si
<b>Requirements</b> AWS ENiCrMo-3	0.10 max	1.0 max	7.0 max	0.03	0.02 max	0.75 max
<b>Typical Results<sup>(2)</sup></b> Tech-Rod® 112LFe	0.02	0.5	0.9	0.01	0.01	0.3
	%Cu	%Ni	%Cr	%Nb+Ta	%Mo	%Other
<b>Requirements</b> AWS ENiCrMo-3	0.50 max	55.00 min	20.0 - 23.0	3.15 - 4.15	8.0 - 10.0	0.50 max
<b>Typical Results<sup>(2)</sup></b> Tech-Rod® 112LFe	0.01	62.7	22.5	3.72	8.7	-

## TYPICAL OPERATING PROCEDURES

Diameter in (mm)	Flat	Amperage	Vertical & Overhead
1/8 (3.2)	85-110		80-90
5/32 (4.0)	110-140		110-120
3/16 (4.8)	120-160		110-130

<sup>(1)</sup>Typical deposit composition. <sup>(2)</sup>See test results disclaimer  
 Safety Data Sheets (SDS) are available on our website at [www.lincolnelectric.com](http://www.lincolnelectric.com)

# TECH-ROD® 117

Nickel ▪ AWS ENiCrCoMo-1

## KEY FEATURES

- A covered electrode used for welding of nickel-chromium-cobalt-molybdenum alloys
- The deposited weld metal provides optimum strength and oxidation resistance between 1500°F to 2100°F, especially when welding on base metals of nickel-iron-chromium alloys
- Q2 Lot® - certificates showing actual deposit composition available online

## CONFORMANCES

<b>AWS A5.11:</b>	ENiCrCoMo-1
<b>UNS:</b>	W86117
<b>ASME SFA-A5.11:</b>	EniCrCoMo-1

## TYPICAL APPLICATIONS

- Overlay cladding where similar composition is required
- Turbine fabrication

## POLARITY

DC+

## DIAMETERS / PACKAGING

Diameter in (mm)	Length in (mm)	8 lb (3.6 kg) Can 24 lb (10.9 kg) Master Carton	10 lb (4.5 kg) Can 30 lb (13.6 kg) Master Can
3/32 (2.4)	12 (305)	EL117093632	EL117125634 EL117156634 EL117187634
1/8 (3.2)	14 (355)		
5/32 (4.0)	14 (355)		
3/16 (4.8)	14 (355)		

## MECHANICAL PROPERTIES - As Required per AWS A5.11

	Tensile Strength Mpa (ksi)	Elongation %
<b>Requirements</b> AWS A5.11/A5.11M:2010	620 (90min)	30 min
<b>Typical Results<sup>(2)</sup></b>	760 (110)	40

## DEPOSIT COMPOSITION<sup>(1)</sup> - As Required per AWS A5.11

	%C	%Mn	%Fe	%P	%S
<b>Requirements<sup>(2)</sup></b> AWS ENiCrCoMo-1	0.05 - 0.15	0.3 - 2.5	5.0 max	0.03 max	0.015 max
<b>Typical Results<sup>(2)</sup></b>	0.09	1.1	0.9	0.02	0.008
	%Si	%Cu	%Ni	%Co	
<b>Requirements</b> AWS ENiCrCoMo-1	0.75 max	0.50 max	Remainder	9.0 - 15.0	
<b>Typical Results<sup>(2)</sup></b>	0.47	0.01	50.7	11.4	
	%Cr	%Nb+Ta	%Mo	%Other	
<b>Requirements</b> AWS ENiCrCoMo-1	21.0 - 26.0	1.0 max	8.0 - 10.0	0.50 max	
<b>Typical Results<sup>(2)</sup></b>	24.7	0.9	9.4	-	

## TYPICAL OPERATING PROCEDURES

Diameter in (mm)	Amperage	
	Flat	Vertical & Overhead
3/32 (2.4)	70-85	65-75
1/8 (3.2)	85-110	80-90
5/32 (4.0)	110-140	100-120
3/16 (4.8)	120-160	110-130

<sup>(1)</sup>Typical deposit composition. <sup>(2)</sup>See test results disclaimer  
Safety Data Sheets (SDS) are available on our website at [www.lincolnelectric.com](http://www.lincolnelectric.com)

# TECH-ROD® 122

Nickel ▪ AWS ENiCrMo-10

## KEY FEATURES

- Excellent corrosion resistance in oxidizing as well as reducing media in a wide variety of chemical process environments
- Offers an outstanding resistance to stress corrosion cracking, pitting and crevice corrosion
- Q2 Lot® - certificates showing actual deposit composition available online

## POLARITY

DC+

## CONFORMANCES

**AWS A5.11:** ENiCrMo-10  
**ASME SFA-A5.11:** ENiCrMo-10  
**UNS:** W86122

## TYPICAL APPLICATIONS

- Used for welding of nickel-chromium-molybdenum alloys as well as for overlay cladding on carbon, low alloy or stainless steels
- Used for dissimilar joints between nickel-chromium-molybdenum alloys and stainless, carbon or low alloy steels

## DIAMETERS / PACKAGING

Diameter in (mm)	Length in (mm)	8 lb (3.6 kg) Can 24 lb (10.9 kg) Master Can	10 lb (4.5 kg) Can 30 lb (13.6 kg) Master Can
3/32 (2.4)	12 (305)	EL122093632	
1/8 (3.2)	14 (355)		EL122125634
5/32 (4.0)	14 (355)		EL122156634

## MECHANICAL PROPERTIES - As Required per AWS A5.11

	Tensile Strength Mpa (ksi)	Elongation %
<b>Requirements</b> AWS A5.11/A5.11M:2010	690 (100 min)	25 min
<b>Typical Results<sup>(2)</sup></b>	730 (105)	39

## DEPOSIT COMPOSITION<sup>(1)</sup> - As Required per AWS A5.11

	%C	%Mn	%Fe	%P	%S
<b>Requirements</b> AWS ENiCrMo-10	0.02 max	1.0 max	2.0 - 6.0	0.03 max	0.015 max
<b>Typical Results<sup>(2)</sup></b>	0.02	0.4	4.8	0.01	0.004
	%Si	%Cu	%Ni	%Co	%Cr
<b>Requirements</b> AWS ENiCrMo-10	0.2 max	0.50 max	Remainder	2.5 max	20.0 - 22.5
<b>Typical Results<sup>(2)</sup></b>	0.1	0.001	56.7	0.014	21.0
	%Nb+Ta	%Mo	%V	%W	%Other
<b>Requirements</b> AWS ENiCrMo-10	Not Specified	12.5 - 14.5	0.35 max	2.5 - 3.5	0.50 max
<b>Typical Results<sup>(2)</sup></b>	0.008	13.4	0.01	3.4	-

## TYPICAL OPERATING PROCEDURES

Diameter in (mm)	Amperage	
	Flat	Vertical & Overhead
3/32 (2.4)	70-85	65-75
1/8 (3.2)	85-110	80-90
5/32 (4.0)	110-140	100-120

<sup>(1)</sup>Typical deposit composition. <sup>(2)</sup>See test results disclaimer  
 Safety Data Sheets (SDS) are available on our website at [www.lincolnelectric.com](http://www.lincolnelectric.com)



# TECH-ROD® 141

Nickel ▪ AWS ENi-1

## KEY FEATURES

- Q2 Lot® - certificates showing actual deposit composition available online
- High nickel alloy
- Used for welding commercially pure nickel to themselves or steels

## POLARITY

DC+

## CONFORMANCES

**AWS A5.11:** ENi-1  
**ASME SFA-A5.11:** ENi-1  
**UNS:** W82141

## TYPICAL APPLICATIONS

- Used for joining Cu-Ni to stainless steels
- Welding of cast and wrought forms of pure Nickel alloys

## DIAMETERS / PACKAGING

Diameter in (mm)	Length in (mm)	8 lb (3.6 kg) Can 24 lb (10.9 kg) Master Carton	10 lb (4.5 kg) Can 30 lb (13.6 kg) Master Can
3/32 (2.4)	12 (305)	EL141093632	EL141125634 EL141156634 EL141187634
1/8 (3.2)	14 (355)		
5/32 (4.0)	14 (355)		
3/16 (4.8)	14 (355)		

## MECHANICAL PROPERTIES - As Required per AWS A5.11

	Tensile Strength Mpa (ksi)	Elongation %
<b>Requirements</b> AWS A5.11/A5.11M:2010	410 (60 min)	20 min
<b>Typical Results<sup>(2)</sup></b>	430 (63)	21

## DEPOSIT COMPOSITION<sup>(1)</sup> - As Required per AWS A5.11

	%C	%Mn	%Fe	%P	%S	%Si
<b>Requirements</b> AWS ENi-1	0.10 max	0.75 max	0.75 max	0.03 max	0.02 max	1.25 max
<b>Typical Results<sup>(2)</sup></b>	0.02	0.30	0.40	0.01	0.01	0.48
	%Cu	%Ni	%Ti	%Al	%Other	
<b>Requirements</b> AWS ENi-1	0.25 max	92.0 min	1.0 - 4.0	1.0 max	0.50 max	
<b>Typical Results<sup>(2)</sup></b>	0.01	96.7	1.2	0.03	-	

## TYPICAL OPERATING PROCEDURES

Diameter in (mm)	Flat	Amperage	Vertical & Overhead
3/32 (2.4)	70-85		65-75
1/8 (3.2)	85-110		80-90
5/32 (4.0)	110-140		100-120
3/16 (4.8)	120-160		110-130

<sup>(1)</sup>Typical deposit composition. <sup>(2)</sup>See test results disclaimer  
 Safety Data Sheets (SDS) are available on our website at [www.lincolnelectric.com](http://www.lincolnelectric.com)

# TECH-ROD® 182

Nickel ▪ AWS ENiCrFe-3

## KEY FEATURES

- Ideal for oxidation resistance and high temperature strength
- Q2 Lot® - certificates showing actual deposit composition available online
- Wide range of applications

## POLARITY

DC+

## CONFORMANCES

**AWS A5.11:** ENiCrFe-3  
**ASME SFA-A5.11:** ENiCrFe-3  
**UNS:** W86182

## TYPICAL APPLICATIONS

- Used for welding nickel-chromium-iron alloys to themselves
- Used for dissimilar welding between nickel-chromium-iron alloys to mild steel or stainless steel

## DIAMETERS / PACKAGING

Diameter in (mm)	Length in (mm)	8 lb (3.6 kg) Can 24 lb (10.9 kg) Master Carton	10 lb (4.5 kg) Can 30 lb (13.6 kg) Master Can
3/32 (2.4)	12 (305)	EL182093632	EL182125634
1/8 (3.2)	14 (355)		
5/32 (4.0)	14 (355)		
3/16 (4.8)	14 (355)		

## MECHANICAL PROPERTIES - As Required per AWS A5.11

	Tensile Strength Mpa (ksi)	Elongation %
<b>Requirements</b> AWS A5.11/A5.11M:2010	550 (80 min)	30 min
<b>Typical Results<sup>(2)</sup></b> Tech-Rod® 182	600 (87)	34

## DEPOSIT COMPOSITION<sup>(1)</sup> - As Required per AWS A5.11

	%C	%Mn	%Fe	%P	%S	%Si
<b>Requirements</b> AWS ENiCrFe-3	0.10 max	5.0 - 9.5	10.0 max	0.03 max	0.015 max	1.0 max
<b>Typical Results<sup>(2)</sup></b> Tech-Rod® 182	0.04	5.7	8.4	0.02	0.005	0.3
	%Cu	%Ni	%Ti	%Cr	%Nb+Ta	%Other
<b>Requirements</b> AWS ENiCrFe-3	0.50 max	59.0 min	1.0 max	13.0 - 17.0	1.0 - 2.5	0.50 max
<b>Typical Results<sup>(2)</sup></b> Tech-Rod® 182	0.04	68.5	0.1	15.1	1.2	<0.5

## TYPICAL OPERATING PROCEDURES

Diameter in (mm)	Amperage	
	Flat	Vertical & Overhead
3/32 (2.4)	70-85	65-75
1/8 (3.2)	85-110	80-90
5/32 (4.0)	110-140	100-120
3/16 (4.8)	120-160	110-130

<sup>(1)</sup>Typical deposit composition. <sup>(2)</sup>See test results disclaimer  
 Safety Data Sheets (SDS) are available on our website at [www.lincolnelectric.com](http://www.lincolnelectric.com)

# TECH-ROD® 187

Nickel ▪ AWS ECuNi

## KEY FEATURES

- A copper-nickel electrode for welding alloys of similar composition as well as 70/30 and 90/10 Cu/Ni alloys
- Q2 Lot® - certificates showing actual deposit composition available online

## POLARITY

DC+

## CONFORMANCES

**AWS A5.6:** ECuNi  
**ASME SFA-A5.11:** ECuNi  
**UNS:** W60715

## TYPICAL APPLICATIONS

- Marine applications
- Good resistance to the corrosive effects of sea water
- Used for the clad side of copper-nickel clad steels

## DIAMETERS / PACKAGING

Diameter in (mm)	Length in (mm)	8 lb (3.6 kg) Can 24 lb (10.9 kg) Master Carton	10 lb (4.5 kg) Can 30 lb (13.6 kg) Master Can
3/32 (2.4)	12 (305)	EL187093632	EL187125634
1/8 (3.2)	14 (355)		

## MECHANICAL PROPERTIES - As Required per AWS A5.6

	Tensile Strength Mpa (ksi)	Elongation %
<b>Requirements</b> AWS A5.11/A5.11M:2010	345 (50 min)	20 min
<b>Typical Results<sup>(2)</sup></b> Tech-Rod® 187	360 (52)	24

## DEPOSIT COMPOSITION<sup>(1)</sup> - As Required per AWS A5.6

	%Mn	%Fe	%P	%Si	%Cu
<b>Requirements</b> AWS ECuNi	1.00 - 2.50	0.40 - 0.75	0.020 max	0.50 max	Remainder
<b>Typical Results<sup>(2)</sup></b> Tech-Rod® 187	1.58	0.60	0.001	0.01	63.0
	%Ni	%Ti	%Pb	%Other	
<b>Requirements</b> AWS ECuNi	29.0 - 33.0	0.50 max	0.02 max	0.50 max	
<b>Typical Results<sup>(2)</sup></b> Tech-Rod® 187	30.4	0.24	0.001	<0.50	

## TYPICAL OPERATING PROCEDURES

Diameter in (mm)	Amperage	
	Flat	Vertical & Overhead
3/32 (2.4)	70-85	65-75
1/8 (3.2)	85-110	80-90

<sup>(1)</sup>Typical deposit composition. <sup>(2)</sup>See test results disclaimer  
 Safety Data Sheets (SDS) are available on our website at [www.lincolnelectric.com](http://www.lincolnelectric.com)

# TECH-ROD® 190

Nickel ■ AWS ENiCu-7

## KEY FEATURES

- Dissimilar applications include nickel alloys to copper-nickel alloys
- Q2 Lot® - certificates showing actual deposit composition available online

## POLARITY

DC+

## CONFORMANCES

**AWS A5.11:** ENiCu-7  
**ASME SFA-A5.11:** ENiCu-7  
**UNS:** W84190

## TYPICAL APPLICATIONS

- Welding nickel-copper alloys to themselves and to steel
- Used for overlay welding as well as for welding clad steels nickel-copper surfacing is required
- Welding nickel-copper alloys to themselves and stainless

## DIAMETERS / PACKAGING

Diameter in (mm)	Length in (mm)	8 lb (3.6 kg) Can 24 lb (10.9 kg) Master Carton	10 lb (4.5 kg) Can 30 lb (13.6 kg) Master Can
3/32 (2.4)	12 (305)	EL190093632	EL190125634
1/8 (3.2)	14 (355)		
5/32 (4.0)	14 (355)		
3/16 (4.8)	14 (355)		

## MECHANICAL PROPERTIES - As Required per AWS A5.11

	Tensile Strength Mpa (ksi)	Elongation %
<b>Requirements</b> AWS A5.11/A5.11M:2010	480 (70 min)	30 min
<b>Typical Results<sup>(2)</sup></b> Tech-Rod® 190	500 (72)	44

## DEPOSIT COMPOSITION<sup>(1)</sup> - As Required per AWS A5.11

	%C	%Mn	%Fe	%P	%S	%Si
<b>Requirements</b> AWS ENiCu-7	0.15	4.0 max	2.5 max	0.02 max	0.015 max	1.5 max
<b>Typical Results<sup>(2)</sup></b> Tech-Rod® 190	0.02	2.8	0.9	0.01	0.004	0.60
	%Cu	%Ni	%Al	%Ti	%Other	
<b>Requirements</b> AWS ENiCu-7	Remainder	62 - 69	0.75 max	1.0 max	0.5 max	
<b>Typical Results<sup>(2)</sup></b> Tech-Rod® 190	30	64.5	0.03	0.30	<0.5 max	

## TYPICAL OPERATING PROCEDURES

Diameter in (mm)	Amperage	
	Flat	Vertical & Overhead
3/32 (2.4)	70-85	65-75
1/8 (3.2)	85-110	80-90
5/32 (4.0)	110-140	100-120
3/16 (4.8)	120-160	110-130

<sup>(1)</sup>Typical deposit composition. <sup>(2)</sup>See test results disclaimer  
 Safety Data Sheets (SDS) are available on our website at [www.lincolnelectric.com](http://www.lincolnelectric.com)

# TECH-ROD® 276

Nickel ▪ AWS ENiCrMo-4

## KEY FEATURES

- Due to high molybdenum content, this alloy offers excellent resistance to stress corrosion cracking and pitting and crevice corrosion
- Q2 Lot® - certificates showing actual deposit composition available online
- This low carbon, nickel-chromium-molybdenum tungsten alloy can also be used for dissimilar welding between nickel base alloys and stainless steels, as well as for surfacing and cladding

## CONFORMANCES

<b>AWS A5.11:</b>	ENiCrMo-4
<b>ASME SFA-A5.11:</b>	ENiCrMo-4
<b>UNS:</b>	W80276

## TYPICAL APPLICATIONS

- Used for welding materials of similar composition

## POLARITY

DC+

## DIAMETERS / PACKAGING

Diameter in (mm)	Length in (mm)	8 lb (3.6 kg) Can 24 lb (10.9 kg) Master Carton	10 lb (4.5 kg) Can 30 lb (13.6 kg) Master Can
3/32 (2.4)	12 (305)	EL276093632	
1/8 (3.2)	14 (355)		EL276125634
5/32 (4.0)	14 (355)		EL276156634
3/16 (4.8)	14 (355)		EL276187634

## MECHANICAL PROPERTIES - As Required per AWS A5.11

	Tensile Strength Mpa (ksi)	Elongation %
<b>Requirements</b> AWS A5.11/A5.11M	690 (100 min)	25 min
<b>Typical Results<sup>(2)</sup></b> Tech-Rod® 276	750 (108)	46

## DEPOSIT COMPOSITION<sup>(1)</sup> - As Required per AWS A5.11

	%C	%Mn	%Fe	%P	%S	%Si	%Cu
<b>Requirements</b> AWS ENiCrMo-4	0.02 max	1.0 max	4.0 - 7.0	0.04 max	0.03 max	0.2 max	0.50 max
<b>Typical Results<sup>(2)</sup></b> Tech-Rod® 276	0.02	0.7	5.7	0.02	0.001	0.1	0.01
	%Ni	%Co	%Cr	%Mo	%V	%W	%Other
<b>Requirements</b> AWS ENiCrMo-4	Remainder	2.5 max	14.5 - 16.5	15.0 - 17.0	0.35 max	3.0 - 4.5	0.50 max
<b>Typical Results<sup>(2)</sup></b> Tech-Rod® 276	58.6	0.10	15.6	15.5	0.04	3.9	<0.50

## TYPICAL OPERATING PROCEDURES

Diameter in (mm)	Amperage	
	Flat	Vertical & Overhead
3/32 (2.4)	70-85	65-75
1/8 (3.2)	85-110	80-90
5/32 (4.0)	110-140	100-120
3/16 (4.8)	120-160	110-130

<sup>(1)</sup>Typical deposit composition. <sup>(2)</sup>See test results disclaimer  
Safety Data Sheets (SDS) are available on our website at [www.lincolnelectric.com](http://www.lincolnelectric.com)

# TECH-ROD® WELD A

Nickel ▪ AWS ENiCrFe-2

## KEY FEATURES

- Overlay cladding where a similar composition is needed
- Q2 Lot® - certificates showing actual deposit composition available online

## POLARITY

DC+

## CONFORMANCES

AWS A5: ENiCrFe-2

## TYPICAL APPLICATIONS

- For dissimilar welds between nickel-chromium-iron alloys to mild steels or stainless steels
- Furnace equipment
- Petrochemical plants

## DIAMETERS / PACKAGING

Diameter in (mm)	Length in (mm)	8 lb (3.6 kg) Can 24 lb (10.9 kg) Master Carton	10 lb (4.5 kg) Can 30 lb (13.6 kg) Master Can
3/32 (2.4)	12 (305)	ELWLDA093632	ELWLDA125634 ELWLDA156634 ELWLDA187634
1/8 (3.2)	14 (355)		
5/32 (4.0)	14 (355)		
3/16 (4.8)	14 (355)		

## MECHANICAL PROPERTIES - As Required per AWS A5.11

	Tensile Strength Mpa (ksi)	Elongation %
<b>Requirements</b> AWS A5.11/A5.11M	550 (80 min)	30 min
<b>Typical Results<sup>(2)</sup></b> Tech-Rod® Weld A	650 (94)	42

## DEPOSIT COMPOSITION<sup>(1)</sup> - As Required per AWS A5.11

	%C	%Mn	%Fe	%P	%S	%Si
<b>Requirements</b> AWS ENiCrFe-2	0.10 max	1.0 - 3.5	12.0 max	0.03 max	0.02 max	0.75 max
<b>Typical Results<sup>(2)</sup></b> Tech-Rod® Weld A	0.04	2.6	10.0	0.012	0.004	0.40
	%Cu	%Ni	%Cr	%Nb+Ta	%Mo	%Other
<b>Requirements</b> AWS ENiCrFe-2	0.50 max	62.0 min	13.0 - 17.0	0.5 - 3.0	0.5 - 2.5	0.50 max
<b>Typical Results<sup>(2)</sup></b> Tech-Rod® Weld A	0.06	67	15	2.0	0.96	0.50

## TYPICAL OPERATING PROCEDURES

Diameter in (mm)	Flat	Amperage	Vertical & Overhead
3/32 (2.4)	70-85		65-75
1/8 (3.2)	85-110		80-90
5/32 (4.0)	110-140		100-120
3/16 (4.8)	120-160		110-130

<sup>(1)</sup>Typical deposit composition. <sup>(2)</sup>See test results disclaimer  
Safety Data Sheets (SDS) are available on our website at [www.lincolnelectric.com](http://www.lincolnelectric.com)

# TECHALLOY® 55

Nickel ▪ AWS Similar to ENiFe-C I

## KEY FEATURES

- The welds are moderately hard and require carbide tipped tools for machining
- A preheat and inter-pass temperature of not less than 350°F (175°C) is required during welding on cast iron to minimize the potential for cracks
- Q2 Lot® - certificates showing actual deposit composition available online

## WELDING POSITIONS

All

## CONFORMANCES

Similar to AWS A5.15: ENiFe-C I

## TYPICAL APPLICATIONS

- Used for welding of cast irons to other cast irons as well as for joining cast irons to mild steels
- Readily used for the repair of castings

## SHIELDING GAS

MIG 75% Ar / 25% He

TIG 100% Ar

## DIAMETERS / PACKAGING

Diameter in (mm)	MIG 33 lb (15 kg) Steel Spool	TIG 10 lb (4.5 kg) Tube 30 lb (13.6 kg) Master Carton
0.035 (0.9)	MG55035667	
0.045 (1.1)	MG55045667	
1/8 (3.2)		TG55125638

## WIRE COMPOSITION - As Required per AWS A5.15

	%C	%Mn	%Si	%S	%Fe
<b>Requirements<sup>(1)</sup></b> AWS ENiFe-C I	2.0 max	2.5 max	4.0 max	0.03 max	Remainder
<b>Typical Results<sup>(2)</sup></b> Techalloy® 55	0.03	0.7	0.1	0.002	44.5
	%Ni	%Cu	%Al	%Other	
<b>Requirements<sup>(1)</sup></b> AWS ENiFe-C I	45-60	2.5 max	1.0 max	1.0 max	
<b>Typical Results<sup>(2)</sup></b> Techalloy® 55	54	0.1	0.1	<0.50	

## TYPICAL OPERATING PROCEDURES

Process / Polarity	Diameter in (mm)	Voltage (volts)	Amperage	Gas
MIG / DC+	0.035 (0.9)	26-29	150-190	75% Argon / 25% Helium
	0.045 (1.1)	28-32	180-220	

<sup>(1)</sup>Weld metal composition. <sup>(2)</sup>See test results disclaimer  
Safety Data Sheets (SDS) are available on our website at [www.lincolnelectric.com](http://www.lincolnelectric.com)

# TECHALLOY® 99

Nickel ▪ AWS ERNi-CI

## KEY FEATURES

- Welds produced are generally more machinable than a Tech-Rod® 55 deposit
- A preheat and inter-pass temperature of not less than 350°F (175°C) is required during welding on cast iron to minimize the potential for cracks
- Q2 Lot® - certificates showing actual deposit composition available online

## WELDING POSITIONS

All

## CONFORMANCES

AWS A5: ERNi-CI

## TYPICAL APPLICATIONS

- Used for welding of cast irons to other cast irons as well as for joining cast irons to mild steels and stainless steels
- Readily used for the repair of castings

## SHIELDING GAS

MIG 75% Ar / 25% He

TIG 100% Ar

## DIAMETERS / PACKAGING

Diameter in (mm)	MIG 33 lb (15 kg) Steel Spool	MIG 250 lb (113.4 kg) Accu-Trak® Drum	TIG 10 lb (4.5 kg) Tube 30 lb (13.6 kg) Master Carton
0.035 (0.9)	MG99035667		
0.045 (1.1)	MG99045667	MG99045684	
3/32 (2.4)			TG99093638

## WIRE COMPOSITION - As Required per AWS A5.15

	%C	%Mn	%Si	%S	%Fe
<b>Requirements</b> AWS ERNi-CI	1.0 max	2.5 max	0.75 max	0.03 max	4.0 max
<b>Typical Results<sup>(1)</sup></b> Techalloy® 99	0.003	0.07	0.09	0.001	0.1
	%Ni	%Cu	%Al	%Other	
<b>Requirements</b> AWS ERNi-CI	90 min	4.0 max	-	1.0 max	
<b>Typical Results<sup>(1)</sup></b> Techalloy® 99	99	0.02	0.1	<0.50	

## TYPICAL OPERATING PROCEDURES

Process / Polarity	Diameter in (mm)	Voltage (volts)	Amperage	Gas
MIG / DC+	0.035 (0.9)	24-27	150-190	75% Argon / 25% Helium
	0.045 (1.1)	25-30	200-290	

<sup>(1)</sup>See test results disclaimer.

Safety Data Sheets (SDS) are available on our website at [www.lincolnelectric.com](http://www.lincolnelectric.com)



# TECHALLOY® 208

Nickel ▪ AWS ERNi-1

## KEY FEATURES

- High nickel alloy with Al and Ti for sound deposits
- Q2 Lot® - Certificate showing actual deposit composition available online

## WELDING POSITIONS

All

## SHIELDING GAS

MIG 75% Ar / 25% He

TIG 100% Ar

## CONFORMANCES

AWS A5: ERNi-1

## TYPICAL APPLICATIONS

- For MIG and TIG welding of nickel 200 and 201
- Can be used for overlay on steel as well as repairing cast iron castings
- Used for dissimilar joints between nickel or nickel alloys to stainless or ferritic steels

## DIAMETERS / PACKAGING

Diameter in (mm)	MIG 33 lb (15 kg) Steel Spool	TIG 10 lb (4.5 kg) Tube 30 lb (13.6 kg) Master Carton
0.035 (0.9)	MG208035667	
0.045 (1.1)	MG208045667	
1/16 (1.6)	MG208062667	TG208062638
3/32 (2.4)		TG208093638
1/8 (3.2)		TG208125638

## WIRE COMPOSITION - As Required per AWS A5.14M

	%C	%Mn	%Fe	%P	%S	%Si
<b>Requirements</b> AWS ERNi-1	0.15 max	1.0 max	1.0 max	0.03 max	0.015 max	0.75 max
<b>Typical Results<sup>(1)</sup></b> Techalloy® 208	0.05	0.3	0.1	0.004	0.002	0.3
	%Cu	%Ni	%Al	%Ti	%Other	
<b>Requirements</b> AWS ERNi-1	0.25 max	93.0 min	1.5 max	2.0 - 3.5	0.50 max	
<b>Typical Results<sup>(1)</sup></b> Techalloy® 208	0.02	97.0	0.1	2.8	<0.50	

## TYPICAL OPERATING PROCEDURES

Process / Polarity	Diameter in (mm)	Voltage (volts)	Amperage	Gas
MIG / DC+	0.035 (0.9)	24-29	180-200	75% Argon / 25% Helium
	0.045 (1.1)	26-30	250-270	
	1/16 (1.6)	29-33	200-250	

<sup>(1)</sup>See test results disclaimer.

Safety Data Sheets (SDS) are available on our website at [www.lincolnelectric.com](http://www.lincolnelectric.com)

# TECHALLOY® 276

Nickel ▪ AWS ERNiCrMo-4

## KEY FEATURES

- Used for welding materials of similar composition
- Due to high molybdenum content, this alloy offers excellent resistance to stress corrosion cracking, pitting and crevice corrosion
- Q2 Lot® - Certificate showing actual deposit composition available online

## WELDING POSITIONS

All

## RECOMMENDED FLUXES

SAW P2007, P2000

## DIAMETERS / PACKAGING

Diameter in (mm)	MIG 33 lb (15 kg) Steel Spool	MIG 250 lb (113.4 kg) Accu-Trak® Drum	TIG 10 lb (4.5 kg) Tube 30 lb (13.6 kg) Master Carton	SAW 55 lb (25 kg) Basket
0.035 (0.9)	MG276035667	MG276035684		
0.045 (1.1)	MG276045667			
1/16 (1.6)	MG276062667			
3/32 (2.4)			TG276062638	
1/8 (3.2)			TG276093638	SA276093726
5/32 (4.0)			TG276125638	SA276125726
			TG276156638	

## CONFORMANCES

AWS A5: ERNiCrMo-4

CWB/CSA: ERNiCrMo-4

## TYPICAL APPLICATIONS

- Low carbon, nickel-chromium-molybdenum filler metal can also be used for dissimilar welding between nickel base alloys and stainless steels for cladding
- Used in LNG applications

## SHIELDING GAS

MIG 75% Ar / 25% He

TIG 100% Ar

## WIRE COMPOSITION - As Required per AWS A5.14M

	%C	%Mn	%Fe	%P	%S	%Si	%Cu
<b>Requirements</b> AWS ERNiCrMo-4	0.02 max	1.0 max	4.0 - 7.0	0.04 max	0.03 max	0.08 max	0.50 max
<b>Typical Results<sup>(1)</sup></b> Techalloy® 276	0.01	0.5	5.8	0.01	0.002	0.01	0.01
	%Ni	%Co	%Cr	%Mo	%V	%W	%Other
<b>Requirements</b> AWS ERNiCrMo-4	Remainder	2.5 max	14.5 - 16.5	15.0 - 17.0	0.35 max	3.0 - 4.5	0.50 max
<b>Typical Results<sup>(1)</sup></b> Techalloy® 276	58.0	0.07	15.5	16.0	0.04	4.0	<0.50

## TYPICAL OPERATING PROCEDURES

Process / Polarity	Diameter in (mm)	Voltage (volts)	Amperage	Gas / Flux
MIG / DC+	0.035 (0.9)	26-29	150-190	75% Argon / 25% Helium
	0.045 (1.1)	28-32	180-220	
	1/16 (1.6)	29-33	200-250	
SAW / DC+	3/32 (2.4)	28-30	275-350	Lincolnweld® P2007
	1/8 (3.2)	29-32	350-450	

<sup>(1)</sup>See test results disclaimer.

Safety Data Sheets (SDS) are available on our website at [www.lincolnelectric.com](http://www.lincolnelectric.com)

# TECHALLOY® 413

Nickel ▪ AWS ERCuNi

## KEY FEATURES

- This filler metal can be used for MIG overlay on steel after a first layer with Nickel 208
- Preheating is generally not required for this product
- Q2 Lot® -Certificate showing actual deposit composition available online

## WELDING POSITIONS

All

## CONFORMANCES

AWS A5: ERCuNi  
 ABS: ERCuNi  
 CWB/CSA: ERCuNi

## TYPICAL APPLICATIONS

- Used for MIG and TIG of 70/30, 80/20 and 90/10 copper-nickel alloys

## SHIELDING GAS

MIG 75% Ar / 25% He  
 TIG 100% Ar

## DIAMETERS / PACKAGING

Diameter in (mm)	MIG 33 lb (15 kg) Steel Spool	TIG 10 lb (4.5 kg) Tube 30 lb (13.6 kg) Master Carton
0.035 (0.9)	MG413035667	
0.045 (1.1)	MG413045667	
1/16 (1.6)	MG413062667	
3/32 (2.4)		TG413062638
1/8 (3.2)		TG413093638
		TG413125638

## WIRE COMPOSITION - As Required per AWS A5.7

	%Cu	%Mn	%Fe	%Si	%Ni
<b>Requirements</b> AWS ERCuNi	Remainder	1.0 max	0.40 - 0.75	0.25 max	29 - 32
<b>Typical Results<sup>(1)</sup></b> Techalloy® 413	67.5	0.7	0.55	0.1	30
	%P	%Pb	%Ti	%Other	
<b>Requirements</b> AWS ERCuNi	0.02 max	0.02 max	0.20 - 0.50	0.50 max	
<b>Typical Results<sup>(1)</sup></b> Techalloy® 413	0.006	0.003	0.25	<0.50	

## TYPICAL OPERATING PROCEDURES

Process / Polarity	Diameter in (mm)	Voltage (volts)	Amperage	Gas
MIG / DC+	0.035 (0.9)	25-29	150-190	75% Argon / 25% Helium
	0.045 (1.1)	25-28	180-240	
	1/16 (1.6)	29-33	200-250	

<sup>(1)</sup>See test results disclaimer.

Safety Data Sheets (SDS) are available on our website at [www.lincolnelectric.com](http://www.lincolnelectric.com)

# TECHALLOY® 418

Nickel ▪ AWS ERNiCu-7

## KEY FEATURES

- Used for MIG, TIG and SAW welding of copper alloys
- Dissimilar welding applications include joining Nickel 200 to copper-nickel alloys
- Q2 Lot® -Certificate showing actual deposit composition available online

## WELDING POSITIONS

All

## RECOMMENDED FLUXES

SAW P2000

## CONFORMANCES

AWS A5: ERNiCu-7

CWB/CSA: ERNiCu-7

## TYPICAL APPLICATIONS

Marine

## SHIELDING GAS

MIG 75% Ar / 25% He

TIG 100% Ar

## DIAMETERS / PACKAGING

Diameter in (mm)	MIG 33 lb (15 kg) Steel Spool	TIG 10 lb (4.5 kg) Tube 30 lb (13.6 kg) Master Carton	SAW 55 lb (25 kg) Coil
0.035 (0.9)	MG418035667		
0.045 (1.1)	MG418045667		
1/16 (1.6)	MG418062667	TG418062638	
3/32 (2.4)		TG418093638	SA418093726
1/8 (3.2)		TG418125638	SA418125726

## WIRE COMPOSITION - As Required per AWS A5.14M

	%C	%Mn	%Fe	%P	%S	%Si
<b>Requirements</b> AWS ERNiCu-7	0.15 max	4.0 max	2.5 max	0.02 max	0.015 max	1.25 max
<b>Typical Results<sup>(1)</sup></b> Techalloy® 418	0.07	3.0	0.1	0.002	0.002	0.31
	%Cu	%Ni	%Al	%Ti	%Others	
<b>Requirements</b> AWS ERNiCu-7	Remainder	62.0 - 69.0	1.25 max	1.5 - 3.0	0.50 max	
<b>Typical Results<sup>(1)</sup></b> Techalloy® 418	30	64	0.15	1.8	<0.50	

## TYPICAL OPERATING PROCEDURES

Process / Polarity	Diameter in (mm)	Voltage (volts)	Amperage	Gas / Flux
MIG / DC+	0.035 (0.9)	25-28	160-200	75% Argon / 25% Helium
	0.045 (1.1)	26-30	190-230	
	1/16 (1.6)	29-33	200-250	
SAW / DC+	3/32 (2.4)	28-30	275-350	Lincolnweld® P2000
	1/8 (3.2)	29-32	350-450	

<sup>(1)</sup>See test results disclaimer.  
Safety Data Sheets (SDS) are available on our website at [www.lincolnelectric.com](http://www.lincolnelectric.com)

# TECHALLOY® 606

Nickel ▪ AWS ERNiCr-3

## KEY FEATURES

- Used for MIG, TIG and SAW welding of base materials such as ASTM B163, B166, B167 and B168 alloys which have UNS Number N06600
- Suitable for applications ranging from cryogenic to high temperatures making this alloy one of the most used in the nickel family
- Q2 Lot® - Certificate showing actual deposit composition available online

## WELDING POSITIONS

All

## RECOMMENDED FLUXES

SAW P2000

## CONFORMANCES

AWS A5: ERNiCr-3

CWB/CSA: ERNiCr-3

## TYPICAL APPLICATIONS

- This filler metal can also be used for dissimilar welding applications between various nickel alloys and stainless or carbon steels, as well as for overlay

## SHIELDING GAS

MIG 75% Ar / 25% He

TIG 100% Ar

## DIAMETERS / PACKAGING

Diameter in (mm)	MIG 33 lb (15 kg) Steel Spool	TIG 10 lb (4.5 kg) Tube 30 lb (13.6 kg) Master Carton	SAW 55 lb (25 kg) Coil
0.035 (0.9)	MG606035667		
0.045 (1.1)	MG606045667		
1/16 (1.6)	MG606062667		
5/64 (2.0)		TG606062638	
3/32 (2.4)		TG606078638	
1/8 (3.2)		TG606093638	SA606093726
5/32 (4.0)		TG606125638	SA606125726
		TG606156638	

## WIRE COMPOSITION - As Required per AWS A5.14M

	%C	%Mn	%Fe	%P	%S	%Si
<b>Requirements</b> AWS ERNiCr-3	0.10 max	2.5 - 3.5	3.0 max	0.03 max	0.015	0.50 max
<b>Typical Results<sup>(1)</sup></b> Techalloy® 606	0.04	2.8	1.5	0.003	0.002	0.09
	%Cu	%Ni	%Ti	%Cr	%Nb + Ta	%Others
<b>Requirements</b> AWS ERNiCr-3	0.50 max	67.0 min	0.75 max	18.0 - 22.0	2.0 - 3.0	0.50 max
<b>Typical Results<sup>(1)</sup></b> Techalloy® 606	0.03	73.0	0.40	20.0	2.4	<0.50

## TYPICAL OPERATING PROCEDURES

Process / Polarity	Diameter in (mm)	Voltage (volts)	Amperage	Gas / Flux
MIG / DC+	0.035 (0.9)	26-29	150-190	75% Argon / 25% Helium
	0.045 (1.1)	28-32	180-220	
	1/16 (1.6)	29-33	200-250	
SAW / DC+	3/32 (2.4)	28-30	275-350	Lincolnweld® P2000
	1/8 (3.2)	29-32	350-450	

<sup>(1)</sup>See test results disclaimer.

Safety Data Sheets (SDS) are available on our website at [www.lincolnelectric.com](http://www.lincolnelectric.com)

# TECHALLOY® 617

Nickel ▪ AWS ERNiCrCoMo-1

## KEY FEATURES

- The weld metal provides optimum strength and oxidation resistance from 1500°F (815°C) up to 2100°F (1150°C)
- Q2 Lot® - Certificate showing actual deposit composition available online

## WELDING POSITIONS

All

## CONFORMANCES

AWS A5: ERNiCrCoMo-1  
CWB/CSA: ERNiCrCoMo-1

## TYPICAL APPLICATIONS

- Used for MIG, TIG and SAW welding of nickel-chrome-cobalt-molybdenum alloys

## SHIELDING GAS

MIG 75% Ar / 25% He  
TIG 100% Ar

## RECOMMENDED FLUXES

SAW P2000

## DIAMETERS / PACKAGING

Diameter in (mm)	MIG 33 lb (15 kg) Steel Spool	TIG 10 lb (4.5 kg) Tube 30 lb (13.6 kg) Master Carton	SAW 55 lb (25 kg) Coil
0.035 (0.9)	MG617035667		
0.045 (1.1)	MG617045667		
1/16 (1.6)	MG617062667	TG617062638	
3/32 (2.4)		TG617093638	
1/8 (3.2)		TG617125638	SA617125726
5/32 (4.0)		TG617156638	

## WIRE COMPOSITION - As Required per AWS A5.14M

	%C	%Mn	%Fe	%P	%S	%Si	%Cu
<b>Requirements</b> AWS ERNiCrCoMo-1	0.05 - 0.15	1.0 max	3.0 max	0.03 max	0.015 max	1.0 max	0.50 max
<b>Typical Results<sup>(1)</sup></b> Techalloy® 617	0.07	0.4	0.3	0.001	0.003	0.3	0.09
	%Ni	%Co	%Al	%Ti	%Cr	%Mo	%Other
<b>Requirements</b> AWS ERNiCrCoMo-1	Remainder	10.0 - 15.0	0.8 - 1.5	0.60 max	20.0 - 24.0	8.0 - 10.0	0.50 max
<b>Typical Results<sup>(1)</sup></b> Techalloy® 617	54	12.0	1.0	0.4	22.0	8.7	<0.50

## TYPICAL OPERATING PROCEDURES

Process / Polarity	Diameter in (mm)	Voltage (volts)	Amperage	Gas / Flux
MIG / DC+	0.035 (0.9)	26-29	150-190	75% Argon / 25% Helium
	0.045 (1.1)	28-32	180-220	
	1/16 (1.6)	29-33	200-250	
SAW / DC+	1/8 (3.2)	29-32	350-450	Lincolnweld® P2000

<sup>(1)</sup>See test results disclaimer.  
Safety Data Sheets (SDS) are available on our website at [www.lincolnelectric.com](http://www.lincolnelectric.com)

# TECHALLOY® 622

Nickel ▪ AWS ERNiCrMo-10

## KEY FEATURES

- Excellent corrosion resistance in oxidizing as well as reducing media in a wide variety of chemical process environments
- Outstanding resistance to stress corrosion cracking, pitting and crevice corrosion
- Q2 Lot® - Certificate showing actual deposit composition available online

## WELDING POSITIONS

All

## RECOMMENDED FLUXES

SAW P2000

## CONFORMANCES

AWS A5: ERNiCrMo-10

CWB/CSA: ERNiCrMo-10

## TYPICAL APPLICATIONS

- A nickel based alloy with chromium, molybdenum, and tungsten as the principal alloying elements
- Used for cladding overlay as well as thermal spray applications

## SHIELDING GAS

MIG 75% Ar / 25% He

TIG 100% Ar

## DIAMETERS / PACKAGING

Diameter in (mm)	MIG 33 lb (15 kg) Steel Spool	TIG 10 lb (4.5 kg) Tube 30 lb (13.6 kg) Master Carton	SAW 55 lb (25 kg) Basket
0.035 (0.9)	MG622035667		
0.045 (1.1)	MG622045667		
1/16 (1.6)	MG622062667	TG622062638	
3/32 (2.4)		TG622093638	SA622093726
1/8 (3.2)		TG622125638	

## WIRE COMPOSITION - As Required per AWS A5.14M

	%C	%Mn	%Fe	%P	%S	%Si	%Cu
<b>Requirements</b> AWS ERNiCrMo-10	0.015 max	0.50 max	2.0 - 6.0	0.02 max	0.010 max	0.08 max	0.50 max
<b>Typical Results<sup>(1)</sup></b> Techalloy® 622	0.01	0.14	4.4	0.003	0.002	0.07	0.01
	%Ni	%Co	%Cr	%Mo	%V	%W	%Other
<b>Requirements</b> AWS ERNiCrMo-10	Remainder	2.50 max	20.0 - 22.5	12.5 - 14.5	0.35 max	2.5 - 3.5	0.50 max
<b>Typical Results<sup>(1)</sup></b> Techalloy® 622	56	0.1	21.4	13.8	0.02	3.1	<0.50

## TYPICAL OPERATING PROCEDURES

Process / Polarity	Diameter in (mm)	Voltage (volts)	Amperage	Gas / Flux
MIG / DC+	0.035 (0.9)	26-29	140-190	75% Argon / 25% Helium
	0.045 (1.1)	28-32	160-200	
	1/16 (1.6)	29-33	200-250	
SAW / DC+	3/32 (2.4)	28-30	275-350	Lincolnweld® P2000

<sup>(1)</sup>See test results disclaimer.

Safety Data Sheets (SDS) are available on our website at [www.lincolnelectric.com](http://www.lincolnelectric.com)

# TECHALLOY® 625

Nickel ▪ AWS ERNiCrMo-3

## KEY FEATURES

- Designed to match the composition and properties of Alloy 625
- The Ni-Cr-Mo alloy system provides excellent resistance to oxidizing and reducing environments
- The high molybdenum content provides good stress, pitting and crevice corrosion resistance
- Q2 Lot® - Certificate showing actual deposit composition available online
- Most popular nickel alloy for cladding
- Provides high temperature strength and structural stability

## WELDING POSITIONS

All

## RECOMMENDED FLUXES

SAW P2000

## DIAMETERS / PACKAGING

Diameter in (mm)	MIG 33 lb (15 kg) Steel Spool	MIG 250 lb (113.4 kg) Accu-Trak® Drum	MIG 300 lb (136 kg) Speed-Feed® Reel	TIG 10 lb (4.5 kg) Tube 30 lb (13.6 kg) Master Carton	SAW 55 lb (25 kg) Basket	SAW 500 lb (227 kg) Speed Feed® Drum
0.035 (0.9)	MG625035667	MG625045684	MG625062693	TG625062638 TG625093638 TG625125638 TG625156638	SA625093726 SA625125726	SA625093692 SA625125692 SA625156692*
0.045 (1.1)	MG625045667					
1/16 (1.6)	MG625062667					
3/32 (2.4)						
1/8 (3.2)						
5/32 (4.0)						

\*Available upon request

## WIRE COMPOSITION - As Required per AWS A5.14M

	%C	%Mn	%Fe	%P	%S	%Si	%Cu
<b>Requirements</b> AWS ERNiCrMo-3	0.10 max	0.50 max	5.0 max	0.02 max	0.015 max	0.50 max	0.50 max
<b>Typical Results<sup>(1)</sup></b> Techalloy® 625	0.02	0.1	0.4	0.005	0.001	0.14	0.01
	%Ni	%Al	%Ti	%Cr	%Nb+Ta	%Mo	%Other
<b>Requirements</b> AWS ERNiCrMo-3	58.0 min	0.40 max	0.40 max	20.0 - 23.0	3.15 - 4.15	8.0 - 10.0	0.50 max
<b>Typical Results<sup>(1)</sup></b> Techalloy® 625	64	0.1	0.17	21.7	3.8	8.5	<0.50

## TYPICAL OPERATING PROCEDURES

Process / Polarity	Diameter in (mm)	Voltage (volts)	Amperage	Gas / Flux
MIG / DC+	0.035 (0.9)	26-29	150-190	75% Argon / 25% Helium
	0.045 (1.1)	28-32	180-220	
	1/16 (1.6)	29-33	200-250	
SAW / DC+	3/32 (2.4)	28-30	275-350	Lincolnweld® P2000
	1/8 (3.2)	29-33	350-450	

<sup>(1)</sup>See test results disclaimer.

Safety Data Sheets (SDS) are available on our website at [www.lincolnelectric.com](http://www.lincolnelectric.com)

## CONFORMANCES

<b>AWS A5:</b>	ERNiCrMo-3
<b>ABS:</b>	ERNiCrMo-3
<b>ISO:</b>	S Ni 6625 (NiCr22Mo9Nb)

## TYPICAL APPLICATIONS

- Used for MIG, TIG and SAW welding of nickel-chromium-molybdenum alloys
- This filler metal may be used for cladding and welding dissimilar base metals such as Ni-Cr-Mo alloys to stainless and carbon steels

## SHIELDING GAS

MIG 75% Ar / 25% He

TIG 100% Ar



# TECHALLOY® 686

Nickel ■ AWS ERNiCrMo-14

## KEY FEATURES

- Used for TIG, MIG and SAW welding of base materials such as ASTM B574, B575, B619, B622, and B628 having a UNS number of N06686
- Suitable for highly acidic and high heat environments
- Q2 Lot® - Certificate showing actual deposit composition available online

## WELDING POSITIONS

All

## RECOMMENDED FLUX

SAW P2000

## CONFORMANCES

AWS A5: ERNiCrMo-14

## TYPICAL APPLICATIONS

- Typically used in pollution control (flue gas desulfurization), chemical processing, power generation, pulp and paper manufacturing and waste management

## SHIELDING GAS

MIG 75% Ar / 25% He, 100% Ar

TIG 100% Ar

## DIAMETERS / PACKAGING

Diameter in (mm)	MIG 33 lb (15 kg) Steel Spool	TIG 10 lb (4.5 kg) Tube 30 lb (13.6 kg) Master Carton	SAW 55 lb (25 kg) Coil
0.035 (0.9)	MG686035667		
0.045 (1.1)	MG686045667		
1/16 (1.6)	MG686062667	TG686062638	
3/32 (2.4)		TG686093638	SA686093726
1/8 (3.2)		TG686125638	SA686125726

## WIRE COMPOSITION<sup>(1)</sup> – As Required per AWS A5.14M: 2018

	%C	%Mn	%Fe	%P	%S	%Si
<b>Requirements</b> AWS ERNiCrMo-14	0.01	1.0	5.0	0.02	0.02	0.08
	%Mo	%Ni	%Ti	%Cr	%W	
<b>Requirements</b> AWS ERNiCrMo-14	15.0-17.0	Balance	0.25	19.0-23.0	3.0-4.4	

## TYPICAL OPERATING PROCEDURES

Process / Polarity	Diameter in (mm)	WFS	Voltage (volts)	Current (Amps)	Gas / Flux
<b>MIG / DC+</b>	0.035 (0.9) 0.045 (1.1)	400-600 350-450	27-30 29-32	150-190 240-300	75% Ar / 25% He
<b>SAW / DC+</b>	3/32 (2.4) 1/8 (3.2)		28-30 29-33	275-350 350-450	Lincolnweld® P2000

<sup>(1)</sup>Typical deposit composition  
Safety Data Sheets (SDS) are available on our website at [www.lincolnelectric.com](http://www.lincolnelectric.com)

# TECHALLOY® 718

Nickel ▪ AWS ERNiFeCr-2

## KEY FEATURES

- This alloy can be age hardened to higher strengths
- Q2 Lot® - Certificate showing actual deposit composition available online

## WELDING POSITIONS

All

## SHIELDING GAS

MIG 75% Ar / 25% He

TIG 100% Ar

## CONFORMANCES

AWS A5: ERNiFeCr-2

CWB/CSA: ERNiFeCr-2

## TYPICAL APPLICATIONS

- Used for welding alloys 718, 706 and X-750
- Mainly used for welding high strength aircraft components and liquid rocket components involving cryogenic temperatures

## DIAMETERS / PACKAGING

Diameter in (mm)	MIG 33 lb (15 kg) Steel Spool	TIG 10 lb (4.5 kg) Tube 30 lb (13.6 kg) Master Carton
0.035 (0.9)	MG718035667	
0.045 (1.1)	MG718045667	
1/16 (1.6)	MG718062667	
3/32 (2.4)		TG718093638
1/8 (3.2)		TG718125638

## WIRE COMPOSITION - As Required per AWS A5.14M

	%C	%Mn	%Fe	%P	%S
<b>Requirements</b> AWS ERNiFeCr-2	0.08 max	0.35 max	Remainder	0.015 max	0.015 max
<b>Typical Results<sup>(1)</sup></b> Techalloy® 718	0.05	0.10	20	0.01	0.001
	%Si	%Cu	%Ni	%Al	%Ti
<b>Requirements</b> AWS ERNiFeCr-2	0.35 max	0.30 max	50.0 - 55.0	0.20 - 0.80	0.65 - 1.15
<b>Typical Results<sup>(1)</sup></b> Techalloy® 718	0.06	0.01	53	0.45	1.0
	%Cr	%Nb + Ta	%Mo	%Other	
<b>Requirements</b> AWS ERNiFeCr-2	17.0 - 21.0	4.75 - 5.50	2.80 - 3.30	0.50 max	
<b>Typical Results<sup>(1)</sup></b> Techalloy® 718	17.4	5.0	3.0	<0.50	

## TYPICAL OPERATING PROCEDURES

Process / Polarity	Diameter in (mm)	Voltage (volts)	Amperage	Gas
MIG / DC+	0.035 (0.9)	26-29	150-190	75% Argon / 25% Helium
	0.045 (1.1)	28-32	180-220	
	1/16 (1.6)	29-33	200-250	

<sup>(1)</sup>See test results disclaimer.

Safety Data Sheets (SDS) are available on our website at [www.lincolnelectric.com](http://www.lincolnelectric.com)

# TECHALLOY® 825

Nickel ▪ AWS ERNiFeCr-1

## KEY FEATURES

- Used for MIG and TIG welding of nickel-chromium-molybdenum-copper alloys
- Can be used to overlay cladding where similar chemical composition is required
- Q2 Lot® - Certificate showing actual deposit composition available online

## WELDING POSITIONS

All

## CONFORMANCES

**AWS A5:** ERNiFeCr-1  
**ABS:** ERNiFeCr-1  
**CWB/CSA:** ERNiFeCr-1

## TYPICAL APPLICATIONS

- Used for welding the nickel-iron-chromium-molybdenum-copper alloy (ASTM B 423 having UNS number N08825) to itself <sup>(2)</sup>

## SHIELDING GAS

**MIG** 75% Ar / 25% He  
**TIG** 100% Ar

## DIAMETERS / PACKAGING

Diameter in (mm)	MIG 33 lb (15 kg) Steel Spool	TIG 10 lb (4.5 kg) Tube 30 lb (13.6 kg) Master Carton
0.035 (0.9)	MG825035667	
0.045 (1.1)	MG825045667	
1/16 (1.6)	MG825062667	
3/32 (2.4)		TG825062638
1/8 (3.2)		TG825093638
		TG825125638

## WIRE COMPOSITION - As Required per AWS A5.14M

	%C	%Mn	%Fe	%P	%S	%Si	%Cu
<b>Requirements</b> AWS ERNiFeCr-1	0.05 max	1.0 max	22.0 min	0.03 max	0.03 max	0.50 max	1.5 - 3.0
<b>Typical Results<sup>(1)</sup></b> Techalloy® 825	0.01	0.01	27	0.02	0.002	0.2	2.1
	%Ni	%Al	%Ti	%Cr	%Mo	%Other	
<b>Requirements</b> AWS ERNiFeCr-1	38.0 - 46.0	0.20 max	0.6 - 1.2	19.5 - 23.5	2.5 - 3.5	0.50 max	
<b>Typical Results<sup>(1)</sup></b> Techalloy® 825	42.0	0.8	0.8	22.1	3.0	<0.50	

## TYPICAL OPERATING PROCEDURES

Process / Polarity	Diameter in (mm)	Voltage (volts)	Amperage	Gas
MIG / DC+	0.035 (0.9)	26-29	150-190	75% Argon / 25% Helium
	0.045 (1.1)	28-32	180-220	
	1/16 (1.6)	29-33	200-250	

<sup>(1)</sup>See test results disclaimer. <sup>(2)</sup>Extracted from AWS A5.14/A5.14M Section A7.5.1. Safety Data Sheets (SDS) are available on our website at [www.lincolnelectric.com](http://www.lincolnelectric.com)

# TECHALLOY® X

Nickel ▪ AWS ERNiCrMo-2

## KEY FEATURES

- The Ni-Cr-Mo alloy system provides excellent resistance to oxidizing and reducing environments
- Meets AMS 5798G chemical and tolerance requirements
- Q2 Lot® -Certificate showing actual wire composition available online

## WELDING POSITIONS

All

## CONFORMANCES

AWS A5: ERNiCrMo-2

## TYPICAL APPLICATIONS

- Used for MIG and TIG welding of nickel-chromium-molybdenum alloys

## SHIELDING GAS

MIG 75% Ar / 25% He or 100% Ar

TIG 100% Ar

## DIAMETERS / PACKAGING

Diameter in (mm)	MIG 33 lb (14.9 kg) Wire Basket	TIG 10 lb (4.5 kg) Tube 30 lb (13.6 kg) Master Carton
0.035 (0.9)	MGX035667	
0.045 (1.1)	MGX045667	
1/16 (1.6)		TGX062638
3/32 (2.4)		TGX093638
1/8 (3.2)		TGX125638

## WIRE COMPOSITION - As Required per AWS A5.14

	%C	%Mn	%Si	%S	%P	%Cr	%Ni
<b>Requirements</b>							
AWS ERNiCrMo-2	0.05 - 0.15	1.0 max	1.0 max	0.03 max	0.04 max	20.5 - 23.0	remainder
<b>Typical Results<sup>(1)</sup></b>	0.10	0.03	0.10	<0.001	0.01	21.7	48
	%Mo	%Cu	%Fe	%Co	%W	Other Elements, Total %	
<b>Requirements</b>							
AWS ERNiCrMo-2	8.0 - 10.0	0.50 max	17.0 - 20.0	0.5 - 2.5	0.2 - 1.0	0.50 max	
<b>Typical Results<sup>(1)</sup></b>	9.3	0.01	18.6	1.9	0.6	<0.50	

<sup>(1)</sup>See test results disclaimer

# SUPERCORE® 625P

Nickel ▪ AWS ENiCrMo3T1-4

## KEY FEATURES

- Smooth all position weldability
- Vacuum sealed foil package
- Excellent slag removal
- Q2 Lot® - Certificate showing actual deposit composition available online

## WELDING POSITIONS

All

## SHIELDING GAS

75-80% Argon / Balance CO<sub>2</sub>  
100% CO<sub>2</sub>

## CONFORMANCES

**AWS A5.34:** ENiCrMo3T1-4  
**UNS** W86625

## TYPICAL APPLICATIONS

- Furnace Equipment
- Petrochemical
- 9% Ni for LNG storage tanks
- Dissimilar welds between Nickel alloys, stainless steels, and mild steel

## DIAMETERS / PACKAGING

Diameter mm (in)	15 kg (33 lb) Spool
1.2 (0.047)	ED034130, SC625P-12*

\*The Metrode part number will be replacing the current EDO numbers after the inventory has been depleted.

## MECHANICAL PROPERTIES<sup>(1)</sup> - As Required per AWS A5.34

	Yield Strength <sup>(2)</sup> MPa (ksi)	Tensile Strength MPa (ksi)	Elongation %	Charpy V-Notch J (ft·lbf) @ 20 °C (68 °F)
<b>Requirements</b> AWS ENiCrMo3T1-4	–	690 min (100)	25 min	–
<b>Typical Results<sup>(3)</sup></b> As-Welded	500 (72)	770 (112)	46	95 (70)

## DEPOSIT COMPOSITION - As Required per AWS A5.34

	%C	%Mn	%Si	%S	%P	%Cr
<b>Requirements</b> AWS ENiCrMo3T1-4	0.10 max	0.50 max	0.50 max	0.015 max	0.02 max	20.0 - 23.0
<b>Typical Results<sup>(3)</sup></b>	0.02	0.3	0.2	0.005	0.005	21
	%Ni	%Mo	%Nb	%Cu	%Ti	%Fe
<b>Requirements</b> AWS ENiCrMo3T1-4	58.0 min	8.0 - 10.0	3.15 - 4.15	0.50 max	0.40 max	5.0 max
<b>Typical Results<sup>(3)</sup></b>	66	8.5	3.4	0.02	0.2	1.0

## TYPICAL OPERATING PROCEDURES

Diameter / Polarity in (mm) / DC+	Voltage (volts)	Amperage	Typical	Stickout in (mm)
1.2 (0.047) DC+	25 - 28V	150 - 180A	160A, 26V	5/8-1" (15-20 mm)

<sup>(1)</sup>Typical deposit composition. <sup>(2)</sup>Measured with 0.2% offset. <sup>(3)</sup>See test results disclaimer  
NOTE: Additional test data available upon request.

# HARDFACING

## *Stick (SMAW) Electrode*

### **Cobalt**

Weartech® WT-1 SMAW .....	H-1
Weartech® WT-6 SMAW .....	H-2
Weartech® WT-12 SMAW .....	H-3
Weartech® WT-21 SMAW .....	H-4

### **Build-Up**

Wearshield® BU .....	H-5
----------------------	-----

### **Metal-to-Metal Wear**

Wearshield® MI .....	H-6
Wearshield® Mangjet® .....	H-7

### **Severe Impact**

Wearshield® 15CrMn .....	H-8
Wearshield® FROG MANG® .....	H-9
Wearshield® Super Rail™ .....	H-10

### **Abrasion and Impact**

Wearshield® ABR.....	H-11
Wearshield® 44 .....	H-12

### **Metal-to-Earth Wear**

Wearshield® ME.....	H-13
---------------------	------

### **Severe Abrasion**

Wearshield® 60 .....	H-14
Weartech® SHS® 9700E .....	H-15

### **Maintenance and Repair**

Blue Max® 2100.....	H-16
---------------------	------

## *TIG (GTAW) Cut Lengths*

### **Cobalt**

Weartech® WT-1 TIG .....	H-17
Weartech® WT-6 TIG .....	H-18
Weartech® WT-12 TIG .....	H-19
Weartech® WT-21 TIG .....	H-20

### **Nickel**

Weartech® WT-40 TIG.....	H-21
Weartech® WT-50 TIG .....	H-22
Weartech® WT-56 TIG .....	H-23
Weartech® WT-60 TIG .....	H-24

## *Metal-Cored (GMAW-C) Wire*

### **Severe Abrasion**

Lincore® 57-G.....	H-25
Lincore® 60-G.....	H-26
Lincore® 70-G.....	H-27

### **Cobalt**

Weartech® WT-1 GMAW-C.....	H-28
Weartech® WT-6 GMAW-C.....	H-29
Weartech® WT-12 GMAW-C .....	H-30
Weartech® WT-21 GMAW-C .....	H-31

## *Metal-Cored Submerged Arc Wire*

### **Build-Up**

Lincore® 30-S .....	H-32
---------------------	------

### **Metal-to-Metal, Build Up**

Lincore® 32-S .....	H-33
Lincore® 35-S .....	H-34

### **Metal-to-Metal**

Lincore® 40-S .....	H-35
Lincore® 42-S .....	H-36

### **Roll Rebuilding, Build Up**

Lincore® 20 .....	H-37
Lincore® 4130.....	H-38
Lincore® 8620.....	H-39

# HARDFACING

## Roll Rebuilding, Metal-to-Metal

Lincore® 410 .....	H-40
Lincore® 410NiMo .....	H-41
Lincore® 423L .....	H-42
Lincore® 423Cr .....	H-43
Lincore® 420 .....	H-44
Lincore® 414N .....	H-45
Lincore® 423N .....	H-45
Lincore® 96S .....	H-46
Lincore® 102W .....	H-47
Lincore® 102HC .....	H-48

## Flux-Cored (FCAW-G) Wire

### Build-Up

Lincore® BU-G .....	H-49
---------------------	------

### Metal-to-Metal

Lincore® 55-G .....	H-50
---------------------	------

## Flux-Cored (FCAW-S) Wire

### Build-Up

Lincore® BU .....	H-51
Lincore® 33 .....	H-52

### Metal-to-Metal

Lincore® 40-O .....	H-53
Lincore® 55 .....	H-54
Lincore® T & D .....	H-55

### Severe Impact

Lincore® M .....	H-56
Lincore® 15CrMn .....	H-57
Lincore® FROG MANG® .....	H-58
Lincore® Super Rail™ .....	H-59

## Abrasion Plus Impact

Lincore® 50 .....	H-60
-------------------	------

### Severe Abrasion

Lincore® 60-O .....	H-61
Lincore® Ultra K .....	H-62
Lincore® 65-O .....	H-63
Lincore® 70-O .....	H-64
Lincore® BCR-O .....	H-65
Lincore® BNB-O .....	H-66
Lincore® Gatorback-O .....	H-67
Lincore® Gatorback-S .....	H-68
Lincore® Ultra R .....	H-69
Lincore® TiCore .....	H-70
Weartech® SHS® 9800U .....	H-71
Weartech® SHS® 9700U .....	H-72
Weartech® SHS® 9192U .....	H-73
Weartech® SHS® 9500U .....	H-74

## Submerged Arc (SAW) Flux

### Hardfacing

Lincolnweld® A-96-S .....	H-75
Lincolnweld® H-535™ .....	H-75
Lincolnweld® H-560™ .....	H-76

### Neutral Flux

Lincolnweld® 801® .....	H-77
Lincolnweld® 802® .....	H-77

## Hardbanding Cored Wire

### Severe Abrasion

Weartech® Guardian® HB .....	H-78
Weartech® Guardian® CF .....	H-79

CONSUMABLES  
**HARDFACING**

*Wire Arc Spray*

**Severe Abrasion**

Weartech® SHS® 7570W.....	H-80
Weartech® SHS® 8000W.....	H-81
Weartech® SHS® 9172W.....	H-82

*Thermal Spray Powder*

**Severe Abrasion**

Weartech® SHS® 7574HV.....	H-83
Weartech® SHS® 8000HV.....	H-84
Weartech® SHS® 9172HV.....	H-85

*Plasma Transferred Arc Weld Powder (PTAW)*

**Severe Abrasion**

Weartech® SHS® 9290P.....	H-86
Weartech® SHS® 9700P.....	H-87



# WEARTECH® WT-1 SMAW

Cobalt ▪ AWS A5.13 ECoCr-C

## KEY FEATURES

- Cobalt, chrome, high tungsten
- Electrode excellent for abrasion and corrosion resistance
- Retains hardness at temperatures exceeding 1400°F (760°C)

## TYPICAL APPLICATIONS

- Wear Pads
- Mixer Rotors
- Pump Sleeves

## WELDING POSITIONS

All

## DIAMETERS / PACKAGING

Diameter in (mm)	10 lb (4.5 kg) Carton
3/32 (2.4)	E1010-240X350
1/8 (3.2)	E1010-320X350
5/32 (4.0)	E1010-400X350
3/16 (4.8)	E1010-480X350

## DEPOSIT COMPOSITION<sup>(1)</sup>

	%C	%Mn	%Si	%Cr	%Ni
Requirements - AWS A5.13 ECoCr-C	1.7-3.0	2.0 max	2.0 max	25-33	3.0 max
Typical Results <sup>(2)</sup>	2.1	0.6	0.6	28.1	2.4
	%Fe	%Mo	%W	%Co	Hardness, Rc
Requirements - AWS A5.13 ECoCr-C	5.0 max	1.0 max	11-14	Balance	Not Required
Typical Results <sup>(2)</sup>	4.1	0.1	12.3	50	52

## TYPICAL OPERATING PROCEDURES

Polarity	Current (Amps)	
	1/8 in (3.2 mm)	5/32 in (4.0 mm)
DC+	115-135	145-165

<sup>(1)</sup>Typical undiluted weld metal. <sup>(2)</sup>See test results disclaimer.

IMPORTANT: SPECIAL VENTILATION AND/OR EXHAUST REQUIRED

Fumes from the normal use of some welding products can contain significant quantities of components - such as chromium and manganese - which can lower the 5.0 mg/m<sup>3</sup> maximum exposure guideline for general welding fume.

BEFORE USE, READ AND UNDERSTAND THE SAFETY DATA SHEET (SDS) FOR THIS PRODUCT AND SPECIFIC INFORMATION PRINTED ON THE PRODUCT CONTAINER.

# WEARTECH® WT-6 SMAW

Cobalt ▪ AWS A5.13 ECoCr-A

## KEY FEATURES

- Cobalt, high chromium, tungsten electrode
- Excellent for corrosion resistance, wear and galling
- Most flexible and widely used of the cobalt alloys due to overall performance
- Retains hardness up to 930°F (500°C)

## TYPICAL APPLICATIONS

- Shear Blades
- Fluid Flow Valves
- Extrusion Screws
- Roll Bushings
- High Temperature
- Valve Bearing Surface

## WELDING POSITIONS

All

## DIAMETERS / PACKAGING

Diameter in (mm)	10 lb (4.5 kg) Carton
3/32 (2.4)	E1060-240X350
1/8 (3.2)	E1060-320X350
5/32 (4.0)	E1060-400X350
3/16 (4.8)	E1060-480X350

## DEPOSIT COMPOSITION<sup>(1)</sup>

	%C	%Mn	%Si	%Cr	%Ni
<b>Requirements</b> AWS A5.13 ECoCr-A	0.7-1.4	2.0 max	2.0 max	25-32	3.0 max
<b>Typical Results<sup>(2)</sup></b>	1.2	0.9	1.1	27.3	2.5
	%Fe	%Mo	%W	%Co	Hardness, Rc
<b>Requirements</b> AWS A5.13 ECoCr-A	5.0 max	1.0 max	3.0 -6.0	Balance	Not Required
<b>Typical Results<sup>(2)</sup></b>	3.3	0.1	4.60	58	41

## TYPICAL OPERATING PROCEDURES

Polarity	Current (Amps)		
	1/8 in (3.2 mm)	5/32 in (4.0 mm)	3/16 in (4.8 mm)
DC+	115-135	145-165	175-195

<sup>(1)</sup>Typical undiluted weld metal. <sup>(2)</sup>See test results disclaimer.

IMPORTANT: SPECIAL VENTILATION AND/OR EXHAUST REQUIRED

Fumes from the normal use of some welding products can contain significant quantities of components - such as chromium and manganese - which can lower the 5.0 mg/m<sup>3</sup> maximum exposure guideline for general welding fume.

BEFORE USE, READ AND UNDERSTAND THE SAFETY DATA SHEET (SDS) FOR THIS PRODUCT AND SPECIFIC INFORMATION PRINTED ON THE PRODUCT CONTAINER.

# WEARTECH® WT-12 SMAW

Cobalt ▪ AWS A5.13 ECoCr-B

## KEY FEATURES

- Cobalt, very high chromium, high carbon, high tungsten electrode
- Very resistant to wear, corrosion, and galling at high temperatures
- Intermediate alloy between WT-1 and WT-6
- Maintains hardness up to 1300°F (700°C)

## TYPICAL APPLICATIONS

- Chain Saw Bars
- Saw Teeth
- Extrusion Dies

## WELDING POSITIONS

All

## DIAMETERS / PACKAGING

Diameter in (mm)	10 lb (4.5 kg) Carton
3/32 (2.4)	E1120-240X350
1/8 (3.2)	E1120-320X350
5/32 (4.0)	E1120-400X350
3/16 (4.8)	E1120-480X350

## DEPOSIT COMPOSITION<sup>(1)</sup>

	%C	%Mn	%Si	%Cr	%Ni
<b>Requirements</b> AWS A5.13 ECoCr-B	1.0-1.7	2.0 max	2.0 max	25-32	3.0 max
<b>Typical Results<sup>(2)</sup></b>	1.5	0.9	1.1	28.7	2.6
	%Fe	%Mo	%W	%Co	Hardness, Rc
<b>Requirements</b> AWS A5.13 ECoCr-B	5.0 max	1.0 max	7.0 -9.5	Balance	Not Required
<b>Typical Results<sup>(2)</sup></b>	3.1	0.1	8.5	53	46

## TYPICAL OPERATING PROCEDURES

Polarity	Current (Amps) 1/8 in (3.2 mm)
DC+	115-135

<sup>(1)</sup>Typical undiluted weld metal. <sup>(2)</sup>See test results disclaimer.

IMPORTANT: SPECIAL VENTILATION AND/OR EXHAUST REQUIRED

Fumes from the normal use of some welding products can contain significant quantities of components - such as chromium and manganese - which can lower the 5.0 mg/m<sup>3</sup> maximum exposure guideline for general welding fume.

BEFORE USE, READ AND UNDERSTAND THE SAFETY DATA SHEET (SDS) FOR THIS PRODUCT AND SPECIFIC INFORMATION PRINTED ON THE PRODUCT CONTAINER.

# WEARTECH® WT-21 SMAW

Cobalt ▪ AWS A5.13 ECoCr-E

## KEY FEATURES

- Cobalt, high chromium, molybdenum electrode
- Excellent for corrosion resistance, galling, cavitation, and metal-to-metal wear resistance
- Not recommended for severe abrasion

## TYPICAL APPLICATIONS

- Steam Valves
- Hot Shears
- Chemical and Petrochemical Valves
- Cavation Repair
- Forging Dies

## WELDING POSITIONS

All

## DIAMETERS / PACKAGING

Diameter in (mm)	10 lb (4.5 kg) Carton
3/32 (2.4)	E1210-240X350
1/8 (3.2)	E1210-320X350
5/32 (4.0)	E1210-400X350
3/16 (4.8)	E1210-480X350

## DEPOSIT COMPOSITION<sup>(1)</sup>

	%C	%Mn	%Si	%Cr	%Ni
<b>Requirements</b> AWS A5.13 ECoCr-E	0.15-0.40	1.5 max	2.0 max	24-29	2.0 -4.0
<b>Typical Results<sup>(2)</sup></b>	0.23	0.8	0.8	27.7	2.8
	%Fe	%Mo	%W	%Co	Hardness, Rc
<b>Requirements</b> AWS A5.13 ECoCr-E	5.0 max	4.5-6.5	0.50 max	Balance	Not Required
<b>Typical Results<sup>(2)</sup></b>	2.4	5.5	0.05	59	28

## TYPICAL OPERATING PROCEDURES

Polarity	Current (Amps)		
	1/8 in (3.2 mm)	5/32 in (4.0 mm)	3/16 in (4.8 mm)
DC+	115-135	145-165	175-195

<sup>(1)</sup>Typical undiluted weld metal. <sup>(2)</sup>See test results disclaimer.

IMPORTANT: SPECIAL VENTILATION AND/OR EXHAUST REQUIRED

Fumes from the normal use of some welding products can contain significant quantities of components - such as chromium and manganese - which can lower the 5.0 mg/m<sup>3</sup> maximum exposure guideline for general welding fume.

BEFORE USE, READ AND UNDERSTAND THE SAFETY DATA SHEET (SDS) FOR THIS PRODUCT AND SPECIFIC INFORMATION PRINTED ON THE PRODUCT CONTAINER.

# WEARSHIELD® BU

## Build-Up

### KEY FEATURES

- Build-up with moderate hardness to resist shock and metal-to-metal wear, as in rolling and sliding
- Can be used as underbase for other hardfacing deposits or as final overlay on parts to be machined or forged
- Unlimited layers with proper preheat, interpass temperatures and procedures
- Use on mild and low alloy steels

### TYPICAL APPLICATIONS

#### For Build-Up

- Shovel and bucket lips
- Pump impellers and housings
- Pulverizer plows
- Mill hammers

#### For Hardfacing

- Trunnions, tractor rolls, cranes and gears

### WELDING POSITIONS

Flat & Horizontal

### DIAMETERS / PACKAGING

Diameter in (mm)	Length in (mm)	10 lb (4.5 kg) Carton 40 lb (18.1 kg) Master Carton
5/32 (4.0)	14 (350)	ED021991
3/16 (4.8)	14 (350)	ED021993

### MECHANICAL PROPERTIES<sup>(1)</sup>

Rockwell Hardness (R <sub>c</sub> )		
1 Layer	2 Layers	3 Layers
15-20	18-23	23-28

### DEPOSIT COMPOSITION<sup>(1)</sup>

	%C	%Mn	%Si	%Cr	%S	%P
2 or more layers	0.14	1.15	0.60	1.40	0.025	0.015

### TYPICAL OPERATING PROCEDURES

Polarity <sup>(2)</sup>	Current (Amps)	
	5/32 in (4.0 mm)	3/16 in (4.8 mm)
DC+	145-210	180-280
AC	155-225	200-290

<sup>(1)</sup>Composition and properties depend upon dilution. Single layer deposit properties depend upon base metal and/or build-up material. <sup>(2)</sup>Preferred polarity is listed first.

NOTE: Using a short arc with a slight weave motion, deposit beads about 1/2 in - 3/4 in (13-19 mm) wide with the 5/32 in and 3/16 in (4.0-4.8 mm) electrode diameters, and about 1 in (25 mm) wide with the 1/4 in (6.4 mm) diameter. However, on edges and corners, fast-moving stringer beads or very narrow weaved beads are usually preferred. The exact width and thickness of the bead will depend on the mass of the piece being welded.

Work-hardened base or weld metal should be removed before applying Wearshield® BU, since such areas are more prone to embrittlement and possible cracking. The part should be preheated to at least 21°C (70°F). Preheating above 40°C (100°F) is usually not required. Preheating depends largely on the base metal composition. On large, complex, or restrained parts, a preheat of 150° - 260°C (300° - 500°F) may be necessary.

#### IMPORTANT: SPECIAL VENTILATION AND/OR EXHAUST REQUIRED

Fumes from the normal use of some welding products can contain significant quantities of components - such as chromium and manganese - which can lower the 5.0 mg/m<sup>3</sup> maximum exposure guideline for general welding fume.

BEFORE USE, READ AND UNDERSTAND THE SAFETY DATA SHEET (SDS) FOR THIS PRODUCT AND SPECIFIC INFORMATION PRINTED ON THE PRODUCT CONTAINER.

# WEARSHIELD® MI

Metal-to-Metal

## KEY FEATURES

- Provides a martensitic deposit with considerable retained austenite
- General purpose electrode, a good compromise for metal-to-metal wear, moderate impact and mild abrasion
- Can be used on carbon and low alloy steel parts
- Deposits tend to cross check crack and are usually best limited to two layers

## WELDING POSITIONS

All, except vertical down

## TYPICAL APPLICATIONS

- Boom heels
- Conveyor screws
- Dipper lips
- Tractor grousers
- Ditcher teeth
- Lumber equipment
- Hammer mills

## DIAMETERS / PACKAGING

Diameter in (mm)	Length in (mm)	10 lb (4.5 kg) Carton 40 lb (18.1 kg) Master Carton
1/8 (3.2)	14 (350)	ED022003
5/32 (4.0)	14 (350)	ED022005
3/16 (4.8)	14 (350)	ED022007

## MECHANICAL PROPERTIES<sup>(1)</sup>

Rockwell Hardness (R <sub>c</sub> )	
1 Layer	2 or More Layers
50	54

## DEPOSIT COMPOSITION<sup>(1)</sup>

On Carbon Steel	%C	%Mn	%Si	%Cr	%Mo
2 or More Layers	0.9	0.4	0.4	9.5	0.6

## TYPICAL OPERATING PROCEDURES

Polarity <sup>(2)</sup>	Current (Amps)		
	1/8 in (3.2 mm)	5/32 in (4.0 mm)	3/16 in (4.8 mm)
DC+	70-120	110-150	150-200
AC	70-120	110-150	150-200

<sup>(1)</sup>Composition and properties depend upon dilution. Single layer deposit properties depend upon base metal and/or build-up material. <sup>(2)</sup>Preferred polarity is listed first.

NOTE: In welding with Wearshield® MI, a short arc or a long arc may be used. The short arc will give greater build-up with each bead. The long arc is ideal for depositing thin layers, though alloy recovery may be reduced. In depositing Wearshield® MI, preheat and interpass temperatures of 200°C (400°F) minimum are helpful, as well as limiting deposit to two layers, to reduce cracking and avoid chipping and fragmentation. Weld deposit cannot be cut with oxy-fuel process. Plasma arc and air-carbon arc processes can cut or gouge the weld deposit successfully. Grinding is usually best if the deposit needs to be shaped.

### IMPORTANT: SPECIAL VENTILATION AND/OR EXHAUST REQUIRED

Fumes from the normal use of some welding products can contain significant quantities of components - such as chromium and manganese - which can lower the 5.0 mg/m<sup>3</sup> maximum exposure guideline for general welding fume.

BEFORE USE, READ AND UNDERSTAND THE SAFETY DATA SHEET (SDS) FOR THIS PRODUCT AND SPECIFIC INFORMATION PRINTED ON THE PRODUCT CONTAINER.

# WEARSHIELD® MANGJET®

Metal-to-Metal

## KEY FEATURES

- For building up austenitic manganese steel and cladding carbon steels
- Produces an austenitic manganese deposit that will work harden in service
- Unlimited layers with proper preheat, interpass temperatures and procedures

## TYPICAL APPLICATIONS

- Dragline pins
- Dipper teeth
- Crusher screens and rolls
- Chain hooks
- Hammers
- Bucket teeth

## WELDING POSITIONS

All, except vertical down

## DIAMETERS / PACKAGING

Diameter in (mm)	Length in (mm)	50 lb (22.7kg) Carton
5/32 (4.0)	14 (350)	ED021976
3/16 (4.8)	14 (350)	ED021978
1/4 (6.4)	18 (450)	ED021979

## MECHANICAL PROPERTIES<sup>(1)</sup>

As-Welded (2 Layers)		Rockwell Hardness (R <sub>c</sub> )	Work Hardened (2 Layers)	
18			47	

## DEPOSIT COMPOSITION<sup>(1)</sup>

On Carbon Steel	%C	%Mn	%Si	%Mo	%S
<b>2 or More Layers</b>	0.65	14.5	0.14	1.15	0.01

## TYPICAL OPERATING PROCEDURES

Polarity <sup>(2)</sup>	Current (Amps)		
	5/32 in (4.0 mm)	3/16 in (4.8 mm)	1/4 in (6.4 mm)
DC+	120-180	160-260	200-350
AC	125-210	175-275	225-375

<sup>(1)</sup> Composition and properties depend upon dilution. Single layer deposit properties depend upon base metal and/or build-up material. <sup>(2)</sup> Preferred polarity is listed first.

*NOTE: Work-hardened base metal or previously deposited weld metal should be ground off before applying a new deposit, since such areas are more prone to embrittlement and possible cracking. Areas that cannot be easily indented with a center punch should be removed.*

*When joining manganese steel, the joint should be prepared for 100% penetration. A cutting torch may be used to bevel the edges of the plate which can crack if care is not taken to prevent overheating the base metal.*

*Preheat is not necessary unless work is below room temperature, or if the part is unusually massive or complex in design. In such cases, heating the piece to about room temperature, or 38° - 66°C (100° - 150°F) at the most, should be sufficient.*

*As with all austenitic manganese welding products, interpass temperatures should be limited to 260°C (500°F) maximum. A stringer bead, or at most, a slight weave is recommended to limit heat build-up. Excessive heat build-up causes manganese carbide precipitation which damages the toughness of austenitic manganese.*

### IMPORTANT: SPECIAL VENTILATION AND/OR EXHAUST REQUIRED

Fumes from the normal use of some welding products can contain significant quantities of components - such as chromium and manganese - which can lower the 5.0 mg/m<sup>3</sup> maximum exposure guideline for general welding fume.

BEFORE USE, READ AND UNDERSTAND THE SAFETY DATA SHEET (SDS) FOR THIS PRODUCT AND SPECIFIC INFORMATION PRINTED ON THE PRODUCT CONTAINER.

# WEARSHIELD® 15CRMN

## Severe Impact

### KEY FEATURES

- Provides a premium austenitic chromium manganese deposit
- Resists severe impact or gouging even in a single layer over carbon steel
- Used to join Hadfield manganese steel to itself or to carbon steel
- Excellent for build-up on carbon steel prior to chromium carbide hardfacing deposit with an electrode such as Wearshield® 60
- Unlimited layers

### TYPICAL APPLICATIONS

- Crusher hammers
- Rebuilding and joining of austenitic manganese plates and parts
- Earth moving equipment

### WELDING POSITIONS

All, except vertical down

### DIAMETERS / PACKAGING

Diameter in (mm)	Length in (mm)	10 lb (4.5 kg) Carton 40 lb (18.1 kg) Master Carton
1/8 (3.2)	14 (350)	ED021980
5/32 (4.0)	14 (350)	ED021982
3/16 (4.8)	14 (350)	ED021984

### MECHANICAL PROPERTIES<sup>(1)</sup>

Rockwell Hardness (R <sub>c</sub> ) (Single or Multiple Layers)	
As-Welded	Work Hardened
18-24	40-50

### DEPOSIT COMPOSITION<sup>(1)</sup>

On Carbon Steel	%C	%Mn	%Si	%Cr
<b>2 or More Layers</b>	0.35	14.0	0.6	15.0

### TYPICAL OPERATING PROCEDURES

Polarity <sup>(2)</sup>	Current (Amps)		
	1/8 in (3.2 mm)	5/32 in (4.0 mm)	3/16 in (4.8 mm)
DC+	140-160	190-210	220-250
AC	140-160	190-210	220-250

<sup>(1)</sup> Composition and properties depend upon dilution. Single layer deposit properties depend upon base metal and/or build-up material. <sup>(2)</sup> Preferred polarity is listed first.

*NOTE: In welding with Wearshield® 15CrMn, a short arc is preferred. The electrode can easily be dragged without fear of snuffing out the arc. For situations involving severe impact and abrasion, a build-up of Wearshield® 15CrMn capped with a single layer of Wearshield® 60 or Lincore® 60-0 can provide excellent service. In depositing Wearshield® 15CrMn on itself or on austenitic manganese steel, preheat is generally unnecessary unless the metal is below 16°C (60°F). However, highly hardenable carbon or low alloy steel base metals may require preheat in the 150°C - 204°C (300° - 400°F) range to avoid heat affected zone cracking.*

*Wearshield® 15CrMn deposits work harden rapidly, which makes them difficult to machine. Best results are obtained with carbide or ceramic tool bits. Avoid superficial cuts, and maintain a sharp cutting edge. Grinding can also be done successfully. Because of the high chromium content, Wearshield® 15CrMn cannot be cut with oxy-fuel processes. Plasma arc and air carbon arc processes can cut or gouge the weld deposit successfully. Limit interpass temperature to 260°C (500°F) to avoid embrittlement.*

#### IMPORTANT: SPECIAL VENTILATION AND/OR EXHAUST REQUIRED

Fumes from the normal use of some welding products can contain significant quantities of components - such as chromium and manganese - which can lower the 5.0 mg/m<sup>3</sup> maximum exposure guideline for general welding fume.

BEFORE USE, READ AND UNDERSTAND THE SAFETY DATA SHEET (SDS) FOR THIS PRODUCT AND SPECIFIC INFORMATION PRINTED ON THE PRODUCT CONTAINER.



# WEARSHIELD® FROG MANG®

## Severe Impact

### KEY FEATURES

- Designed specifically for building up manganese frogs and manganese crossing diamonds in the railroad industry
- Provides a high strength, high alloy austenitic manganese deposit to handle the increased loading of railroad cars
- Unlimited layers with proper preheat, interpass temperatures and procedures
- Resistant to deformation and the resultant metal flow

### TYPICAL APPLICATIONS

- Manganese crossing diamonds
- Manganese railroad frogs

### WELDING POSITIONS

All, except vertical down

### DIAMETERS / PACKAGING

Diameter in (mm)	Length in (mm)	10 lb (4.5 kg) Easy Open Can 30 lb (13.6 kg) Master Carton	12 lb (5.4 kg) Easy Open Can 36 lb (16.3 kg) Master Carton
5/32 (4.0)	14 (350)	ED033134	ED033133
3/16 (4.8)	14 (350)	ED033135	
1/4 (6.4)	18 (450)		

### MECHANICAL PROPERTIES<sup>(1)</sup>

Rockwell Hardness (R <sub>c</sub> )	
As-Welded	Work Hardened
20 - 30	40 - 50

### DEPOSIT COMPOSITION<sup>(1)</sup>

On Carbon Steel	%C	%Mn	%Si	%Cr
6 Layers	1.20	21.0	0.4	5.3

### TYPICAL OPERATING PROCEDURES

Polarity <sup>(2)</sup>	Current (Amps)		
	5/32 in (4.0 mm)	3/16 in (4.8 mm)	1/4 in (6.4 mm)
DC+	140 - 175	175 - 215	235 - 280
AC	150 - 180	185 - 215	235 - 280

<sup>(1)</sup>Composition and properties depend upon dilution. Single layer deposit properties depend upon base metal and/or build-up material.<sup>(2)</sup>Preferred polarity is listed first.

**NOTE: Weld Preparation** Remove all damaged and foreign material by air-carbon arc gouging or grinding. Make sure all defective metal is removed. In the event hairline cracks remain at flangeway depth, use a 3.2 mm (1/8 in) E308 stainless electrode, such as Blue Max® or Red Baron® 308L AC-DC to tie up these cracks. This will avoid hot cracking during the build-up process. Apply only thin layers and do not build-up with E308 stainless. This is for emergency situations where no other alternative is available to repair flangeway cracks.

Use DC+ to avoid excessive spatter. When possible, weld at alternate locations (skip weld) to avoid overheating of metal in a localized area. Do not exceed interpass temperature of 260 °C (500 °F). Use a temperature marker 13 mm (1/2 in) from the welded area at frequent intervals to ensure that interpass temperature does not exceed 260 °C (500 °F).

Use a short arc and a stringer bead width of 10 to 13 mm (3/8 to 1/2 in).

Finish the casting by grinding to a safe contour. Leave enough weld metal during the welding process to allow a level and even contour after grinding. Make sure all areas are finished and the casting has no further visible defects. Check with straight edge so that the casting is free of low spots. As with all austenitic manganese welding products, interpass temperatures should be limited to 260 °C (500 °F) maximum. A stringer bead, or at most, a slight weave is recommended to limit heat build-up. Excessive heat build-up causes manganese carbide precipitation which damages the toughness of austenitic manganese.

#### IMPORTANT: SPECIAL VENTILATION AND/OR EXHAUST REQUIRED

Fumes from the normal use of some welding products can contain significant quantities of components - such as chromium and manganese - which can lower the 5.0 mg/m<sup>3</sup> maximum exposure guideline for general welding fume.

BEFORE USE, READ AND UNDERSTAND THE SAFETY DATA SHEET (SDS) FOR THIS PRODUCT AND SPECIFIC INFORMATION PRINTED ON THE PRODUCT CONTAINER.

# WEARSHIELD® SUPER RAIL™

Severe Impact

## KEY FEATURES

- Reduce carbon steel repairs by 50%
- Low material distortion on impact
- Work hardens faster without cracking

## TYPICAL APPLICATIONS

- Rail Ends/ Points
- Rail Crossing Points

## WELDING POSITIONS

Flat and Horizontal

## DIAMETERS / PACKAGING

Diameter in (mm)	Length in (mm)	10 lb (4.5 kg) Easy Open Can 30 lb (13.6 kg) Master Carton
3/16 (4.8)	14 (350)	ED035352

## DEPOSIT COMPOSITION<sup>(1)</sup>

On Carbon Steel	%C	%Mn	%Si	%Cr	%Mo	%Ni
4 Layers	<1	<5	<2	<5	<1	<3

## TYPICAL OPERATING PROCEDURES

Polarity <sup>(2)</sup>	Current (Amps) 3/16 in (4.8 mm)
DC+	175 - 215
AC	185 - 215

<sup>(1)</sup>Composition and properties depend upon dilution. Single layer deposit properties depend upon base metal and/or build-up material. <sup>(2)</sup>Preferred polarity is listed first.

IMPORTANT: SPECIAL VENTILATION AND/OR EXHAUST REQUIRED

Fumes from the normal use of some welding products can contain significant quantities of components - such as chromium and manganese - which can lower the 5.0 mg/m<sup>3</sup> maximum exposure guideline for general welding fume.

BEFORE USE, READ AND UNDERSTAND THE SAFETY DATA SHEET (SDS) FOR THIS PRODUCT AND SPECIFIC INFORMATION PRINTED ON THE PRODUCT CONTAINER.

# WEARSHIELD® ABR

## Abrasion and Impact

### KEY FEATURES

- Provides good resistance to abrasion, impact and some metal-to-metal wear
- Good hot forging properties
- Use on carbon, stainless and manganese steels
- Deposits limited to two layers
- Can be forged readily without affecting its mechanical properties

### TYPICAL APPLICATIONS

- Crusher hammers
- Dozer blades
- Dipper teeth and lips
- Coal mining cutters
- Truck chain and gears

### WELDING POSITIONS

All

### DIAMETERS / PACKAGING

Diameter in (mm)	Length in (mm)	10 lb (4.5 kg) Carton 40 lb (18.1 kg) Carton
1/8 (3.2)	14 (350)	ED021996
5/32 (4.0)	14 (350)	ED021998
3/16 (4.8)	14 (350)	ED022000

### MECHANICAL PROPERTIES<sup>(1)</sup>

Rockwell Hardness (R <sub>c</sub> )	
1 Layer	2 Layers
24-53	28-53

### DEPOSIT COMPOSITION<sup>(1)</sup>

On Carbon Steel	%C	%Mn	%Si	%Cr	%Mo
2 Layers	2.1	1.1	0.75	6.5	0.40

### TYPICAL OPERATING PROCEDURES

Polarity <sup>(2)</sup>	Current (Amps)		
	1/8 in (3.2 mm)	5/32 in (4.0 mm)	3/16 in (4.8 mm)
DC+	40-150	75-200	110-250
AC	50-165	80-220	120-275

<sup>(1)</sup>Composition and properties depend upon dilution. Single layer deposit properties depend upon base metal and/or build-up material. <sup>(2)</sup>Preferred polarity is listed first.

NOTE: Wearshield® ABR can be forged readily without affecting its mechanical properties. As deposited, Wearshield® ABR weld metal is not machinable, although the deposit can be shaped by grinding. To obtain a deposit that is machinable with carbide tools, heat to about 749°C (1380°F) and hold for one hour per inch of thickness. Air cool to room temperature.

For maximum machinability, heat to 870° - 900°C (1600° - 1650°F) and hold for one hour per inch of thickness. Furnace cool to 650°C (1200°F) at a rate not exceeding 10°C (50°F) per hour, and air or furnace cool to room temperature. Variation in welding procedures will have little effect on abrasion resistance.

The abrasion resistance can be restored by heating to about 790°C (1450°F), quenching and tempering at 200°C (400°F).

#### IMPORTANT: SPECIAL VENTILATION AND/OR EXHAUST REQUIRED

Fumes from the normal use of some welding products can contain significant quantities of components - such as chromium and manganese - which can lower the 5.0 mg/m<sup>3</sup> maximum exposure guideline for general welding fume.

BEFORE USE, READ AND UNDERSTAND THE SAFETY DATA SHEET (SDS) FOR THIS PRODUCT AND SPECIFIC INFORMATION PRINTED ON THE PRODUCT CONTAINER.

# WEARSHIELD® 44

## Abrasion and Impact

### KEY FEATURES

- Moderate hardness to resist abrasion with impact up to 600°C (1100°F)
- Higher alloy results in improved spalling resistance than Wearshield® ABR
- Can be used on carbon steels, low alloy steels, cast irons, austenitic manganese steels and austenitic stainless steels

### TYPICAL APPLICATIONS

- Buckets
- Chain links
- Rolling mill guides
- Pulleys
- Ingot tongs

### WELDING POSITIONS

Flat & Horizontal

### DIAMETERS / PACKAGING

Diameter in (mm)	Length in (mm)	10 lb (4.5 kg) Carton 40 lb (18.1 kg) Master Carton
1/8 (3.2)	14 (350)	ED024940
5/32 (4.0)	14 (350)	ED024941

### MECHANICAL PROPERTIES<sup>(1)</sup>

Rockwell Hardness (R <sub>c</sub> )		
1 Layer		4 Layers
42		48

### DEPOSIT COMPOSITION<sup>(1)</sup>

On Carbon Steel	%C	%Mn	%Si	%Cr	%Mo
1 Layer	1.56	0.17	0.77	19.5	1.92
2 Layers	1.96	0.16	0.87	24.2	2.48
4 Layers	2.21	0.18	0.93	27.1	2.86

### TYPICAL OPERATING PROCEDURES

Polarity <sup>(2)</sup>	Current (Amps)	
	1/8 in (3.2 mm)	5/32 in (4.0 mm)
DC+	120 - 160	150 - 220
AC	130 - 160	180 - 220

<sup>(1)</sup>Composition and properties depend upon dilution. Single layer deposit properties depend upon base metal and/or build-up material. <sup>(2)</sup>Preferred polarity is listed first.

NOTE: Wearshield® 44 electrodes form a deep cup, which permits light dragging of the electrode during welding. The arc is steady with little spatter in the DC+ mode. During AC welding, the arc is also steady, but the usable current range is reduced, and the melt-off rates are reduced at any current. Since the amount of dilution does not affect the microstructure, the impact properties and abrasion resistance will be similar from the first layer to the last.

On cast irons, Wearshield® 44 deposits usually check crack. These check cracks should be closely spaced to prevent spalling. This is obtained by using stringer beads.

IMPORTANT: SPECIAL VENTILATION AND/OR EXHAUST REQUIRED
Fumes from the normal use of some welding products can contain significant quantities of components - such as chromium and manganese - which can lower the 5.0 mg/m <sup>3</sup> maximum exposure guideline for general welding fume.
BEFORE USE, READ AND UNDERSTAND THE SAFETY DATA SHEET (SDS) FOR THIS PRODUCT AND SPECIFIC INFORMATION PRINTED ON THE PRODUCT CONTAINER.

# WEARSHIELD® ME

## Metal-to-Earth Wear

### KEY FEATURES

- High alloy produces chrome carbides and austenite
- Provides greater abrasion resistance than Wearshield® ABR or Wearshield® 44
- Low dilution weld metal provides eutectic mix of chromium carbides and austenite, with limited primary carbides.
- To be used on carbon and low alloy, austenitic manganese and austenitic stainless steels

### TYPICAL APPLICATIONS

- Muller tires
- Augers
- Bucket teeth
- Dozer blades

### WELDING POSITIONS

Flat & Horizontal

### DIAMETERS / PACKAGING

Diameter in (mm)	Length in (mm)	10 lb (4.5 kg) Carton 40 lb (18.1 kg) Master Carton
1/8 (3.2)	14 (350)	ED023323
5/32 (4.0)	14 (350)	ED023324
3/16 (4.8)	14 (350)	ED023325

### MECHANICAL PROPERTIES<sup>(1)</sup>

Rockwell Hardness (R <sub>c</sub> )	
1 Layer	3 Layers
49	55

### DEPOSIT COMPOSITION<sup>(1)</sup>

On Carbon Steel	%C	%Mn	%Si	%Cr
<b>1 Layer</b>	2.5	0.17	0.8	27.0
<b>2 Layers</b>	3.0	0.17	1.0	30.5
<b>3 Layers</b>	3.3	0.16	1.1	32.6

### TYPICAL OPERATING PROCEDURES

Polarity <sup>(2)</sup>	Current (Amps)		
	1/8 in (3.2 mm)	5/32 in (4.0 mm)	3/16 in (4.8 mm)
DC+	125 - 175	175 - 250	220 - 330
AC	130 - 170	180 - 220	230 - 270

<sup>(1)</sup> Composition and properties depend upon dilution. Single layer deposit properties depend upon base metal and/or build-up material. <sup>(2)</sup> Preferred polarity is listed first.

NOTE: Wearshield® ME is a heavily coated electrode which forms a deep cup that permits light dragging of the stick during welding. Deposits generally check crack except for single layers on thin base metal. Stringer beads produce a consistent crack spacing of about 13-25 mm (1/2-1 in).

Wide weaves may produce very widely spaced check cracks which can lead to deposit spalling in multiple layers. Weaving is not recommended. For maximum spalling resistance on carbon and low alloy steels, especially in multiple layers, apply a butter layer of Wearshield® 15CrMn, Lincore® 15CrMn or an austenitic stainless steel electrode such as Excalibur (R) 309/309L AC-DC, before applying Wearshield® ME.

#### IMPORTANT: SPECIAL VENTILATION AND/OR EXHAUST REQUIRED

Fumes from the normal use of some welding products can contain significant quantities of components - such as chromium and manganese - which can lower the 5.0 mg/m<sup>3</sup> maximum exposure guideline for general welding fume.

BEFORE USE, READ AND UNDERSTAND THE SAFETY DATA SHEET (SDS) FOR THIS PRODUCT AND SPECIFIC INFORMATION PRINTED ON THE PRODUCT CONTAINER.

# WEARSHIELD® 60

## Severe Abrasion

### KEY FEATURES

- Designed to resist severe abrasion
- It exhibits higher alloy and higher abrasion resistance than Wearshield® ABR, Wearshield® 44 or Wearshield® ME
- Can be used on carbon, low alloy, stainless, and manganese steels
- Deposits consist of primary carbides in a matrix of austenite-carbide eutectic
- Deposits should be limited to two layers

### TYPICAL APPLICATIONS

- Conveyor screws
- Grader blades
- Crusher rolls, plates and jaws
- Sleeves
- Brick and coke machinery

### WELDING POSITIONS

Flat & Horizontal

### DIAMETERS / PACKAGING

Diameter in (mm)	Length in (mm)	10 lb (4.5 kg) Carton 40 lb (18.1 kg) Master Carton
1/8 (3.2)	14 (350)	ED022010
5/32 (4.0)	14 (350)	ED022011
3/16 (4.8)	14 (350)	ED022012

### MECHANICAL PROPERTIES<sup>(1)</sup>

Rockwell Hardness (R <sub>c</sub> )	
1 Layer	2 Layers
57 - 60	60 - 62

### DEPOSIT COMPOSITION<sup>(1)</sup>

On Carbon Steel	%C	%Mn	%Si	%Cr	%Mo	%V
2 Layers	5.0	0.80	1.0	23.0	2.3	0.6

### TYPICAL OPERATING PROCEDURES

Polarity <sup>(2)</sup>	Current (Amps)		
	1/8 in (3.2 mm)	5/32 in (4.0 mm)	3/16 in (4.8 mm)
DC+	100 - 140	130 - 180	210 - 250
AC	110 - 150	140 - 200	230 - 270

<sup>(1)</sup>Composition and properties depend upon dilution. Single layer deposit properties depend upon base metal and/or build-up material. <sup>(2)</sup>Preferred polarity is listed first.

**NOTE:** The deposit is not machinable or forgeable. Cooling rate does not significantly influence abrasion resistance. Deposit will usually cross check.

If more than two-layer build-up is required, use Wearshield® 15CrMn (preferred), Wearshield® BU or Wearshield® BU30 for the preliminary layer or layers under Wearshield® 60. On manganese steel, use Wearshield® Mangjet® or Wearshield® 15CrMn as build-up. Preheat is not generally necessary except to be sure that work is in room temperature range 25° - 45°C (75° - 100°F). However, preheat of 120° - 200°C (250° - 400°F) may be necessary to prevent heat affected zone cracking on high carbon steel or low alloy steel base metals. If more than two layers must be used, or if cross checks must be eliminated, preheat to 650°C (1200°F).

Prolonged or repeated heating of manganese steel base metal over 260°C (500°F) can cause embrittlement and spalling. Avoid base metal embrittlement by:

- Limiting the temperature 260°C (500°F) at distances of 13 mm (1/2 in) away from the weld.
- Minimizing the time at elevated temperatures.

The correct welding technique is a vertical electrode with a 3.2 - 4.8 mm (1/8 - 3/16 in) arc length. The large ball on the end of the electrode should never touch the puddle. This technique will give a smooth transfer, low spatter and smooth bead.

#### IMPORTANT: SPECIAL VENTILATION AND/OR EXHAUST REQUIRED

Fumes from the normal use of some welding products can contain significant quantities of components - such as chromium and manganese - which can lower the 5.0 mg/m<sup>3</sup> maximum exposure guideline for general welding fume.

BEFORE USE, READ AND UNDERSTAND THE SAFETY DATA SHEET (SDS) FOR THIS PRODUCT AND SPECIFIC INFORMATION PRINTED ON THE PRODUCT CONTAINER.

# WEARTECH® SHS® 9700E

Severe Abrasion

## KEY FEATURES

- Lower cost while maintaining a near nanoscale (submicron) microstructure
- Provides exceptional wear resistance lasting significantly longer than most chrome carbide and complex carbide alloys
- Maintains high hardness after exposure to elevated temperatures
- Limited to 2 layers max

## TYPICAL APPLICATIONS

- Wearplate
- Crusher rolls
- Ore Chutes
- Screw augers

## DIAMETERS / PACKAGING

Diameter in (mm)	10 lb (4.5 kg) Carton
5/32 (4.0)	E9700-400X350

## MECHANICAL PROPERTIES<sup>(1)</sup>

Rockwell Hardness (R <sub>c</sub> )	Wear Resistance
67-70	ASTM G65-04 Procedure A 0.13 g mass loss

## DEPOSIT COMPOSITION<sup>(1)</sup>

%Fe	%C	%Cr	%B	%Nb	%Al	%Mn	%Si
Balance	<3	<18	<6	<10	<5	<2	<2

## TYPICAL OPERATING PROCEDURES

Diameter, Polarity in (mm)	Current (Amps)
5/32 in (4.0), DC+	150-175

<sup>(1)</sup>Limited to two layers

IMPORTANT: SPECIAL VENTILATION AND/OR EXHAUST REQUIRED

Fumes from the normal use of some welding products can contain significant quantities of components - such as chromium and manganese - which can lower the 5.0 mg/m<sup>3</sup> maximum exposure guideline for general welding fume.

BEFORE USE, READ AND UNDERSTAND THE SAFETY DATA SHEET (SDS) FOR THIS PRODUCT AND SPECIFIC INFORMATION PRINTED ON THE PRODUCT CONTAINER.

# BLUE MAX<sup>®</sup> 2100

Maintenance and Repair

## KEY FEATURES

- High resistance to cracking
- High strength
- Designed for joining difficult to weld steel

## TYPICAL APPLICATIONS

- High carbon, low alloy, high strength, manganese steels
- Base for hardfacing or stainless steel cladding

## WELDING POSITIONS

All, except vertical down

## DIAMETERS / PACKAGING

Diameter mm (in)	Length in (mm)	10 lb (4.5 kg) Easy Open Can
2.5 (3/32)	14 (350)	ED032298
3.2 (1/8)	14 (350)	ED032299

## MECHANICAL PROPERTIES<sup>(1)</sup>

	Yield Strength <sup>(2)</sup> MPa (ksi)	Tensile Strength MPa (ksi)	Elongation %	Ferrite Number
Typical Results <sup>(3)</sup>	670 (97)	805 (117)	22	> 50

## TYPICAL OPERATING PROCEDURES

Polarity <sup>(4)</sup>	Current (Amps)	
	2.4 mm (3/32 in)	3.2 mm (1/8 in)
DC+	40 - 80	75 - 110
AC	40 - 80	75 - 110

<sup>(1)</sup>Composition and properties depend upon dilution. Single layer deposit properties depend upon base metal and/or build-up material.

<sup>(2)</sup>Measured with 0.2% offset <sup>(3)</sup>See test results disclaimer <sup>(4)</sup>Preferred polarity is listed first.

IMPORTANT: SPECIAL VENTILATION AND/OR EXHAUST REQUIRED

Fumes from the normal use of some welding products can contain significant quantities of components - such as chromium and manganese - which can lower the 5.0 mg/m<sup>3</sup> maximum exposure guideline for general welding fume.

BEFORE USE, READ AND UNDERSTAND THE SAFETY DATA SHEET (SDS) FOR THIS PRODUCT AND SPECIFIC INFORMATION PRINTED ON THE PRODUCT CONTAINER.



# WEARTECH® WT-1 TIG

Cobalt ▪ AWS A5.21 ERCoCr-C

## KEY FEATURES

- Cobalt, chrome, high tungsten
- Electrode excellent for abrasion and corrosion resistance
- Retains hardness at temperatures exceeding 1400°F (760°C)

## TYPICAL APPLICATIONS

- Wear Pads
- Mixer Rotors
- Pump Sleeves

## WELDING POSITIONS

All

## WELDING PROCESSES

- Gas Tungsten Arc Welding
- Oxyfuel Welding

## DIAMETERS / PACKAGING

Diameter in (mm)	10 lb (4.5 kg) Carton
3/32 (2.4)	B1010-240X915
1/8 (3.2)	B1010-320X915
5/32 (4.0)	B1010-400X915
3/16 (4.8)	B1010-480X915
1/4 (6.4)	B1010-640X915
5/16 (7.9)	B1010-800X915

## WIRE COMPOSITION

	%C	%Mn	%Si	%Cr	%Ni
<b>Requirements</b> AWS A5.21 ERCoCr-C	2.0-3.0	1.0 max	2.0 max	26-33	3.0 max
<b>Typical Results<sup>(2)</sup></b>	2.2	0.1	1.0	29.5	2.4
	%Fe	%Mo	%W	%Co	Hardness, Rc
<b>Requirements</b> AWS A5.21 ERCoCr-C	3.0 max	1.0 max	11-14	Balance	Not Required
<b>Typical Results<sup>(2)</sup></b>	2.5	0.1	12.4	50	52

## TYPICAL OPERATING PROCEDURES

Polarity	Current (Amps) 1/8 in (3.2 mm)
DC-	115-135

IMPORTANT: SPECIAL VENTILATION AND/OR EXHAUST REQUIRED

Fumes from the normal use of some welding products can contain significant quantities of components - such as chromium and manganese - which can lower the 5.0 mg/m<sup>3</sup> maximum exposure guideline for general welding fume.

BEFORE USE, READ AND UNDERSTAND THE SAFETY DATA SHEET (SDS) FOR THIS PRODUCT AND SPECIFIC INFORMATION PRINTED ON THE PRODUCT CONTAINER.

# WEARTECH® WT-6 TIG

Cobalt ▪ AWS A5.21 ERCoCr-A

## KEY FEATURES

- Cobalt, high chromium, tungsten electrode
- Excellent for corrosion resistance, wear and galling
- Most flexible and widely used of the cobalt alloys due to overall performance
- Retains hardness up to 930°F (500°C)

## WELDING POSITIONS

All

## TYPICAL APPLICATIONS

- Shear Blades
- Fluid Flow Valves
- Extrusion Screws
- Roll Bushings
- High Temperature
- Valve Bearing Surface

## WELDING PROCESSES

- Gas Tungsten Arc Welding
- Oxyfuel Welding

## DIAMETERS / PACKAGING

Diameter in (mm)	10 lb (4.5 kg) Carton
3/32 (2.4)	B1060-240X915
1/8 (3.2)	B1060-320X915
5/32 (4.0)	B1060-400X915
3/16 (4.8)	B1060-480X915
1/4 (6.4)	B1060-640X915
5/16 (7.9)	B1060-800X915

## WIRE COMPOSITION

	%C	%Mn	%Si	%Cr	%Ni
<b>Requirements</b> AWS A5.21 ERCoCr-A	0.9-1.4	1.0 max	2.0 max	26-32	3.0 max
<b>Typical Results<sup>(2)</sup></b>	1.1	0.1	1.3	28.2	2.5
	%Fe	%Mo	%W	%Co	Hardness, Rc
<b>Requirements</b> AWS A5.21 ERCoCr-A	3.0 max	1.0 max	3.0-6.0	Balance	Not Required
<b>Typical Results<sup>(2)</sup></b>	2.5	0.1	4.7	59	42

## TYPICAL OPERATING PROCEDURES

Polarity	Current (Amps)		
	1/8 in (3.2 mm)	5/32 in (4.0 mm)	3/16 in (4.8 mm)
DC-	115-135	145-165	175-195

IMPORTANT: SPECIAL VENTILATION AND/OR EXHAUST REQUIRED

Fumes from the normal use of some welding products can contain significant quantities of components - such as chromium and manganese - which can lower the 5.0 mg/m<sup>3</sup> maximum exposure guideline for general welding fume.

BEFORE USE, READ AND UNDERSTAND THE SAFETY DATA SHEET (SDS) FOR THIS PRODUCT AND SPECIFIC INFORMATION PRINTED ON THE PRODUCT CONTAINER.

# WEARTECH® WT-12 TIG

Cobalt ▪ AWS A5.21 ERCoCr-B

## KEY FEATURES

- Cobalt, very high chromium, high carbon, high tungsten electrode
- Very resistant to wear, corrosion, and galling at high temperatures
- Intermediate alloy between WT-1 and WT-6
- Maintains hardness up to 1300°F (700°C)

## WELDING POSITIONS

All

## TYPICAL APPLICATIONS

- Chain Saw Bars
- Saw Teeth
- Extrusion Dies

## WELDING PROCESSES

- Gas Tungsten Arc Welding
- Oxyfuel Welding

## DIAMETERS / PACKAGING

Diameter in (mm)	10 lb (4.5 kg) Carton
3/32 (2.4)	B1120-240X915
1/8 (3.2)	B1120-320X915
5/32 (4.0)	B1120-400X915
3/16 (4.8)	B1120-480X915
1/4 (6.4)	B1120-640X915

## WIRE COMPOSITION

	%C	%Mn	%Si	%Cr	%Ni
<b>Requirements</b> AWS A5.21 ERCoCr-B	1.2-1.7	1.0 max	2.0 max	26-32	3.0 max
<b>Typical Results<sup>(2)</sup></b>	1.4	0.1	1.4	29.5	2.5
	%Fe	%Mo	%W	%Co	Hardness, Rc
<b>Requirements</b> AWS A5.21 ERCoCr-B	3.0 max	1.0 max	7.0 -9.5	Balance	Not Required
<b>Typical Results<sup>(2)</sup></b>	2.6	0.1	8.8	53	47

## TYPICAL OPERATING PROCEDURES

Polarity	Current (Amps) 1/8 in (3.2 mm)
DC-	115-135

IMPORTANT: SPECIAL VENTILATION AND/OR EXHAUST REQUIRED

Fumes from the normal use of some welding products can contain significant quantities of components - such as chromium and manganese - which can lower the 5.0 mg/m<sup>3</sup> maximum exposure guideline for general welding fume.

BEFORE USE, READ AND UNDERSTAND THE SAFETY DATA SHEET (SDS) FOR THIS PRODUCT AND SPECIFIC INFORMATION PRINTED ON THE PRODUCT CONTAINER.

# WEARTECH® WT-21 TIG

Cobalt ▪ AWS A5.21 ERCoCr-E

## KEY FEATURES

- Cobalt, high chromium, molybdenum electrode
- Excellent for corrosion resistance, galling, cavitation, and metal to metal wear resistance
- Not recommended for severe abrasion

## TYPICAL APPLICATIONS

- Steam Valves
- Hot Shears
- Chemical and Petrochemical Valves
- Cavation Repair
- Forging Dies

## WELDING POSITIONS

All

## WELDING PROCESSES

- Gas Tungsten Arc Welding
- Oxyfuel Welding

## DIAMETERS / PACKAGING

Diameter in (mm)	10 lb (4.5 kg) Carton
3/32 (2.4)	B1210-240X915
1/8 (3.2)	B1210-320X915
5/32 (4.0)	B1210-400X915
3/16 (4.8)	B1210-480X915
1/4 (6.4)	B1210-640X915

## WIRE COMPOSITION

	%C	%Mn	%Si	%Cr	%Ni
<b>Requirements</b> AWS A5.21 ERCoCr-E	0.15-0.40	2.0 max	1.5 max	25-30	1.5 -4.0
<b>Typical Results<sup>(2)</sup></b>	0.22	0.9	0.9	27.5	2.9
	%Fe	%Mo	%W	%Co	Hardness, Rc
<b>Requirements</b> AWS A5.21 ERCoCr-E	5.0 max	4.5-7.0	0.50 max	Balance	Not Required
<b>Typical Results<sup>(2)</sup></b>	1.5	5.6	0.1	60	27

## TYPICAL OPERATING PROCEDURES

Polarity	Current (Amps) 1/8 in (3.2 mm)
DC-	115-135

IMPORTANT: SPECIAL VENTILATION AND/OR EXHAUST REQUIRED

Fumes from the normal use of some welding products can contain significant quantities of components - such as chromium and manganese - which can lower the 5.0 mg/m<sup>3</sup> maximum exposure guideline for general welding fume.

BEFORE USE, READ AND UNDERSTAND THE SAFETY DATA SHEET (SDS) FOR THIS PRODUCT AND SPECIFIC INFORMATION PRINTED ON THE PRODUCT CONTAINER.

# WEARTECH® WT-40 TIG

Nickel ▪ AWS A5.21 ERNiCr-A

## KEY FEATURES

- Undiluted weld metal exhibits a structure containing chromium-carbides and carbides in a nickel rich matrix
- Deposits exhibit good heat and corrosion resistance
- Smooth and machinable deposits

## WELDING POSITIONS

All

## TYPICAL APPLICATIONS

- Glass Industry
- Mold Parts
- Glass Molds
- Bushings
- Plastic Extrusion
- Flight Screws

## WELDING PROCESSES

- Gas Tungsten Arc Welding
- Oxyfuel Welding

## DIAMETERS / PACKAGING

Diameter in (mm)	10 lb (4.5 kg) Carton
1/8 (3.2)	B2400-320X915
5/32 (4.0)	B2400-400X915
3/16 (4.8)	B2400-480X915

## WIRE COMPOSITION

	%C	%Mn		%Si	%Cr	%Ni
<b>Requirements</b> - AWS A5.21 ERNiCr-A	0.20-0.60	-		1.2-4.0	6.5-14.0	Remainder
<b>Typical Results</b> <sup>(1)</sup>	0.40			2.2	11	Balance
	%Fe	%Mo	%W	%Co	%B	Hardness, Rc
<b>Requirements</b> - AWS A5.21 ERNiCr-A	1.0-3.5	-	-	-	1.5-3.0	Not Required
<b>Typical Results</b> <sup>(1)</sup>	2.5	-	-	<1.5	2	35-45

<sup>(1)</sup> See test results disclaimer

### IMPORTANT: SPECIAL VENTILATION AND/OR EXHAUST REQUIRED

Fumes from the normal use of some welding products can contain significant quantities of components - such as chromium and manganese - which can lower the 5.0 mg/m<sup>3</sup> maximum exposure guideline for general welding fume.

BEFORE USE, READ AND UNDERSTAND THE SAFETY DATA SHEET (SDS) FOR THIS PRODUCT AND SPECIFIC INFORMATION PRINTED ON THE PRODUCT CONTAINER.

# WEARTECH® WT-50 TIG

Nickel ▪ AWS A5.21 ERNiCr-B

## KEY FEATURES

- Deposits provide higher hardness and abrasion than WT-40 TIG
- Resists abrasion, corrosion, galling and pitting
- Exhibits good heat and corrosion resistance
- Can be deposited on cast iron and low-to-medium carbon steel

## WELDING POSITIONS

All

## TYPICAL APPLICATIONS

- Liners
- Valve Components
- Oil Extrusion Screws
- Centrifuges

## WELDING PROCESSES

- Gas Tungsten Arc Welding
- Oxyfuel Welding

## DIAMETERS / PACKAGING

Diameter in (mm)	10 lb (4.5 kg) Carton
1/8 (3.2)	B2500-320X915
5/32 (4.0)	B2500-400X915
3/16 (4.8)	B2500-480X915
1/4 (6.4)	B2500-640X915
5/16 (8.0)	B2500-800X915

## WIRE COMPOSITION

	%C	%Mn		%Si	%Cr	%Ni
<b>Requirements</b> - AWS A5.21 ERNiCr-B	0.30-0.80	-		3.0-5.0	9.5-16.0	Remainder
<b>Typical Results</b> <sup>(1)</sup>	0.60	-		3.7	13	Balance
	%Fe	%Mo	%W	%Co	%B	Hardness, Rc
<b>Requirements</b> - AWS A5.21 ERNiCr-B	2.0-5.0	-	-	-	2.0-4.0	Not Required
<b>Typical Results</b> <sup>(1)</sup>	3.5	-	-	1.0	3	45-56

<sup>(1)</sup> See test results disclaimer

### IMPORTANT: SPECIAL VENTILATION AND/OR EXHAUST REQUIRED

Fumes from the normal use of some welding products can contain significant quantities of components - such as chromium and manganese - which can lower the 5.0 mg/m<sup>3</sup> maximum exposure guideline for general welding fume.

BEFORE USE, READ AND UNDERSTAND THE SAFETY DATA SHEET (SDS) FOR THIS PRODUCT AND SPECIFIC INFORMATION PRINTED ON THE PRODUCT CONTAINER.

# WEARTECH® WT-56 TIG

Nickel ▪ AWS A5.21: ERNiCr-B

## KEY FEATURES

- Deposits provide slightly higher hardness than WT-50 TIG
- Resists abrasion, corrosion, galling and pitting
- Smooth and machinable weld deposits

## WELDING POSITIONS

All

## TYPICAL APPLICATIONS

- Plastic Extrusion Flight Screws
- Impeller Screws
- Valve Components
- Shaft Sleeves

## WELDING PROCESSES

- Gas Tungsten Arc Welding
- Oxyfuel Welding

## DIAMETERS / PACKAGING

Diameter in (mm)	10 lb (4.5 kg) Carton
1/8 (3.2)	B2560-320X915
5/32 (4.0)	B2560-400X915
3/16 (4.8)	B2560-480X915
1/4 (6.4)	B2560-640X915
5/16 (8.0)	B2560-800X915

## WIRE COMPOSITION

	%C	%Mn		%Si	%Cr	%Ni
<b>Requirements</b> - AWS A5.21 ERNiCr-B	0.30 - 0.80	-		3.0-5.0	9.5-16.0	Remainder
<b>Typical Results</b> <sup>(1)</sup>	0.55	-		4.0	13.0	Balance
	%Fe	%Mo	%W	%Co	%B	Hardness, Rc
<b>Requirements</b> - AWS A5.21 ERNiCr-B	0.30-0.80	-	-	-	2.0-4.0	Not Required
<b>Typical Results</b> <sup>(1)</sup>	4	-	-	1.0	2.7	50-55

<sup>(1)</sup> See test results disclaimer

IMPORTANT: SPECIAL VENTILATION AND/OR EXHAUST REQUIRED

Fumes from the normal use of some welding products can contain significant quantities of components - such as chromium and manganese - which can lower the 5.0 mg/m<sup>3</sup> maximum exposure guideline for general welding fume.

BEFORE USE, READ AND UNDERSTAND THE SAFETY DATA SHEET (SDS) FOR THIS PRODUCT AND SPECIFIC INFORMATION PRINTED ON THE PRODUCT CONTAINER.

# WEARTECH® WT-60 TIG

Nickel ▪ AWS A5.21 ERNiCr-C

## KEY FEATURES

- Deposits provide higher hardness and abrasion resistance than WT-40, WT-50, WT-56 TIG
- Resists abrasion, corrosion, galling, and pitting
- Smooth and machinable weld deposits

## WELDING POSITIONS

All

## TYPICAL APPLICATIONS

- Liners
- Thrust Shoes
- Slurry Pipe & Elbows
- Valve Components
- Expellers Screws

## WELDING PROCESSES

- Gas Tungsten Arc Welding
- Oxyfuel Welding

## DIAMETERS / PACKAGING

Diameter in (mm)	10 lb (4.5 kg) Carton
1/8 (3.2)	B2600-320X915
5/32 (4.0)	B2600-400X915
3/16 (4.8)	B2600-480X915
1/4 (6.4)	B2600-640X915
5/16 (8.0)	B2600-800X915

## WIRE COMPOSITION

	%C	%Mn		%Si	%Cr	%Ni
<b>Requirements</b> - AWS A5.21 ERNiCr-C	0.50-1.00	-		3.5-5.5	12-18	Remainder
<b>Typical Results</b> <sup>(1)</sup>	0.75	-		4.5	14.0	Balance
	%Fe	%Mo	%W	%Co	%B	Hardness, Rc
<b>Requirements</b> - AWS A5.21 ERNiCr-C	3.0-5.5	-	-	-	2.5-4.5	Not Required
<b>Typical Results</b> <sup>(1)</sup>	4.5	-	-	1.0	3	54-62

<sup>(1)</sup>See test results disclaimer

### IMPORTANT: SPECIAL VENTILATION AND/OR EXHAUST REQUIRED

Fumes from the normal use of some welding products can contain significant quantities of components - such as chromium and manganese - which can lower the 5.0 mg/m<sup>3</sup> maximum exposure guideline for general welding fume.

BEFORE USE, READ AND UNDERSTAND THE SAFETY DATA SHEET (SDS) FOR THIS PRODUCT AND SPECIFIC INFORMATION PRINTED ON THE PRODUCT CONTAINER.



# LINCORE® 57-G

Severe Abrasion

## KEY FEATURES

- Designed to meet the weldability and mechanical property needs of mining equipment suppliers and rebuilders
- Maintain resistance to check cracking with proper preheat and interpass temperature
- The hard martensitic matrix provides good metal-to-metal wear resistance and moderate impact resistance when tempered
- Can be used with the bulk tungsten carbide process for additional abrasion resistance and exceptional wear life

## WELDING POSITIONS

All, except overhead

## TYPICAL APPLICATIONS

- Dragline Bucket Lips
- Augers
- Sugar Cane Harvesters
- Tire Shredders
- Tillage Tools

## SHIELDING GAS

75-90% Ar / Balance CO<sub>2</sub>  
98% Ar / 2% O<sub>2</sub>

## DIAMETERS / PACKAGING

Diameter in (mm)	10 lb (4.5 kg) Plastic Spool	25 lb (11.3 kg) Plastic Spool	500 lb (227 kg) Accu-Trak® Drum
1/16 (1.6)	ED037297	ED037298	ED037296

## MECHANICAL PROPERTIES<sup>(1)</sup>

Shielding Gas	Rockwell Hardness (R <sub>c</sub> )	Mass Loss (G65) (g)
75%Ar/25 CO <sub>2</sub>	56-59	0.36
98%Ar/2%O <sub>2</sub>	59-61	0.36

## DEPOSIT COMPOSITION<sup>(1)</sup>

On Carbon Steel (2 Layers)	%C	%Cr	%Nb	%Mn	%Mo	%Si	%V
1/16 in (1.6 mm) - Ar/CO <sub>2</sub>	0.9-1.1	7.6-1.0	1.3-1.8	1.2-1.6	0.5-0.6	0.8-1.2	1.4-1.9

## TYPICAL OPERATING PROCEDURES

Diameter, Polarity ESO – in (mm)	Approx. Current (Amps)	Voltage (Volts)	Wire Feed Speed m/min (ipm)	Deposition Rate kg/hr (lb/hr)
1/16 in (1.6 mm), DC+, 5/8 (16) 75% Ar/25% CO <sub>2</sub>	240	28	3.8 (150)	2.6 (5.8)
	340	30	6.4 (250)	4.7 (10.4)
	420	32	8.9 (350)	6.8 (15.1)
1/16 in (1.6 mm), DC+, 3/4 (20) 90% Ar/10% CO <sub>2</sub>	230	26	3.8 (150)	2.7 (6.0)
	315	27	6.4 (250)	4.9 (10.7)
	400	29	8.9 (350)	7.0 (15.4)
1/16 in (1.6 mm), DC+, 3/4 (20) 98% Ar/2% O <sub>2</sub>	220	23	3.8 (150)	2.9 (6.4)
	320	26	6.4 (250)	5.0 (11.0)
	415	28	8.9 (350)	7.1 (15.7)

<sup>(1)</sup>Based on two layers. Composition and properties depend upon dilution.

NOTE: Work area should be clean, with any previous hardfacing deposit removed, and cracks properly repaired. Cold parts should be warmed to at least 25°C (75°F). Higher preheat of 150° - 260°C (300° - 500°F) on thick parts or heavy sections.

IMPORTANT: SPECIAL VENTILATION AND/OR EXHAUST REQUIRED

Fumes from the normal use of some welding products can contain significant quantities of components - such as chromium and manganese - which can lower the 5.0 mg/m<sup>3</sup> maximum exposure guideline for general welding fume.

BEFORE USE, READ AND UNDERSTAND THE SAFETY DATA SHEET (SDS) FOR THIS PRODUCT AND SPECIFIC INFORMATION PRINTED ON THE PRODUCT CONTAINER.

# LINCORE® 60-G

Severe Abrasion

## KEY FEATURES

- Iron base chromium carbide alloy designed for applications subject to severe metal to earth abrasion with moderate impact
- Can be used at temperatures up to 704 °C (1300 °F)
- Can be used on carbon, low alloy, manganese and stainless steels and cast irons
- Deposit is limited to two layers

## WELDING POSITIONS

Flat & Horizontal

## TYPICAL APPLICATIONS

- Augers
- Bucket lips and sides
- Loaders
- Grinding equipment
- Shaper sides and blades
- Farming Tools
- Mining equipment

## SHIELDING GAS

75-90% Argon / Balance CO<sub>2</sub>  
98% Argon / 2% O<sub>2</sub>

## DIAMETERS / PACKAGING

Diameter in (mm)	10 lb (4.5 kg) Plastic Spool	25 lb (11.3 kg) Plastic Spool
0.045 (1.1)	ED036455	ED029936

## MECHANICAL PROPERTIES<sup>(1)</sup>

Rockwell Hardness (R <sub>c</sub> )	
1 Layer	2 Layer
58	60

## DEPOSIT COMPOSITION<sup>(1)</sup>

On Carbon Steel	%C	%Mn	%Si	%Cr
1 Layer	4.6	1.2	0.5	13.8
2 Layers	5.5	1.3	0.6	17.3

## TYPICAL OPERATING PROCEDURES

Diameter, Polarity, ESO - in (mm) Shielding Gas	Wire Feed Speed m/min (in/min)	Voltage (Volts)
0.045 in (1.1 mm), DC+, 3/4 (20) 75% Ar/25% CO <sub>2</sub>	5.1 (200)	23 - 24
	7.6 (300)	25 - 26
	10.2 (400)	27 - 28
0.045 in (1.1 mm), DC+, 3/4 (20) 90% Ar/10% CO <sub>2</sub>	5.1 (200)	22 - 23
	7.6 (300)	24 - 25
	10.2 (400)	26 - 27
0.045 in (1.1 mm), DC+, 3/4 (20) 98% Ar/2% O <sub>2</sub>	5.1 (200)	22 - 23
	7.6 (300)	24 - 25
	10.2 (400)	26 - 27

<sup>(1)</sup> Composition and properties depend upon dilution. Single layer deposit properties depend upon base metal and/or build-up material. <sup>(2)</sup> See test results disclaimer

IMPORTANT: SPECIAL VENTILATION AND/OR EXHAUST REQUIRED

Fumes from the normal use of some welding products can contain significant quantities of components - such as chromium and manganese - which can lower the 5.0 mg/m<sup>3</sup> maximum exposure guideline for general welding fume.

BEFORE USE, READ AND UNDERSTAND THE SAFETY DATA SHEET (SDS) FOR THIS PRODUCT AND SPECIFIC INFORMATION PRINTED ON THE PRODUCT CONTAINER.

# LINCORE® 70-G

## Severe Abrasion

### KEY FEATURES

- Exceptional wear resistance with deposits that last approximately 2-3 times longer than most chrome carbide and complex carbide alloys, especially in wet abrasion applications
- Maintains high hardness after exposure to elevated temperatures up to 1000°F (538°C)
- Running this wire as a GMAW-C wire with the recommended shielding gas will reduce fume compared to open arc (FCAW-S) applications
- Best suited for carbon and low alloy steels. Not compatible for austenitic stainless or austenitic manganese steels). Limited to a maximum of two layers
- Great for high value applications where downtime is costly or replacement parts are expensive

### WELDING POSITIONS

Flat & Horizontal Only

### TYPICAL APPLICATIONS

- Wearplate
- Crusher Rolls
- Ore Chutes
- Screw Augers

### SHIELDING GAS

75% Ar / 25% CO<sub>2</sub>  
Argon Blends

### DIAMETERS / PACKAGING

Diameter in (mm)	10 lb (4.5 kg) Spool	33 lb (15 kg) Spool	50 lb (22.7 kg) Coil
0.045 (1.1)	ED037243	ED037244	-
1/16 (1.6)	ED037245	ED037246	-
5/64 (2.0)	-	ED037247	-
7/64 (2.8)	-	-	ED037248

### MECHANICAL PROPERTIES<sup>(1)</sup>

Rockwell Hardness (R <sub>c</sub> )	Wear Resistance (ASTM G65-04 Procedure A)
67-70	0.13 g mass loss

### DEPOSIT COMPOSITION<sup>(1)</sup>

% Fe	% C	% Cr	% B	% Nb	% Al	% Mn	% Si
Balance	<3	<18	<6	<10	<5	<2	<2

<sup>(1)</sup> Composition and properties depend on dilution. Single layer deposit properties depend upon base metal and/or build-up material.

IMPORTANT: SPECIAL VENTILATION AND/OR EXHAUST REQUIRED

Fumes from the normal use of some welding products can contain significant quantities of components - such as chromium and manganese - which can lower the 5.0 mg/m<sup>3</sup> maximum exposure guideline for general welding fume.

BEFORE USE, READ AND UNDERSTAND THE SAFETY DATA SHEET (SDS) FOR THIS PRODUCT AND SPECIFIC INFORMATION PRINTED ON THE PRODUCT CONTAINER.

# WEARTECH® WT-1 GMAW-C

Cobalt ▪ AWS A5.21 ERCCoCr-C

## KEY FEATURES

- Cobalt, chrome, high tungsten
- Electrode excellent for abrasion and corrosion resistance
- Retains hardness at temperatures exceeding 1400°F (760°C)

## TYPICAL APPLICATIONS

- Wear Pads
- Mixer Rotors
- Pump Sleeves

## WELDING POSITIONS

Flat

## DIAMETERS / PACKAGING

Diameter in (mm)	25 lb (11.3 kg) Plastic Spool
0.045 (1.2)	W1010-120X15
1/16 (1.6)	W1010-160X15

## DEPOSIT COMPOSITION<sup>(1)</sup>

	%C	%Mn	%Si	%Cr	%Ni
<b>Requirements</b> AWS A5.21 ERCCoCr-C	2.0-3.0	2.0 max	2.0 max	25-33	3.0 max
<b>Typical Results<sup>(2)</sup></b>	2.5	0.8	0.3	28.9	0.2
	%Fe	%Mo	%W	%Co	Hardness, Rc
<b>Requirements</b> AWS A5.21 ERCCoCr-C	5.0 max	1.0 max	11-14	Balance	Not Required
<b>Typical Results<sup>(2)</sup></b>	3.7	0.1	11.3	50	49

## TYPICAL OPERATING PROCEDURES

Diameter in (mm)	Approx. Current (amps)	Voltage (volts)	CTWD in (mm)
0.045 (1.1)	175	20	1 (25)
	225	24	
	240	26	
	260	28	

<sup>(1)</sup>Typical undiluted weld metal. <sup>(2)</sup> See test results disclaimer.

IMPORTANT: SPECIAL VENTILATION AND/OR EXHAUST REQUIRED

Fumes from the normal use of some welding products can contain significant quantities of components - such as chromium and manganese - which can lower the 5.0 mg/m<sup>3</sup> maximum exposure guideline for general welding fume.

BEFORE USE, READ AND UNDERSTAND THE SAFETY DATA SHEET (SDS) FOR THIS PRODUCT AND SPECIFIC INFORMATION PRINTED ON THE PRODUCT CONTAINER.

# WEARTECH® WT-6 GMAW-C

Cobalt ▪ AWS A5.21 ERCCoCr-A

## KEY FEATURES

- Cobalt, high chromium, tungsten electrode
- Excellent for corrosion resistance, wear and galling
- Most flexible and widely used of the cobalt alloys due to overall performance
- Retains hardness up to 930°F (500°C)

## TYPICAL APPLICATIONS

- Shear Blades
- Fluid Flow Valves
- Extrusion Screws
- Roll Bushings
- High Temperature
- Valve Bearing Surface

## WELDING POSITIONS

Flat

## DIAMETERS / PACKAGING

Diameter in (mm)	33 lb (15 kg) Plastic Spool
0.045 (1.2)	W1060-120X15
1/16 (1.6)	W1060-160X15

## DEPOSIT COMPOSITION<sup>(1)</sup>

	%C	%Mn	%Si	%Cr	%Ni
<b>Requirements</b> AWS A5.21 ERCCoCr-A	0.7-1.4	2.0 max	2.0 max	25-32	3.0 max
<b>Typical Results<sup>(2)</sup></b>	1.2	0.8	0.5	28.2	0.3
	%Fe	%Mo	%W	%Co	Hardness, Rc
<b>Requirements</b> AWS A5.21 ERCCoCr-A	5.0 max	1.0 max	3.0 -6.0	Balance	Not Required
<b>Typical Results<sup>(2)</sup></b>	3.9	0.1	4.1	58	40

## TYPICAL OPERATING PROCEDURES

Diameter in (mm)	Approx. Current (amps)	Voltage (volts)	CTWD in (mm)
0.045 (1.1)	175	20	1 (25)
	225	24	
	240	26	
	260	28	
1/16 (1.6)	280	26	1 (25)
	300	28	

<sup>(1)</sup>Typical undiluted weld metal. <sup>(2)</sup>See test results disclaimer.

IMPORTANT: SPECIAL VENTILATION AND/OR EXHAUST REQUIRED

Fumes from the normal use of some welding products can contain significant quantities of components - such as chromium and manganese - which can lower the 5.0 mg/m<sup>3</sup> maximum exposure guideline for general welding fume.

BEFORE USE, READ AND UNDERSTAND THE SAFETY DATA SHEET (SDS) FOR THIS PRODUCT AND SPECIFIC INFORMATION PRINTED ON THE PRODUCT CONTAINER.

# WEARTECH® WT-12 GMAW-C

Cobalt ▪ AWS A5.21 ERCCoCr-B

## KEY FEATURES

- Cobalt, very high chromium, high carbon, high tungsten electrode
- Very resistant to wear, corrosion, and galling at high temperatures
- Intermediate alloy between WT-1 and WT-6
- Maintains hardness up to 1300°F (700°C)

## TYPICAL APPLICATIONS

- Chain Saw Bars
- Saw Teeth
- Extrusion Dies

## WELDING POSITIONS

Flat

## DIAMETERS / PACKAGING

Diameter in (mm)	33 lb (15 kg) Plastic Spool
0.045 (1.2)	W1120-120X15
1/16 (1.6)	W1120-160X15

## DEPOSIT COMPOSITION<sup>(1)</sup>

	%C	%Mn	%Si	%Cr	%Ni
<b>Requirements</b> AWS A5.21 ERCCoCr-B	1.2-2.0	2.0 max	2.0 max	25-32	3.0 max
<b>Typical Results<sup>(2)</sup></b>	1.5	0.9	1.0	27.4	0.2
	%Fe	%Mo	%W	%Co	Hardness, Rc
<b>Requirements</b> AWS A5.21 ERCCoCr-B	5.0 max	1.0 max	7-10	Balance	Not Required
<b>Typical Results<sup>(2)</sup></b>	3.9	0.1	8.4	53	45

## TYPICAL OPERATING PROCEDURES

Diameter in (mm)	Approx. Current (amps)	Voltage (volts)	CTWD in (mm)
0.045 (1.2)	175	20	1 (25)
	225	24	
	240	26	
	260	28	
1/16 (1.6)	280	26	1 (25)
	300	28	

<sup>(1)</sup>Typical undiluted weld metal. <sup>(2)</sup> See test results disclaimer.

IMPORTANT: SPECIAL VENTILATION AND/OR EXHAUST REQUIRED

Fumes from the normal use of some welding products can contain significant quantities of components - such as chromium and manganese - which can lower the 5.0 mg/m<sup>3</sup> maximum exposure guideline for general welding fume.

BEFORE USE, READ AND UNDERSTAND THE SAFETY DATA SHEET (SDS) FOR THIS PRODUCT AND SPECIFIC INFORMATION PRINTED ON THE PRODUCT CONTAINER.

# WEARTECH® WT-21 GMAW-C

Cobalt ▪ AWS A5.21 ERCCoCr-E

## KEY FEATURES

- Cobalt, high chromium, molybdenum electrode
- Excellent for corrosion resistance, galling, cavitation, and metal-to-metal wear resistance
- Not recommended for severe abrasion

## WELDING POSITIONS

Flat

## TYPICAL APPLICATIONS

- Steam Valves
- Hot Shears
- Chemical and Petrochemical Valves
- Cavation Repair
- Forging Dies

## DIAMETERS / PACKAGING

Diameter in (mm)	33 lb (15 kg) Plastic Spool
0.045 (1.2)	W1210-120X15
1/16 (1.6)	W1210-160X15

## DEPOSIT COMPOSITION<sup>(1)</sup>

	%C	%Mn	%Si	%Cr	%Ni
<b>Requirements</b> AWS A5.21 ERCCoCr-E	0.15-0.40	2.0 max	1.5 max	25-30	1.5 -4.0
<b>Typical Results<sup>(2)</sup></b>	0.25	0.7	0.6	27.5	2.1
	%Fe	%Mo	%W	%Co	Hardness, Rc
<b>Requirements</b> AWS A5.21 ERCCoCr-E	5.0 max	4.5-7.0	0.50 max	Balance	Not Required
<b>Typical Results<sup>(2)</sup></b>	3.9	5.5	0.1	59	24

## TYPICAL OPERATING PROCEDURES

Diameter in (mm)	Approx. Current (amps)	Voltage (volts)	CTWD in (mm)
0.045 (1.1)	175	20	1 (25)
	225	24	
	240	26	
	260	28	
1/16 (1.6)	280	26	1 (25)
	300	28	

<sup>(1)</sup>Typical undiluted weld metal. <sup>(2)</sup> See test results disclaimer.

IMPORTANT: SPECIAL VENTILATION AND/OR EXHAUST REQUIRED

Fumes from the normal use of some welding products can contain significant quantities of components - such as chromium and manganese - which can lower the 5.0 mg/m<sup>3</sup> maximum exposure guideline for general welding fume.

BEFORE USE, READ AND UNDERSTAND THE SAFETY DATA SHEET (SDS) FOR THIS PRODUCT AND SPECIFIC INFORMATION PRINTED ON THE PRODUCT CONTAINER.

# LINCORE® 30-S

Build-Up

## KEY FEATURES

- Intended for build-up before final overlay, and as a final surface for metal-to-metal wear with moderate impact
- For automatic and semiautomatic operation on mild and low alloy steels
- Good resistance to cross checking
- Unlimited deposit thickness with proper preheat and interpass temperatures and procedures

## TYPICAL APPLICATIONS

- |  |   |
|--|---|
| For Build-up:  | For Hardfacing:   |
| <ul style="list-style-type: none"> <li>Tractor rollers</li> <li>Trunnions</li> <li>Idlers</li> <li>Crane wheels</li> </ul> | <ul style="list-style-type: none"> <li>Shafts</li> <li>Track rails</li> <li>Idlers</li> </ul> |

## WELDING POSITIONS

Flat, Horizontal and Circumferential

## RECOMMENDED FLUX

Primary Flux	Secondary Flux <sup>(1)</sup>
801	802, 860

<sup>(1)</sup> 802 and 860 standard flux are not sized for semiautomatic applications; however, they can be ordered in special sizing by contacting your Lincoln Electric representative.

## DIAMETERS / PACKAGING

Diameter in (mm)	50 lb (22.7 kg) Coil	600 lb (272 kg) Speed-Feed® Drum
3/32 (2.4)	ED011200	ED011199
1/8 (3.2)	ED015889	ED015891

## MECHANICAL PROPERTIES<sup>(1)</sup>

Rockwell Hardness (R <sub>c</sub> )	
6 Layers - Under 801 or 802 Flux	6 Layers - Under 860 Flux
27	27

## DEPOSIT COMPOSITION<sup>(1)</sup>

	%C	%Mn	%Si	%Mo
6 Layers - Under 801 or 802	0.11	2.5	0.40	0.50
6 Layers - Under 860	0.11	2.7	0.60	0.50

## TYPICAL OPERATING PROCEDURES

Diameter, Polarity ESO - in (mm)	Wire Feed Speed m/min (in/min)	Voltage (Volts)	Approx. Current (Amps)	Deposition Rate kg/hr (lb/hr)
3/32 in (2.4 mm), DC+ 1 1/2 (38)	1.5 (60)	26	220	2.7 (6.0)
	3.0 (120)	27	360	5.2 (11.5)
	4.6 (180)	28	500	7.7 (17.0)
1/8 in (3.2 mm), DC+ 1 5/8 (40)	1.3 (50)	27	310	3.4 (7.5)
	2.0 (80)	28	450	6.4 (14.0)
	2.8 (110)	28	600	9.1 (20.0)

<sup>(1)</sup> Composition and properties depend upon dilution. Single layer deposit properties depend upon base metal and/or build-up material.

IMPORTANT: SPECIAL VENTILATION AND/OR EXHAUST REQUIRED

Fumes from the normal use of some welding products can contain significant quantities of components - such as chromium and manganese - which can lower the 5.0 mg/m<sup>3</sup> maximum exposure guideline for general welding fume.

BEFORE USE, READ AND UNDERSTAND THE SAFETY DATA SHEET (SDS) FOR THIS PRODUCT AND SPECIFIC INFORMATION PRINTED ON THE PRODUCT CONTAINER.



# LINCORE® 32-S

Metal-to-Metal, Build-Up

## KEY FEATURES

- Designed for build-up on 4140 drill stems in the deep hole drilling industry
- For automatic and semiautomatic operation on mild and low alloy steels
- Good resistance to cross checking
- Unlimited deposit thickness with proper preheat and interpass temperatures and procedures

## TYPICAL APPLICATIONS

- Drill stems

## RECOMMENDED FLUX

Primary Flux <sup>(1)</sup>	Secondary Flux
802	860

<sup>(1)</sup> 802 and 860 standard flux are not sized for semiautomatic applications; however, they can be ordered in special sizing by contacting your Lincoln Electric representative.

## DIAMETERS / PACKAGING

Diameter in (mm)	300 lb (136 kg) Speed-Feed® Drum	600 lb (272 kg) Speed-Feed® Drum
3/32 (2.4)	ED025656	ED025131
1/8 (3.2)		

## MECHANICAL PROPERTIES<sup>(1)</sup>

Rockwell Hardness (R <sub>c</sub> )	
2 Layers Under 802 Flux	2 Layers on 4140 Steel Under 802 Flux
28	33

## DEPOSIT COMPOSITION<sup>(1)</sup>

	%C	%Mn	%Si	%Cr	%Mo	%Ni
2 Layers w/ 802	0.05	2.20	0.60	1.80	0.33	0.07
<b>On 4140 Steel</b>						
2 Layers w/ 802	0.13	2.11	0.51	1.63	0.30	0.09

## TYPICAL OPERATING PROCEDURES

Diameter, Polarity ESO - in (mm)	Wire Feed Speed m/min (in/min)	Voltage (Volts)	Approx. Current (Amps)	Deposition Rate kg/hr (lb/hr)
<b>3/32 in (2.4 mm), DC+</b> 1 1/2 (38)	1.9 (75)	25	350	3.4 (7.5)
	2.5 (100)	25	400	4.5 (10.0)
	3.3 (130)	25	460	5.9 (13.0)
	4.2 (165)	25	510	7.5 (16.5)
<b>1/8 in (3.2 mm), DC+</b> 1 5/8 (40)	1.3 (50)	28	370	3.9 (8.5)
	2.5 (100)	28	540	7.9 (17.5)
	3.2 (125)	28	630	9.6 (21.1)
	3.8 (150)	28	720	11.8 (26.0)

<sup>(1)</sup> Composition and properties depend upon dilution. Single layer deposit properties depend upon base metal and/or build-up material.

IMPORTANT: SPECIAL VENTILATION AND/OR EXHAUST REQUIRED

Fumes from the normal use of some welding products can contain significant quantities of components - such as chromium and manganese - which can lower the 5.0 mg/m<sup>3</sup> maximum exposure guideline for general welding fume.

BEFORE USE, READ AND UNDERSTAND THE SAFETY DATA SHEET (SDS) FOR THIS PRODUCT AND SPECIFIC INFORMATION PRINTED ON THE PRODUCT CONTAINER.

# LINCORE® 35-S

Metal-to-Metal, Build-Up

## KEY FEATURES

- Intended for rolling and sliding metal-to-metal wear with moderate impact and abrasion
- For automatic and semiautomatic operation on mild and low alloy steels
- Recommended as final overlay where medium hardness and good machinability are required
- Unlimited deposit thickness with proper preheat and interpass temperatures and procedures

## TYPICAL APPLICATIONS

- |                   |                    |
|-------------------|--------------------|
| For Build-up      | For Hardfacing     |
| ▪ Tractor rollers | ▪ Mine car wheels  |
| ▪ Idlers          | ▪ Track rails      |
| ▪ Trunnions       | ▪ Shafts           |
| ▪ Crane wheels    | ▪ Bearing journals |
| ▪ Caster rolls    |                    |

## RECOMMENDED FLUXES

Primary Flux	Secondary Flux <sup>(1)</sup>
801	802, 880

<sup>(1)</sup> 802 and 860 standard flux are not sized for semiautomatic applications; however, they can be ordered in special sizing by contacting your Lincoln Electric representative.

## DIAMETERS / PACKAGING

Diameter in (mm)	50 lb (22.7 kg) Coil	600 lb (272 kg) Speed-Feed® Drum
3/32 (2.4)	ED019880	ED019883
1/8 (3.2)	ED019881	ED019884
5/32 (4.0)		ED019885

## MECHANICAL PROPERTIES<sup>(1)</sup>

Rockwell Hardness (R <sub>c</sub> )
39

## DEPOSIT COMPOSITION<sup>(1)</sup>

	%C	%Mn	%Si	%Cr	%Mo
With Recommended Neutral Flux	0.19	1.7	0.60	2.3	0.50

## TYPICAL OPERATING PROCEDURES

Diameter, Polarity ESO - in (mm)	Wire Feed Speed m/min (in/min)	Voltage (Volts)	Approx. Current (Amps)	Deposition Rate kg/hr (lb/hr)
1/8 in (3.2 mm), DC+ 1 5/8 (40)	1.3 (50)	28	340	3.6 (8.0)
	2.5 (100)	28	500	7.5 (16.5)
	3.8 (150)	28	660	11.3 (25.0)

<sup>(1)</sup> Composition and properties depend upon dilution. Single layer deposit properties depend upon base metal and/or build-up material.

<p>IMPORTANT: SPECIAL VENTILATION AND/OR EXHAUST REQUIRED</p> <p>Fumes from the normal use of some welding products can contain significant quantities of components - such as chromium and manganese - which can lower the 5.0 mg/m<sup>3</sup> maximum exposure guideline for general welding fume.</p> <p>BEFORE USE, READ AND UNDERSTAND THE SAFETY DATA SHEET (SDS) FOR THIS PRODUCT AND SPECIFIC INFORMATION PRINTED ON THE PRODUCT CONTAINER.</p>
--

# LINCORE® 40-S

Metal-to-Metal

## KEY FEATURES

- Designed for rebuilding heavy equipment undercarriages
- Deposit is machinable and hot forgeable and resists rolling and sliding metal-to-metal wear
- Use on carbon and low alloy steels for good puddle control on roundabout welding
- Limited to 4 layers

## TYPICAL APPLICATIONS

- Idlers
- Drive sprockets
- Mine car wheels

## RECOMMENDED FLUXES

Primary Flux	Secondary Flux <sup>(1)</sup>
801	802, 880

<sup>(1)</sup> 802 and 880 standard flux are not sized for semiautomatic applications; however, they can be ordered in special sizing by contacting your Lincoln Electric representative.

## DIAMETERS / PACKAGING

Diameter in (mm)	50 lb (22.7 kg) Coil	600 lb (272 kg) Speed-Feed® Drum
1/8 (3.2)	ED015892	ED015909

## MECHANICAL PROPERTIES<sup>(1)</sup>

Rockwell Hardness (R <sub>c</sub> ) 3 or More Layers After 2 Hours Post Weld Heat Treat
39 - 42

## DEPOSIT COMPOSITION<sup>(1)</sup>

	%C	%Mn	%Si	%Cr	%Mo
With Recommended Neutral Flux	0.12	2.75	0.50	3.30	0.85

## TYPICAL OPERATING PROCEDURES

Diameter, Polarity ESO - in (mm)	Wire Feed Speed m/min (in/min)	Voltage (Volts)	Approx. Current (Amps)	Deposition Rate kg/hr (lb/hr)
1/8 in (3.2 mm), DC+ 1 1/4 (32)	1.7 (65)	27	330	4.4 (9.6)
	2.3 (90)	28	425	5.9 (12.9)
	3.0 (120)	29	525	7.8 (17.3)
1/8 in (3.2 mm), DC+ 2 1/2 (65)	2.0 (80)	29	345	5.2 (11.5)
	2.8 (110)	30	425	7.3 (16.0)
	3.7 (145)	31	500	9.4 (20.8)
1/8 in (3.2 mm), DC+ 3 1/2 (90)	2.5 (100)	31	375	6.5 (14.3)
	3.3 (130)	32	435	8.6 (18.9)
	4.6 (180)	33	520	11.9 (26.1)

<sup>(1)</sup> Composition and properties depend upon dilution. Single layer deposit properties depend upon base metal and/or build-up material.

IMPORTANT: SPECIAL VENTILATION AND/OR EXHAUST REQUIRED
Fumes from the normal use of some welding products can contain significant quantities of components - such as chromium and manganese - which can lower the 5.0 mg/m <sup>3</sup> maximum exposure guideline for general welding fume.
BEFORE USE, READ AND UNDERSTAND THE SAFETY DATA SHEET (SDS) FOR THIS PRODUCT AND SPECIFIC INFORMATION PRINTED ON THE PRODUCT CONTAINER.

# LINCORE® 42-S

Metal-to-Metal

## KEY FEATURES

- Designed for rebuilding heavy equipment undercarriages
- The deposit exhibits enhanced crack resistance and toughness compared to Lincore® 40-S
- Intended to resist rolling and sliding metal-to-metal wear
- For automatic and semiautomatic operation

## TYPICAL APPLICATIONS

- Tractor rollers
- Tractor idlers
- Track pads

## RECOMMENDED FLUXES

Primary Flux	Secondary Flux
801	802, 880

<sup>(1)</sup> 802 and 880 standard flux are not sized for semiautomatic applications; however, they can be ordered in special sizing by contacting your Lincoln Electric representative.

## DIAMETERS / PACKAGING

Diameter in (mm)	300 lb (136 kg) Speed-Feed® Drum	600 lb (272 kg) Speed-Feed® Drum
1/8 (3.2)	ED029264	ED029161

## MECHANICAL PROPERTIES<sup>(1)</sup>

Rockwell Hardness (R <sub>c</sub> ) 1 Layer
40

## DEPOSIT COMPOSITION<sup>(1)</sup>

With Recommended Neutral Flux	%C	%Mn	%Si	%Cr	%Mo
<b>1/8 in Diameter (3/4 in ESO)</b>					
1 Layer	0.14	2.13	0.34	1.45	0.43
2 Layers	0.12	2.70	0.39	2.22	0.66
4 Layers	0.11	3.33	0.44	2.95	0.84
6 Layers	0.10	3.51	0.46	3.20	0.80
<b>1/8 in Diameter (1-5/8 in ESO)</b>					
1 Layer	0.14	2.49	0.33	2.02	0.60
2 Layers	0.13	3.05	0.42	2.96	0.84
4 Layers	0.13	3.41	0.47	3.15	0.99
6 Layers	0.13	3.55	0.51	3.31	1.06

## TYPICAL OPERATING PROCEDURES

Diameter, Polarity ESO - in (mm)	Wire Feed Speed m/min (in/min)	Voltage (Volts)	Approx. Current (Amps)	Deposition Rate kg/hr (lb/hr)
<b>1/8 in (3.2 mm), DC+</b> 3/4 (20)	1.3 (50)	27	350	3.8 (8.4)
	2.5 (100)	28	565	7.5 (16.5)
	3.2 (125)	29	675	9.3 (20.5)
<b>1/8 in (3.2 mm), DC+</b> 1 5/8 (40)	1.3 (50)	27	325	3.8 (8.3)
	2.5 (100)	28	510	7.5 (16.6)
	3.2 (125)	29	605	9.4 (20.8)

<sup>(1)</sup> Composition and properties depend upon dilution. Single layer deposit properties depend upon base metal and/or build-up material.

IMPORTANT: SPECIAL VENTILATION AND/OR EXHAUST REQUIRED
Fumes from the normal use of some welding products can contain significant quantities of components - such as chromium and manganese - which can lower the 5.0 mg/m <sup>3</sup> maximum exposure guideline for general welding fume.
BEFORE USE, READ AND UNDERSTAND THE SAFETY DATA SHEET (SDS) FOR THIS PRODUCT AND SPECIFIC INFORMATION PRINTED ON THE PRODUCT CONTAINER.

# LINCORE® 20

Roll Rebuilding, Build Up

## KEY FEATURES

- Metal-cored wire with moderate hardness for build-up before stainless overlay
- Good crack resistance and high compressive strength

## TYPICAL APPLICATIONS

- Caster rolls

## RECOMMENDED FLUX

Primary Flux	Secondary Flux <sup>(1)</sup>
801	802, 880

<sup>(1)</sup> 802 and 860 standard flux are not sized for semiautomatic applications; however, they can be ordered in special sizing by contacting your Lincoln Electric representative.

## DIAMETERS / PACKAGING

Diameter in (mm)	50 lb (22.7 kg) Coil	600 lb (272 kg) Speed-Feed® Drum
3/32 (2.4)	EDS18565	-
1/8 (3.2)	EDS18566	ED018569
5/32 (4.0)	-	EDS18570

## MECHANICAL PROPERTIES<sup>(1)</sup>

Rockwell Hardness (R <sub>c</sub> )
23 - 28

## DEPOSIT COMPOSITION<sup>(1)</sup>

With Recommended Neutral Flux					
%C	%Mn	%Si	%Cr	%Ni	%Mo
0.05	0.60	0.40	1.40	2.40	0.40

## TYPICAL OPERATING PROCEDURES

Diameter, Polarity ESO - in (mm)	Wire Feed Speed m/min (in/min)	Voltage (Volts)	Approx. Current (Amps)	Deposition Rate kg/hr (lb/hr)
3/32 in (2.4 mm), DC+ 3/4 (20)	1.7 (65)	24	270	3.0 (6.7)
	3.0 (120)	28	400	5.6 (12.4)
	4.4 (175)	31	500	8.2 (18.1)
1/8 in (3.2 mm), DC+ 3/4 (20)	1.5 (60)	26	400	4.7 (10.4)
	2.5 (100)	28	550	7.8 (17.3)
	3.6 (140)	30	680	11.0 (24.2)
5/32 in (4.0 mm), DC+ 1 1/2 (38)	1.4 (55)	27	520	6.6 (14.6)
	2.2 (85)	30	725	10.2 (22.5)
	2.9 (115)	32	880	13.8 (30.4)

<sup>(1)</sup> Composition and properties depend upon dilution. Single layer deposit properties depend upon base metal and/or build-up material.

IMPORTANT: SPECIAL VENTILATION AND/OR EXHAUST REQUIRED
Fumes from the normal use of some welding products can contain significant quantities of components - such as chromium and manganese - which can lower the 5.0 mg/m <sup>3</sup> maximum exposure guideline for general welding fume.
BEFORE USE, READ AND UNDERSTAND THE SAFETY DATA SHEET (SDS) FOR THIS PRODUCT AND SPECIFIC INFORMATION PRINTED ON THE PRODUCT CONTAINER.

# LINCORE® 4130

Roll Rebuilding, Build Up

## KEY FEATURES

- Metal-cored wire for general build-up
- Can be flame hardened to 38 Rockwell C (R<sub>c</sub>)
- Used on mining components such as cable drums, sheaves, gears and shafts

## TYPICAL APPLICATIONS

- Caster rolls

## RECOMMENDED FLUX

Primary Flux _____	Secondary Flux <sup>(1)</sup> _____
801	802, 880

<sup>(1)</sup> 802 and 860 standard flux are not sized for semiautomatic applications; however, they can be ordered in special sizing by contacting your Lincoln Electric representative.

## DIAMETERS / PACKAGING

Diameter in (mm)	50 lb (22.7 kg) Coil	600 lb (272 kg) Speed-Feed® Drum
3/32 (2.4)	ED015265	ED015532
1/8 (3.2)	ED015266	ED015405

## MECHANICAL PROPERTIES<sup>(1)</sup>

Rockwell Hardness (R<sub>c</sub>)

17 - 21

## DEPOSIT COMPOSITION<sup>(1)</sup>

With Recommended Neutral Flux				
%C	%Mn	%Si	%Cr	%Mo
0.12	1.10	0.30	0.80	0.20

## TYPICAL OPERATING PROCEDURES

Diameter, Polarity ESO - in (mm)	Wire Feed Speed m/min (in/min)	Voltage (Volts)	Approx. Current (Amps)	Deposition Rate kg/hr (lb/hr)
3/32 in (2.4 mm), DC+ 3/4 (20)	1.7 (65)	24	300	2.9 (6.5)
	3.0 (120)	28	410	5.4 (12.0)
	4.4 (175)	31	520	7.9 (17.5)
1/8 in (3.2 mm), DC+ 3/4 (20)	1.5 (60)	26	350	3.9 (8.5)
	2.5 (100)	28	465	7.2 (16.0)
	3.6 (140)	30	590	10.6 (23.5)

<sup>(1)</sup> Composition and properties depend upon dilution. Single layer deposit properties depend upon base metal and/or build-up material.

IMPORTANT: SPECIAL VENTILATION AND/OR EXHAUST REQUIRED

Fumes from the normal use of some welding products can contain significant quantities of components - such as chromium and manganese - which can lower the 5.0 mg/m<sup>3</sup> maximum exposure guideline for general welding fume.

BEFORE USE, READ AND UNDERSTAND THE SAFETY DATA SHEET (SDS) FOR THIS PRODUCT AND SPECIFIC INFORMATION PRINTED ON THE PRODUCT CONTAINER.

# LINCORE® 8620

Roll Rebuilding, Build Up

## KEY FEATURES

- Metal-cored wire for build-up on worn rolls
- A little softer than Lincore® 20 for easier machining

## TYPICAL APPLICATIONS

- Caster rolls

## RECOMMENDED FLUX

Primary Flux	Secondary Flux <sup>(1)</sup>
801	802, 880

<sup>(1)</sup> 802 and 860 standard flux are not sized for semiautomatic applications; however, they can be ordered in special sizing by contacting your Lincoln Electric representative.

## DIAMETERS / PACKAGING

Diameter in (mm)	50 lb (22.7 kg) Coil	600 lb (272 kg) Speed-Feed® Drum
1/8 (3.2)	ED020788	ED020791

## MECHANICAL PROPERTIES<sup>(1)</sup>

Rockwell Hardness (R <sub>c</sub> )
16 - 20

## DEPOSIT COMPOSITION<sup>(1)</sup>

With Recommended Neutral Flux					
%C	%Mn	%Si	%Cr	%Ni	%Mo
0.09	0.80	0.30	0.45	0.55	0.15

## TYPICAL OPERATING PROCEDURES

Diameter, Polarity ESO - in (mm)	Wire Feed Speed m/min (in/min)	Voltage (Volts)	Approx. Current (Amps)	Deposition Rate kg/hr (lb/hr)
1/8 in (3.2 mm), DC+ 3/4 (20)	1.5 (60)	26	400	4.7 (10.4)
	2.5 (100)	28	550	7.8 (17.3)
	3.6 (140)	30	680	11.0 (24.2)

<sup>(1)</sup> Composition and properties depend upon dilution. Single layer deposit properties depend upon base metal and/or build-up material.

IMPORTANT: SPECIAL VENTILATION AND/OR EXHAUST REQUIRED

Fumes from the normal use of some welding products can contain significant quantities of components - such as chromium and manganese - which can lower the 5.0 mg/m<sup>3</sup> maximum exposure guideline for general welding fume.

BEFORE USE, READ AND UNDERSTAND THE SAFETY DATA SHEET (SDS) FOR THIS PRODUCT AND SPECIFIC INFORMATION PRINTED ON THE PRODUCT CONTAINER.

# LINCORE® 410

Roll Rebuilding, Metal-to-Metal

## KEY FEATURES

- Metal-cored wire with a 410 martensitic stainless steel deposit
- Low carbon content and high corrosion resistance
- Soft and easily machined

## TYPICAL APPLICATIONS

- Caster rolls

## RECOMMENDED FLUX

Primary Flux	Secondary Flux <sup>(1)</sup>
801	802

<sup>(1)</sup> 802 and 860 standard flux are not sized for semiautomatic applications; however, they can be ordered in special sizing by contacting your Lincoln Electric representative.

## DIAMETERS / PACKAGING

Diameter in (mm)	50 lb (22.7 kg) Coil	600 lb (272 kg) Speed-Feed® Drum
3/32 (2.4)	ED018583	ED018588
5/32 (4.0)		

## MECHANICAL PROPERTIES<sup>(1)</sup>

Rockwell Hardness (R <sub>c</sub> )
27 - 32

## DEPOSIT COMPOSITION<sup>(1)</sup>

With Recommended Neutral Flux				
%C	%Mn	%Si	%Cr	%Ni
0.08	0.80	0.40	12.50	0.20

## TYPICAL OPERATING PROCEDURES

Diameter, Polarity ESO - in (mm)	Wire Feed Speed m/min (in/min)	Voltage (Volts)	Approx. Current (Amps)	Deposition Rate kg/hr (lb/hr)
3/32 in (2.4 mm), DC+ 3/4 (20)	1.7 (65)	24	250	2.9 (6.5)
	3.0 (120)	28	375	5.4 (12.0)
	4.4 (175)	31	450	7.9 (17.5)
5/32 in (4.0 mm), DC+ 1 1/2 (38)	1.4 (55)	27	475	5.9 (13.1)
	2.2 (85)	30	650	9.2 (20.2)
	2.9 (115)	32	800	12.4 (27.3)

<sup>(1)</sup> Composition and properties depend upon dilution. Single layer deposit properties depend upon base metal and/or build-up material.

### IMPORTANT: SPECIAL VENTILATION AND/OR EXHAUST REQUIRED

Fumes from the normal use of some welding products can contain significant quantities of components - such as chromium and manganese - which can lower the 5.0 mg/m<sup>3</sup> maximum exposure guideline for general welding fume.

BEFORE USE, READ AND UNDERSTAND THE SAFETY DATA SHEET (SDS) FOR THIS PRODUCT AND SPECIFIC INFORMATION PRINTED ON THE PRODUCT CONTAINER.



# LINCORE® 410NiMo

Roll Rebuilding, Metal-to-Metal

## KEY FEATURES

- Metal-cored wire with low carbon deposit, which forms softer, tougher martensite than other roll alloys

## TYPICAL APPLICATIONS

- Caster rolls

## RECOMMENDED FLUX

Primary Flux	Secondary Flux <sup>(1)</sup>
801	802

<sup>(1)</sup> 802 and 860 standard flux are not sized for semiautomatic applications; however, they can be ordered in special sizing by contacting your Lincoln Electric representative.

## DIAMETERS / PACKAGING

Diameter in (mm)	50 lb (22.7 kg) Coil	600 lb (272 kg) Speed-Feed® Drum
3/32 (2.4)	ED018589	
1/8 (3.2)	ED018590	ED018593
5/32 (4.0)	EDS18591	ED018594

## MECHANICAL PROPERTIES<sup>(1)</sup>

Rockwell Hardness (R <sub>c</sub> )
32 - 40

## DEPOSIT COMPOSITION<sup>(1)</sup>

With Recommended Neutral Flux					
%C	%Mn	%Si	%Cr	%Ni	%Mo
0.05	0.80	0.50	13.00	2.00	1.00

## TYPICAL OPERATING PROCEDURES

Diameter, Polarity ESO - in (mm)	Wire Feed Speed m/min (in/min)	Voltage (Volts)	Approx. Current (Amps)	Deposition Rate kg/hr (lb/hr)
<b>3/32 in (2.4 mm), DC+</b> 1 1/2 (38)	1.7 (65)	24	250	2.6 (5.8)
	3.0 (120)	28	325	4.9 (10.7)
	4.4 (175)	31	425	7.1 (15.6)
<b>1/8 in (3.2 mm), DC+</b> 1 5/8 (40)	1.5 (60)	26	325	4.3 (9.4)
	3.6 (140)	30	575	9.9 (21.8)
<b>5/32 in (4.0 mm), DC+</b> 1 5/8 (40 mm)	1.4 (55)	27	440	5.8 (12.8)
	2.2 (85)	30	575	9.0 (19.8)
	2.9 (115)	32	700	12.2 (26.8)

<sup>(1)</sup> Composition and properties depend upon dilution. Single layer deposit properties depend upon base metal and/or build-up material.

IMPORTANT: SPECIAL VENTILATION AND/OR EXHAUST REQUIRED
Fumes from the normal use of some welding products can contain significant quantities of components - such as chromium and manganese - which can lower the 5.0 mg/m <sup>3</sup> maximum exposure guideline for general welding fume.
BEFORE USE, READ AND UNDERSTAND THE SAFETY DATA SHEET (SDS) FOR THIS PRODUCT AND SPECIFIC INFORMATION PRINTED ON THE PRODUCT CONTAINER.

# LINCORE® 423L

Roll Rebuilding, Metal-to-Metal

## KEY FEATURES

- Metal-cored wire, provides a softer "as-welded" deposit than Lincore® 420
- More resistance to softening during tempering above 482 °C (900 °F)

## TYPICAL APPLICATIONS

- Caster rolls

## RECOMMENDED FLUX

Primary Flux<sup>(1)</sup>  
802

<sup>(1)</sup> 802 and 860 standard flux are not sized for semiautomatic applications; however, they can be ordered in special sizing by contacting your Lincoln Electric representative.

## DIAMETERS / PACKAGING

Diameter in (mm)	600 lb (272 kg) Speed-Feed® Drum
1/8 (3.2)	ED018551

## MECHANICAL PROPERTIES<sup>(1)</sup>

Rockwell Hardness (R <sub>c</sub> )
41-47

## DEPOSIT COMPOSITION<sup>(1)</sup>

With Recommended Neutral Flux						
%C	%Mn	%Si	%Cr	%Ni	%Mo	%V
0.15	1.20	0.40	11.50	2.00	1.00	0.15

## TYPICAL OPERATING PROCEDURES

Diameter, Polarity ESO - in (mm)	Wire Feed Speed m/min (in/min)	Voltage (Volts)	Approx. Current (Amps)	Deposition Rate kg/hr (lb/hr)
1/8 in (3.2 mm), DC+ 1 5/8 (40)	1.5 (60)	26	350	4.2 (9.3)
	2.5 (100)	28	500	7.0 (15.5)
	3.6 (140)	30	610	9.8 (21.7)

<sup>(1)</sup> Composition and properties depend upon dilution. Single layer deposit properties depend upon base metal and/or build-up material.

### IMPORTANT: SPECIAL VENTILATION AND/OR EXHAUST REQUIRED

Fumes from the normal use of some welding products can contain significant quantities of components - such as chromium and manganese - which can lower the 5.0 mg/m<sup>3</sup> maximum exposure guideline for general welding fume.

BEFORE USE, READ AND UNDERSTAND THE SAFETY DATA SHEET (SDS) FOR THIS PRODUCT AND SPECIFIC INFORMATION PRINTED ON THE PRODUCT CONTAINER.

# LINCORE® 423CR

Roll Rebuilding, Metal-to-Metal

## KEY FEATURES

- Metal-cored wire with a higher chrome deposit than Lincore® 423L for improved corrosion resistance

## TYPICAL APPLICATIONS

- Caster rolls

## RECOMMENDED FLUX

Primary Flux<sup>(1)</sup>

802

<sup>(1)</sup> 802 and 860 standard flux are not sized for semiautomatic applications; however, they can be ordered in special sizing by contacting your Lincoln Electric representative.

## DIAMETERS / PACKAGING

Diameter in (mm)	50 lb (22.7 kg) Coil	600 lb (272 kg) Speed-Feed® Drum
3/32 (2.4)	EDS18553	ED018557
1/8 (3.2)	EDS18554	

## MECHANICAL PROPERTIES<sup>(1)</sup>

Rockwell Hardness (R <sub>c</sub> )
41-47

## DEPOSIT COMPOSITION<sup>(1)</sup>

With Recommended Neutral Flux						
%C	%Mn	%Si	%Cr	%Ni	%Mo	%V
0.15	1.20	0.40	13.50	2.00	1.00	0.15

## TYPICAL OPERATING PROCEDURES

Diameter, Polarity ESO - in (mm)	Wire Feed Speed m/min (in/min)	Voltage (Volts)	Approx. Current (Amps)	Deposition Rate kg/hr (lb/hr)
<b>3/32 in (2.4 mm), DC+</b> 1 1/2 (38)	1.7 (65)	24	250	2.7 (6.0)
	3.0 (120)	28	350	5.0 (11.0)
	4.4 (175)	31	450	7.3 (16.0)
<b>1/8 in (3.2 mm), DC+</b> 1 5/8 (40)	1.5 (60)	26	375	4.5 (9.9)
	2.5 (100)	28	540	7.5 (16.5)
	3.6 (140)	30	640	10.5 (23.1)

<sup>(1)</sup> Composition and properties depend upon dilution. Single layer deposit properties depend upon base metal and/or build-up material.

IMPORTANT: SPECIAL VENTILATION AND/OR EXHAUST REQUIRED
Fumes from the normal use of some welding products can contain significant quantities of components - such as chromium and manganese - which can lower the 5.0 mg/m <sup>3</sup> maximum exposure guideline for general welding fume.
BEFORE USE, READ AND UNDERSTAND THE SAFETY DATA SHEET (SDS) FOR THIS PRODUCT AND SPECIFIC INFORMATION PRINTED ON THE PRODUCT CONTAINER.

# LINCORE® 420

Roll Rebuilding, Metal-to-Metal

## KEY FEATURES

- Metal-cored wire that is most widely used for caster roll rebuilding

## TYPICAL APPLICATIONS

- Caster rolls

## RECOMMENDED FLUX

Primary Flux	Secondary Flux
801	802

## DIAMETERS / PACKAGING

Diameter in (mm)	50 lb (22.7 kg) Coil	600 lb (272 kg) Speed-Feed® Drum
3/32 (2.4)	ED015260	ED015261
1/8 (3.2)	ED015262	ED015268
5/32 (4.0)		ED015264

## MECHANICAL PROPERTIES<sup>(1)</sup>

Rockwell Hardness (R <sub>c</sub> )
46-50

## DEPOSIT COMPOSITION<sup>(1)</sup>

With Recommended Neutral Flux			
%C	%Mn	%Si	%Cr
0.20	1.20	0.50	12.00

## TYPICAL OPERATING PROCEDURES

Diameter, Polarity ESO - in (mm)	Wire Feed Speed m/min (in/min)	Voltage (Volts)	Approx. Current (Amps)	Deposition Rate kg/hr (lb/hr)
<b>3/32 in (2.4 mm), DC+</b> 1 1/2 (38)	1.7 (65)	24	250	2.9 (6.5)
	3.0 (120)	28	375	5.4 (12.0)
	4.4 (175)	31	450	7.9 (17.5)
<b>1/8 in (3.2 mm), DC+</b> 1 5/8 (40)	1.5 (60)	26	350	4.3 (9.5)
	2.5 (100)	28	500	7.2 (15.8)
	3.6 (140)	30	625	10.0 (22.1)
<b>5/32 in (4.0 mm), DC+</b> 1 5/8 (40)	1.4 (55)	27	475	5.9 (13.1)
	2.2 (85)	30	650	9.2 (20.2)
	2.9 (115)	32	800	12.4 (27.3)

<sup>(1)</sup> Composition and properties depend upon dilution. Single layer deposit properties depend upon base metal and/or build-up material.

<p>IMPORTANT: SPECIAL VENTILATION AND/OR EXHAUST REQUIRED</p> <p>Fumes from the normal use of some welding products can contain significant quantities of components - such as chromium and manganese - which can lower the 5.0 mg/m<sup>3</sup> maximum exposure guideline for general welding fume.</p> <p>BEFORE USE, READ AND UNDERSTAND THE SAFETY DATA SHEET (SDS) FOR THIS PRODUCT AND SPECIFIC INFORMATION PRINTED ON THE PRODUCT CONTAINER.</p>
--

# LINCORE® 414N

Roll Rebuilding, Metal-to-Metal

## OPERATING PROCEDURES

Current, Amp. DC+:	400-500
Voltage:	26-30
Wire Extension:	1 1/4" - 1 1/2"

## TYPICAL APPLICATIONS

- Continuous caster rolls

## RECOMMENDED FLUX

Primary Flux	Secondary Flux
802	801

## DIAMETERS / PACKAGING

Diameter in (mm)	50 lb (22.7 kg) Coil	600 lb (272 kg) Speed-Feed® Drum
1/8 (3.2)	ED034257	ED034258

## DEPOSIT COMPOSITION<sup>(1)</sup>

%C	%Mn	%Cr	%Si	%Mo	%Ni	%N	Avg HRC
0.06	1.20	12.6	0.40	1.60	3.50	0.09	43

<sup>(1)</sup> Composition and properties depend upon dilution. Single layer deposit properties depend upon base metal and/or build-up material.

IMPORTANT: SPECIAL VENTILATION AND/OR EXHAUST REQUIRED

Fumes from the normal use of some welding products can contain significant quantities of components - such as chromium and manganese - which can lower the 5.0 mg/m<sup>3</sup> maximum exposure guideline for general welding fume.

BEFORE USE, READ AND UNDERSTAND THE SAFETY DATA SHEET (SDS) FOR THIS PRODUCT AND SPECIFIC INFORMATION PRINTED ON THE PRODUCT CONTAINER.

# LINCORE® 423N

Roll Rebuilding, Metal-to-Metal

## OPERATING PROCEDURES

Current, Amp. DC+:	400-500
Voltage:	26-30
Wire Extension:	1 1/4" - 1 1/2"

## TYPICAL APPLICATIONS

- Higher wear continuous caster rolls

## RECOMMENDED FLUX

Primary Flux	Secondary Flux
802	801

## DIAMETERS / PACKAGING

Diameter in (mm)	50 lb (22.7 kg) Coil	600 lb (272 kg) Speed-Feed® Drum
1/8 (3.2)	ED036012	ED036013

## DEPOSIT COMPOSITION<sup>(1)</sup>

%C	%Mn	%Cr	%Si	%Mo	%Ni	%V	%W	%N	Avg HRC
0.06	1.86	11.70	0.62	1.40	3.70	0.29	0.27	0.08	42

<sup>(1)</sup> Composition and properties depend upon dilution. Single layer deposit properties depend upon base metal and/or build-up material.

IMPORTANT: SPECIAL VENTILATION AND/OR EXHAUST REQUIRED

Fumes from the normal use of some welding products can contain significant quantities of components - such as chromium and manganese - which can lower the 5.0 mg/m<sup>3</sup> maximum exposure guideline for general welding fume.

BEFORE USE, READ AND UNDERSTAND THE SAFETY DATA SHEET (SDS) FOR THIS PRODUCT AND SPECIFIC INFORMATION PRINTED ON THE PRODUCT CONTAINER.

# LINCORE® 96-S

Roll Rebuilding, Metal-to-Metal

## KEY FEATURES

- Metal-cored wire which produces a high carbon, 420 stainless steel deposit
- Use where a higher hardness is required
- Can be used on work rolls and backup rolls when water spray causes pitting on tool steel deposits

## TYPICAL APPLICATIONS

- Caster rolls

## RECOMMENDED FLUX

Primary Flux _____	Secondary Flux _____
801	802

## DIAMETERS / PACKAGING

Diameter in (mm)	600 lb (272 kg) Speed-Feed® Drum
3/32 (2.4)	ED018574
1/8 (3.2)	ED018575
5/32 (4.0)	ED018576

## MECHANICAL PROPERTIES<sup>(1)</sup>

Rockwell Hardness (R <sub>c</sub> )
48-54

## DEPOSIT COMPOSITION<sup>(1)</sup>

With Recommended Neutral Flux			
%C	%Mn	%Si	%Cr
0.23	1.20	0.40	13.00

## TYPICAL OPERATING PROCEDURES

Diameter, Polarity ESO - in (mm)	Wire Feed Speed m/min (in/min)	Voltage (Volts)	Approx. Current (Amps)	Deposition Rate kg/hr (lb/hr)
<b>3/32 in (2.4 mm), DC+</b> 1 1/2 (38)	1.7 (65)	24	250	2.6 (5.7)
	2.5 (100)	28	525	7.1 (15.7)
	4.4 (175)	31	450	7.0 (15.5)
<b>1/8 in (3.2 mm), DC+</b> 1 5/8 (40)	1.5 (60)	26	360	4.3 (9.4)
	2.5 (100)	28	525	7.1 (15.7)
	3.6 (140)	30	635	10.0 (22.0)
<b>5/32 in (4.0 mm), DC+</b> 1 5/8 (40)	1.4 (55)	27	450	5.9 (12.9)
	2.2 (85)	30	650	9.1 (20.0)
	2.9 (115)	32	775	12.3 (27.1)

<sup>(1)</sup> Composition and properties depend upon dilution. Single layer deposit properties depend upon base metal and/or build-up material.

IMPORTANT: SPECIAL VENTILATION AND/OR EXHAUST REQUIRED
Fumes from the normal use of some welding products can contain significant quantities of components - such as chromium and manganese - which can lower the 5.0 mg/m <sup>3</sup> maximum exposure guideline for general welding fume.
BEFORE USE, READ AND UNDERSTAND THE SAFETY DATA SHEET (SDS) FOR THIS PRODUCT AND SPECIFIC INFORMATION PRINTED ON THE PRODUCT CONTAINER.

# LINCORE® 102W

Roll Rebuilding, Metal-to-Metal

## KEY FEATURES

- Metal-cored wire which produces a tool steel deposit that retains hardness at high working temperatures
- Used for guide rolls, and work rolls
- Can also be used as the seat on blast furnace bells and hoppers

## TYPICAL APPLICATIONS

- Work rolls
- Metal-to-metal sliding wear (where minimal or no lubrication is present)

## RECOMMENDED FLUX

Primary Flux <sup>(1)</sup>	Secondary Flux
802	801

<sup>(1)</sup> 802 and 860 standard flux are not sized for semiautomatic applications; however, they can be ordered in special sizing by contacting your Lincoln Electric representative.

## DIAMETERS / PACKAGING

Diameter in (mm)	50 lb (22.7 kg) Coil	600 lb (272 kg) Speed-Feed® Drum
3/32 (2.4)	ED018578	ED018580
1/8 (3.2)		ED018581
5/32 (4.0)		ED018582

## MECHANICAL PROPERTIES<sup>(1)</sup>

Rockwell Hardness (R <sub>c</sub> )
48-54

## DEPOSIT COMPOSITION<sup>(1)</sup>

With Recommended Neutral Flux						
%C	%Mn	%Si	%Cr	%Mo	%V	%W
0.28	1.50	0.40	6.50	1.00	0.15	1.00

## TYPICAL OPERATING PROCEDURES

Diameter, Polarity ESO - in (mm)	Wire Feed Speed m/min (in/min)	Voltage (Volts)	Approx. Current (Amps)	Deposition Rate kg/hr (lb/hr)
<b>3/32 in (2.4 mm), DC+</b> 1 5/8 (40)	1.7 (65)	24	240	2.8 (6.2)
	3.0 (120)	28	400	5.2 (11.5)
	4.4 (175)	31	500	7.6 (16.8)
<b>1/8 in (3.2 mm), DC+</b> 1 5/8 (40)	1.5 (60)	26	390	4.4 (9.8)
	2.5 (100)	28	540	7.4 (16.4)
	3.6 (140)	30	680	10.4 (23.0)
<b>5/32 in (4.0 mm), DC+</b> 1 5/8 (40)	1.4 (55)	27	500	6.4 (14.2)
	2.2 (85)	30	685	9.9 (21.9)
	2.9 (115)	32	850	13.4 (29.6)

<sup>(1)</sup> Composition and properties depend upon dilution. Single layer deposit properties depend upon base metal and/or build-up material.

IMPORTANT: SPECIAL VENTILATION AND/OR EXHAUST REQUIRED
Fumes from the normal use of some welding products can contain significant quantities of components - such as chromium and manganese - which can lower the 5.0 mg/m <sup>3</sup> maximum exposure guideline for general welding fume.
BEFORE USE, READ AND UNDERSTAND THE SAFETY DATA SHEET (SDS) FOR THIS PRODUCT AND SPECIFIC INFORMATION PRINTED ON THE PRODUCT CONTAINER.

# LINCORE® 102HC

Roll Rebuilding, Metal-to-Metal

## KEY FEATURES

- Metal-cored wire with a higher carbon content than Lincore® 102W
- Will give a higher hardness tool steel deposit
- Deposit is "hot" [above 204 °C (400 °F)] machinable, for easy sizing after welding

## TYPICAL APPLICATIONS

- Work rolls
- Metal-to-metal sliding wear (where minimal or no lubrication is present)

## RECOMMENDED FLUX

Primary Flux <sup>(1)</sup>	Secondary Flux
802	801

<sup>(1)</sup> 802 and 860 standard flux are not sized for semiautomatic applications; however, they can be ordered in special sizing by contacting your Lincoln Electric representative.

## DIAMETERS / PACKAGING

Diameter in (mm)	50 lb (22.7 kg) Coil	600 lb (272 kg) Speed-Feed® Drum
3/32 (2.4)	ED026085	ED026086
1/8 (3.2)		ED026087

## MECHANICAL PROPERTIES<sup>(1)</sup>

Rockwell Hardness (R <sub>c</sub> )
54 - 60

## DEPOSIT COMPOSITION<sup>(1)</sup>

With Recommended Neutral Flux						
%C	%Mn	%Si	%Cr	%Mo	%V	%W
0.40	2.10	1.60	6.70	1.60	0.20	1.30

## TYPICAL OPERATING PROCEDURES

Diameter, Polarity ESO - in (mm)	Wire Feed Speed m/min (in/min)	Voltage (Volts)	Approx. Current (Amps)	Deposition Rate kg/hr (lb/hr)
3/32 in (2.4 mm), DC+ 1 1/2 (38)	1.7 (65)	24	240	2.8 (6.2)
	3.0 (120)	28	400	5.2 (11.5)
	4.4 (175)	31	500	7.6 (16.8)
1/8 in (3.2 mm), DC+ 1 5/8 (40)	1.5 (60)	26	390	4.4 (9.8)
	2.5 (100)	28	540	7.4 (16.4)
	3.6 (140)	30	680	10.4 (23.0)

<sup>(1)</sup> Composition and properties depend upon dilution. Single layer deposit properties depend upon base metal and/or build-up material.

IMPORTANT: SPECIAL VENTILATION AND/OR EXHAUST REQUIRED
Fumes from the normal use of some welding products can contain significant quantities of components - such as chromium and manganese - which can lower the 5.0 mg/m <sup>3</sup> maximum exposure guideline for general welding fume.
BEFORE USE, READ AND UNDERSTAND THE SAFETY DATA SHEET (SDS) FOR THIS PRODUCT AND SPECIFIC INFORMATION PRINTED ON THE PRODUCT CONTAINER.



# LINCORE® BU-G

Build-Up

## KEY FEATURES

- Delivers deposits with moderate hardness for build-up or as final overlay
- Provides some resistance to metal-to-metal wear and moderate impact
- Unlimited layers with proper preheat and interpass temperatures and procedures

## WELDING POSITIONS

Flat & Horizontal

## TYPICAL APPLICATIONS

- Rolls
- Shafts
- Pump and shovel parts
- Pulverizer
- Plows

## SHIELDING GAS

75-90% Argon / Balance CO<sub>2</sub>

98% Argon / 2% O<sub>2</sub>

## DIAMETERS / PACKAGING

Diameter in (mm)	25 lb (11.3 kg) Plastic Spool
0.045 (1.1)	ED029079
1/16 (1.6)	ED029080

## MECHANICAL PROPERTIES<sup>(1)</sup>

As-Welded		Rockwell Hardness (R <sub>c</sub> )	Work-Hardened
21 - 33			40 - 42

## DEPOSIT COMPOSITION<sup>(1)</sup>

On Carbon Steel	%C	%Mn	%Si	%Cr	%Mo
4 Layers	0.08	1.60	0.50	0.90	0.30

## TYPICAL OPERATING PROCEDURES

Diameter, Polarity, ESO - in (mm) Shielding Gas	Wire Feed Speed m/min (in/min)	Voltage (Volts)	Approx. Current (Amps)	Deposition Rate kg/hr (lb/hr)
<b>0.045 in (1.1 mm)</b> , DC+, 5/8 (16) 75% Ar/25% CO <sub>2</sub>	5.1 (200)	29	175	1.7 (3.7)
	7.6 (300)	30	240	2.6 (5.8)
	10.2 (400)	32	300	3.6 (7.9)
<b>0.045 in (1.1 mm)</b> , DC+, 3/4 (20) 90% Ar/10% CO <sub>2</sub>	5.1 (200)	25	215	2.1 (4.7)
	7.6 (300)	27	250	3.1 (6.9)
	10.2 (400)	29	285	4.1 (9.1)
<b>0.045 in (1.1 mm)</b> , DC+, 3/4 (20) 98% Ar/2% O <sub>2</sub>	5.1 (200)	25	210	2.0 (4.5)
	7.6 (300)	26	280	3.2 (7.1)
	10.2 (400)	28	315	4.4 (9.7)
<b>1/16 in (1.6 mm)</b> , DC+, 3/4 (20) 75% Ar/25% CO <sub>2</sub>	3.8 (150)	27	280	2.8 (6.1)
	6.4 (250)	29	370	4.8 (10.5)
	8.9 (350)	31	460	6.8 (14.9)
<b>1/16 in (1.6 mm)</b> , DC+, 3/4 (20) 90% Ar/10% CO <sub>2</sub>	3.8 (150)	25	270	2.6 (5.7)
	6.4 (250)	27	375	4.9 (10.8)
	8.9 (350)	29	470	7.2 (15.9)
<b>1/16 in (1.6 mm)</b> , DC+, 3/4 (20) 98% Ar/2% O <sub>2</sub>	3.8 (150)	24	290	2.8 (6.1)
	6.4 (250)	26	390	5.0 (11.1)
	8.9 (350)	28	490	7.3 (16.1)

<sup>(1)</sup>Composition and properties depend upon dilution. Single layer deposit properties depend upon base metal and/or build-up material.

IMPORTANT: SPECIAL VENTILATION AND/OR EXHAUST REQUIRED
Fumes from the normal use of some welding products can contain significant quantities of components - such as chromium and manganese - which can lower the 5.0 mg/m <sup>3</sup> maximum exposure guideline for general welding fume.
BEFORE USE, READ AND UNDERSTAND THE SAFETY DATA SHEET (SDS) FOR THIS PRODUCT AND SPECIFIC INFORMATION PRINTED ON THE PRODUCT CONTAINER.

# LINCORE® 55-G

Metal-to-Metal

## KEY FEATURES

- Produces a deposit which resists metal-to-metal wear and mild abrasion
- The deposit results in an even harder material when used with the Bulk Tungsten Carbide process
- To be used on carbon steel and low alloy steel
- Unlimited layers with proper preheat and interpass temperatures and procedures

## TYPICAL APPLICATIONS

- Crane wheels
- Blower blades
- Bucket lips
- Dredge parts
- Tillage tools

## SHIELDING GAS

75-90% Argon / Balance CO<sub>2</sub>  
98% Argon / 2% O<sub>2</sub>

## WELDING POSITIONS

All, except overhead

## DIAMETERS / PACKAGING

Diameter in (mm)	10 lb (4.5 kg) Plastic Spool	25 lb (11.3 kg) Plastic Spool	500 lb (227 kg) Accu-Trak® Drum
0.045 (1.1)	ED036444	ED028176	ED031475
1/16 (1.6)			

## MECHANICAL PROPERTIES<sup>(1)</sup>

Shielding Gas	Rockwell Hardness (R <sub>c</sub> )		
	1 Layer	2 Layer	4 Layers
75%Ar/25%CO <sub>2</sub>	50 - 51	53 - 54	54 - 55
98%Ar/2%O <sub>2</sub>	54 - 55	55 - 56	56 - 57

## DEPOSIT COMPOSITION<sup>(1)</sup>

On Carbon Steel (2 Layers)	%C	%Mn	%Si	%Cr	%Mo
0.045 in (1.1 mm) - Ar/CO <sub>2</sub>	0.39	1.24	0.75	5.61	0.55
0.045 in (1.1 mm) - Ar/O <sub>2</sub>	0.47	1.45	0.95	6.44	0.65
1/16 in (1.6 mm) - Ar/CO <sub>2</sub>	0.41	1.24	0.75	5.3	0.57
1/16 in (1.6 mm) - Ar/O <sub>2</sub>	0.45	1.25	0.95	5.5	0.58

## TYPICAL OPERATING PROCEDURES

Diameter, Polarity, ESO - in (mm) Shielding Gas	Wire Feed Speed m/min (in/min)	Voltage (Volts)	Approx. Current (Amps)	Deposition Rate kg/hr (lb/hr)
<b>0.045 in (1.1 mm)</b> , DC+, 5/8 (16) 75% Ar/25% CO <sub>2</sub>	5.1 (200)	27	165	2.0 (4.3)
	7.6 (300)	29	225	3.0 (6.7)
	10.2 (400)	31	290	4.2 (9.2)
<b>0.045 in (1.1 mm)</b> , DC+, 3/4 (20) 90% Ar/10% CO <sub>2</sub>	5.1 (200)	25	145	2.1 (4.7)
	7.6 (300)	28	195	3.3 (7.2)
	10.2 (400)	30	245	4.4 (9.7)
<b>0.045 in (1.1 mm)</b> , DC+, 3/4 (20) 98% Ar/2% O <sub>2</sub>	5.1 (200)	25	145	2.3 (5.1)
	7.6 (300)	27	200	3.4 (7.5)
	8.9 (350)	28	225	3.9 (8.7)
	10.2 (400)	29	250	4.4 (9.8)
<b>1/16 in (1.6 mm)</b> , DC+, 5/8 (16) 75% Ar/25% CO <sub>2</sub>	3.8 (150)	28	260	2.6 (5.8)
	6.4 (250)	30	340	4.7 (10.4)
	8.9 (350)	32	420	6.8 (15.1)
<b>1/16 in (1.6 mm)</b> , DC+, 3/4 (20) 90% Ar/10% CO <sub>2</sub>	3.8 (150)	25	230	2.7 (6.0)
	6.4 (250)	27	315	4.9 (10.7)
	8.9 (350)	29	400	7.0 (15.4)
<b>1/16 in (1.6 mm)</b> , DC+, 3/4 (20) 98% Ar/2% O <sub>2</sub>	3.8 (150)	24	220	2.9 (6.4)
	6.4 (250)	26	315	5.0 (11.0)
	8.9 (350)	28	410	7.1 (15.7)

<sup>(1)</sup> Composition and properties depend upon dilution. Single layer deposit properties depend upon base metal and/or build-up material.

NOTE: Work area should be clean, with any previous hardfacing deposit removed, and cracks properly repaired. Cold parts should be warmed to at least 25°C (75°F). Higher preheat of 150° - 260°C (300° - 500°F) on thick parts or heavy sections.

<p>IMPORTANT: SPECIAL VENTILATION AND/OR EXHAUST REQUIRED</p> <p>Fumes from the normal use of some welding products can contain significant quantities of components - such as chromium and manganese - which can lower the 5.0 mg/m<sup>3</sup> maximum exposure guideline for general welding fume.</p> <p>BEFORE USE, READ AND UNDERSTAND THE SAFETY DATA SHEET (SDS) FOR THIS PRODUCT AND SPECIFIC INFORMATION PRINTED ON THE PRODUCT CONTAINER.</p>
--

# LINCORE® BU

## Build-Up

### KEY FEATURES

- Provides a tough machinable deposit for build-up or final overlay
- Delivers non-severe metal-to-metal wear with outstanding crack resistance
- Ideal for rebuilding worn parts to near final dimensions before applying final hardfacing layers which are more wear resistant
- Can also be used as the final hardfacing layer for non-severe metal-to-metal wear applications
- Unlimited layers with proper preheat and interpass temperatures and procedures

### TYPICAL APPLICATIONS

- Cable sheaves
- Crane wheels
- Drums and pulleys

### WELDING POSITIONS

Flat & Horizontal

### DIAMETERS / PACKAGING

Diameter in (mm)	25 lb (11.3 kg) Steel Spool	50 lb (22.7 kg) Coil
5/64 (2.0)	ED031115	ED022064
7/64 (2.8)		ED022065

### MECHANICAL PROPERTIES<sup>(1)</sup>

As-Welded	Rockwell Hardness (R <sub>B</sub> )	
	Work-Hardened	
78 - 90	86 - 98	

### DEPOSIT COMPOSITION<sup>(1)</sup>

	%C	%Mn	%Si	%Al
6 Layers	0.24	0.50	0.25	1.50

### TYPICAL OPERATING PROCEDURES

Diameter, Polarity ESO - in (mm)	Wire Feed Speed m/min (in/min)	Voltage (Volts)	Approx. Current (Amps)	Deposition Rate kg/hr (lb/hr)
5/64 in (2.0 mm), DC+ 2 (50)	5.1 (200)	29	280	4.6 (10.1)
	6.1 (240)	30	315	5.5 (12.1)
	6.6 (260)	30	330	6.1 (13.2)
	7.6 (300)	31	350	6.9 (15.2)
7/64 in (2.8 mm), DC+ 2 1/2 (64)	3.4 (135)	26	360	5.7 (12.6)
	3.8 (150)	27	385	6.3 (13.9)
	4.4 (175)	28	420	7.3 (16.0)
	5.1 (200)	29	450	8.2 (18.1)
	5.9 (235)	30	470	9.6 (21.1)

<sup>(1)</sup> Composition and properties depend upon dilution. Single layer deposit properties depend upon base metal and/or build-up material.

<p>IMPORTANT: SPECIAL VENTILATION AND/OR EXHAUST REQUIRED</p> <p>Fumes from the normal use of some welding products can contain significant quantities of components - such as chromium and manganese - which can lower the 5.0 mg/m<sup>3</sup> maximum exposure guideline for general welding fume.</p> <p>BEFORE USE, READ AND UNDERSTAND THE SAFETY DATA SHEET (SDS) FOR THIS PRODUCT AND SPECIFIC INFORMATION PRINTED ON THE PRODUCT CONTAINER.</p>
--

# LINCORE® 33

## Build-Up

### KEY FEATURES

- Delivers tough machinable deposits for build-up or final overlay intended for metal-to-metal wear
- Use for build-up of steel mill parts such as rougher couplings
- Build-up deposit on carbon steel and low alloy steel base metals
- It is ideal for rebuilding worn parts to near final dimensions before applying final hardfacing layers which are more wear resistant
- Unlimited layers with proper preheat and interpass temperatures and procedures

### TYPICAL APPLICATIONS

- Tractor rolls and idlers
- Shovel parts
- Mine car wheels
- Mill and crusher hammers
- Dredge pumps

### WELDING POSITIONS

Flat & Horizontal

### DIAMETERS / PACKAGING

Diameter in (mm)	14 lb (6.4 kg) Coil 56 lb (25.4 kg) Master Carton	25 lb (11.3 kg) Steel Spool	50 lb (22.7 kg) Coil
0.045 (1.2)	ED011237	ED031116	ED011238 ED011240
1/16 (1.6)		ED031117	
5/64 (2.0)		ED031118	
7/64 (2.8)			

### MECHANICAL PROPERTIES<sup>(1)</sup>

No. of Layers	Rockwell Hardness (R <sub>c</sub> )		
	As-Welded	Work-Hardened	Flame-Hardened / Water Quenched
1	14-30	28-34	-
2	26-32	32-36	38-42
3	25-34	35-38	-

### DEPOSIT COMPOSITION<sup>(1)</sup>

	%C	%Mn	%Si	%Al	%Cr	%S	%P
<b>3 Layers (0.045 in &amp; 1/16 in)</b>	0.11-0.18	1.8-2.1	0.50-0.75	1.6-1.9	1.2-1.4	0.002-0.005	0.004-0.012
<b>3 Layers (5/64 in &amp; 7/64 in)</b>	0.13-0.15	2.1-2.3	0.45-0.60	1.45-1.70	1.1-1.4	0.002-0.005	0.004-0.008

### TYPICAL OPERATING PROCEDURES

Diameter, Polarity ESO - in (mm)	Wire Feed Speed m/min (in/min)	Voltage (Volts)	Approx. Current (Amps)	Deposition Rate kg/hr (lb/hr)
<b>0.045 in (1.1 mm), DC+</b> 1 3/4 (45)	5.1 (200)	25	80	1.5 (3.3)
	8.9 (350)	28	130	2.7 (6.0)
	12.7 (500)	31	150	3.9 (8.7)
<b>1/16 in (1.6 mm), DC+</b> 1 3/4 (45)	3.8 (150)	26	125	2.1 (4.6)
	6.4 (250)	29	180	3.5 (7.8)
	8.9 (350)	32	225	5.0 (11.1)
<b>5/64 in (2.0 mm), DC+</b> 2 (50)	3.2 (125)	23	200	3.1 (6.9)
	5.1 (200)	27	290	4.9 (10.8)
	6.4 (250)	29	325	6.1 (21.1)
<b>7/64 in (2.8 mm), DC+</b> 2 1/2 (64)	3.4 (135)	26	360	5.7 (12.6)
	4.4 (175)	28	420	7.3 (16.0)
	6.0 (235)	30	470	9.6 (21.1)

<sup>(1)</sup> Composition and properties depend upon dilution. Single layer deposit properties depend upon base metal and/or build-up material.

<p><b>IMPORTANT: SPECIAL VENTILATION AND/OR EXHAUST REQUIRED</b></p> <p>Fumes from the normal use of some welding products can contain significant quantities of components - such as chromium and manganese - which can lower the 5.0 mg/m<sup>3</sup> maximum exposure guideline for general welding fume.</p> <p>BEFORE USE, READ AND UNDERSTAND THE SAFETY DATA SHEET (SDS) FOR THIS PRODUCT AND SPECIFIC INFORMATION PRINTED ON THE PRODUCT CONTAINER.</p>
---

# LINCORE® 40-0

Metal-to-Metal

## KEY FEATURES

- Higher hardness for metal-to-metal wear and mild abrasion
- Used on transfer rollers and guides, crane wheels and shafts
- Can be used on low carbon and low alloy steels
- Unlimited layers with proper preheat and interpass temperatures and procedures

## TYPICAL APPLICATIONS

- Tractor rolls
- Mine car wheels
- Guide rollers
- Bucket links and bases
- Actuating cams

## WELDING POSITIONS

Flat & Horizontal

## DIAMETERS / PACKAGING

Diameter in (mm)	25 lb (11.3 kg) Steel Spool	50 lb (22.7 kg) Coil
5/64 (2.0)	ED031119	ED025907

## MECHANICAL PROPERTIES<sup>(1)</sup>

Rockwell Hardness (R <sub>c</sub> )		
1 Layer	2 Layers	3 Layers
36	41	38

## DEPOSIT COMPOSITION<sup>(1)</sup>

	%C	%Mn	%Si	%Al	%Cr	%Mo
<b>1 Layer</b>	0.18	1.25	0.53	1.34	2.51	0.32
<b>2 Layers</b>	0.20	1.46	0.67	1.72	3.25	0.42
<b>3 Layers</b>	0.21	1.55	0.76	1.97	3.52	0.46

## TYPICAL OPERATING PROCEDURES

Diameter, Polarity ESO - in (mm)	Wire Feed Speed m/min (in/min)	Voltage (Volts)	Approx. Current (Amps)	Deposition Rate kg/hr (lb/hr)
<b>5/64 in (2.0 mm), DC+</b> 1 3/4 (45)	3.2 (125)	24	218	3.2 (7.0)
	5.1 (200)	27	282	5.0 (11.1)
	6.4 (250)	30	327	6.3 (13.9)

<sup>(1)</sup> Composition and properties depend upon dilution. Single layer deposit properties depend upon base metal and/or build-up material.

NOTE: Area to be overlaid should be clean and free of rust, oil, etc. Any previous hardfacing deposit that has been embrittled by severe work hardening should be removed. Cracks and other irregularities should be properly repaired.

Cold parts should be warmed to at least 25°C (75°F). Higher preheat of 150 - 260°C (300 - 500°F) may be necessary on thick parts or heavy sections. Interpass temperature between 150°C (300°F) and 200°C (400°F) do not affect the hardness of Lincore® 40-0 significantly.

<p>IMPORTANT: SPECIAL VENTILATION AND/OR EXHAUST REQUIRED</p> <p>Fumes from the normal use of some welding products can contain significant quantities of components - such as chromium and manganese - which can lower the 5.0 mg/m<sup>3</sup> maximum exposure guideline for general welding fume.</p> <p>BEFORE USE, READ AND UNDERSTAND THE SAFETY DATA SHEET (SDS) FOR THIS PRODUCT AND SPECIFIC INFORMATION PRINTED ON THE PRODUCT CONTAINER.</p>
--

# LINCORE® 55

Metal-to-Metal

## KEY FEATURES

- Delivers a deposit which resists metal-to-metal rolling or sliding wear as well as mild abrasion
- To be used on carbon steel, low alloy steel and manganese steel
- Unlimited layers with proper preheat and interpass temperatures and procedures

## TYPICAL APPLICATIONS

- Crane wheels
- Blower blades
- Rail ends
- Skip guides
- Cams and transfer tables

## WELDING POSITIONS

Flat & Horizontal

## DIAMETERS / PACKAGING

Diameter in (mm)	14 lb (6.4 kg) Coil 56 lb (25.4 kg) Master Carton	25 lb (11.3 kg) Steel Spool	10 lb (4.5 kg) Plastic Spool	50 lb (22.7 kg) Coil
0.045 (1.1)	ED011277	ED031120	ED037254	ED011278 ED011280
1/16 (1.6)		ED031121		
5/64 (2.0)		ED031122		
7/64 (2.8)				

## MECHANICAL PROPERTIES<sup>(1)</sup>

No. of Layers	Rockwell Hardness (R <sub>c</sub> )			
	As-Welded	Work-Hardened	180 °C (350 °F) Interpass Temp	Flame-Hardened / Water Quenched
1	50 - 59	53 - 62	50 - 55	-
2	50 - 60	56 - 62	55 - 59	52 - 54

## DEPOSIT COMPOSITION<sup>(1)</sup>

	%C	%Mn	%Si	%Al	%Cr	%Mo	%S	%P
0.045 in & 1/16 in	0.45	1.3	0.53	1.4	5.3	0.80	0.004	0.010
5/64 in & 7/64 in	0.45	1.4	0.60	1.4	5.3	0.80	0.004	0.010

## TYPICAL OPERATING PROCEDURES

Diameter, Polarity ESO - in (mm)	Wire Feed Speed m/min (in/min)	Voltage (Volts)	Approx. Current (Amps)	Deposition Rate kg/hr (lb/hr)
<b>0.045 in (1.1 mm), DC+</b> 1 3/4 (45)	5.1 (200)	25	85	1.6 (3.6)
	8.9 (350)	28	125	3.0 (6.6)
	12.7 (500)	31	165	4.3 (9.4)
<b>1/16 in (1.6 mm), DC+</b> 1 3/4 (45)	3.8 (150)	26	125	2.2 (4.8)
	6.4 (250)	29	195	3.8 (8.4)
	8.9 (350)	32	245	5.5 (12.1)
<b>5/64 in (2.0 mm), DC+</b> 1 3/4 (45)	3.2 (125)	24	190	3.2 (7.0)
	5.1 (200)	27	295	5.0 (11.0)
	6.4 (250)	30	330	6.2 (13.7)
<b>7/64 in (2.8 mm), DC+</b> 2 1/2 (64)	2.3 (90)	25	280	3.8 (8.4)
	3.2 (125)	27	350	5.2 (11.5)
	4.4 (175)	30	420	7.3 (16.0)

<sup>(1)</sup> Composition and properties depend upon dilution. Single layer deposit properties depend upon base metal and/or build-up material.

NOTE: Area to be overlaid should be clean and free of rust, oil, etc. Any previous hardfacing deposit that has been embrittled by severe work hardening should be removed. Cracks and other irregularities should be properly repaired.

Cold parts should be warmed to at least 25°C (75°F). Higher preheat of 150 - 260°C (300 - 500°F) may be necessary on thick parts or heavy sections. Interpass temperature between 150°C (300°F) and 200°C (400°F) do not affect the hardness of Lincore® 55 significantly.

IMPORTANT: SPECIAL VENTILATION AND/OR EXHAUST REQUIRED
Fumes from the normal use of some welding products can contain significant quantities of components - such as chromium and manganese - which can lower the 5.0 mg/m <sup>3</sup> maximum exposure guideline for general welding fume.
BEFORE USE, READ AND UNDERSTAND THE SAFETY DATA SHEET (SDS) FOR THIS PRODUCT AND SPECIFIC INFORMATION PRINTED ON THE PRODUCT CONTAINER.

# LINCORE® T & D

Metal-to-Metal

## KEY FEATURES

- Delivers a deposit similar to H12 tool steel
- For build-up of tool steel dies and edges, or applying wear resistance surface on carbon or low alloy steels
- To be used on carbon steel, low alloy steel or tool steel

## TYPICAL APPLICATIONS

- Punch dies
- Shear blades

## WELDING POSITIONS

Flat & Horizontal

## DIAMETERS / PACKAGING

Diameter in (mm)	25 lb (11.3 kg) Steel Spool
1/16 (1.6)	ED031134

## MECHANICAL PROPERTIES<sup>(1)</sup>

	Rockwell Hardness (R <sub>c</sub> )	
	As-Welded	Tempered at 540°C (1000°F)
	48 - 55	55 - 65

## DEPOSIT COMPOSITION<sup>(1)</sup>

	%C	%Mn	%Si	%Al	%Cr	%Mo	%W
6 Layers Open Arc	0.65	1.5	0.8	1.8	7.0	1.4	1.6
6 Layers w/ 802 Flux	0.50	1.9	1.0	1.0	7.0	1.4	1.6

## TYPICAL OPERATING PROCEDURES

Diameter, Polarity ESO - in (mm)	Wire Feed Speed m/min (in/min)	Voltage (Volts)	Approx. Current (Amps)	Deposition Rate kg/hr (lb/hr)
<b>1/16 in (1.6 mm), DC+</b> 1 1/4 (32)	3.8 (150)	22	170	2.4 (5.4)
	5.1 (200)	23	210	3.6 (7.9)
	6.4 (250)	24	250	4.1 (8.9)
	7.6 (300)	25	270	4.9 (10.8)
	8.9 (350)	26	300	5.4 (12.0)

<sup>(1)</sup> Composition and properties depend upon dilution. Single layer deposit properties depend upon base metal and/or build-up material.

NOTE: Minimum preheat and interpass temperatures of 315°C (600°F) are essential for crack-free welding on mild steel or low alloy steel. For crack-free welding on tool steel parts, preheat of 538°C (1000°F) or higher may be necessary. After welding, very slow cooling to 121°C (250°F) is usually required. This can be followed by post-weld heat treating at 538° - 593°C (1000° - 1100°F) to develop maximum hardness.

IMPORTANT: SPECIAL VENTILATION AND/OR EXHAUST REQUIRED
Fumes from the normal use of some welding products can contain significant quantities of components - such as chromium and manganese - which can lower the 5.0 mg/m <sup>3</sup> maximum exposure guideline for general welding fume.
BEFORE USE, READ AND UNDERSTAND THE SAFETY DATA SHEET (SDS) FOR THIS PRODUCT AND SPECIFIC INFORMATION PRINTED ON THE PRODUCT CONTAINER.

# LINCORE® M

Severe Impact

## KEY FEATURES

- Deposit resists severe impact as well as moderate abrasion
- Produces an austenitic manganese deposit that work-hardens
- Recommended for build-up and repair of Hadfield-type austenitic manganese materials as well as carbon and low alloy steels
- Unlimited layers with proper preheat and interpass temperatures and procedures

## TYPICAL APPLICATIONS

- Hammers
- Dredge parts
- Crushers
- Breaker bars
- Buckets

## WELDING PROCESSES

Flat

## DIAMETERS / PACKAGING

Diameter in (mm)	25 lb (11.3 kg) Steel Spool	50 lb (22.7 kg) Coil	125 lb (56.7 kg) Speed-Feed® Drum	600 lb (272 kg) Speed-Feed® Drum
0.045 (1.1)	ED031128			
1/16 (1.6)	ED031129			
5/64 (2.0)	ED031130	ED011160		
7/64 (2.8)		ED011164	ED011163	ED011162

## MECHANICAL PROPERTIES<sup>(1)</sup>

As-Welded	Rockwell Hardness (R <sub>c</sub> )	
	Work Hardened	
18 - 28	30 - 48	

## DEPOSIT COMPOSITION<sup>(1)</sup>

	%C	%Mn	%Si	%Cr	%Ni
Open Arc	0.60	13.0	0.4	4.9	0.5

## TYPICAL OPERATING PROCEDURES

Diameter, Polarity ESO - in (mm)	Wire Feed Speed m/min (in/min)	Voltage (Volts)	Approx. Current (Amps)	Deposition Rate kg/hr (lb/hr)
<b>0.045 in (1.1 mm), DC+</b> 1 (25)	5.1 (200)	22	80	1.5 (3.3)
	8.9 (350)	24	145	2.7 (6.0)
	12.7 (500)	26	185	4.4 (9.6)
<b>1/16 in (1.6 mm), DC+</b> 1 1/8 (30)	3.8 (150)	23	130	2.2 (4.9)
	6.4 (250)	25	200	3.9 (8.6)
	8.9 (350)	27	250	5.6 (12.4)
<b>5/64 in (2.0 mm), DC+</b> 1 1/4 (32)	3.2 (125)	24	240	2.9 (6.4)
	4.4 (175)	27	300	4.2 (9.3)
	6.4 (250)	29	360	6.2 (13.6)
<b>7/64 in (2.8 mm), DC+</b> 1 3/4 (45)	1.9 (75)	25	240	3.5 (7.8)
	3.2 (125)	27	360	6.2 (13.6)
	3.8 (150)	28	395	7.5 (16.6)
<b>7/64 in (2.8 mm), DC+</b> 2 1/2 (64)	1.9 (75)	25	240	3.6 (8.0)
	4.4 (175)	30	400	8.8 (19.5)
	5.7 (225)	32	455	11.6 (25.6)

<sup>(1)</sup> Composition and properties depend upon dilution. Single layer deposit properties depend upon base metal and/or build-up material.

NOTE: As with all austenitic manganese welding products, interpass temperatures should be limited to 260°C (500°F) maximum. A stringer bead, or at most, a slight weave is recommended to limit heat build-up. Excessive heat build-up causes manganese carbide precipitation which damages the toughness of austenitic manganese.

<p>IMPORTANT: SPECIAL VENTILATION AND/OR EXHAUST REQUIRED</p> <p>Fumes from the normal use of some welding products can contain significant quantities of components - such as chromium and manganese - which can lower the 5.0 mg/m<sup>3</sup> maximum exposure guideline for general welding fume.</p> <p>BEFORE USE, READ AND UNDERSTAND THE SAFETY DATA SHEET (SDS) FOR THIS PRODUCT AND SPECIFIC INFORMATION PRINTED ON THE PRODUCT CONTAINER.</p>
--



# LINCORE® 15CRMN

Severe Impact

## KEY FEATURES

- Provides an austenitic manganese deposit which exhibits very good crack resistance
- Work-hardens for overlay or joining austenitic manganese steel to itself or to carbon steel
- Can be used as a build-up layer before capping with abrasion resistant alloys
- Can be used in open arc mode for joining austenitic manganese steel to carbon steel, low alloy steel, austenitic manganese steel, or stainless steel
- Unlimited layers with proper preheat and interpass temperatures and procedures

## TYPICAL APPLICATIONS

- Spreader cones
- Crusher hammers
- Austenitic manganese parts

## WELDING POSITIONS

Flat & Horizontal

## DIAMETERS / PACKAGING

Diameter in (mm)	25 lb (11.3 kg) Steel Spool	50 lb (22.7 kg) Coil	125 lb (56.7 kg) Speed-Feed® Drum
5/64 (2.0)	ED031126	ED022060	
7/64 (2.8)		ED022061	ED022068

## MECHANICAL PROPERTIES<sup>(1)</sup>

Rockwell Hardness (R <sub>c</sub> )	
As-Welded	Work-Hardened
18 - 22	40-50

## DEPOSIT COMPOSITION<sup>(1)</sup>

	%C	%Mn	%Si	%Cr
6 Layers Open Arc	0.4	15.0	0.25	16.0
6 Layers w/ 801 Flux	0.4	15.0	0.6	16.0

## TYPICAL OPERATING PROCEDURES

Diameter, Polarity ESO - in (mm)	Wire Feed Speed m/min (in/min)	Voltage (Volts)	Approx. Current (Amps)	Deposition Rate kg/hr (lb/hr)
5/64 in (2.0 mm), DC+ 1 1/4 (32)	3.2 (125)	26	210	3.3 (7.3)
	5.1 (200)	29	280	5.3 (11.7)
	6.4 (250)	30	320	6.8 (15.1)
	8.9 (350)	32	380	9.7 (21.3)
7/64 in (2.8 mm), DC+ 1 3/4 (45)	1.9 (75)	26	250	2.5 (5.5)
	3.2 (125)	28	320	5.1 (11.3)
	3.8 (150)	29	350	6.6 (14.6)
	4.4 (175)	30	380	7.5 (16.4)
7/64 in (2.8 mm), DC+ 2 1/2 (64)	3.8 (150)	30	320	6.7 (14.9)
	5.1 (200)	33	390	8.7 (19.2)
	5.7 (225)	34	410	9.8 (21.7)
	6.4 (250)	35	425	11.4 (25.1)

<sup>(1)</sup> Composition and properties depend upon dilution. Single layer deposit properties depend upon base metal and/or build-up material.

NOTE: As with all austenitic manganese welding products, interpass temperatures should be limited to 260°C (500°F) maximum. A stringer bead, or at most, a slight weave is recommended to limit heat build-up. Excessive heat build-up causes manganese carbide precipitation which damages the toughness of austenitic manganese.

IMPORTANT: SPECIAL VENTILATION AND/OR EXHAUST REQUIRED

Fumes from the normal use of some welding products can contain significant quantities of components - such as chromium and manganese - which can lower the 5.0 mg/m<sup>3</sup> maximum exposure guideline for general welding fume.

BEFORE USE, READ AND UNDERSTAND THE SAFETY DATA SHEET (SDS) FOR THIS PRODUCT AND SPECIFIC INFORMATION PRINTED ON THE PRODUCT CONTAINER.

# LINCORE® FROG MANG®

Severe Impact

## KEY FEATURES

- Designed for repair of manganese frogs and manganese crossing diamonds in the railroad industry
- High alloy austenitic manganese deposit
- Unlimited layers with proper preheat and interpass temperatures and procedures

## TYPICAL APPLICATIONS

- Manganese crossing diamonds
- Manganese railroad frogs

## WELDING POSITIONS

Flat & Horizontal

## DIAMETERS / PACKAGING

Diameter in (mm)	9 lb (4 kg) Plastic Spool 36 lb (16.3 kg) Master Carton	25 lb (11.3 kg) Steel Spool
1/16 (1.6)	ED034485	ED026106
5/64 (2.0)		ED026105

## MECHANICAL PROPERTIES<sup>(1)</sup>

Rockwell Hardness (R <sub>c</sub> )	
As-Welded	Work-Hardened
20 - 30	40 - 50

## DEPOSIT COMPOSITION<sup>(1)</sup>

	%C	%Mn	%Si	%Cr
6 Layers	<2	<30	<1	<10

## TYPICAL OPERATING PROCEDURES

Diameter, Polarity ESO - in (mm)	Wire Feed Speed m/min (in/min)	Voltage (Volts)	Approx. Current (Amps)	Deposition Rate kg/hr (lb/hr)
1/16 in (1.6 mm), DC+ 1 (25)	5.1 (200)	27	220	3.0 (6.7)
	6.4 (250)	29	250	4.0 (8.7)
	8.3 (325)	32	300	5.3 (11.6)
5/64 in (2.0 mm), DC+ 1 1/4 (32)	3.8 (150)	27	240	3.4 (7.4)
	5.1 (200)	29	290	4.9 (10.7)
	6.4 (250)	31	340	6.4 (14.0)

<sup>(1)</sup> Composition and properties depend upon dilution. Single layer deposit properties depend upon base metal and/or build-up material.

NOTE: Remove all damaged and foreign material by the air-carbon arc gouging process and grinding. Make sure all defective metal is removed. In the event hairline cracks remain at flangeway depth, use a 1/8 in diameter E308 stainless product, such as Blue Max® or Red Baron® 308L AC-DC to tie up these cracks and avoid hot cracking during the buildup process. Use only light amounts and do not build-up with E308 stainless. It is for use in emergency situations where no other alternative is available to repair flangeway cracks. As with all austenitic manganese welding products, interpass temperatures should be limited to 260°C (500°F) maximum. A stringer bead, or at most, a slight weave is recommended to limit heat build-up. Excessive heat build-up causes manganese carbide precipitation which damages the toughness of austenitic manganese.

IMPORTANT: SPECIAL VENTILATION AND/OR EXHAUST REQUIRED
Fumes from the normal use of some welding products can contain significant quantities of components - such as chromium and manganese - which can lower the 5.0 mg/m <sup>3</sup> maximum exposure guideline for general welding fume.
BEFORE USE, READ AND UNDERSTAND THE SAFETY DATA SHEET (SDS) FOR THIS PRODUCT AND SPECIFIC INFORMATION PRINTED ON THE PRODUCT CONTAINER.

# LINCORE® SUPER RAIL™

Severe Impact

## KEY FEATURES

- Reduce carbon steel repairs by 50%
- Consistent wire feeding with next generation lubrication
- Low material distortion on impact
- Work hardens faster without cracking
- Remove slag easily with hand tools

## TYPICAL APPLICATIONS

- Rail Ends/Points
- Rail Crossing Points

## WELDING POSITIONS

Flat and Horizontal

## DIAMETERS / PACKAGING

Diameters in (mm)	36 lb. (16.32kg) Carton	25 lb (11.35 kg) Spool
1/16 (1.6)	ED035353	ED035354
5/64 (2.0)	ED034800	ED034801

## DEPOSIT COMPOSITION<sup>(1)</sup>

	%C	%Mn	%Si	%Cr	%Mo	%Ni	%Al
4 Layers	<1	<5	<2	<5	<1	<3	<3

## TYPICAL OPERATING PROCEDURES

Diameter, Polarity Shielding Gas ESO - in (mm)	Wire Feed Speed m/min (in/min)	Voltage (Volts)	Approx. Current (amps)	Deposition Rate kg/hr (lb/hr)
5/64 in (2.0 mm), DC+ 1 1/2 (37)	3.2 (125)	24	218	7.0 (3.2)
	5.1 (200)	27	282	11.1 (5.0)
	6.4 (250)	30	327	13.9 (6.3)
1/16 in (1.6 mm), DC+ 1 (25)	5.1 (200)	25	220	3.0 (6.7)
	6.4 (250)	27	250	4.0 (8.7)
	8.3 (325)	29	300	5.3 (11.6)

<sup>(1)</sup> Composition and properties depend upon dilution. Single layer deposit properties depend upon base metal and/or build-up material.

IMPORTANT: SPECIAL VENTILATION AND/OR EXHAUST REQUIRED

Fumes from the normal use of some welding products can contain significant quantities of components - such as chromium and manganese - which can lower the 5.0 mg/m<sup>3</sup> maximum exposure guideline for general welding fume.

BEFORE USE, READ AND UNDERSTAND THE SAFETY DATA SHEET (SDS) FOR THIS PRODUCT AND SPECIFIC INFORMATION PRINTED ON THE PRODUCT CONTAINER.

# LINCORE® 50

## Abrasion and Impact

### KEY FEATURES

- Delivers an abrasion resistant deposit, even under conditions of moderate impact
- Larger wire diameter sizes may be used for the submerged arc process
- Can be used on low carbon, medium carbon, low alloy, manganese and stainless steels
- Limited to 4 layers

### TYPICAL APPLICATIONS

- Crusher rolls
- Dredge cutter teeth
- Ore chute baffles
- Muller plows and tires
- Coal mining cutting teeth

### WELDING POSITIONS

Flat & Horizontal

### DIAMETERS / PACKAGING

Diameter in (mm)	25 lb (11.3 kg) Steel Spool	10 lb (4.5 kg) Plastic Spool	50 lb (22.7 kg) Coil	125 lb (56.7 kg) Speed-Feed® Drum
0.045 (1.1)	ED031123	ED037270		
1/16 (1.6)	ED031124	ED037261	ED020829	
5/64 (2.0)	ED031125		ED017825	
7/64 (2.8)			ED011275	ED011274

### MECHANICAL PROPERTIES<sup>(1)</sup>

	Rockwell Hardness (R <sub>c</sub> )		
	1 Layer	2 Layers	3 Layers
<b>On Mild Steel</b>	34-37	44-48	48-52
<b>On 0.50% Carbon Steel</b>	41-43	47-50	50-53
<b>On Austenitic Mn Steel</b>	-	43-45	48-50
<b>with 801 Flux</b>	38-43	47-52	48-56

### DEPOSIT COMPOSITION<sup>(1)</sup>

	%C	%Mn	%Si	%Al	%Cr	%Mo
<b>Open Arc</b>						
0.045 in & 1/16 in	2.4	1.3	1.0	0.6	11.4	-
5/64 in & 7/64 in	2.0	0.9	1.0	0.6	9.2	0.5
<b>Submerged Arc</b>						
<b>5/64 in &amp; 7/64 in</b>						
w/ 801 Flux	2.5	1.1	1.3	0.4	10.1	0.5
w/ 860 Flux	2.5	2.0	1.7	0.2	11.0	0.5

### TYPICAL OPERATING PROCEDURES

Diameter, Polarity ESO - in (mm)	Wire Feed Speed m/min (in/min)	Voltage (Volts)	Approx. Current (Amps)	Deposition Rate kg/hr (lb/hr)
<b>0.045 in (1.1mm), DC+</b> 1 (25)	5.1 (200)	19-21	120	1.9 (4.2)
	10.2 (400)	23-25	190	3.9 (8.5)
	15.2 (600)	27-29	250	5.8 (12.8)
<b>1/16 in (1.6 mm), DC+</b> 1 (25)	3.8 (150)	22-24	175	2.7 (5.9)
	8.4 (350)	29-31	325	6.2 (13.6)
	11.4 (450)	32-34	365	7.9 (17.5)
<b>5/64 in (2.0 mm), DC+</b> 1 1/4 (32)	3.2 (125)	27	210	3.4 (7.4)
	5.1 (200)	31	325	5.4 (11.9)
	6.4 (250)	33	380	6.8 (14.9)
<b>7/64 in (2.8 mm), DC+</b> 1 1/4 (32)	2.0 (80)	26	315	3.9 (8.6)
	2.5 (100)	27	375	4.9 (10.7)
	3.3 (130)	29	450	6.4 (14.0)
<b>7/64 in (2.8 mm), DC+</b> 2 1/2 (64)	2.5 (100)	27	315	4.9 (10.7)
	3.3 (130)	29	370	6.4 (14.0)
	4.4 (175)	31	450	8.6 (19.0)
<b>With Recommended Neutral Fluxes</b>				
<b>7/64 in (2.8 mm), DC+</b> 1 1/4 (32)	2.5 (100)	29	400	5.2 (11.4)
	3.0 (120)	30	450	6.2 (13.7)
	4.4 (175)	33	540	9.1 (20.0)

<sup>(1)</sup> Composition and properties depend upon dilution. Single layer deposit properties depend upon base metal and/or build-up material.

IMPORTANT: SPECIAL VENTILATION AND/OR EXHAUST REQUIRED

Fumes from the normal use of some welding products can contain significant quantities of components - such as chromium and manganese - which can lower the 5.0 mg/m<sup>3</sup> maximum exposure guideline for general welding fume.

BEFORE USE, READ AND UNDERSTAND THE SAFETY DATA SHEET (SDS) FOR THIS PRODUCT AND SPECIFIC INFORMATION PRINTED ON THE PRODUCT CONTAINER.

# LINCORE® 60-0

Severe Abrasion

## KEY FEATURES

- Deposits feature higher alloy levels than to resist both abrasion and moderate impact
- Can be used at temperatures up to 704 °C (1300 °F)
- To be used on carbon, low alloy, manganese, stainless steels and cast iron
- Deposit is limited to two layers

## TYPICAL APPLICATIONS

- Bucket lips
- Crusher hammers
- Ore chutes
- Dozer blades
- Ripper teeth

## WELDING POSITIONS

Flat & Horizontal

## DIAMETERS / PACKAGING

Diameter in (mm)	25 lb (11.3 kg) Steel Spool	10 lb (4.5 kg) Plastic Spool	50 lb (22.7 kg) Coil
0.045 (1.1)	ED031131	ED037262	
1/16 (1.6)	ED031132	ED037263	
5/64 (2.0)	ED031133		ED019887
7/64 (2.8)			ED019888

## MECHANICAL PROPERTIES<sup>(1)</sup>

Rockwell Hardness (R <sub>c</sub> )	
55-60	

## DEPOSIT COMPOSITION<sup>(1)</sup>

	%C	%Mn	%Si	%Al	%Cr
<b>2 Layers Open Arc</b>	3.7 - 4.3	0.8 - 0.9	0.8 - 1.0	0.3 - 0.4	20.0 - 21.3
<b>2 Layers w/ 802 Flux</b>	3.6 - 4.0	1.0 - 1.1	1.0 - 1.1	0.2 - 0.3	17.4 - 18.5

## TYPICAL OPERATING PROCEDURES

Diameter, Polarity ESO - in (mm)	Wire Feed Speed m/min (in/min)	Voltage (Volts)	Approx. Current (Amps)	Deposition Rate kg/hr (lb/hr)
<b>0.045 in (1.1mm), DC+</b> 1 (25)	5.1 (200)	21	125	1.9 (4.1)
	10.2 (400)	25	185	3.7 (8.2)
	12.7 (500)	27	210	4.7 (10.3)
<b>1/16 in (1.6 mm), DC+</b> 7/8 (22)	5.1 (200)	28	240	3.4 (7.6)
	7.6 (300)	31	300	5.1 (11.2)
	11.4 (450)	33	350	7.5 (16.6)
<b>5/64 in (2.0 mm), DC+</b> 1 1/4 (32)	3.2 (125)	26	250	3.4 (7.4)
	5.1 (200)	30	350	5.4 (12.0)
	6.4 (250)	32	400	6.9 (15.1)
<b>7/64 in (2.8 mm), DC+</b> 1 1/8 (30)	1.9 (75)	27	250	3.4 (7.4)
	3.2 (125)	30	340	5.4 (11.9)
	4.4 (175)	32	420	7.5 (16.5)
<b>With Recommended Neutral Fluxes</b>				
<b>7/64 in (2.8 mm), DC+</b> 1 1/8 (30)	2.5 (100)	30	295	4.4 (9.6)
	3.2 (125)	32	340	5.4 (11.9)
	4.4 (175)	34	420	7.5 (16.5)

<sup>(1)</sup> Composition and properties depend upon dilution. Single layer deposit properties depend upon base metal and/or build-up material.

NOTE: Deposit thickness limit is two layers unless high travel speed is used to obtain very closely spaced check cracks. Many layers can be used with high travel speed and small bead sizes to ensure close-spaced check cracks. Lincore® 60-0 deposit cross cracks (commonly called cross-checking) on cooling. This is desirable, since cross-cracking of the deposit relieves cooling stresses and prevents spalling.

IMPORTANT: SPECIAL VENTILATION AND/OR EXHAUST REQUIRED
Fumes from the normal use of some welding products can contain significant quantities of components - such as chromium and manganese - which can lower the 5.0 mg/m <sup>3</sup> maximum exposure guideline for general welding fume.
BEFORE USE, READ AND UNDERSTAND THE SAFETY DATA SHEET (SDS) FOR THIS PRODUCT AND SPECIFIC INFORMATION PRINTED ON THE PRODUCT CONTAINER.

# LINCORE® ULTRA K

Severe Abrasion

## KEY FEATURES

- Chrome carbide deposit provides economical abrasion resistance
- Superior manufacturing process eliminates seam issues and empty tube
- Consistent deposit chemistry and hardness at recommended procedures
- Low spatter and virtually no slag clean up required
- Limited to 2 layers max

## TYPICAL APPLICATIONS

- Wearplate
- Crusher rolls
- Ore Chutes
- Screw Augers

## WELDING POSITIONS

Flat & Horizontal Only

## DIAMETERS / PACKAGING

Diameter in (mm)	600 lb (272 kg) Speed-Feed® Drum
1/8 (3.2)	ED034802

## MECHANICAL PROPERTIES<sup>(1)</sup>

Rockwell Hardness (R <sub>c</sub> )
56-62

## DEPOSIT COMPOSITION<sup>(1)</sup>

%Fe	%C	%Cr	%Mn	%Si	%Al
Balance	<10	<35	<5	<2	<1

## TYPICAL OPERATING PROCEDURES

Diameter, Polarity ESO - in (mm)	Wire Feed Speed m/min (ipm)	Voltage (Volts)	Approx. Current (Amps)
1/8 in (3.2 mm), DC+ 1 1/2 (38) FCAW-S	4.8 (190)	29	~500

<sup>(1)</sup> Composition and properties depend upon dilution. Single layer deposit properties depend upon base metal and/or build-up material.

<p>IMPORTANT: SPECIAL VENTILATION AND/OR EXHAUST REQUIRED</p> <p>Fumes from the normal use of some welding products can contain significant quantities of components - such as chromium and manganese - which can lower the 5.0 mg/m<sup>3</sup> maximum exposure guideline for general welding fume.</p> <p>BEFORE USE, READ AND UNDERSTAND THE SAFETY DATA SHEET (SDS) FOR THIS PRODUCT AND SPECIFIC INFORMATION PRINTED ON THE PRODUCT CONTAINER.</p>
--

# LINCORE® 65-0

Severe Abrasion

## KEY FEATURES

- Deposits include higher carbon and chrome levels than Lincore® 60-0
- Recommended for use on wear plate, coal pulverizer rolls, earth engaging tools, and on slurry pipe and elbows
- To be used on carbon, low alloy, manganese, stainless steels and cast iron
- Limited to four layers

## TYPICAL APPLICATIONS

- Screw augers
- Ore chutes and wearplates
- Crusher rolls
- Ripper teeth

## WELDING POSITIONS

Flat & Horizontal

## DIAMETERS / PACKAGING

Diameter in (mm)	50 lb (22.7 kg) Coil	500 lb (227 kg) Speed-Feed® Drum
1/8 (3.2)	ED026076	ED026082
7/64 (2.8)	ED026077	ED026083

## MECHANICAL PROPERTIES<sup>(1)</sup>

Rockwell Hardness (R <sub>c</sub> )		
1 Layer	2 Layers	4 Layers
57	60	64

## DEPOSIT COMPOSITION<sup>(1)</sup>

	%C	%Mn	%Si	%Cr
<b>1 Layer</b>	3.7	1.3	0.7	19.9
<b>2 Layers</b>	4.9	1.6	1.0	26.2
<b>4 Layers</b>	5.7	1.8	1.1	30.8

## TYPICAL OPERATING PROCEDURES

Diameter, Polarity ESO - in (mm)	Wire Feed Speed m/min (in/min)	Voltage (Volts)	Approx. Current (Amps)	Deposition Rate kg/hr (lb/hr)
<b>7/64 in (2.8 mm), DC+</b> 1 1/8 (30)	2.5 (100)	28	280	4.4 (9.6)
	5.1 (200)	31	420	8.9 (19.7)
	7.6 (300)	33	500	13.5 (29.8)
<b>1/8 in (3.2 mm), DC+</b> 1 1/2 (37)	2.5 (100)	27	375	6.4 (14.0)
	4.4 (175)	29	500	11.4 (25.1)
	6.7 (265)	31	625	16.7 (36.7)

4 layers of Lincore 65-0	
Condition	Rockwell Hardness C
As-Welded	63
Aged at 1200°F (650°C) for 2 hours	56
Aged at 1400°F (760°C) for 2 hours	54

<sup>(1)</sup> Composition and properties depend upon dilution. Single layer deposit properties depend upon base metal and/or build-up material.

NOTE: Postweld heat treatment up to 1400°F (760°C) will not affect abrasion resistance very significantly, but will affect hardness to some extent. Typical results are shown above.

<p>IMPORTANT: SPECIAL VENTILATION AND/OR EXHAUST REQUIRED</p> <p>Fumes from the normal use of some welding products can contain significant quantities of components - such as chromium and manganese - which can lower the 5.0 mg/m<sup>3</sup> maximum exposure guideline for general welding fume.</p> <p>BEFORE USE, READ AND UNDERSTAND THE SAFETY DATA SHEET (SDS) FOR THIS PRODUCT AND SPECIFIC INFORMATION PRINTED ON THE PRODUCT CONTAINER.</p>
--

# LINCORE® 70-0

Severe Abrasion

## KEY FEATURES

- Exceptional wear resistance with deposits that last approximately 2-3 times longer than most chrome carbide and complex carbide alloys, especially in wet abrasion applications
- Maintains high hardness after exposure to elevated temperatures up to 1000°F (538°C)
- Best suited for carbon and low alloy steels. Not compatible for austenitic stainless or austenitic manganese steels). Limited to a maximum of two layers
- Great for high value applications where downtime is costly or replacement parts are expensive

## WELDING POSITIONS

Flat & Horizontal Only

## TYPICAL APPLICATIONS

- Wearplate
- Crusher Rolls
- Ore Chutes
- Screw Augers

## DIAMETERS / PACKAGING

Diameter in (mm)	10 lb (4.5 kg) Spool	33 lb (15 kg) Spool	50 lb (22.7 kg) Coil
0.045 (1.1)	ED037264	ED037265	-
1/16 (1.6)	ED037266	ED037267	-
5/64 (2.0)	-	ED037268	-
7/64 (2.8)	-	-	ED037269

## MECHANICAL PROPERTIES<sup>(1)</sup>

Rockwell Hardness (R <sub>c</sub> )	Wear Resistance (ASTM G65-04 Procedure A)
67-70	0.13 g mass loss

## DEPOSIT COMPOSITION<sup>(1)</sup>

% Fe	% C	% Cr	% B	% Nb	% Al	% Mn	% Si
Balance	<3	<18	<6	<10	<5	<2	<2

<sup>(1)</sup> Composition and properties depend on dilution. Single layer deposit properties depend upon base metal and/or build-up material.

## TYPICAL OPERATING PROCEDURES

Diameter, Polarity ESO – in (mm)	Current (Amps)	Voltage (Volts)	Wire Feed Speed m/min (ipm)	Deposition Rate lb/hr
0.045 in (1.1 mm), DC+ 3/4-1 (20) FCAW-S	~ 135	24	7.0 (275)	6.5
1/16 in (1.6 mm), DC+ 3/4-1 (20) FCAW-S	~ 220	24	7.0 (275)	10.5
5/64 in (2.0 mm) DC+ 3/4-1 (20) FCAW-S	~ 300	25	7.0 (275)	–
7/64 in (2.8 mm) DC+ 3/4-1.75 (40) FCAW-S	~ 450	26	5.7 (225)	–

IMPORTANT: SPECIAL VENTILATION AND/OR EXHAUST REQUIRED

Fumes from the normal use of some welding products can contain significant quantities of components - such as chromium and manganese - which can lower the 5.0 mg/m<sup>3</sup> maximum exposure guideline for general welding fume.

BEFORE USE, READ AND UNDERSTAND THE SAFETY DATA SHEET (SDS) FOR THIS PRODUCT AND SPECIFIC INFORMATION PRINTED ON THE PRODUCT CONTAINER.



# LINCORE® BCR-O

Severe Abrasion

## KEY FEATURES

- Strengthened carbide matrix provides overall harder deposit
- Enhanced puddle fluidity to provide excellent tie in
- Low spatter and virtually no slag clean up required
- Limited to 4 layers max

## TYPICAL APPLICATIONS

- Wearplate
- Crusher rolls
- Ore Chutes
- Screw augers

## WELDING POSITIONS

Flat & Horizontal Only

## DIAMETERS / PACKAGING

Diameter in (mm)	50 lb (22.7 kg) Coil	500 lb (227 kg) Speed-Feed® Drum
1/8 (3.2)	ED034487	ED034488

## MECHANICAL PROPERTIES<sup>(1)</sup>

Rockwell Hardness (R <sub>c</sub> )
58-65

## DEPOSIT COMPOSITION<sup>(1)</sup>

%Fe	%C	%Cr	%B	%Mo	%Mn	%Si	%Al
Balance	<10	<35	<5	<2	<5	<2	<1

## TYPICAL OPERATING PROCEDURES

Diameter, Polarity ESO - in (mm)	Wire Feed Speed m/min (ipm)	Voltage (Volts)	Approx. Current (Amps)
1/8 in (3.2 mm), DC+ 1 1/2 (38) FCAW-S	4.8 (190)	29	~500

<sup>(1)</sup> Composition and properties depend upon dilution. Single layer deposit properties depend upon base metal and/or build-up material.

IMPORTANT: SPECIAL VENTILATION AND/OR EXHAUST REQUIRED

Fumes from the normal use of some welding products can contain significant quantities of components - such as chromium and manganese - which can lower the 5.0 mg/m<sup>3</sup> maximum exposure guideline for general welding fume.

BEFORE USE, READ AND UNDERSTAND THE SAFETY DATA SHEET (SDS) FOR THIS PRODUCT AND SPECIFIC INFORMATION PRINTED ON THE PRODUCT CONTAINER.

# LINCORE® BNB-O

Severe Abrasion

## KEY FEATURES

- Better wear characteristics with formation of multiple carbide deposit
- Strengthened carbide matrix provides overall harder deposit
- Enhanced puddle fluidity to provide excellent tie in
- Low spatter and virtually no slag clean up required
- Limited to 4 layers max

## TYPICAL APPLICATIONS

- Wearplate
- Crusher rolls
- Ore Chutes
- Screw augers

## WELDING POSITIONS

Flat & Horizontal Only

## DIAMETERS / PACKAGING

Diameter in (mm)	50 lb (22.7 kg) Coil	500 lb (227 kg) Speed-Feed® Drum
1/8 (3.2)	ED034483	ED034493

## MECHANICAL PROPERTIES<sup>(1)</sup>

Rockwell Hardness (R <sub>c</sub> )
58-65

## DEPOSIT COMPOSITION<sup>(1)</sup>

%Fe	%C	%Cr	%B	%Mo	%Mn	%Si	%Nb	%Al
Balance	<10	<35	<5	<2	<5	<2	<2	<1

## TYPICAL OPERATING PROCEDURES

Diameter, Polarity ESO - in (mm)	Wire Feed Speed m/min (ipm)	Voltage (Volts)	Approx. Current (Amps)
1/8 in (3.2 mm), DC+ 1 1/2 (38) FCAW-S	4.8 (190)	29	~500

<sup>(1)</sup> Composition and properties depend upon dilution. Single layer deposit properties depend upon base metal and/or build-up material.

IMPORTANT: SPECIAL VENTILATION AND/OR EXHAUST REQUIRED

Fumes from the normal use of some welding products can contain significant quantities of components - such as chromium and manganese - which can lower the 5.0 mg/m<sup>3</sup> maximum exposure guideline for general welding fume.

BEFORE USE, READ AND UNDERSTAND THE SAFETY DATA SHEET (SDS) FOR THIS PRODUCT AND SPECIFIC INFORMATION PRINTED ON THE PRODUCT CONTAINER.

# LINCORE® GATORBACK-O

Severe Abrasion

## KEY FEATURES

- Strengthened carbide matrix provides overall harder deposit
- Enhanced puddle fluidity to provide excellent tie in
- Low spatter and virtually no slag clean up required
- Limited to 4 layers max

## TYPICAL APPLICATIONS

- Wearplate
- Crusher rolls
- Ore Chutes

## WELDING POSITIONS

Flat & Horizontal Only

## DIAMETERS / PACKAGING

Diameter in (mm)	50 lb (22.7 kg) Coil	500 lb (227 kg) Speed-Feed® Drum
1/8 (3.2)	ED034950	ED034951

## MECHANICAL PROPERTIES<sup>(1)</sup>

Rockwell Hardness (R <sub>c</sub> )
58-65

## DEPOSIT COMPOSITION<sup>(1)</sup>

%Fe	%C	%Cr	%B	%Mo	%Mn	%Si	%Nb	%Al
Balance	<10	<35	<5	<2	<5	<2	<10	<1

## TYPICAL OPERATING PROCEDURES

Diameter, Polarity ESO - in (mm)	Wire Feed Speed m/min (ipm)	Voltage (Volts)	Approx. Current (Amps)
1/8 in (3.2 mm), DC+ 1 1/2 (38) FCAW-S	4.8 (190)	29	~500

<sup>(1)</sup> Composition and properties depend upon dilution. Single layer deposit properties depend upon base metal and/or build-up material.

IMPORTANT: SPECIAL VENTILATION AND/OR EXHAUST REQUIRED

Fumes from the normal use of some welding products can contain significant quantities of components - such as chromium and manganese - which can lower the 5.0 mg/m<sup>3</sup> maximum exposure guideline for general welding fume.

BEFORE USE, READ AND UNDERSTAND THE SAFETY DATA SHEET (SDS) FOR THIS PRODUCT AND SPECIFIC INFORMATION PRINTED ON THE PRODUCT CONTAINER.

# LINCORE® GATORBACK-S

Severe Abrasion

## KEY FEATURES

- Better wear characteristics with formation of multiple carbide deposit
- Resists spalling with ductile carbide eutectic matrix
- Low spatter and virtually no slag clean up required
- Limited to 4 layers max

## TYPICAL APPLICATIONS

- Wearplate
- Crusher rolls
- Ore Chutes

## WELDING POSITIONS

Flat & Horizontal Only

## DIAMETERS / PACKAGING

Diameter in (mm)	50 lb (22.7 kg) Coil	500 lb (227 kg) Speed-Feed® Drum
1/8 (3.2)	ED034799	ED034798

## MECHANICAL PROPERTIES<sup>(1)</sup>

Rockwell Hardness (R <sub>c</sub> )
58-65

## DEPOSIT COMPOSITION<sup>(1)</sup>

%Fe	%C	%Cr	%B	%Mo	%Mn	%Si	%Nb	%Al
Balance	<10	<35	<5	<2	<5	<2	<10	<1

## TYPICAL OPERATING PROCEDURES

Diameter, Polarity ESO - in (mm)	Wire Feed Speed m/min (ipm)	Voltage (Volts)	Approx. Current (Amps)
1/8 in (3.2 mm), DC+ 1 1/2 (38) FCAW-S with Lincolnweld® 801® or 802® Flux	3.8 (150)	29	~600

<sup>(1)</sup> Composition and properties depend upon dilution. Single layer deposit properties depend upon base metal and/or build-up material.

IMPORTANT: SPECIAL VENTILATION AND/OR EXHAUST REQUIRED

Fumes from the normal use of some welding products can contain significant quantities of components - such as chromium and manganese - which can lower the 5.0 mg/m<sup>3</sup> maximum exposure guideline for general welding fume.

BEFORE USE, READ AND UNDERSTAND THE SAFETY DATA SHEET (SDS) FOR THIS PRODUCT AND SPECIFIC INFORMATION PRINTED ON THE PRODUCT CONTAINER.

# LINCORE® ULTRA R

Severe Abrasion

## KEY FEATURES

- Borocarbide enhanced microstructure. Provides the same wear from multiple layers of chrome carbide in one layer
- Consistently high hardness across the entire bead, all the way to the substrate
- Low spatter and virtually no slag clean up required
- Limited to 2 layers max

## TYPICAL APPLICATIONS

- Wearplate
- Crusher rolls
- Ore Chutes

## WELDING POSITIONS

Flat & Horizontal Only

## DIAMETERS / PACKAGING

Diameter in (mm)	50 lb (22.7 kg) Coil	500 lb (227 kg) Speed-Feed® Drum
1/8 (3.2)	ED035367	ED035368

## MECHANICAL PROPERTIES<sup>(1)</sup>

Rockwell Hardness (R <sub>c</sub> )
68-70

## DEPOSIT COMPOSITION<sup>(1)</sup>

%Fe	%C	%Cr	%B	%Mo	%Mn	%Si	%Al
Balance	<10	<35	<5	<2	<5	<2	<1

## TYPICAL OPERATING PROCEDURES

Diameter, Polarity ESO - in (mm)	Wire Feed Speed m/min (ipm)	Voltage (Volts)	Approx. Current (Amps)
1/8 in (3.2 mm), DC+ 1 1/2 (38) FCAW-S	4.8 (190)	29	~500

<sup>(1)</sup> Composition and properties depend upon dilution. Single layer deposit properties depend upon base metal and/or build-up material.

<p>IMPORTANT: SPECIAL VENTILATION AND/OR EXHAUST REQUIRED</p> <p>Fumes from the normal use of some welding products can contain significant quantities of components - such as chromium and manganese - which can lower the 5.0 mg/m<sup>3</sup> maximum exposure guideline for general welding fume.</p> <p>BEFORE USE, READ AND UNDERSTAND THE SAFETY DATA SHEET (SDS) FOR THIS PRODUCT AND SPECIFIC INFORMATION PRINTED ON THE PRODUCT CONTAINER.</p>
--

# LINCORE® TICORE

Severe Abrasion

## KEY FEATURES

- Better wear characteristics than martensitic only deposit
- Low spatter and easy slag cleanup
- Deposits do not check crack
- Limited to 4 layers max

## TYPICAL APPLICATIONS

- Wearplate
- Crusher rolls
- Ore Chutes

## WELDING POSITIONS

Flat & Horizontal Only

## DIAMETERS / PACKAGING

Diameter in (mm)	25 lb (11.3 kg) Coil
5/64 (2.0)	ED035628

## MECHANICAL PROPERTIES<sup>(1)</sup>

Rockwell Hardness (R <sub>c</sub> )
57-64

## DEPOSIT COMPOSITION<sup>(1)</sup>

%Fe	%C	%Cr	%V	%Mo	%Mn	%Si	%Ti	%Al
Balance	<5	<15	<2	<5	<5	<5	<20	<1

## TYPICAL OPERATING PROCEDURES

Diameter, Polarity ESO - in (mm)	Wire Feed Speed m/min (ipm)	Voltage (Volts)	Approx. Current (Amps)
5/64 in (2.0 mm), DC+ 1 1/2 (38) FCAW-S	5.1 (200)	27	~260

<sup>(1)</sup> Composition and properties depend upon dilution. Single layer deposit properties depend upon base metal and/or build-up material.

<p>IMPORTANT: SPECIAL VENTILATION AND/OR EXHAUST REQUIRED</p> <p>Fumes from the normal use of some welding products can contain significant quantities of components - such as chromium and manganese - which can lower the 5.0 mg/m<sup>3</sup> maximum exposure guideline for general welding fume.</p> <p>BEFORE USE, READ AND UNDERSTAND THE SAFETY DATA SHEET (SDS) FOR THIS PRODUCT AND SPECIFIC INFORMATION PRINTED ON THE PRODUCT CONTAINER.</p>
--

# WEARTECH® SHS® 9800U

Severe Abrasion

## KEY FEATURES

- Exceptional resistance to severe sliding abrasion
- Provides longer lasting wear life than most chrome carbide and complex carbide alloys
- Improved impact resistance results from complex borocarbide phases surrounded by ductile phases that form during welding
- Limited to 2 layers max

## TYPICAL APPLICATIONS

- Wearplate
- ID Clad Pipe
- Slurry Transport
- Crusher Rolls
- Ore Chutes
- Screw Augers

## DIAMETERS / PACKAGING

Diameter in (mm)	33 lb (15 kg) Spool PLW	50 lb (22.7 kg) Fiber Spool PLW	55 lb (25 kg) Coil	400 lb (181 kg) Speed Feed Drum	500 lb (227 kg) Speed Feed Drum
0.045 (1.1)	W9800-120X15				
1/16 (1.6)	W9800-160X15				
3/32 (2.4)		W9800-160X23		W9800-160BULK	
7/64 (2.8)			W9800-240X25 W9800-280X25		W9800-240BULK W9800-280BULK

## MECHANICAL PROPERTIES<sup>(1)</sup>

Rockwell Hardness (R <sub>c</sub> )	Wear Resistance
68-71	ASTM G65-04 Procedure A, 0.12 g mass loss

## DEPOSIT COMPOSITION<sup>(1)</sup>

%Fe	%C	%Cr	%B	%Mo	%Nb	%Mn	%Si
Balance	<2	<21	<7	<6	<6	<2	<2

## TYPICAL OPERATING PROCEDURES

Diameter, Polarity ESO - in (mm)	Current (Amps)	Voltage (Volts)	Wire Feed Speed m/min (ipm)	Shielding Gas	Flow Rate (cft)
<b>0.045 in (1.1mm), DC+</b> ½ - ¾ (15) GMAW-C ¾ - 1 (20) FCAW-S	~135	24	7.0 (275)	75 Ar - 25 CO <sub>2</sub>	35 - 45
<b>1/16 in (1.6mm), DC+</b> ½ - ¾ (15) GMAW-C ¾ - 1 (20) FCAW-S	~220	24	7.0 (275)	75 Ar - 25 CO <sub>2</sub>	45 - 60
<b>3/32 in (2.4mm), DC+</b> ¾ - 1 (20) GMAW-C ¾ - 1.25 (25) FCAW-S	~375	25	7.0 (275)	75 Ar - 25 CO <sub>2</sub>	55 - 70
<b>7/64 in (2.8mm), DC+</b> ¾ - 1 (20) GMAW-C 1 - 1½ (40) FCAW-S	~450	26	5.7 (225)	75 Ar - 25 CO <sub>2</sub>	60 - 80

<sup>(1)</sup> Composition and properties depend upon dilution. Single layer deposit properties depend upon base metal and/or build-up material.

<p>IMPORTANT: SPECIAL VENTILATION AND/OR EXHAUST REQUIRED</p> <p>Fumes from the normal use of some welding products can contain significant quantities of components - such as chromium and manganese - which can lower the 5.0 mg/m<sup>3</sup> maximum exposure guideline for general welding fume.</p> <p>BEFORE USE, READ AND UNDERSTAND THE SAFETY DATA SHEET (SDS) FOR THIS PRODUCT AND SPECIFIC INFORMATION PRINTED ON THE PRODUCT CONTAINER.</p>
--

# WEARTECH® SHS® 9700U

Severe Abrasion

## KEY FEATURES

- Lower cost while maintaining near nanoscale (submicron) microstructure
- Provides exceptional wear resistance lasting significantly longer than most chrome carbide and complex carbide alloys
- Maintains high hardness after exposure to elevated temperature
- Limited to 2 layers max

## TYPICAL APPLICATIONS

- Wearplate
- Crusher Rolls
- Ore Chutes
- Screw Augers

## DIAMETERS / PACKAGING

Diameter in (mm)	33 lb (15 kg) Spool PLW	55 lb (25 kg) Coil	500 lb (227 kg) Speed Feed Drum
0.045 (1.1)	W9700-120X15		
1/16 (1.6)	ED037276 (W9700-160X15)		
3/32 (2.4)		W9700-240X25	
7/64 (2.8)		W9700-280X25	W9700-280BULK

## MECHANICAL PROPERTIES<sup>(1)</sup>

Rockwell Hardness (R <sub>c</sub> )	Wear Resistance
67-70	ASTM G65-04 Procedure A, 0.13 g mass loss

## DEPOSIT COMPOSITION<sup>(1)</sup>

%Fe	%C	%Cr	%B	%Nb	%Al	%Mn	%Si
Balance	<3	<18	<6	<10	<5	<2	<2

## TYPICAL OPERATING PROCEDURES

Diameter, Polarity ESO - in (mm)	Current (Amps)	Voltage (Volts)	Wire Feed Speed m/min (ipm)	Shielding Gas	Flow Rate (cfh)
<b>0.045 in (1.1mm), DC+</b> ½ - ¾ (15) GMAW-C ¾ - 1 (20) FCAW-S	~135	24	7.0 (275)	75 Ar – 25 CO <sub>2</sub>	35 – 45
<b>1/16 in (1.6mm), DC+</b> ½ - ¾ (15) GMAW-C ¾ - 1 (20) FCAW-S	~220	24	7.0 (275)	75 Ar – 25 CO <sub>2</sub>	45 – 60
<b>3/32 in (2.4mm), DC+</b> ¾ - 1 (20) GMAW-C ¾ - 1.25 (25) FCAW-S	~375	25	7.0 (275)	75 Ar – 25 CO <sub>2</sub>	55 – 70
<b>7/64 in (2.8mm), DC+</b> ¾ - 1 (20) GMAW-C 1 - 1¼ (40) FCAW-S	~450	26	5.7 (225)	75 Ar – 25 CO <sub>2</sub>	60 – 80

<sup>(1)</sup> Composition and properties depend upon dilution. Single layer deposit properties depend upon base metal and/or build-up material.

<p>IMPORTANT: SPECIAL VENTILATION AND/OR EXHAUST REQUIRED</p> <p>Fumes from the normal use of some welding products can contain significant quantities of components - such as chromium and manganese - which can lower the 5.0 mg/m<sup>3</sup> maximum exposure guideline for general welding fume.</p> <p>BEFORE USE, READ AND UNDERSTAND THE SAFETY DATA SHEET (SDS) FOR THIS PRODUCT AND SPECIFIC INFORMATION PRINTED ON THE PRODUCT CONTAINER.</p>
--



# WEARTECH® SHS® 9192U

Severe Abrasion

## KEY FEATURES

- Extreme resistance to abrasion
- Maintains high hardness after exposure to high temperatures
- Provides exceptional uniformity of hardness and wear performance across a range of service environments
- Limited to 2 layers max

## TYPICAL APPLICATIONS

- Wearplate
- Crusher Rolls
- Ore Chutes
- Screw Augers

## DIAMETERS / PACKAGING

Diameter in (mm)	25 lb (11.3 kg) Spool PLW	33 lb (15 kg) Spool PLW	55 lb (25 kg) Coil	400 lb (181 kg) Speed Feed® Drum
0.045 (1.1)	W9192-120X15	ED037277 (W9192-160X15)	W9192-240X25 W9192-280X25	ED037278 (W9192-160BULK)
1/16 (1.6)				
3/32 (2.4)				
7/64 (2.8)				

## MECHANICAL PROPERTIES<sup>(1)</sup>

Rockwell Hardness (R <sub>c</sub> )	Wear Resistance
69-72	ASTM G65-04 Procedure A, 0.10 g mass loss

## DEPOSIT COMPOSITION<sup>(1)</sup>

%Fe	%C	%Cr	%W	%B	%Mo	%Nb	%Mn	%Si	%Al
Balance	<5	<20	<10	<5	<10	<10	<5	<2	<5

## TYPICAL OPERATING PROCEDURES

Diameter, Polarity ESO - in (mm)	Current (Amps)	Voltage (Volts)	Wire Feed Speed m/min (ipm)	Shielding Gas	Flow Rate (cfh)
<b>0.045 in (1.1mm), DC+</b> ½ - ¾ (15) GMAW-C ¾ - 1 (20) FCAW-S	~135	24	7.0 (275)	75 Ar - 25 CO <sub>2</sub>	35 - 45
<b>1/16 in (1.6mm), DC+</b> ½ - ¾ (15) GMAW-C ¾ - 1 (20) FCAW-S	~220	24	7.0 (275)	75 Ar - 25 CO <sub>2</sub>	45 - 60
<b>3/32 in (2.4mm), DC+</b> ¾ - 1 (20) GMAW-C ¾ - 1.25 (25) FCAW-S	~375	25	7.0 (275)	75 Ar - 25 CO <sub>2</sub>	55 - 70
<b>7/64 in (2.8mm), DC+</b> ¾ - 1 (20) GMAW-C 1 - 1½ (40) FCAW-S	~450	26	5.7 (225)	75 Ar - 25 CO <sub>2</sub>	60 - 80

<sup>(1)</sup> Composition and properties depend upon dilution. Single layer deposit properties depend upon base metal and/or build-up material.

<p>IMPORTANT: SPECIAL VENTILATION AND/OR EXHAUST REQUIRED</p> <p>Fumes from the normal use of some welding products can contain significant quantities of components - such as chromium and manganese - which can lower the 5.0 mg/m<sup>3</sup> maximum exposure guideline for general welding fume.</p> <p>BEFORE USE, READ AND UNDERSTAND THE SAFETY DATA SHEET (SDS) FOR THIS PRODUCT AND SPECIFIC INFORMATION PRINTED ON THE PRODUCT CONTAINER.</p>
--

# WEARTECH® SHS® 9500U

Severe Abrasion

## KEY FEATURES

- Minimal cracking when applied to plain carbon and alloy steels
- Lower cost while maintaining near nanoscale (submicron) microstructure
- High resistance to abrasion and galling
- Limited to 2 layers max

## TYPICAL APPLICATIONS

- Wearplate
- Crusher Rolls
- Ore Chutes
- Screw Augers

## DIAMETERS / PACKAGING

Diameter in (mm)	33 lb (15 kg) Spool PLW	45 lb (20 kg) Fiber Spool PLW
0.045 (1.1) 1/16 (1.6)	W9500-120X15 W9500-160X15	ED037275 (W9500-160X15)

## MECHANICAL PROPERTIES<sup>(1)</sup>

Rockwell Hardness (R <sub>c</sub> )	Wear Resistance
58-62	ASTM G65-04 Procedure A, 0.22 g mass loss

## DEPOSIT COMPOSITION<sup>(1)</sup>

%Fe	%C	%Cr	%B	%Nb	%Mn	%Si
Balance	<3	<10	<6	<9	<5	<2

## TYPICAL OPERATING PROCEDURES

Diameter, Polarity ESO - in (mm)	Current (Amps)	Voltage (Volts)	Wire Feed Speed m/min (ipm)	Shielding Gas	Flow Rate (cfh)
<b>0.045 in (1.1mm), DC+</b> ½ - ¾ (15) GMAW-C ¾ - 1 (20) FCAW-S	~135	24	7.0 (275)	75 Ar - 25 CO <sub>2</sub>	35 - 45
<b>1/16 in (1.6mm), DC+</b> ½ - ¾ (15) GMAW-C ¾ - 1 (20) FCAW-S	~220	24	7.0 (275)	75 Ar - 25 CO <sub>2</sub>	45 - 60
<b>3/32 in (2.4mm), DC+</b> ¾ - 1 (20) GMAW-C ¾ - 1.25 (25) FCAW-S	~375	25	7.0 (275)	75 Ar - 25 CO <sub>2</sub>	55 - 70
<b>7/64 in (2.8mm), DC+</b> ¾ - 1 (20) GMAW-C 1 - 1½ (40) FCAW-S	~450	26	5.7 (225)	75 Ar - 25 CO <sub>2</sub>	60 - 80

<sup>(1)</sup> Composition and properties depend upon dilution. Single layer deposit properties depend upon base metal and/or build-up material.

IMPORTANT: SPECIAL VENTILATION AND/OR EXHAUST REQUIRED

Fumes from the normal use of some welding products can contain significant quantities of components - such as chromium and manganese - which can lower the 5.0 mg/m<sup>3</sup> maximum exposure guideline for general welding fume.

BEFORE USE, READ AND UNDERSTAND THE SAFETY DATA SHEET (SDS) FOR THIS PRODUCT AND SPECIFIC INFORMATION PRINTED ON THE PRODUCT CONTAINER.

# LINCOLNWELD® A-96-S

Hardfacing ▪ Flux

## KEY FEATURES

- Modified Type 420 stainless deposit with a carbon content near the high side for as-welded hardness
- Designed to produce a weld deposit with 13% chromium, 0.23% carbon when proper procedures are followed

## TYPICAL APPLICATIONS

- Use with Lincolnweld® L-60 mild steel wire for hardfacing

## PACKAGING

60 lb (27.2 kg) Plastic Bag

ED031860

## DIAMETERS / PACKAGING

Diameter - in (mm)	60 lb (27.2 kg) Plastic Bag
N/A	ED031860

*NOTE: Deposit carbon, alloy content and hardness depend upon the ratio of flux melted to wire melted. High voltage promotes high carbon and alloy contents, while low voltage promotes lower carbon and alloy content.*

IMPORTANT: SPECIAL VENTILATION AND/OR EXHAUST REQUIRED

Fumes from the normal use of some welding products can contain significant quantities of components - such as chromium and manganese - which can lower the 5.0 mg/m<sup>3</sup> maximum exposure guideline for general welding fume.

BEFORE USE, READ AND UNDERSTAND THE SAFETY DATA SHEET (SDS) FOR THIS PRODUCT AND SPECIFIC INFORMATION PRINTED ON THE PRODUCT CONTAINER.

# LINCOLNWELD® H-535™

Hardfacing ▪ Flux

## KEY FEATURES

- Produces a deposit with good abrasion resistance, allows some machinability
- Low carbon martensitic deposit
- Hardness range is 24-45 Rockwell C (R<sub>C</sub>), depending upon the actual welding procedure used

## TYPICAL APPLICATIONS

- Use with Lincolnweld® L-60 mild steel wire for hardfacing

## PACKAGING

50 lb (22.7 kg) Paper Bag

ED027865

## DIAMETERS / PACKAGING

Diameter - in (mm)	50 lb (22.7 kg) Paper Bag
N/A	ED027865

*NOTE: Deposit carbon, alloy content and hardness depend upon the ratio of flux melted to wire melted. High voltage promotes high carbon and alloy contents, while low voltage promotes lower carbon and alloy content.*

IMPORTANT: SPECIAL VENTILATION AND/OR EXHAUST REQUIRED

Fumes from the normal use of some welding products can contain significant quantities of components - such as chromium and manganese - which can lower the 5.0 mg/m<sup>3</sup> maximum exposure guideline for general welding fume.

BEFORE USE, READ AND UNDERSTAND THE SAFETY DATA SHEET (SDS) FOR THIS PRODUCT AND SPECIFIC INFORMATION PRINTED ON THE PRODUCT CONTAINER.

# LINCOLNWELD® H-560™

Hardfacing ▪ EN 760 – S A Z 3

## KEY FEATURES

- High alloy flux depositing primary carbides in a martensitic matrix
- Excellent material for severe abrasion applications
- Resistance to abrasion is 50 to 60 times that of plain carbon steel

## TYPICAL APPLICATIONS

- Use with Lincolnweld® L-60 mild steel wire for hardfacing

## PACKAGING

100 lb (45.4 kg) Paper Bag

ED010345

## DIAMETERS / PACKAGING

Diameter in (mm)	60 lb (27.2 kg) Paper Bag
N/A	ED036785

*NOTE: Deposit carbon, alloy content and hardness depend upon the ratio of flux melted to wire melted. High voltage promotes high carbon and alloy contents, while low voltage promotes lower carbon and alloy content.*

IMPORTANT: SPECIAL VENTILATION AND/OR EXHAUST REQUIRED

Fumes from the normal use of some welding products can contain significant quantities of components - such as chromium and manganese - which can lower the 5.0 mg/m<sup>3</sup> maximum exposure guideline for general welding fume.

BEFORE USE, READ AND UNDERSTAND THE SAFETY DATA SHEET (SDS) FOR THIS PRODUCT AND SPECIFIC INFORMATION PRINTED ON THE PRODUCT CONTAINER.

# LINCOLNWELD® 801®

Neutral Flux ■ EN 760 – S A FB 1; EN 760 – S A FB 2

## KEY FEATURES

- Provides smooth beads and excellent slag removal
- Fast-freezing

## TYPICAL APPLICATIONS

- Hardfacing
- Use with Lincore® 20, 30-S, 35-S, 40-S, 42-S, 4130, 8620, 410, 410NiMo, 420 and 96S

## PACKAGING

50 lb (22.7 kg) Paper Bag	ED019588
550 lb (249 kg) Drum	ED023403
3000 lb (1361 kg) Bulk Bag	EDS30786

## DIAMETERS / PACKAGING

Diameter - in (mm)	50 lb (22.7 kg) Paper Bag	550 lb (249 kg) Drum	3000 lb (1361 kg) Bulk Bag
N/A	ED019588	ED023403	EDS30786

*NOTE: Deposit carbon, alloy content and hardness depend upon the ratio of flux melted to wire melted. High voltage promotes high carbon and alloy contents, while low voltage promotes lower carbon and alloy content.*

IMPORTANT: SPECIAL VENTILATION AND/OR EXHAUST REQUIRED

Fumes from the normal use of some welding products can contain significant quantities of components - such as chromium and manganese - which can lower the 5.0 mg/m<sup>3</sup> maximum exposure guideline for general welding fume.

BEFORE USE, READ AND UNDERSTAND THE SAFETY DATA SHEET (SDS) FOR THIS PRODUCT AND SPECIFIC INFORMATION PRINTED ON THE PRODUCT CONTAINER.

# LINCOLNWELD® 802®

Neutral Flux ■ EN 760 – S A CS 1; EN 760 – S A CS 2

## KEY FEATURES

- Excellent hot slag removal with wire containing niobium, vanadium or very high chromium levels

## TYPICAL APPLICATIONS

- Hardfacing
- Use with Lincore® 102W, 423Cr, 423N, 414N, and 102HC

## PACKAGING

50 lb (22.7 kg) Paper Bag	ED032800
450 lb (204 kg) Drum	ED023365
2700 lb (1225 kg) Bulk Bag	EDS30787

## DIAMETERS / PACKAGING

Diameter - in (mm)	50 lb (22.7 kg) Paper Bag	450 lb (204 kg) Drum	2700 lb (1225 kg) Bulk Bag
N/A	ED032800	ED023365	EDS30787

*NOTE: Deposit carbon, alloy content and hardness depend upon the ratio of flux melted to wire melted. High voltage promotes high carbon and alloy contents, while low voltage promotes lower carbon and alloy content.*

IMPORTANT: SPECIAL VENTILATION AND/OR EXHAUST REQUIRED

Fumes from the normal use of some welding products can contain significant quantities of components - such as chromium and manganese - which can lower the 5.0 mg/m<sup>3</sup> maximum exposure guideline for general welding fume.

BEFORE USE, READ AND UNDERSTAND THE SAFETY DATA SHEET (SDS) FOR THIS PRODUCT AND SPECIFIC INFORMATION PRINTED ON THE PRODUCT CONTAINER.

# WEARTECH® GUARDIAN® HB

## Severe Abrasion

### KEY FEATURES

- Industry leading casing wear protection
- High tool joint protection in casing
- Superior spalling resistance
- Weldable with or without gas shielding

### TYPICAL APPLICATIONS

- Hardbanding

### DIAMETERS / PACKAGING

Diameter in (mm)	33 lb (15 kg) Spool PLW
1/16 (1.6)	W7272-160X15

### MECHANICAL PROPERTIES<sup>(1)</sup>

Rockwell Hardness (R <sub>c</sub> )	Wear Resistance
57-59	ASTM G65-04 Procedure A 0.32 g mass loss

### DEPOSIT COMPOSITION<sup>(1)</sup>

%Fe	%C	%Cr	%B	%Mo	%W	%Ti	%Mn	%Si
Balance	<2	<20	<5	<4	<6	<3	<4	<2

### TYPICAL OPERATING PROCEDURES

Diameter, Polarity ESO - in (mm)	Current (Amps)	Voltage (Volts)	Wire Feed Speed m/min (ipm)	Shielding Gas	Flow Rate (cft)
<b>1/16 in (1.6mm), DC+</b> ½ - ¾ (15) GMAW-C ¾ - 1 (20) FCAW-S	-220	24	7.0 (275)	75 Ar – 25 CO <sub>2</sub>	45-60

<sup>(1)</sup>Two layers

IMPORTANT: SPECIAL VENTILATION AND/OR EXHAUST REQUIRED

Fumes from the normal use of some welding products can contain significant quantities of components - such as chromium and manganese - which can lower the 5.0 mg/m<sup>3</sup> maximum exposure guideline for general welding fume.

BEFORE USE, READ AND UNDERSTAND THE SAFETY DATA SHEET (SDS) FOR THIS PRODUCT AND SPECIFIC INFORMATION PRINTED ON THE PRODUCT CONTAINER.

# WEARTECH® GUARDIAN® CF

## Severe Abrasion

### KEY FEATURES

- Industry leading casing wear protection
- Exceptional tool wear life
- Applicable over other hardband materials
- Weldable with or without gas shielding

### TYPICAL APPLICATIONS

- Hardbanding

### SHIELDING GAS (for GMAW-C)

98%Ar/2%O<sub>2</sub> or Ar/CO<sub>2</sub> blends

No shielding gas is required for FCAW-S applications

### DIAMETERS / PACKAGING

Diameter in (mm)	33 lb (15 kg) Spool PLW	45 lb (20.4 kg) Fiber Spool PLW
1/16 (1.6)	W9500-160X15	ED037279 (W9500-160X20)

### MECHANICAL PROPERTIES<sup>(1)</sup>

Rockwell Hardness (R <sub>c</sub> )	Wear Resistance
58-62	ASTM G65-04 Procedure A 0.22 g mass loss

### DEPOSIT COMPOSITION<sup>(1)</sup>

%Fe	%C	%Cr	%B	%Nb	%Mn	%Si
Balance	<3	<10	<6	<9	<5	<2

### TYPICAL OPERATING PROCEDURES

Diameter, Polarity ESO - in (mm)	Current (Amps)	Voltage (Volts)	Wire Feed Speed m/min (ipm)	Shielding Gas	Flow Rate (cfh)
<b>1/16 in (1.6mm), DC+</b> ½ - ¾ (15) GMAW-C ¾ - 1 (20) FCAW-S	200-350	23-28 for Globular Transfer 27-33 for Spray Transfer - 98Ar/2O <sub>2</sub> recommended	7.0 (275)	98%Ar/2%O <sub>2</sub> or Ar/CO <sub>2</sub> blends	40-60

<sup>(1)</sup>Two layers

#### ADDITIONAL NOTES:

Torch Oscillation Rate: 40-70 OSC/min.

Torch Oscillation Width: 5/8 - 1 in. (16-25 mm)

Beam Tilt for Elevation Band (for 18° Groove): 17° +/-1°

Bead Overlap: 1/8-1/4 in. (3-6 mm)

Max. Interpass Temp: 850°F (454 °C)

Soak Heat: 50°F (10 °C) max. temp. change in 4 min.

Recommended Wire Storage: On pallet in dry area.

#### IMPORTANT: SPECIAL VENTILATION AND/OR EXHAUST REQUIRED

Fumes from the normal use of some welding products can contain significant quantities of components - such as chromium and manganese - which can lower the 5.0 mg/m<sup>3</sup> maximum exposure guideline for general welding fume.

BEFORE USE, READ AND UNDERSTAND THE SAFETY DATA SHEET (SDS) FOR THIS PRODUCT AND SPECIFIC INFORMATION PRINTED ON THE PRODUCT CONTAINER.

# WEARTECH® SHS® 7570W

Severe Abrasion

## KEY FEATURES

- Excellent corrosion resistance and high wear and impact resistance
- Especially resistant to corrosion in high chloride and seawater
- Alternative to nickel and superalloys and stainless steels

## TYPICAL APPLICATIONS

- Oil & Gas
- Power Generation
- Pulp & Paper

## DIAMETERS / PACKAGING

Diameter in (mm)	25 lb (11.3 kg) Spool PLW
1/16 (1.6)	W7570-160X11 (ED035664*)

\* EDO numbers have been discontinued and replaced by the Weartech part numbers for the cross selling program.

## MECHANICAL PROPERTIES

Vickers Hardness (HV0.3)	Wear Resistance	Bond Strength ksi (MPa)
950-1150	ASTM G65-04 Procedure B 0.20 g mass loss	ASTM C633-01 Glue Failure 8 (55)

## DEPOSIT COMPOSITION

%Fe	%C	%Cr	%B	%Mo	%W	%Mn	%Si
Balance	<2	<25	<5	<15	<5	<2	<2

## TYPICAL OPERATING PROCEDURES

Tip Size in (mm)	Air Cap	Positioner	Amperes (Amps)	Voltage (V)	Air Motor (psi)	Atomizing Air (psi)	Arc Jet Air (psi)	Transverse Rate in/min (m/min)	Standoff in (mm)
1/16 (1.6)	Blue	Short Cross	200	32	50	70	80	276 (7)	6 (152)

\* This procedure was developed on a TAFE 8830/8835 system. Changes in equipment, materials, and substrates may change optimum procedures. Listed procedures should only be used as a starting point.

IMPORTANT: SPECIAL VENTILATION AND/OR EXHAUST REQUIRED

Fumes from the normal use of some welding products can contain significant quantities of components - such as chromium and manganese - which can lower the 5.0 mg/m<sup>3</sup> maximum exposure guideline for general welding fume.

BEFORE USE, READ AND UNDERSTAND THE SAFETY DATA SHEET (SDS) FOR THIS PRODUCT AND SPECIFIC INFORMATION PRINTED ON THE PRODUCT CONTAINER.



# WEARTECH® SHS® 8000W

Severe Abrasion

## KEY FEATURES

- Excels in elevated temperature environments where fly ash and bed ash erosion occurs
- Superior bond strength without necessity of bond coat
- Hardness increases as a function of time and temperature

## TYPICAL APPLICATIONS

- Boiler Tubes
- Oil & Gas
- Power Generation
- Pulp & Paper

## DIAMETERS / PACKAGING

Diameter in (mm)	25 lb (11.3 kg) Spool PLW	400 lb (181 kg) Accu-Trak Drum
1/16 (1.6)	W8000-160X11 (ED035665*)	W8000-160BULK (ED035972*)

\* EDO numbers have been discontinued and replaced by the Weartech part numbers for the cross selling program.

## MECHANICAL PROPERTIES

Vickers Hardness (HV0.3)	Wear Resistance	Bond Strength ksi (MPa)
1000-1200	ASTM G65-04 Procedure B 0.18 g mass loss	ASTM C633-01 Glue Failure 8 (55)

## DEPOSIT COMPOSITION

%Fe	%C	%Cr	%B	%Mo	%Nb	%Mn	%Si
Balance	<2	<22	<5	<5	<5	<1	<1

## TYPICAL OPERATING PROCEDURES

Tip Size in (mm)	Air Cap	Positioner	Amperes (Amps)	Voltage (V)	Air Motor (psi)	Atomizing Air (psi)	Arc Jet Air (psi)	Transverse Rate in/min (m/min)	Standoff in (mm)
1/16 (1.6)	Blue	Short Cross	250	32	50	70	80	276 (7)	6 (152)

\* This procedure was developed on a TAFE 8830/8835 system. Changes in equipment, materials, and substrates may change optimum procedures. Listed procedures should only be used as a starting point.

<p>IMPORTANT: SPECIAL VENTILATION AND/OR EXHAUST REQUIRED</p> <p>Fumes from the normal use of some welding products can contain significant quantities of components - such as chromium and manganese - which can lower the 5.0 mg/m<sup>3</sup> maximum exposure guideline for general welding fume.</p> <p>BEFORE USE, READ AND UNDERSTAND THE SAFETY DATA SHEET (SDS) FOR THIS PRODUCT AND SPECIFIC INFORMATION PRINTED ON THE PRODUCT CONTAINER.</p>
--

# WEARTECH® SHS® 9172W

Severe Abrasion

## KEY FEATURES

- Excels in extreme environments where severe abrasion is encountered
- Significant ability to withstand corrosion and high temperature oxidation
- Exceptional wear resistance in applications involving fine particle abrasion and erosion

## TYPICAL APPLICATIONS

- LPA Screens
- Oil & Gas
- Power Generation
- Pulp & Paper

## DIAMETERS / PACKAGING

Diameter in (mm)	25 lb (11.3 kg) Spool PLW
1/16 (1.6)	W9172-160X11 (ED035666*)

\* EDO numbers have been discontinued and replaced by the Weartech part numbers for the cross selling program.

## MECHANICAL PROPERTIES

Vicker's Hardness (HV0.3)	Wear Resistance	Bond Strength ksi (MPa)
975 - 1025	ASTM G65-04 Procedure B 0.17 g mass loss	ASTM C633-01 Glue Failure 6 (41)

## DEPOSIT COMPOSITION

%Fe	%C	%Cr	%B	%Mo	%Nb	%W	%Mn	%Si
Balance	<4	<25	<5	<6	<12	<15	<3	<2

## TYPICAL OPERATING PROCEDURES

Tip Size in (mm)	Air Cap	Positioner	Amperes (Amps)	Voltage (V)	Air Motor (psi)	Atomizing Air (psi)	Arc Jet Air (psi)	Transverse Rate in/min (m/min)	Standoff in (mm)
1/16 (1.6)	Blue	Short Cross	200	32	50	70	80	276 (7)	6 (152)

\* This procedure was developed on a TAFE 8830/8835 system. Changes in equipment, materials, and substrates may change optimum procedures. Listed procedures should only be used as a starting point.

IMPORTANT: SPECIAL VENTILATION AND/OR EXHAUST REQUIRED

Fumes from the normal use of some welding products can contain significant quantities of components - such as chromium and manganese - which can lower the 5.0 mg/m<sup>3</sup> maximum exposure guideline for general welding fume.

BEFORE USE, READ AND UNDERSTAND THE SAFETY DATA SHEET (SDS) FOR THIS PRODUCT AND SPECIFIC INFORMATION PRINTED ON THE PRODUCT CONTAINER.

# WEARTECH® SHS® 7574HV

Severe Abrasion

## KEY FEATURES

- Outstanding corrosion resistance in high chlorine, salt fog, concentrated salt and seawater environments
- Can be finished to very high surface specifications for use as a replacement for hard chrome
- High bond strength, low porosity and high impact resistance
- Corrosion resistance is superior to crystalline austenitic stainless steel and nickel based superalloys

## TYPICAL APPLICATIONS

- Oil & Gas
- Power Generation
- Mining
- Pulp & Paper
- Offshore & Marine

## DIAMETERS / PACKAGING

Size Micron (µm)	10 lb (4.5 kg) Bottle
+15/-53	P7574-15/53 (ED035730*)

\* EDO numbers have been discontinued and replaced by the Wearthech part numbers for the cross selling program.

## MECHANICAL PROPERTIES

Vicker's Hardness (HV0.3)	Wear Resistance	Bond Strength ksi (MPa)
975 - 1075	ASTM G65-04 Procedure B 0.13 g mass loss	ASTM C633-01 Glue Failure 10 (69)

## DEPOSIT COMPOSITION

%Fe	%C	%Cr	%B	%Mo	%Mn	%Si	%W
Balance	<3	<25	<5	<20	<5	<2	<10

## TYPICAL OPERATING PROCEDURES

Feeder Speed (rpm)	Gas Flow (cfh)	Powder Feed Rate lb/hr (g/min)	Spray Distance in (mm)	Deposit Rate (mil/pass)
270 (6 pitch screw)	21	5 (37.8)	14 (356)	0.5-0.7
Fuel Flow Rate gal/hr (l/min)	Fuel Pressure (psi)	Oxygen Flow Rate (cfh)	Oxygen Pressure (psi)	Combustion (psi)
6 (0.45)	120	2100	135	100

\* This procedure was developed on a TAFE JP5000. Changes in equipment, materials, and substrates may change optimum procedures. Listed procedures should only be used as a starting point.

<p><b>IMPORTANT: SPECIAL VENTILATION AND/OR EXHAUST REQUIRED</b></p> <p>Fumes from the normal use of some welding products can contain significant quantities of components - such as chromium and manganese - which can lower the 5.0 mg/m<sup>3</sup> maximum exposure guideline for general welding fume.</p> <p>BEFORE USE, READ AND UNDERSTAND THE SAFETY DATA SHEET (SDS) FOR THIS PRODUCT AND SPECIFIC INFORMATION PRINTED ON THE PRODUCT CONTAINER.</p>
---

# WEARTECH® SHS® 8000HV

## Severe Abrasion

### KEY FEATURES

- Excels in high abrasion, erosion environments, both wet and dry
- Very good metal to metal (two body) wear resistance
- Superior bond strength without necessity of bond coat
- Can be finished to very high surface specifications

### TYPICAL APPLICATIONS

- Oil & Gas
- Power Generation
- Mining
- Pulp & Paper

### DIAMETERS / PACKAGING

Size Micron (µm)	10 lb (4.5 kg) Bottle
+15/-53	P8000-15/53 (ED035732*)

\* EDO numbers have been discontinued and replaced by the Wearthech part numbers for the cross selling program.

### MECHANICAL PROPERTIES

Vicker's Hardness (HV0.3)	Wear Resistance	Bond Strength ksi (MPa)
1000	ASTM G65-04 Procedure B 0.07 g mass loss	ASTM C633-01 Glue Failure 10 (69)

### DEPOSIT COMPOSITION

%Fe	%C	%Cr	%B	%Mo	%Nb	%Mn	%Si	%W
Balance	<4	<25	<5	<6	<12	<3	<2	<12

### TYPICAL OPERATING PROCEDURES

Feeder Speed (rpm)	Gas Flow (cfh)	Powder Feed Rate lb/hr (g/min)	Spray Distance in (mm)	Deposit Rate (mil/pass)
270 (6 pitch screw)	21	10 (75.6)	14 (356)	0.2-0.4
Fuel Flow Rate gal/hr (l/min)	Fuel Pressure (psi)	Oxygen Flow Rate (cfh)	Oxygen Pressure (psi)	Combustion (psi)
6 (0.45)	120	1900	135	100

\* This procedure was developed on a TAFA JP5000. Changes in equipment, materials, and substrates may change optimum procedures. Listed procedures should only be used as a starting point.

#### IMPORTANT: SPECIAL VENTILATION AND/OR EXHAUST REQUIRED

Fumes from the normal use of some welding products can contain significant quantities of components - such as chromium and manganese - which can lower the 5.0 mg/m<sup>3</sup> maximum exposure guideline for general welding fume.

BEFORE USE, READ AND UNDERSTAND THE SAFETY DATA SHEET (SDS) FOR THIS PRODUCT AND SPECIFIC INFORMATION PRINTED ON THE PRODUCT CONTAINER.

# WEARTECH® SHS® 9172HV

## Severe Abrasion

### KEY FEATURES

- Excels in high sulfur and elevated temperature environments where fly-ash and bed-ash erosion occurs
- Exceptional abrasion resistance for a metallic material
- Significant corrosion and high temperature oxidation resistance
- Very high bond strength across a range of substrate materials, including aluminum, copper, carbon steel and stainless steel.
- Can be finished to very high surface specifications as a replacement for hard chrome
- Hardness and corrosion and wear resistance is superior to hard chrome

### TYPICAL APPLICATIONS

- Oil & Gas
- Power Generation
- Mining
- Pulp & Paper

### DIAMETERS / PACKAGING

Size Micron (µm)	10 lb (4.5 kg) Bottle
+15/-53	P9172-15/53 (ED035734*)

\* EDO numbers have been discontinued and replaced by the Wearthech part numbers for the cross selling program.

### MECHANICAL PROPERTIES

Vicker's Hardness (HV0.3)	Wear Resistance	Bond Strength ksi (MPa)
1000 - 1100	ASTM G65-04 Procedure B 0.07 g mass loss	ASTM C633-01 Glue Failure 10 (69)

### DEPOSIT COMPOSITION

%Fe	%C	%Cr	%B	%Mo	%Nb	%W	%Mn	%Si
Balance	<4	<25	<5	<6	<12	<15	<3	<2

### TYPICAL OPERATING PROCEDURES

Feeder Speed (rpm)	Gas Flow (cfh)	Powder Feed Rate lb/hr (g/min)	Spray Distance in (mm)	Deposit Rate (mil/pass)
270 (6 pitch screw)	21	10 (75.6)	14 (356)	0.2-0.4
Fuel Flow Rate gal/hr (l/min)	Fuel Pressure (psi)	Oxygen Flow Rate (cfh)	Oxygen Pressure (psi)	Combustion (psi)
6 (0.45)	120	1900	135	100

\* This procedure was developed on a TAFA JP5000. Changes in equipment, materials, and substrates may change optimum procedures. Listed procedures should only be used as a starting point.

#### IMPORTANT: SPECIAL VENTILATION AND/OR EXHAUST REQUIRED

Fumes from the normal use of some welding products can contain significant quantities of components - such as chromium and manganese - which can lower the 5.0 mg/m<sup>3</sup> maximum exposure guideline for general welding fume.

BEFORE USE, READ AND UNDERSTAND THE SAFETY DATA SHEET (SDS) FOR THIS PRODUCT AND SPECIFIC INFORMATION PRINTED ON THE PRODUCT CONTAINER.

# WEARTECH® SHS® 9290P

Severe Abrasion

## KEY FEATURES

- Alternative to 65% tungsten carbide PAW materials
- Provides exceptional uniformity of hardness and wear performance across a range of service environments

## TYPICAL APPLICATIONS

- Crusher Rolls
- Ore Chutes
- Screw Augers

## DIAMETERS / PACKAGING

Size Micron (µm)	10 lb (4.5 kg) Bottle
+53/-180	P9290-53/180 (ED035722*)

\* EDO numbers have been discontinued and replaced by the Wearthech part numbers for the cross selling program.

## MECHANICAL PROPERTIES<sup>(1)</sup>

Rockwell Hardness (R <sub>c</sub> )	Wear Resistance
71-74	ASTM G65-04 Procedure A 0.08 g mass loss

## DEPOSIT COMPOSITION<sup>(1)</sup>

%Fe	%C	%Cr	%B	%Mo	%Nb	%W	%Mn	%Si	%V
Balance	<5	<20	<10	<10	<10	<15	<5	<2	<5

## TYPICAL OPERATING PROCEDURES

Current (Amps)	Voltage (Volts)	Powder Feed Rate lb/hr (g/min)	Shielding Gas	Flow Rate (cfh)	Plasma Gas
190	23	6 (45)	100% Ar	25	100% Ar
Oscillation in (mm)	Oscillation Rate (hz)	Dwell Time (s)	Slew Time (s)	Travel Speed in/min (mm/min)	
0.75 (19)	1	0.05	0.5	3.5 (89)	

<sup>(1)</sup> Composition and properties depend upon dilution. Single layer deposit properties depend upon base metal and/or build-up material.

\* This procedure was developed on a Eutectic GAP 375 power source and a Eutectic GAP E52 torch. Changes in equipment, materials, and substrates may change optimum procedures. Listed procedures should only be used as a starting point.

<p>IMPORTANT: SPECIAL VENTILATION AND/OR EXHAUST REQUIRED</p> <p>Fumes from the normal use of some welding products can contain significant quantities of components - such as chromium and manganese - which can lower the 5.0 mg/m<sup>3</sup> maximum exposure guideline for general welding fume.</p> <p>BEFORE USE, READ AND UNDERSTAND THE SAFETY DATA SHEET (SDS) FOR THIS PRODUCT AND SPECIFIC INFORMATION PRINTED ON THE PRODUCT CONTAINER.</p>
--

# WEARTECH® SHS® 9700P

Severe Abrasion

## KEY FEATURES

- Economical iron-based alternative to nickel based materials containing tungsten carbide
- Good resistance to abrasion and erosion from fine particles
- Highly refined microstructure

## TYPICAL APPLICATIONS

- Wearplate
- Crusher Rolls
- Ore Chutes
- Screw Augers

## DIAMETERS / PACKAGING

Size Micron (µm)	10 lb (4.5 kg) Bottle
+53/-180	P9700-53/180 (ED035724*)

\* EDO numbers have been discontinued and replaced by the Wearthech part numbers for the cross selling program.

## MECHANICAL PROPERTIES<sup>(1)</sup>

Rockwell Hardness (R <sub>c</sub> )	Wear Resistance
67-69	ASTM G65-04 Procedure A 0.13 g mass loss

## DEPOSIT COMPOSITION<sup>(1)</sup>

%Fe	%C	%Cr	%B	%Nb	%Mn	%Si
Balance	<2	<21	<7	<6	<2	<2

## TYPICAL OPERATING PROCEDURES

Current (Amps)	Voltage (Volts)	Powder Feed Rate lb/hr (g/min)	Shielding Gas	Flow Rate (cfh)	Plasma Gas
180	22	3.3-3.9 (25-29)	95 Ar – 5 H <sub>2</sub>	25	100% Ar
Oscillation in (mm)	Oscillation Rate (hz)	Dwell Time (s)	Slew Time (s)	Travel Speed in/min (mm/min)	
0.6 (15)	1	0.1	0.4	3.5 (89)	

\* This procedure was developed on a Eutectic GAP 375 power source and a Eutectic GAP E52 torch. Changes in equipment, materials, and substrates may change optimum procedures. Listed procedures should only be used as a starting point.

<p>IMPORTANT: SPECIAL VENTILATION AND/OR EXHAUST REQUIRED</p> <p>Fumes from the normal use of some welding products can contain significant quantities of components - such as chromium and manganese - which can lower the 5.0 mg/m<sup>3</sup> maximum exposure guideline for general welding fume.</p> <p>BEFORE USE, READ AND UNDERSTAND THE SAFETY DATA SHEET (SDS) FOR THIS PRODUCT AND SPECIFIC INFORMATION PRINTED ON THE PRODUCT CONTAINER.</p>
--

# ALUMINUM & CAST IRON

## *Aluminum*

### **MIG Wire**

SuperGlaze® 4043 .....	I-1
SuperGlaze® 4047 .....	I-2
SuperGlaze® 5183 .....	I-3
SuperGlaze® HD 5183.....	I-4
SuperGlaze® 5356 .....	I-5
SuperGlaze® HD 5356.....	I-6
SuperGlaze® 5356 TM™ .....	I-7
SuperGlaze® HD 5356 TM™ .....	I-8
SuperGlaze® 5554 .....	I-9
SuperGlaze® 5556 .....	I-10
SuperGlaze® HD 5556.....	I-11

### **TIG Cut Length**

SuperGlaze® 4043 .....	I-12
SuperGlaze® 5356 .....	I-13

## *Cast Iron*

### **Stick Electrode**

Ferroweld® .....	I-13
------------------	------

## *Additional Information*

Typical Joint Designs.....	I-14
Typical Operating Procedures.....	I-15



# SUPERGLAZE® 4043

Aluminum ■ AWS ER4043

## KEY FEATURES

- Designed for welding heat-treatable base alloys and more specifically 6XXX series alloys
- Lower melting point and more fluidity than 5XXX series filler alloys
- Low sensitivity to weld cracking with 6XXX series base alloys
- Suitable for sustained elevated temperature service, i.e. above 65°C (150°F)
- Not recommended for materials to be anodized

## WELDING POSITIONS

All, except vertical down

## NOTE

- Typical Joint Designs and Operating Procedures on pg. I-14 - I-16

## CONFORMANCES

<b>AWS A5.10:</b>	ER4043
<b>ASME SFA 5.10:</b>	ER4043
<b>CWB/CSA W48-06:</b>	ER4043
<b>ISO 18273:</b>	AlSi5
<b>TUV:</b>	S Al 5356 (AlMg5Cr(A))
<b>DB:</b>	S Al 5356 (AlMg5Cr(A))

## TYPICAL APPLICATIONS

- For welding 6XXX alloys, and most casting alloys
- Automotive components such as frame and drive shafts
- Bicycle frames

## SHIELDING GAS

100% Argon  
Argon / Helium Mixtures  
Flow Rate: 30 - 50 CFH

## DIAMETERS / PACKAGING

Diameter in (mm)	1 lb (0.5 kg) Plastic Spool 20 lb (9.1 kg) Master Carton	16 lb (7.3 kg) Plastic Spool	20 lb (9.1 kg) Plastic Spool	60 lb (27.2 kg) Mini-Drum	300 lb (136 kg) Gem-Pak™ Box
0.030 (0.8)	ED030307				
0.035 (0.9)	ED030308	ED028395		ED036718 <sup>(a)</sup>	ED036609
3/64 (1.2)	ED030310		ED029234	ED036592	ED036610
1/16 (1.6)			ED030281	ED036719	ED036611

<sup>(a)</sup>This part number contains glass gems.

## WIRE COMPOSITION<sup>(1)</sup> – As Required per SFA/AWS A5.10

	%Al	%Si	%Fe	%Cu	%Mn
<b>Requirements</b> - AWS ER4043	Remainder	4.50–6.00	0.80 max	0.30 max	0.05 max
<b>Typical Results</b> <sup>(2)</sup>	Remainder	5.26	0.15	0.01	0.01
	%Mg	%Cr	%Zn	%Ti	%Be
<b>Requirements</b> - AWS ER4043	0.05 max	—	0.10 max	0.20 max	0.0003 max
<b>Typical Results</b> <sup>(2)</sup>	0.03	—	0.001	0.01	<0.0002

<sup>(1)</sup>Typical all weld metal. <sup>(2)</sup>See test results disclaimer

# SUPERGLAZE® 4047

Aluminum ▪ AWS ER4047

## KEY FEATURES

- Lower melting point and higher fluidity than 4043 wires
- Can be used as a substitute for 4043 wires to increase silicon in the weld metal, minimize hot cracking and produce higher fillet weld shear strength

## WELDING POSITIONS

All, except vertical down

## NOTE

- Typical Joint Designs and Operating Procedures on pg. I-14 - I-16

## CONFORMANCES

<b>AWS A5.10:</b>	ER4047
<b>ASME SFA 5.10:</b>	ER4047
<b>EN ISO 18273:</b>	AlSi5

## TYPICAL APPLICATIONS

- Automotive components
- Heat exchangers
- Body panels
- Brazing of aluminum sheets, extrusions and castings

## SHIELDING GAS

100% Argon  
Argon / Helium Mixtures  
Flow Rate: 30 - 50 CFH

## DIAMETERS / PACKAGING

Diameter in (mm)	16 lb (7.3 kg) Plastic Spool	300 lb (136 kg) Gem-Pak™ Box
0.035 (0.9)	EDS28415	
3/64 (1.2)	EDS28417	ED036613
1/16 (1.6)	EDS28418	ED036612

## WIRE COMPOSITION<sup>(1)</sup> – As Required per SFA/AWS A5.10

	%Al	%Si	%Fe	%Cu	%Mn
<b>Requirements</b> - AWS ER4047	Remainder	11.00-13.00	0.80 max	0.30 max	0.15 max
<b>Typical Results</b> <sup>(2)</sup>	As Reported per AWS Requirements				
	%Mg	%Cr	%Zn	%Ti	%Be
<b>Requirements</b> - AWS ER4047	0.10 max	—	0.20 max	—	0.0003 max
<b>Typical Results</b> <sup>(2)</sup>	As Reported per AWS Requirements				

<sup>(1)</sup>Typical all weld metal. <sup>(2)</sup>See test results disclaimer

# SUPERGLAZE® 5183

Aluminum ■ AWS ER5183

## KEY FEATURES

- Designed for applications where higher strength is required
- For 5083 and 5456 base materials

## WELDING POSITIONS

All, except vertical down

## SHIELDING GAS

100% Argon  
Argon / Helium Mixtures  
Flow Rate: 30 - 50 CFH

## NOTE

- Typical Joint Designs and Operating Procedures on pg. I-14 - I-16

## CONFORMANCES

<b>AWS A5.10:</b>	ER5183
<b>ASME SFA 5.10:</b>	ER5183
<b>ABS/AWS:</b>	ER5183 Ar&Ar/He
<b>LR:</b>	WC/I-1 S & I-5 S
<b>DNV-GL:</b>	5183 I-1
<b>BV Grade:</b>	WC
<b>CWB/CSA W48-06:</b>	ER5183
<b>KR:</b>	WC G I-1 & I-5
<b>CCS:</b>	WC I-1
<b>ISO 18273:</b>	AlMg4, 5Mn0, 7(A)
<b>TUV and DB:</b>	AlMg 4, 5 Mn

## TYPICAL APPLICATIONS

- Marine fabrication and repair
- Cryogenic tanks
- Shipbuilding and other high strength structural aluminum applications
- Bicycle frames
- Railing industry
- Offshore industry

## DIAMETERS / PACKAGING

Diameter in (mm)	1 lb (0.5 kg) Plastic Spool 20 lb (9.1 kg) Master Carton	16 lb (7.3 kg) Plastic Spool	300 lb (136 kg) Gem-Pak™ Box
0.035 (0.9)	EDS30322	EDS28437	ED034789
3/64 (1.2)			ED034791
1/16 (1.6)		EDS28438	ED034792

## WIRE COMPOSITION<sup>(1)</sup> – As Required per SFA/AWSA5.10

	%Al	%Si	%Fe	%Cu	%Mn
<b>Requirements</b> - AWS ER5183	Remainder	0.40 max	0.40 max	0.10 max	0.50 - 1.00
<b>Typical Results</b> <sup>(2)</sup>	Remainder	0.03	0.13	0.001	0.65
	%Mg	%Cr	%Zn	%Ti	%Be
<b>Requirements</b> - AWS ER5183	4.30 - 5.20	0.05 - 0.25	0.25 max	0.15 max	0.0003 max
<b>Typical Results</b> <sup>(2)</sup>	4.99	0.10	0.02	0.07	0.0002

<sup>(1)</sup>Typical all weld metal. <sup>(2)</sup>See test results disclaimer

# SUPERGLAZE® HD 5183

Aluminum ■ AWS ER5183

## KEY FEATURES

- Designed for heavy duty applications
- Reduced shavings and improved feedability
- For 5083 and 5456 base materials

## WELDING POSITIONS

All

## SHIELDING GAS

100% Argon  
Argon / Helium Mixtures  
Flow Rate: 30 - 50 CFH for Argon

## NOTE

- Typical Joint Designs and Operating Procedures on pg. I-14 - I-16

## CONFORMANCES

**AWS A5.10:** ER5183  
**Lloyd's Register:** WC/I-1  
**ISO 18273:** AIMg4.5Mn0.7(A)

## TYPICAL APPLICATIONS

- Ideal for aggressive work environments and applications with long conduit lengths
- Marine fabrication and repair
- Cryogenic tanks
- Shipbuilding and other high strength structural aluminum applications
- Railcars
- Offshore industry

## DIAMETERS / PACKAGING

Diameter in (mm)	16 lb (7.3 kg) Steel Spool	20 lb (9.1 kg) Plastic Spool	300 lb (136 kg) Gem-Pak™ Box
0.035 (0.9)	ED035690	ED035691	ED036341
3/64 (1.2)	ED035692	ED035693	ED036342
1/16 (1.6)	ED035694	ED035695	ED036343

## WIRE COMPOSITION<sup>(1)</sup> – As Required per AWS A5.10

	%Al	%Si	%Fe	%Cu	%Mn
<b>Requirements</b> - AWS ER5183	Remainder	0.40 max	0.40 max	0.10 max	0.50-1.0
<b>Typical Results</b> <sup>(2)</sup>	Remainder	0.03	0.13	0.001	0.65
	%Mg	%Cr	%Zn	%Ti	%Be
<b>Requirements</b> - AWS ER5183	4.3-5.2	0.05-0.25	0.25 max	0.15 max	0.0003 max
<b>Typical Results</b> <sup>(2)</sup>	5.0	0.10	0.02	0.07	0.00002

<sup>(1)</sup>Typical wire chemistry. <sup>(2)</sup>See test results disclaimer

# SUPERGLAZE® 5356

Aluminum ▪ AWS ER5356

## KEY FEATURES

- General purpose filler alloy for welding 5XXX series alloys
- The most widely used welding alloy

## WELDING POSITIONS

All, except vertical down

## SHIELDING GAS

100% Argon  
Argon / Helium Mixtures  
Flow Rate: 30 - 50 CFH

## NOTE

- Typical Joint Designs and Operating Procedures on pg. I-14 - I-16

## CONFORMANCES

AWS A5.10:	ER5356
ABS/AWS:	ER5356
ASME SFA A5.10:	ER5356
Lloyd's Register:	WB/I-1 S
DNV-GL:	5356 I-1
BV Grade:	WB
CWB/CSA W48-06:	ER5356
KR:	WB G I-1
TUV and DB:	Al 5356 (AlMg5Cr(A))
ISO 18273:	AlMg5Cr(A)

## TYPICAL APPLICATIONS

- Automotive bumpers and supports
- Structural frames in the shipbuilding industry
- Formed truck panels
- Railing Industry
- Power Industry
- Trailer Manufacturing

## DIAMETERS / PACKAGING

Diameter in (mm)	1 lb (0.4 kg) Plastic Spool 20 lb (9.1 kg) Master Carton	16 lb (7.3 kg) Platic Spool	20 lb (9.1 kg) Plastic Spool	60 lb (27.2 kg) Mini-Drum	300 lb (136 kg) Accu-Pak® Box	300 lb (136 kg) Gem-Pak® Box
0.035 (0.9)	ED030312	ED028385		ED036720 <sup>(c)</sup>	ED033178 <sup>(a)</sup>	ED034722
3/64 (1.2)	ED030314		ED030282	ED036593	ED031826 <sup>(b)</sup>	ED034550
1/16 (1.6)			ED030283	ED036721	ED030985 <sup>(b)</sup>	ED034551

<sup>(a)</sup>This part number is Made-To-Order. <sup>(b)</sup>Wire payoff kit K2860-1 sold separately. <sup>(c)</sup>This part number contains glass gems.

## WIRE COMPOSITION<sup>(1)</sup> – As Required per SFA/AWS A5.10

	%Al	%Si	%Fe	%Cu	%Mn
<b>Requirements</b> - AWS ER5356	Remainder	0.25 max	0.40 max	0.10 max	0.05 - 0.20
<b>Typical Results</b> <sup>(2)</sup>	Remainder	0.05	0.09	0.03	0.12
	%Mg	%Cr	%Zn	%Ti	%Be
<b>Requirements</b> - AWS ER5356	4.50 - 5.50	0.05 - 0.20	0.10 max	0.06 - 0.20	0.0003 max
<b>Typical Results</b> <sup>(2)</sup>	4.90	0.08	< 0.01	0.15	0.0002

<sup>(1)</sup>Typical all weld metal. <sup>(2)</sup>See test results disclaimer

# SUPERGLAZE® HD 5356

Aluminum ▪ AWS ER5356

## KEY FEATURES

- Designed for heavy duty applications
- Reduced shavings and improved feedability
- General purpose filler alloy for welding 5XXX series alloys

## WELDING POSITIONS

All

## SHIELDING GAS

100% Argon  
Argon / Helium Mixtures  
Flow Rate: 30 - 50 CFH for Argon

## NOTE

- Typical Joint Designs and Operating Procedures on pg. I-14 - I-16

## CONFORMANCES

AWS A5.10: ER5356  
ISO 1B273: AlMg5Cr(A)

## TYPICAL APPLICATIONS

- Ideal for aggressive work environments and applications with long conduit lengths
- Automotive bumpers and supports
- Structural frames in the shipbuilding industry
- Formed truck panels
- Railcars
- Power industry
- Trailer manufacturing

## DIAMETERS / PACKAGING

Diameter in (mm)	16 lb (7.3 kg) Steel Spool	20 lb (9.1 kg) Plastic Spool	60 lb (27.2 kg) Mini-Drum	300 lb (136 kg) Gem-Pak™ Box
0.035 (0.9)	ED035672	ED035673		ED036335
3/64 (1.2)	ED035674	ED035675	ED036595	ED036336
1/16 (1.6)	ED035676	ED035677		ED036337

## WIRE COMPOSITION<sup>(1)</sup> – As Required per AWS A5.10

	%Al	%Si	%Fe	%Cu	%Mn
<b>Requirements</b> - AWS ER5356	Remainder	0.25 max	0.40 max	0.10 max	0.05-0.20
<b>Typical Results</b> <sup>(2)</sup>	Remainder	0.05	0.09	0.03	0.12
	%Mg	%Cr	%Zn	%Ti	%Be
<b>Requirements</b> - AWS ER5356	4.5-5.5	0.05-0.20	0.10 max	0.06-0.20	0.0003 max
<b>Typical Results</b> <sup>(2)</sup>	4.9	0.08	<0.01	0.15	0.0002

<sup>(1)</sup>Typical wire chemistry. <sup>(2)</sup>See test results disclaimer

# SUPERGLAZE® 5356 TM™

Aluminum ▪ AWS ER5356

## KEY FEATURES

- Unparalleled bead profile and appearance which are critical for groove and fillet welds on aluminum trailer beds.
- SuperGlaze® 5356 TM™ has an engineered chemical composition developed specifically to outperform standard ER5356 electrodes and gives the operator unprecedented control.
- Proprietary manufacturing processes give SuperGlaze® 5356 TM™ the smoothest surface finish in the industry, making it ideal for automatic applications on formed truck panels.

## WELDING POSITIONS

All, except vertical down

## NOTE

- Typical Joint Designs and Operating Procedures on pg. I-14 - I-16

## CONFORMANCES

<b>AWS A5.10:</b>	ER5356
<b>ASME SFA-5.10:</b>	ER5356
<b>CWB/CSA W48-06:</b>	ER5356
<b>ISO 18273:</b>	AlMg5Cr(A)
<b>TUV and DB:</b>	AlMg5Cr(A)

## TYPICAL APPLICATIONS

- High speed groove welds on formed truck panels
- Multi-pass fillet and lap welds on 6XXX series base materials
- Robotic fillet welds on trailer tanks requiring minimal post-weld clean up

## SHIELDING GAS

100% Argon  
Argon / Helium Mixtures  
Flow Rate: 30 - 50 CFH

## DIAMETERS / PACKAGING

Diameter in (mm)	1 lb (0.4 kg) Plastic Spool 20 lb (9.1 kg) Master Carton	16 lb (7.3 kg) Steel Spool	20 lb (9.1 kg) Plastic Spool	60 lb (27.2 kg) Mini-Drum	300 lb (136 kg) Gem-Pak™
0.035 (0.9)	ED034064	ED034067			ED034723
3/64 (1.2)	ED034065	ED034068	ED034070	ED036594	ED034724
1/16 (1.6)	ED034066	ED034069	ED034071		ED034729

## WIRE COMPOSITION<sup>(1)</sup> – As Required per SFA/AWS A5.10

	%Al	%Si	%Fe	%Cu	%Mn
<b>Requirements</b> - AWS ER5356	Remainder	0.25 max	0.40 max	0.10 max	0.05 - 0.20
<b>Typical Results<sup>(2)</sup></b>	Remainder	0.065	0.15	0.0035	0.125
	%Mg	%Cr	%Zn	%Ti	%Be
<b>Requirements</b> - AWS ER5356	4.50 - 5.50	0.05 - 0.20	0.10 max	0.06 - 0.20	0.0003 max
<b>Typical Results<sup>(2)</sup></b>	4.565	0.11	0.0075	0.085	0.0002

<sup>(1)</sup>Typical all weld metal. <sup>(2)</sup>See test results disclaimer

# SUPERGLAZE® HD 5356 TM™

Aluminum ▪ AWS ER5356

## KEY FEATURES

- Designed for heavy duty applications
- Reduced shavings and improved feedability
- High speed groove welds on formed truck panels
- Multi-pass fillet and lap welds on 6XXX series base materials
- Robotic fillet welds on trailer tanks requiring minimal post-weld clean up

## WELDING POSITIONS

All

## NOTE

- Typical Joint Designs and Operating Procedures on pg. I-14 - I-16

## CONFORMANCES

<b>AWS A5.10:</b>	ER5356
<b>ASME SFA-5.10:</b>	ER5356
<b>CWB/CSA W48-06:</b>	ER5356
<b>ISO 18273:</b>	AlMg5Cr(A)
<b>TUV and DB:</b>	AlMg5Cr(A)

## TYPICAL APPLICATIONS

- Ideal for aggressive work environments and applications with long conduit lengths
- Trailer manufacturing

## SHIELDING GAS

100% Argon  
 Argon / Helium Mixtures  
 Flow Rate: 30 - 50 CFH for Argon

## DIAMETERS / PACKAGING

Diameter in (mm)	16 lb (7.3 kg) Steel Spool	20 lb (9.1 kg) Plastic Spool	60 lb (27.2 kg) Mini-Drum	300 lb (136 kg) Gem-Pak™ Box
0.035 (0.9)				ED036338
3/64 (1.2)	ED035698	ED035699	ED036596	ED036339
1/16 (1.6)	ED035700	ED035701		ED036340

## WIRE COMPOSITION<sup>(1)</sup> – As Required per AWS A5.10

	%Al	%Si	%Fe	%Cu	%Mn
<b>Requirements - AWS ER5356</b>	Remainder	0.25 max	0.40 max	0.10 max	0.05-0.20
	%Mg	%Cr	%Zn	%Ti	%Be
<b>Requirements - AWS ER5356</b>	4.5-5.5	0.05-0.20	0.10 max	0.06-0.20	0.0003 max

<sup>(1)</sup>Typical wire chemistry.



# SUPERGLAZE® 5554

Aluminum ▪ AWS ER5554

## KEY FEATURES

- Matching filler alloy for welding 5454 base alloys
- Low magnesium content to closely match the base material chemistry
- Suitable for sustained elevated temperature service, i.e. above 65°C (150°F)

## WELDING POSITIONS

All, except vertical down

## NOTE

- Typical Joint Designs and Operating Procedures on pg. I-14 - I-16

## CONFORMANCES

<b>AWS A5.10:</b>	ER5554
<b>ASME SFA 5.10:</b>	ER5554
<b>CWB/CSA W48-06:</b>	ER5554

## TYPICAL APPLICATIONS

- 5454 base alloys
- Automotive wheels
- Transportation applications such as over-the-road trailers and rail tank cars
- Chemical storage tanks

## SHIELDING GAS

100% Argon  
Argon / Helium Mixtures  
Flow Rate: 30 - 50 CFH

## DIAMETERS / PACKAGING

Diameter in (mm)	16 lb (7.3 kg) Plastic Spool	300 lb (136 kg) Gem-Pak® Box
3/64 (1.2)	ED029573	ED034725
1/16 (1.6)		ED034730

## WIRE COMPOSITION<sup>(1)</sup> – As Required per SFA/AWS A5.10

	%Al	%Si	%Fe	%Cu	%Mn
<b>Requirements</b> - AWS ER5554	Remainder	0.25 max	0.40 max	0.10 max	0.50 - 1.00
<b>Typical Results</b> <sup>(2)</sup>	Remainder	0.06	0.13	0.03	0.51
	%Mg	%Cr	%Zn	%Ti	%Be
<b>Requirements</b> - AWS ER5554	2.40 - 3.00	0.05 - 0.20	0.25 max	0.05 - 0.20	0.0003 max
<b>Typical Results</b> <sup>(2)</sup>	2.41	0.06	< 0.01	0.09	0.0001

<sup>(1)</sup>Typical all weld metal. <sup>(2)</sup>See test results disclaimer

# SUPERGLAZE® 5556

Aluminum ▪ AWS ER5556

## KEY FEATURES

- Provide higher tensile strengths for welding of higher strength 5XXX alloys, such as 5456
- Increased amounts of magnesium and manganese

## WELDING POSITIONS

All, except vertical down

## NOTE

- Typical Joint Designs and Operating Procedures on pg. I-14 - I-16

## CONFORMANCES

<b>AWS A5.10:</b>	ER5556
<b>ASME SFA A5.10:</b>	ER5556
<b>ABS/AWS:</b>	ER5356 Ar
<b>ISO 18273:</b>	AlMg5Mn1Ti(A)

## TYPICAL APPLICATIONS

- 5XXX alloys, such as 5083 and 5456
- Pressure vessels
- Storage tanks
- Military

## SHIELDING GAS

100% Argon  
Argon / Helium Mixtures  
Flow Rate: 30 - 50 CFH

## DIAMETERS / PACKAGING

Diameter in (mm)	1 lb (0.4 kg) Plastic Spool 20 lb (9.1 kg) Master Carton	16 lb (7.3 kg) Plastic Spool	300 lb (136 kg) Gem-Pak™ Box
3/64 (1.2)	EDS30329	EDS29581	ED034767
1/16 (1.6)		EDS29582	ED034731
3/32 (2.4)		ED034175	

## WIRE COMPOSITION<sup>(1)</sup> – As Required per SFA/AWS A5.10

	%Al	%Si	%Fe	%Cu	%Mn
<b>Requirements</b> - AWS ER5556	Remainder	0.25 max	0.40 max	0.10 max	0.50 - 1.00
<b>Typical Results</b> <sup>(2)</sup>	Remainder	0.03	0.13	0.001	0.65
	%Mg	%Cr	%Zn	%Ti	%Be
<b>Requirements</b> - AWS ER5556	4.70 - 5.50	0.05 - 0.20	0.25 max	0.05 - 0.20	0.0003 max
<b>Typical Results</b> <sup>(2)</sup>	5.00	0.10	0.02	0.07	0.0002

<sup>(1)</sup>Typical all weld metal. <sup>(2)</sup>See test results disclaimer

# SUPERGLAZE® HD 5556

Aluminum ▪ AWS ER5556

## KEY FEATURES

- Designed for heavy duty applications
- Reduced shavings and improved feedability
- Provide higher tensile strengths for welding 5XXX series alloys
- Increased amounts of magnesium and manganese

## WELDING POSITIONS

All

## NOTE

- Typical Joint Designs and Operating Procedures on pg. I-14 - I-16

## CONFORMANCES

AWS A5.10: ER5556  
ISO 18273: AlMg5Mn1Ti(A)

## TYPICAL APPLICATIONS

- Ideal for aggressive work environments and applications with long conduit lengths
- Pressure vessels
- Storage tanks

## SHIELDING GAS

100% Argon  
Argon / Helium Mixtures  
Flow Rate: 30 - 50 CFH for Argon

## DIAMETERS / PACKAGING

Diameter in (mm)	16 lb (7.3 kg) Steel Spool	20 lb (9.1 kg) Plastic Spool	300 lb (136 kg) Gem-Pak™ Box
0.035 (0.9)			ED036380
3/64 (1.2)	ED035680	ED035681	ED036381
1/16 (1.6)			ED036382

## WIRE COMPOSITION<sup>(1)</sup> – As Required per AWS A5.10

	%Al	%Si	%Fe	%Cu	%Mn
<b>Requirements</b> - AWS ER5556	Remainder	0.25 max	0.40 max	0.10 max	0.50 - 1.0
<b>Typical Results</b> <sup>(2)</sup>	Remainder	0.03	0.13	0.001	0.65
	%Mg	%Cr	%Zn	%Ti	%Be
<b>Requirements</b> - AWS ER5556	4.7 - 5.5	0.05 - 0.20	0.25 max	0.05 - 0.20	0.0003 max
<b>Typical Results</b> <sup>(2)</sup>	5.0	0.10	0.02	0.07	0.0002

<sup>(1)</sup>Typical wire chemistry. <sup>(2)</sup>See test results disclaimer

# SUPERGLAZE® 4043

Aluminum ▪ AWS ER4043

## KEY FEATURES

- Use on many weldable cast and wrought aluminum alloys
- Generally recommended for welding 5052, any 6XXX series alloys and castings
- Embossed on each end for easy identification after use

## WELDING POSITIONS

All

## NOTE

- Typical Joint Designs and Operating Procedures on pg. I-14 - I-16

## CONFORMANCES

<b>AWS A5.10:</b>	ER4043
<b>ASME SFA-5.10:</b>	ER4043
<b>ISO 18273:</b>	AlSi5
<b>DB and TUV:</b>	AlSi5

## TYPICAL APPLICATIONS

- Bicycle frames
- Pressure vessels

## DIAMETERS / PACKAGING

Diameter in (mm)	10 lb (4.5 kg) Carton
1/16 (1.6)	ED031111
3/32 (2.4)	ED031112
1/8 (3.2)	ED031113

## WIRE COMPOSITION<sup>(1)</sup> – As Required per SFA/AWS A5.10

	%Al	%Si	%Fe	%Cu	%Mn
<b>Requirements</b> - AWS ER4043	Remainder	4.50-6.00	0.80 max	0.30 max	0.05 max
<b>Typical Results</b> <sup>(2)</sup>	Remainder	5.01	0.13	0.008	0.009
	%Mg	%Cr	%Zn	%Ti	%Be
<b>Requirements</b> - AWS ER4043	0.05 max	Not Specified	0.10 max	0.20 max	0.0003 max
<b>Typical Results</b> <sup>(2)</sup>	0.03	—	0.002	0.007	0.0002

<sup>(1)</sup>Typical all weld metal. <sup>(2)</sup>See test results disclaimer

# SUPERGLAZE® 5356

Aluminum ▪ AWS ER5356

## KEY FEATURES

- Aluminum-magnesium alloy for use on many weldable cast and wrought aluminum alloys
- Generally recommended for welding any 5XXX or 6XXX series aluminum alloys
- Excellent for color matching after anodizing
- Embossed on each end for easy identification after use

## WELDING POSITIONS

All

## DIAMETERS / PACKAGING

Diameter in (mm)	10 lb (4.5 kg) Carton
1/16 (1.6)	ED031108
3/32 (2.4)	ED031109
1/8 (3.2)	ED031110

## WIRE COMPOSITION<sup>(1)</sup> – As Required per SFA/AWS A5.10

	%Al	%Si	%Fe	%Cu	%Mn	%Mg	%Cr	%Zn	%Ti	%Be
<b>Requirements - AWS ER5356</b>	Remainder	0.25 max	0.40 max	0.10 max	0.05-0.20	4.05-5.5	0.05-0.20	0.10 max	0.06-0.20	0.0003 max
<b>Typical Results<sup>(2)</sup></b>	Remainder	0.06	0.09	0.02	0.12	4.84	0.12	0.001	0.09	0.0002

<sup>(1)</sup>Typical all weld metal. <sup>(2)</sup>See test results disclaimer

## STICK (SMAW) ELECTRODE

# FERROWELD®

Cast Iron ▪ AWS ESt

## KEY FEATURES

- Deposits may be finished by grinding
- Cost effective option for repairing cast iron

## WELDING POSITIONS

All

## DIAMETERS / PACKAGING

Diameter in (mm)	1 lb (0.5 kg) Plastic Tube 6 lb (2.7 kg) Master Carton	10 lb (4.5 kg) Easy Open Can 30 lb (13.6 kg) Master Carton
1/8 (3.2)	ED031542	ED033882

## TYPICAL OPERATING PROCEDURES

Electrode	Electrode Polarity	Current (Amps)
Ferroweld®	DC+/AC	80 - 120

## CONFORMANCES

<b>AWS A5.10:</b>	ER5356
<b>ASME SFA-5.10:</b>	ER5356
<b>ABS/AWS:</b>	ER5356 Ar
<b>ISO 18273:</b>	AlMg5Cr(A)

## TYPICAL APPLICATIONS

- Architectural structures
- Gun mount bases
- Armored vehicles

## NOTE

- Typical Joint Designs and Operating Procedures on pg. I-14 - I-16

# TYPICAL JOINT DESIGNS

Aluminum MIG Welding

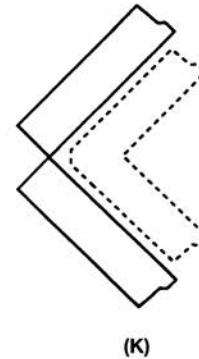
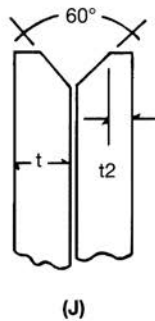
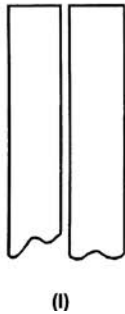
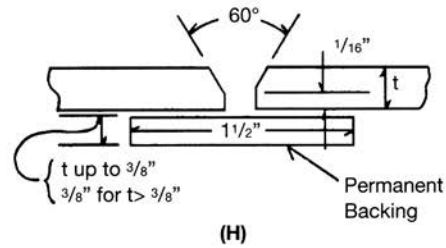
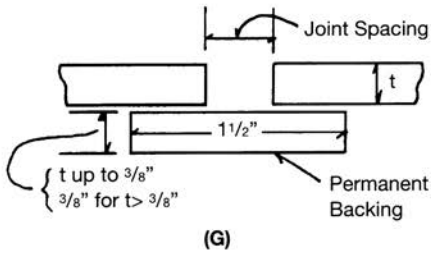
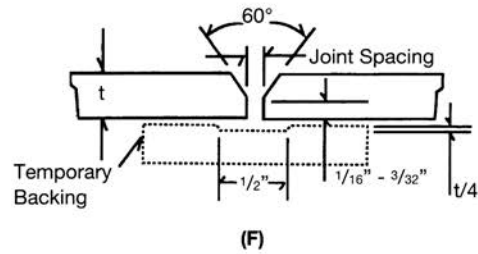
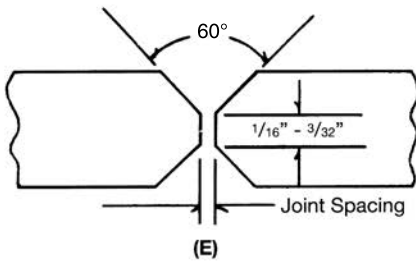
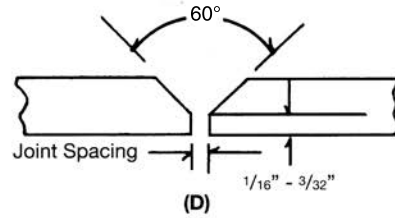
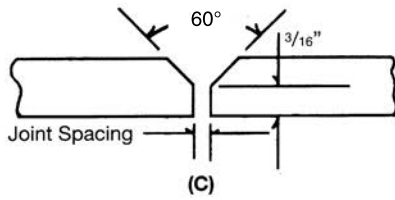
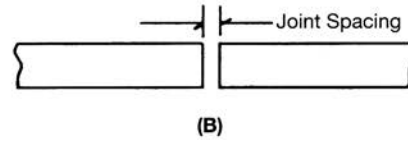
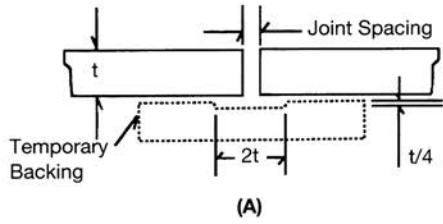

# TYPICAL OPERATING PROCEDURES

## Aluminum MIG Welding

### TYPICAL OPERATING PROCEDURES FOR GROOVE WELDING

Metal Thickness (in)	Weld Position <sup>(1)</sup>	Edge Preparation <sup>(2)</sup>	Joint Spacing (in)	Weld Passes	Electrode Diameter (in)
1/16	F	A	None	1	0.030
	F	G	3/32	1	0.030
1/8	F, V, H	A	0 - 3/32	1	0.030 - 3/64
	F, V, H, O	G	3/16	1	0.030 - 3/64
3/16	F, V, H	B	0 - 1/16	1F, 1R	0.030 - 3/64
	F, V, H	F	0 - 1/16	1	3/64
	O	F	0 - 1/16	2F	3/64
	F, V	H	3/32 - 3/16	2	3/64 - 1/16
	H, O	H	3/16	3	3/64
1/4	F	C-90°	0 - 3/32	1F, 1R	3/64 - 1/16
	F	F	0 - 3/32	2	3/64 - 1/16
	V, H	F	0 - 3/32	3F, 1R	3/64
	O	F	0 - 3/32	3F, 1R	3/64 - 1/16
	F, V	H	1/8 - 1/4	2 - 3	3/64 - 1/16
	O, H	H	1/4	4 - 6	3/64 - 1/16
3/8	F	C-90°	0 - 3/32	1F, 1R	1/16
	F	F	0 - 3/32	2F, 1R	1/16
	V, H	F	0 - 3/32	3F, 1R	1/16
	O	F	0 - 3/32	5F, 1R	1/16
	F, V	H	1/4 - 3/8	4	1/16
	O, H	H	3/8	8 - 10	1/16
3/4	F	C-60°	0 - 3/32	3F, 1R	3/32
	F	F	0 - 1/8	4F, 1R	3/32
	V, H, O	F	0 - 1/16	8F, 1R	1/16
	F	E	0 - 1/16	3F, 3R	1/16
	V, H, O	E	0 - 1/16	6F, 6R	1/16

### TYPICAL OPERATING PROCEDURES FOR GROOVE WELDING

Metal Thickness <sup>(4)</sup> (in)	Weld Position <sup>(1)</sup>	Weld Passes <sup>(5)</sup>	Electrode Diameter (in)	DC+ Current <sup>(3)</sup> (Amps)
1/8	F,	1	0.030 - 3/64	125 - 150
	V, H	1	0.030	110 - 130
	O	1	0.030 - 3/64	115 - 140
3/16	F	1	3/64	180 - 210
	V, H	1	0.030 - 3/64	130 - 175
	O	1	0.030 - 3/64	130 - 190
1/4	F	1	3/64 - 1/16	170 - 240
	V, H	1	3/64	170 - 210
	O	1	3/64 - 1/16	190 - 220
3/8	F	1	1/16	240 - 300
	V, H	3	1/16	190 - 240
	O	3	1/16	200 - 240
3/4	F	4	3/32	360 - 380
	V, H	4-6	1/16	260 - 310
	O	10	1/16	275 - 310

<sup>(1)</sup>F - Flat, V = Vertical, H = Horizontal, O = Overhead. <sup>(2)</sup>See joint designs on page 322. <sup>(3)</sup>For 5XXX series wires, use a welding current on the high side of the range and an arc voltage in the lower portion of the range. For 1XXX and 4XXX series wires, use the lower currents and higher arc voltages. <sup>(4)</sup>Metal thickness of 3/4 in or greater for fillet welds sometimes employs a double vee bevel of 50° or greater included vee with 3/32 in to 1/8 in land thickness on the abutting member. <sup>(5)</sup>Number of weld passes and electrode consumption given for weld on one side only.

# TYPICAL OPERATING PROCEDURES

## Aluminum MIG Welding

DC+ Current <sup>(3)</sup> (Amps)	Arc Voltage <sup>(3)</sup> (Volts)	Argon Gas Flow (cfh)	Arc Travel Speed (ipm/pass)	Approx. Electrode Consump. (lb/100 ft)
70 - 110	15 - 20	25	25 - 45	1.5
70 - 110	15 - 20	25	25 - 45	2
120 - 150	20 - 24	30	24 - 30	2
110 - 135	19 - 23	30	18 - 28	3
130 - 175	22 - 26	35	24 - 30	4
140 - 180	23 - 27	35	24 - 30	5
140 - 175	23 - 27	60	24 - 30	5
140 - 185	23 - 27	35	24 - 30	8
130 - 175	23 - 27	60	25 - 35	10
175 - 200	24 - 28	40	24 - 30	6
185 - 225	24 - 29	40	24 - 30	8
165 - 190	25 - 29	45	25 - 35	10
180 - 200	25 - 29	60	25 - 35	10
175 - 225	25 - 29	40	24 - 30	12
170 - 200	25 - 29	60	25 - 40	12
225 - 290	26 - 29	50	20 - 30	16
210 - 275	26 - 29	50	24 - 35	18
190 - 220	26 - 29	55	24 - 30	20
200 - 250	26 - 29	60	25 - 40	20
210 - 290	26 - 29	50	24 - 30	35
190 - 260	26 - 29	60	25 - 40	50
340 - 400	26 - 31	80	14 - 20	50
325 - 375	26 - 31	80	16 - 20	70
240 - 300	26 - 30	60	24 - 30	75
270 - 330	26 - 30	60	16 - 24	70
230 - 280	26 - 30	80	16 - 24	75

Arc Voltage <sup>(3)</sup> (Volts)	Argon Gas Flow (cfh)	Arc Travel Speed (ipm/pass)	Approx. Electrode Consump. <sup>(5)</sup> (lb/100 ft)
20 - 24	30	24 - 30	2
19 - 23	30	24 - 30	2
20 - 24	40	24 - 30	2
22 - 26	30	24 - 30	4.5
21 - 25	35	24 - 30	4.5
22 - 26	45	24 - 30	4.5
24 - 28	40	24 - 30	7
23 - 27	45	24 - 30	7
24 - 28	60	24 - 30	7
26 - 29	50	18 - 25	17
24 - 27	60	24 - 30	17
25 - 28	60	24 - 30	17
26 - 30	80	18 - 25	66
25 - 20	60	24 - 30	66
25 - 29	60	24 - 30	66





CONSUMABLES  
**PIPELINER**

*Stick (SMAW) Electrode*

**Mild Steel, Cellulosic**

Pipeliners® 6P+ ..... J-1

**Mild Steel, Low Hydrogen**

Pipeliners® 16P ..... J-2

**Low Alloy, Cellulosic**

Pipeliners® 7P+ ..... J-3

Pipeliners® 8P+ ..... J-4

Pipeliners® Arc 80 ..... J-5

**Low Alloy, Low Hydrogen**

Pipeliners® 18P ..... J-6

Pipeliners® LH-D80 ..... J-7

Pipeliners® LH-D90 ..... J-8

Pipeliners® LH-D100 ..... J-9

Pipeliners® 19P ..... J-10

*MIG (GMAW) Wire*

**Mild and Low Alloy Steel Pipe**

Pipeliners® 70S-6 ..... J-11

Pipeliners® 70S-G ..... J-12

Pipeliners® 80S-G ..... J-13

Pipeliners® 80Ni1 ..... J-14

*Flux-Cored Self-Shielded (FCAW-S) Wire*

**Low Alloy, All Position**

Pipeliners® NR®-207+ ..... J-15

Pipeliners® NR®-208-P ..... J-16

Pipeliners® NR®-208-XP ..... J-17

*Flux-Cored Gas-Shielded (FCAW-G) Wire*

**Low Alloy, All Position**

Pipeliners® 81M ..... J-18

Pipeliners® 101M ..... J-19

Pipeliners® 111M ..... J-20

Pipeliners® G90M ..... J-21

*Additional Information*

*Pipe Grades* ..... J-22

*Electrode Selection Guide* ..... J-23

*LH-D80/90/100 Welding Guidelines* ..... J-24

*EN and ISO Classifications* ..... J-25

*Agency Approvals* ..... J-27

# PIPELINER® 6P+

Mild Steel, Cellulosic ▪ AWS E6010

## KEY FEATURES

- Standard in the pipe welding industry for root pass
- High operator appeal and control
- Easy slag removal
- Q2 Lot® - Lot Controlled Chemistry and Mechanical Properties

## TYPICAL APPLICATIONS

- Cross country and in-plant pipe welding
- Root pass on up to X80 grade pipe
- Hot, fill and cap pass on up to X60 grade pipe

## CONFORMANCES

<b>AWS A5:</b>	E6010
<b>ABS:</b>	E6010
<b>CWB/CSA:</b>	E4310
<b>DNV:</b>	3
<b>ISO:</b>	E 42 3 C 2 1

## WELDING POSITIONS

Designed for vertical down welding of cross-country and in-plant pipe

## DIAMETERS / PACKAGING

Diameter mm (in)	Length in (mm)	10 lb (4.5 kg) Easy Open Can 30 lb (13.6 kg) Master Carton	50 lb (22.7 kg) Easy Open Can
2.5 (3/32)	12 (300)	ED032609	
3.2 (1/8)	14 (350)	ED032610	ED030848
4.0 (5/32)	14 (350)	ED032611	ED030849

## MECHANICAL PROPERTIES<sup>(1)</sup> – As Required per AWS A5.1

	Yield Strength <sup>(2)</sup> MPa (ksi)	Tensile Strength MPa (ksi)	Elongation %	Charpy V-Notch J (ft-lbf) @-29°C (-20°F)
<b>Requirements - AWS E6010</b>	330 (48) min	430 (60) min	22 min.	27 (20) min
<b>Typical Results<sup>(3)</sup> - As-Welded</b>	405-515 (59-75)	495-620 (72-90)	22-36	27-85 (20-63)

## DEPOSIT COMPOSITION<sup>(1)</sup> – As Required per AWS A5.1

	%C	%Mn	%Si	%P	%S
<b>Requirements - AWS E6010</b>	0.20 max	1.20 max	1.00 max	Not Specified	Not Specified
<b>Typical Results<sup>(3)</sup> - As-Welded</b>	0.11-0.20	0.51-0.77	0.15-0.32	0.006-0.016	0.005-0.011
	%Ni	%Cr	%Mo	%V	
<b>Requirements - AWS E6010</b>	0.30 max	0.20 max	0.30 max	0.08 max.	
<b>Typical Results<sup>(3)</sup> - As-Welded</b>	0.01-0.04	0.01-0.04	0.01-0.02	≤ 0.01	

## TYPICAL OPERATING PROCEDURES

Polarity <sup>(4)</sup>	Current (Amps)		
	2.5 mm (3/32 in)	3.2 mm (1/8 in)	4.0 mm (5/32 in)
DC+	50-85	75-135	100-175
DC-	50-85	75-135	100-175

<sup>(1)</sup>Typical all weld metal. <sup>(2)</sup>Measured with 0.2% offset. <sup>(3)</sup>See test results disclaimer <sup>(4)</sup>Preferred polarity is listed first.

# PIPELINER® 16P

Mild Steel, Low Hydrogen ■ AWS E7016-1 H4

## KEY FEATURES

- Q2 Lot® - Lot Controlled Chemistry and Mechanical Properties
- DC- (DCEN) is the recommended polarity for root pass welding on pipe

## TYPICAL APPLICATIONS

- Root pass welding of up to X100 grade pipe
- Hot, fill and cap pass welding up to X60
- Low hydrogen, vertical up capability on X60 grade pipe

## CONFORMANCES

<b>AWS A5:</b>	E7016-1 H4, E7016-H4
<b>ABS:</b>	E7016-H4
<b>CWB/CSA:</b>	E4916-H4

## WELDING POSITIONS

All

## DIAMETERS / PACKAGING

Diameter mm (in)	Length in (mm)	10 lb (4.5 kg) Easy Open Can 30 lb (13.6 kg) Master Carton	50 lb (22.7 kg) Easy Open Can
2.5 (3/32)	14 (350)	ED033835	ED030916
3.2 (1/8)	14 (350)	ED033836	ED030917
4.0 (5/32)	18 (450)	ED033837	ED030918

## MECHANICAL PROPERTIES<sup>(1)</sup> – As Required per AWS A5.1

	Yield Strength <sup>(2)</sup> MPa (ksi)	Tensile Strength MPa (ksi)	Elongation %	Charpy V-Notch J (ft·lbf)	
				@ -46°C (-50°F)	@ -40°C (-40°F)
<b>Requirements</b> - AWS E7016-1 H4	400 (58) min	490 (70) min	22 min	27 (20) min	Not Specified
<b>Typical Results<sup>(3)</sup></b> - As-Welded	420-470 (61-68)	530-570 (76-83)	30-32	75-125 (55-92)	99-141 (73-104)

## DEPOSIT COMPOSITION<sup>(1)</sup> – As Required per AWS A5.1

	%C	%Mn	%Si	%P	%S	%Ni
<b>Requirements</b> - AWS E7016-1 H4	0.15 max	1.60 max.	0.75 max	0.035 max	0.035 max	0.30 max
<b>Typical Results<sup>(3)</sup></b> - As-Welded	0.04-0.08	1.10-1.60	0.39-0.67	0.005-0.020	0.004-0.012	< 0.07
	%Cr	%Mo	%V	%Mn + Ni + Cr + Mo + V	Diffusible Hydrogen (mL/100g weld metal)	
<b>Requirements</b> - AWS E7016-1 H4	0.20 max	0.30 max	0.08 max	1.75 max	4 max	
<b>Typical Results<sup>(3)</sup></b> - As-Welded	0.01-0.07	0.01-0.03	0.01-0.02	1.14-1.71	1-4	

## TYPICAL OPERATING PROCEDURES

Polarity <sup>(4)</sup>	Current (Amps)		
	2.5 mm (3/32 in)	3.2 mm (1/8 in)	4.0 mm (5/32 in)
DC± <sup>(5)</sup>	55-105	75-135	120-170
AC	60-115	80-150	120-185

<sup>(1)</sup>Typical all weld metal. <sup>(2)</sup>Measured with 0.2% offset. <sup>(3)</sup>See test results disclaimer <sup>(4)</sup>Preferred polarity is listed first. <sup>(5)</sup>DC- for root pass on pipe; DC± for general welding.

# PIPELINER® 7P+

Low Alloy, Cellulosic, Pipe ▪ AWS E7010-P1

## KEY FEATURES

- Q2 Lot® - Lot Controlled Chemistry and Mechanical Properties
- High productivity in vertical down and out-of-position pipe welding
- Deep penetration
- Clean, visible weld puddle

## CONFORMANCES

**AWS A5:** E7010-G, E7010-P1  
**ABS:** E7010-P1

## WELDING POSITIONS

Designed for vertical down welding of cross-country and in-plant pipe

## TYPICAL APPLICATIONS

- Root pass welding of up to X80 grade pipe
- Hot, fill and cap pass of up to X65 grade pipe
- Vertical down welding

## DIAMETERS / PACKAGING

Diameter mm (in)	Length mm (in)	50 lb (22.7 kg) Easy Open Can
3.2 (1/8)	350 (14)	ED031611
4.0 (5/32)	350 (14)	ED031612
5.0 (3/16)	350 (14)	ED031613

## MECHANICAL PROPERTIES<sup>(1)</sup> – As Required per AWS A5.5

	Yield Strength <sup>(2)</sup> MPa (ksi)	Tensile Strength MPa (ksi)	Elongation %	Charpy V-Notch J (ft·lbf)	
				@ -29°C (-20°F)	@ -40°C (-40°F)
<b>Requirements</b> - AWS E7010-P1	415 (60) min	490 (70) min	22 min	27 (20) min	Not Specified
<b>Typical Results<sup>(3)</sup></b> - As-Welded	455-515 (66-75)	525-635 (76-92)	23-29	49-92 (36-68)	31-85 (23-63)

## DEPOSIT COMPOSITION<sup>(1)</sup> – As Required per AWS A5.5

	%C	%Mn	%Si	%P	%S
<b>Requirements</b> - AWS E7010-P1	0.20 max	1.20 max	0.60 max	0.03 max	0.03 max
<b>Typical Results<sup>(3)</sup></b> - As-Welded	0.09-0.20	0.44-0.83	0.06-0.31	0.01-0.02	0.01-0.02
	%Ni	%Cr	%Mo	%V	
<b>Requirements</b> - AWS E7010-P1	1.00 max	0.30 max	0.50 max	0.10 max	
<b>Typical Results<sup>(3)</sup></b> - As-Welded	0.58-0.90	0.02-0.05	0.04-0.21	≤ 0.01	

## TYPICAL OPERATING PROCEDURES

Polarity	Current (Amps)		
	3.2 mm (1/8 in)	4.0 mm (5/32 in)	5.0 mm (3/16 in)
DC+	65-130	100-165	130-210

<sup>(1)</sup>Typical all weld metal. <sup>(2)</sup>Measured with 0.2% offset. <sup>(3)</sup>See test results disclaimer  
 NOTE: This product contains micro-alloying elements. Additional information available upon request.

# PIPELINER® 8P+

Low Alloy, Cellulosic, Pipe ■ AWS E8010-P1

## KEY FEATURES

- Q2 Lot® - Lot Controlled Chemistry and Mechanical Properties
- High productivity in vertical down and out-of-position pipe welding
- Deep penetration
- Clean, visible weld puddle

## TYPICAL APPLICATIONS

- Root pass welding of up to X80 grade pipe
- Hot, fill and cap pass of up to X70 grade pipe

## CONFORMANCES

**AWS A5:** E8010-G, E8010-P1  
**ABS:** E8010-P1  
**CWB/CSA:** E5510-P1

## WELDING POSITIONS

Designed for vertical down welding of cross-country and in-plant pipe

## DIAMETERS / PACKAGING

Diameter mm (in)	Length in (mm)	50 lb (22.7 kg) Easy Open Can
3.2 (1/8)	14 (350)	ED030826
4.0 (5/32)	14 (350)	ED030827
5.0 (3/16)	14 (350)	ED030828

## MECHANICAL PROPERTIES<sup>(1)</sup> – As Required per AWS A5.5

	Yield Strength <sup>(2)</sup> MPa (ksi)	Tensile Strength MPa (ksi)	Elongation %	Charpy V-Notch J (ft-lbf)	
				@ -29°C (-20°F)	@ -40°C (-40°F)
<b>Requirements</b> - AWS E8010-P1	460 (67) min	550 (80) min	19 min	27 (20) min	Not Specified
<b>Typical Results<sup>(3)</sup></b> - As-Welded	475-545 (69-79)	560-670 (81-97)	20-32	49-149 (36-110)	41-119 (30-88)

## DEPOSIT COMPOSITION<sup>(1)</sup> – As Required per AWS A5.5

	%C	%Mn	%Si	%P	%S
<b>Requirements</b> - AWS E8010-P1	0.20 max	1.20 max	0.60 max	0.03 max	0.03 max
<b>Typical Results<sup>(3)</sup></b>	0.09-0.20	0.55-0.98	0.07-0.27	0.01-0.02	0.01-0.02
	%Ni	%Cr	%Mo	%V	
<b>Requirements</b> - AWS E8010-P1	1.00 max	0.30 max	0.50 max	0.10 max	
<b>Typical Results<sup>(3)</sup></b>	0.73-1.00	0.02-0.05	0.13-0.22	0.01 max.	

## TYPICAL OPERATING PROCEDURES

Polarity	Current (Amps)		
	3.2 mm (1/8 in)	4.0 mm (5/32 in)	5.0 mm (3/16 in)
DC+	65-120	100-165	130-210

<sup>(1)</sup>Typical all weld metal. <sup>(2)</sup>Measured with 0.2% offset. <sup>(3)</sup>See test results disclaimer  
 NOTE: This product contains micro-alloying elements. Additional information available on request.

# PIPELINER® ARC 80

Low Alloy, Cellulosic, Pipe ■ AWS E8010-P1

## KEY FEATURES

- Q2 Lot® Control and Tested – Lot Certificate available online.
- Excellent impact properties without the intentional addition of Boron
- Clean, visible weld puddle
- Superior puddle control

## TYPICAL APPLICATIONS

- Root pass welding of up to X80 grade pipe
- Hot, fill and cap pass welding on up to X70 grade pipe

## CONFORMANCES

**AWS A5:** E8010-G, E8010-P1  
**CWB/CSA:** E8010-P1

## WELDING POSITIONS

Designed for vertical down welding of cross-country and in-plant pipe.

## DIAMETERS / PACKAGING

Diameter	Length in (mm)	50 lb. (22.7 kg) Easy Open Can
4.0 mm (5/32 in)	14 (350)	ED034456
3/16 in <sup>(5)</sup>	14 (350)	ED034458
5.0 mm	14 (350)	ED034457

## MECHANICAL PROPERTIES<sup>(1)</sup> – As Required per AWS A5.5

	Yield Strength <sup>(2)</sup> MPa (ksi)	Tensile Strength MPa (ksi)	Elongation %	Charpy V-Notch J (ft-lbf)	
				@ -29°C (-20°F)	@ -40°C (-40°F)
<b>Requirements</b> AWS E8010-P1	460 (67) min	550 (80) min	19 min	27 (20) min	Not Specified
<b>Typical Results<sup>(3)</sup></b> As-Welded	475-545 (69-79)	560 - 670 (81-97)	19-32	49-149 (36-110)	41-119 (30-88)

## DEPOSIT COMPOSITION<sup>(1)</sup> – As Required per AWS A5.5

	%C	%Mn	%Si	%P	%S
<b>Requirements</b> AWS E8010-P1	0.20 max	1.20 max	0.60 max	0.30 max	0.03 max
<b>Typical Results<sup>(3)</sup></b>	0.09-0.20	0.55-0.98	0.07-0.27	0.01-0.02	0.01-0.02
	%Ni	%Cr	%Mo	%V	
<b>Requirements</b> AWS E8010-P1	1.00 max	0.30 max	0.50 max	0.10 max	
<b>Typical Results<sup>(3)</sup></b>	0.73-1.00	0.02-0.05	0.13-0.22	0.01 max	

## TYPICAL OPERATING PROCEDURES

Polarity <sup>(4)</sup>	Current (Amps)		
	4.0 mm (5/32 in)	3/16 in <sup>(5)</sup>	5.0 mm
DC+	100-165	125-205	130-210

<sup>(1)</sup> Typical all weld metal. <sup>(2)</sup> Measured with 0.2% offset. <sup>(3)</sup> See test results disclaimer <sup>(4)</sup> Preferred polarity is listed first. <sup>(5)</sup> Manufactured to US standard units.

# PIPELINER® 18P

Low Alloy, Low Hydrogen, Pipe ▪ AWS E8018-G H4

## KEY FEATURES

- Q2 Lot® - Control and Tested - Lot certificate available online
- Low hydrogen, vertical up capability on X70 grade pipe
- Charpy V-Notch impact toughness tested to -46°C (-50°F)

## TYPICAL APPLICATIONS

- Fill and cap pass welding of up to X70 grade pipe

## CONFORMANCES

<b>AWS A5.5:</b>	E8018-G H4
<b>ASME SFA-A5.5:</b>	E8018-G H4
<b>ABS:</b>	E8018-G

## WELDING POSITIONS

All, except vertical down

## DIAMETERS / PACKAGING

Diameter mm (in)	Length in (mm)	10 lb (4.5 kg) Easy Open Can 30 lb (13.6 kg) Master Carton
3.2 (1/8)	14 (350)	ED032620
4.0 (5/32)	14 (350)	ED032621

## MECHANICAL PROPERTIES<sup>(1)</sup> - As required per AWS A5.5

	Yield Strength <sup>(2)</sup> MPa (ksi)	Tensile Strength MPa (ksi)	Elongation %	Charpy V-Notch J (ft·lbf)	
				@ -29°C (-20°F)	@ -46°C (-50°F)
<b>Requirements</b> - AWS E8018-G H4	460 (67) min	550 (80) min	19 min	Not Specified	Not Specified
<b>Typical Results</b> <sup>(3)</sup> - As-Welded	515-655 (75-95)	620-710 (90-103)	24-32	96-167 (71-123)	50-121 (37-89)

## DEPOSIT COMPOSITION<sup>(1)</sup> - As Required per AWS A5.5

	%C	%Mn	%Si	%P	%S	%Ni <sup>(4)</sup>
<b>Requirements</b> - AWS E8018-G H4	Not Specified	1.00 min	0.80 min	0.03 max	0.03 max	0.50 min
<b>Typical Results</b> <sup>(3)</sup>	0.04-0.06	1.28-1.42	0.44-0.58	0.01-0.02	≤ 0.01	0.76-0.85
	%Cr <sup>(4)</sup>	%Mo <sup>(4)</sup>	%V <sup>(4)</sup>	%Cu <sup>(4)</sup>	Diffusible Hydrogen (mL/100g weld deposit)	
<b>Requirements</b> - AWS E8018-G H4	0.30 min	0.20 min	0.10 min	0.20 min	4 max	
<b>Typical Results</b> <sup>(3)</sup>	0.04-0.06	0.17-0.39	< 0.01	< 0.02	1-4	

## TYPICAL OPERATING PROCEDURES

Polarity <sup>(5)</sup>	Current (Amps)	
	3.2 mm (1/8 in)	4.0 mm (5/32 in)
DC+	80-145	120-185
AC	90-155	130-195

<sup>(1)</sup>Typical all weld metal. <sup>(2)</sup>Measured with 0.2% offset. <sup>(3)</sup>See test results disclaimer <sup>(4)</sup>In order to meet the alloy requirements of the "G" Designation, the undiluted weld metal shall have the minimum of at least one of the elements listed. <sup>(5)</sup>Preferred polarity is listed first.



# PIPELINER® LH-D80

Low Alloy, Low Hydrogen, Pipe ▪ AWS E8045-P2 H4R

## KEY FEATURES

- Q2 Lot® - Control and Tested - Lot certificate available online
- Durable coating
- NACE MR0175 compliant for sour gas applications
- 80% higher productivity over traditional vertical-up pipe welding

## TYPICAL APPLICATIONS

- Fill and cap pass welding on up to X70 grade pipe
- Pipe repair
- Hot tapping

## CONFORMANCES

**AWS A5:** E8045-P2 H4R  
**ABS:** E8045-P2 H4R  
**CWB/CSA:** E8045-P2 H4R

## WELDING POSITIONS

Vertical Down

## DIAMETERS / PACKAGING

Diameter mm (in)	Length mm (in)	10 lb (4.5 kg) Easy Open Can 30 lb (13.6 kg) Master Carton
4.0 (5/32)	350 (14)	ED032627
4.5 (11/64)	350 (14)	ED032628

## MECHANICAL PROPERTIES<sup>(1)</sup> – As Required per AWS A5.5

	Yield Strength <sup>(2)</sup> MPa (ksi)	Tensile Strength MPa (ksi)	Elongation %	Charpy V-Notch J (ft-lbf)	
				@ -29°C (-20°F)	@ -46°C (-50°F)
<b>Requirements</b> - AWS E8045-P2 H4R	460 (67) min	550 (80) min	19 min	27 (20) min	Not Specified
<b>Typical Results<sup>(3)</sup></b> - As-Welded	485-515 (70-75)	570-600 (83-87)	26-31	75-125 (55-92)	50-95 (37-70)

## DEPOSIT COMPOSITION<sup>(1)</sup> – As Required per AWS A5.5

	%C	%Mn	%Si	%P	%S
<b>Requirements</b> - AWS E8045-P2 H4R	0.12 max	0.90-1.70	0.80 max	0.03 max	0.03 max
<b>Typical Results<sup>(3)</sup></b> - As-Welded	0.04-0.06	1.10-1.25	0.35-0.50	≤ 0.01	≤ 0.01
	%Ni	%Cr	%Mo	%V	Diffusible Hydrogen (mL/100g weld deposit)
<b>Requirements</b> - AWS E8045-P2 H4R	1.00 max	0.20 max	0.50 max	0.05 max	4 max
<b>Typical Results<sup>(3)</sup></b> - As-Welded	≤ 0.04	≤ 0.05	≤ 0.02	≤ 0.01	2-4

## TYPICAL OPERATING PROCEDURES

Polarity	Current (Amps)		
	3.2 mm (1/8 in)	4.0 mm (5/32 in)	4.5 mm (11/64 in)
DC+	120-170	170-250	200-300

<sup>(1)</sup>Typical all weld metal. <sup>(2)</sup>Measured with 0.2% offset. <sup>(3)</sup>See test results disclaimer  
 NOTE: This product contains micro-alloying elements. Additional information available on request.

# PIPELINER® LH-D90

Low Alloy, Low Hydrogen, Pipe ▪ AWS E9045-P2 H4R

## KEY FEATURES

- Q2 Lot® - Certificates showing actual deposit chemistry and mechanical properties available online
- Durable coating
- NACE MR0175 compliant for sour gas applications
- 80% higher productivity over traditional vertical-up pipe welding

## TYPICAL APPLICATIONS

- Fill and cap pass welding of up to X80 grade pipe
- Pipe repair
- Hot tapping

## DIAMETERS / PACKAGING

Diameter mm (in)	Length in (mm)	10 lb (4.5 kg) Easy Open Can 30 lb (13.6 kg) Master Carton
3.2 (1/8)	14 (350)	ED032629
4.0 (5/32)	14 (350)	ED032630
4.5 (11/64)	14 (350)	ED032631

## CONFORMANCES

<b>AWS A5:</b>	E9045-P2 H4R
<b>ABS:</b>	E9045-P2 H4R
<b>CWB/CSA:</b>	E9045-P2 H4R

## WELDING POSITIONS

Vertical Down

## MECHANICAL PROPERTIES<sup>(1)</sup> – As Required per AWS A5.5

	Yield Strength <sup>(2)</sup> MPa (ksi)	Tensile Strength MPa (ksi)	Elongation %	Charpy V-Notch J (ft·lbf)	
				@ -29°C (-20°F)	@ -46°C (-50°F)
<b>Requirements</b> - AWS E9045-P2 H4R	530 (77) min	620 (90) min	17 min	27 (20) min	Not Specified
<b>Typical Results</b> <sup>(3)</sup> - As-Welded	550-600 (80-87)	625-670 (91-97)	26-31	75-125 (55-92)	50-95 (37-70)

## DEPOSIT COMPOSITION<sup>(1)</sup> – As Required per AWS A5.5

	%C	%Mn	%Si	%P	%S
<b>Requirements</b> - AWS E9045-P2 H4R	0.12 max	0.90-1.70	0.80 max	0.03 max.	0.03 max
<b>Typical Results</b> <sup>(3)</sup> - As-Welded	0.04-0.06	1.15-1.35	0.35-0.55	≤ 0.01	≤ 0.01
	%Ni	%Cr	%Mo	%V	Diffusible Hydrogen (mL/100g weld deposit)
<b>Requirements</b> - AWS E9045-P2 H4R	1.00 max	0.20 max	0.50 max	0.05 max	4 max
<b>Typical Results</b> <sup>(3)</sup> - As-Welded	0.25-0.30 <sup>(4)</sup> / 0.80-1.00 <sup>(5)</sup>	≤ 0.05	0.15-0.25	≤ 0.01	2-4

## TYPICAL OPERATING PROCEDURES

Polarity	Current (Amps)		
	3.2 mm (1/8 in)	4.0 mm (5/32 in)	4.5 mm (11/64 in)
DC+	120-170	170-250	200-300

<sup>(1)</sup>Typical all weld metal. <sup>(2)</sup>Measured with 0.2% offset. <sup>(3)</sup>See test results disclaimer <sup>(4)</sup>Range for 3.2 mm (1/8 in) size only. <sup>(5)</sup>Range for 4.0 mm (5/32 in) and 4.5 mm (11/64 in) sizes.  
NOTE: This product contains micro-alloying elements. Additional information available on request.

# PIPELINER® LH-D100

Low Alloy, Low Hydrogen, Pipe ▪ AWS E10045-P2 H4R

## KEY FEATURES

- Q2 Lot® - Control and Tested - Lot certificate available online
- Durable coating
- 80% higher productivity over traditional vertical-up pipe welding

## TYPICAL APPLICATIONS

- Fill and cap pass welding of up to X90 grade pipe
- Pipe repair
- Hot tapping

## CONFORMANCES

**AWS A5:** E10045-P2 H4R  
**CWB/CSA:** E10045-P2 H4R

## WELDING POSITIONS

Vertical Down

## DIAMETERS / PACKAGING

Diameter mm (in)	Length in (mm)	10 lb (4.5 kg) Easy Open Can 30 lb (13.6 kg) Master Carton
4.0 (5/32)	14 (350)	ED032633
4.5 (11/64)	14 (350)	ED032634

## MECHANICAL PROPERTIES<sup>(1)</sup> – As Required per AWS A5.5

	Yield Strength <sup>(2)</sup> MPa (ksi)	Tensile Strength MPa (ksi)	Elongation %	Charpy V-Notch J (ft·lbf)	
				@ -29°C (-20°F)	@ -46°C (-50°F)
<b>Requirements</b> - AWS E10045-P2 H4R	600 (87) min	690 (100) min	16 min	27 (20) min	Not Specified
<b>Typical Results<sup>(3)</sup></b> - As-Welded	620-690 (90-100)	705-750 (102-109)	21-28	75-110 (55-81)	56-85 (41-63)

## DEPOSIT COMPOSITION<sup>(1)</sup> – As Required per AWS A5.5

	%C	%Mn	%Si	%P	%S
<b>Requirements</b> - AWS E10045-P2 H4R	0.12 max	0.90 - 1.70	0.80 max	0.03 max	0.03 max
<b>Typical Results<sup>(3)</sup></b> - As-Welded	0.04-0.06	1.25-1.65	0.35-0.55	≤ 0.01	≤ 0.01
	%Ni	%Cr	%Mo	%V	Diffusible Hydrogen (mL/100g weld deposit)
<b>Requirements</b> - AWS E10045-P2 H4R	1.00 max	0.20 max	0.50 max	0.05 max	4 max
<b>Typical Results<sup>(3)</sup></b> - As-Welded	0.70-1.00	≤ 0.08	0.40-0.50	≤ 0.01	2-4

## TYPICAL OPERATING PROCEDURES

Polarity	Current (Amps)		
	3.2 mm (1/8 in)	4.0 mm (5/32 in)	4.5 mm (11/64 in)
DC+	120-170	170-250	200-300

<sup>(1)</sup>Typical all weld metal. <sup>(2)</sup>Measured with 0.2% offset. <sup>(3)</sup>See test results disclaimer  
 NOTE: This product contains micro-alloying elements. Additional information available on request.

# PIPELINER® 19P

Low Alloy, Low Hydrogen, Pipe ▪ AWS E10018-G H4R

## KEY FEATURES

- Q2 Lot® - Control and Tested - Lot certificate available online
- Charpy V-Notch impact toughness tested to -46°C (-50°F)

## TYPICAL APPLICATIONS

- Fill and cap pass welding of up to X80 grade pipe
- Low hydrogen, vertical up capability on X80 grade pipe

## CONFORMANCES

AWS A5: E10018-G-H4R

## WELDING POSITIONS

All, except vertical down

## DIAMETERS / PACKAGING

Diameter mm (in)	Length in (mm)	10 lb (4.5 kg) Easy Open Can 30 lb (13.6 kg) Master Carton
3.2 (1/8)	14 (350)	ED032622
4.0 (5/32)	14 (350)	ED032623

## MECHANICAL PROPERTIES<sup>(1)</sup> – As Required per AWS A5.5

	Yield Strength <sup>(2)</sup> MPa (ksi)	Tensile Strength MPa (ksi)	Elongation %	Charpy V-Notch J (ft·lbf)	
				@ -29°C (-20°F)	@ -46°C (-50°F)
<b>Requirements</b> - AWS E10018-G H4R	600 (87) min	690 (100) min	15 min	Not Specified	Not Specified
<b>Typical Results</b> <sup>(3)</sup> - As-Welded	660-740 (96-107)	740-825 (107-120)	20-26	91-129 (69-95)	81-111 (60-82)

## DEPOSIT COMPOSITION<sup>(1)</sup> – As Required per AWS A5.5

	%C	%Mn	%Si	%P	%S	%Ni <sup>(4)</sup>
<b>Requirements</b> - AWS E10018-G H4R	Not Specified	1.00 min	0.80 min	0.03 max	0.03 max	0.50 min
<b>Typical Results</b> <sup>(3)</sup> - As-Welded	0.03-0.05	1.44-1.78	0.34-0.57	0.01-0.02	≤ 0.01	1.92-2.36
	%Cr <sup>(4)</sup>	%Mo <sup>(4)</sup>	%V <sup>(4)</sup>	%Cu <sup>(4)</sup>	Diffusible Hydrogen (mL/100g weld deposit)	
<b>Requirements</b> - AWS E10018-G H4R	0.30 min	0.20 min	0.10 min	0.20 min	4 max	
<b>Typical Results</b> <sup>(3)</sup> - As-Welded	0.02-0.07	0.37-0.47	0.01-0.02	0.01-0.07	2-3	

## TYPICAL OPERATING PROCEDURES

Polarity <sup>(5)</sup>	Current (Amps)	
	3.2 mm (1/8 in)	4.0 mm (5/32 in)
DC+	80-155	130-210
AC	80-160	140-215

<sup>(1)</sup>Typical all weld metal. <sup>(2)</sup>Measured with 0.2% offset. <sup>(3)</sup>See test results disclaimer <sup>(4)</sup>In order to meet the alloy requirements of the "G" group, the undiluted weld metal shall have the minimum of at least one of the elements listed. <sup>(5)</sup>Preferred polarity is listed first.

# PIPELINER® 70S-6

Mild & Low Alloy Steel Pipe ■ AWS ER70S-6

## KEY FEATURES

- An engineered alloy providing superior impact toughness at low temperatures
- Q2 Lot® - Certificates showing actual wire composition and actual mechanical properties available online
- Microguard® Ultra provides superior feeding and arc stability throughout all four quadrants of the pipe
- ProTech® packaging system

## CONFORMANCES

**AWS A5:** ER70S-6  
**ABS:** 3YSA

## TYPICAL APPLICATIONS

- Root pass welding
- Hot, fill and cap pass welding of up to X70 grade pipe

## WELDING POSITIONS

All

## SHIELDING GAS

100% CO<sub>2</sub>  
 75-95% Argon / Balance CO<sub>2</sub>  
 Flow Rate: 30 - 50 CFH

## DIAMETERS / PACKAGING

Diameter mm (in)	33lb (15kg) Plastic Spool (Vacuum Sealed Foil Bag)
1.0 (0.040)	ED036532
1.2 (0.047)	ED036535

## MECHANICAL PROPERTIES<sup>(1)</sup> – As Required per AWS A5.18

	Yield Strength <sup>(2)</sup> MPa (ksi)	Tensile Strength MPa (ksi)	Elongation %	Charpy V-Notch J (ft-lbf)	
				@-29°C (-20°F)	@-50°C (-58°F)
<b>Requirements</b> - AWS ER70S-6 As-Welded with 100% CO <sub>2</sub>	400 (58) min	485 (70) min	22 min	27 (20) min	Not Specified
<b>Typical Results</b> <sup>(3)</sup> As-Welded with 100% CO <sub>2</sub>	470 (68)	580 (84)	28	90 (66)	-
<b>Typical Results</b> <sup>(4)</sup> As-Welded with 80% Ar/20% CO <sub>2</sub>	641 (93)	710 (103)	22	123 - 144 (91-106)	87 - 110 (64-81)

## WIRE COMPOSITION – As Required per AWS A5.18

	%C	%Mn	%Si	%S	%P
<b>Requirements</b> - AWS ER70S-6	0.06-0.15	1.40-1.85	0.8-1.15	0.035 max	0.025 max
<b>Typical Results</b> <sup>(3)</sup>	0.10	1.46	0.82	0.009	0.005
	%Cr	%Ni	%Mo	%V	%Cu (Total) <sup>5</sup>
<b>Requirements</b> - AWS ER70S-6	0.15 max	0.015 max	0.15 max	0.03 max	0.50 max
<b>Typical Results</b> <sup>(3)</sup>	0.03	0.01	0	<0.003	0.17

## TYPICAL OPERATING PROCEDURES

Diameter, Polarity Shielding Gas	CTWD <sup>(6)</sup> mm (in)	Wire Feed Speed m/min (in/min)	Voltage (volts)	Approx. Current (amps)	Melt-Off Rate kg/hr (lb/hr)
<b>1.0 mm (0.040 in),</b> DC+ 75-95% Ar / Balance CO <sub>2</sub>	12-19 (1/2-3/4)	2.5-14.0 (100-550)	19-31	105-320	1.0-5.2 (2.1-11.5)
<b>1.2 mm (0.047 in),</b> DC+ 75-95% Ar / Balance CO <sub>2</sub>	12-19 (1/2-3/4)	3.2-12.7 (125-500)	19-31	145-360	1.7-6.5 (3.7-14.3)

<sup>(1)</sup>Typical all weld metal. <sup>(2)</sup>Measured with 0.2% offset. <sup>(3)</sup>See test results disclaimer <sup>(4)</sup>Results are as-welded in a simulated groove pipe joint in the flat position with X70 base plate, at 18kl/in heat input.

<sup>(5)</sup>Copper due to any coating on the electrode plus the copper content of the filler metal itself, shall not exceed the stated 0.50% max.

<sup>(6)</sup>CTWD (Contact Tip to Work Distance). Subtract 1/4 in. (6.4 mm) to calculate Electrical Stickout.

# PIPELINER® 70S-G

Mild & Low Alloy Steel Pipe ■ AWS ER70S-G

## KEY FEATURES

- Root pass capability up to API Grade X100 and hot, fill and cap pass up to X70 grade pipe
- Good back bead shape on STT® root passes
- Q2 Lot® - Certificates showing actual wire composition and actual mechanical properties available online
- Low silicon level for minimal clean-up
- ProTech® packaging system

## WELDING POSITIONS

All

## CONFORMANCES

**AWS A5:** ER70S-G  
**ISO:** G 49A Z C1 SZ

## TYPICAL APPLICATIONS

- Root pass welding of up to X100 grade pipe
- Hot, fill and cap pass welding of up to X70 grade pipe

## SHIELDING GAS

100% CO<sub>2</sub>  
 75-95% Argon / Balance CO<sub>2</sub>  
 Flow Rate: 30 - 50 CFH

## DIAMETERS / PACKAGING

Diameter mm (in)	10 lb (4.5 kg) Plastic Spool (Vacuum Sealed Foil Bag)	25 lb (11.3 kg) Plastic Spool (Vacuum Sealed Foil Bag)
1.1 (0.045)	ED030904	ED030905

## MECHANICAL PROPERTIES<sup>(1)</sup> – As Required per AWS A5.18

	Yield Strength <sup>(2)</sup> MPa (ksi)	Tensile Strength MPa (ksi)	Elongation %	Charpy V-Notch J (ft-lbf) @ -29°C (-20°F)
<b>Requirements</b> - AWS ER70S-G As-Welded with 100% CO <sub>2</sub>	400 (58) min	485 (70) min	22 min	Not Specified
<b>Typical Results</b> <sup>(3)</sup> As-Welded with 100% CO <sub>2</sub>	405-425 (59-62)	510-40 (74-78)	24-26	54-81 (40-60)

## WIRE COMPOSITION – As Required per AWS A5.18

	%C	%Mn	%Si	%S	%P	%Cu
<b>Requirements</b> - AWS ER70S-G	Not Specified					
<b>Typical Results</b> <sup>(3)</sup>	0.05-0.15	0.80-1.40	0.30-0.60	≤0.02	≤0.02	≤0.02

## TYPICAL OPERATING PROCEDURES

Diameter, Polarity	CTWD <sup>(4)</sup> mm (in)	Wire Feed Speed m/min (in/min)	Voltage (volts)	Approx. Current (amps)	Melt-Off Rate kg/hr (lb/hr)
<b>1.1 mm (0.045 in), DC+</b>	12-19 (1/2-3/4)	3.2-12.7 (125-500)	19-30	145-340	1.5-6.0 (3.4-13.2)

<sup>(1)</sup>Typical all weld metal. <sup>(2)</sup>Measured with 0.2% offset. <sup>(3)</sup>See test results disclaimer. <sup>(4)</sup>CTWD (Contact Tip to Work Distance). Subtract 1/4 in. (6.4 mm) to calculate Electrical Stickout.

# PIPELINER® 80S-G

Mild & Low Alloy Steel Pipe ■ AWS ER80S-G

## KEY FEATURES

- Root pass capability up to X100 and hot, fill and cap pass up to X80 grade pipe
- Impact toughness tested to -29°C (-20°F)
- Q2 Lot® - Certificates showing actual wire composition and actual mechanical properties available online
- MicroGuard® Ultra provides superior feeding and arc stability
- ProTech® packaging system

## WELDING POSITIONS

All

## CONFORMANCES

**AWS A5:** ER80S-G  
**ISO:** G59A 3 M21 4M31

## TYPICAL APPLICATIONS

- Root pass welding of up to API Grade X100 grade pipe
- Hot, fill and cap pass welding of up to X80 grade pipe

## SHIELDING GAS

100% CO<sub>2</sub>  
75-95% Argon / Balance CO<sub>2</sub>  
Flow Rate: 30 - 50 CFH

## DIAMETERS / PACKAGING

Diameter in (mm)	10 lb (4.5 kg) Plastic Spool (Vacuum Sealed Foil Bag)	30 lb (13.6 kg) Plastic Spool (Vacuum Sealed Foil Bag)
0.045 (1.1)	ED031493	ED031494

## MECHANICAL PROPERTIES<sup>(1)</sup>

	Yield Strength <sup>(2)</sup> MPa (ksi)	Tensile Strength MPa (ksi)	Elongation %	Charpy V-Notch J (ft·lbf) @ -30°C (-22°F)
<b>Requirements - AWS A5.18: ER80S-G</b> As-Welded with 100% CO <sub>2</sub>	Not Specified	550 (80) min	Not Specified	Not Specified
<b>Requirements - EN ISO 16834-B: G 59A 3 M21 4M31</b> As-Welded with 75-85% Ar/Balance CO <sub>2</sub>	490 (71) min.	590-790 (85-115)	16 min.	27 (20) min.
<b>Typical Results<sup>(3)</sup></b> As-Welded with 100% CO <sub>2</sub> As-Welded with 80% Ar/20% CO <sub>2</sub>	585-620 (85-90) 620-690 (90-100)	620-690 (90-100) 690-760 (100-110)	22-24 20-24	27-54 (20-40) 110-150 (80-110)

## WIRE COMPOSITION

	%C	%Mn	%Si	%S	%P	%Mo	%Cu
<b>Requirements - AWS ER80S-G</b>	Not Specified						
<b>Requirements - EN ISO 16834-B</b>	0.07-0.12	1.60-2.10	0.50-0.80	0.025 max.	0.025 max.	0.40-0.60	0.50 max
<b>Typical Results<sup>(3)</sup></b>	0.07-0.12	1.60-1.80	0.50-0.70	≤0.01	≤0.01	0.40-0.50	≤0.04

## TYPICAL OPERATING PROCEDURES

Diameter, Polarity	CTWD <sup>(4)</sup> mm (in)	Wire Feed Speed m/min (in/min)	Voltage (volts)	Approx. Current (amps)	Melt-Off Rate kg/hr (lb/hr)
<b>1.1 mm (0.045 in), DC+</b>	12-19 (1/2-3/4)	3.2-12.7 (125-500)	19-30	145-340	1.5-6.0 (3.4-13.2)

<sup>(1)</sup>Typical all weld metal. <sup>(2)</sup>Measured with 0.2% offset. <sup>(3)</sup>See test results disclaimer. <sup>(4)</sup>CTWD (Contact Tip to Work Distance). Subtract 1/4 in (6.4 mm) to calculate Electrical Stickout.

# PIPELINER® 80Ni1

Mild & Low Alloy Steel Pipe ■ AWS ER80S-G

## KEY FEATURES

- Root pass capability up to API Grade X100 and hot, fill and cap pass up to X80 grade pipe
- Q2 Lot® - Certificates showing actual wire composition and actual mechanical properties available online
- ProTech® packaging system

## WELDING POSITIONS

All

## SHIELDING GAS

75-95% Argon / Balance CO<sub>2</sub>

## CONFORMANCES

<b>AWS A5:</b>	ER80S-G
<b>ABS:</b>	5YQ500SA H10
<b>CWB/CSA:</b>	ER80S-G
<b>DNV:</b>	V Y50MS H5
<b>Lloyd's Register:</b>	5Y50S H5
<b>ISO:</b>	G 50 6 M21 3Ni1, G 57A 6 M21 SZ

## TYPICAL APPLICATIONS

- Excellent wire placement for narrow groove welding
- Offshore

## DIAMETERS / PACKAGING

Diameter mm (in)	10 lb (4.5 kg) Plastic Spool (Vacuum Sealed Foil Bag)	33 lb (15 kg) Plastic Spool (Vacuum Sealed Foil Bag)
1.0 (0.040)	ED033121	ED033119
1.2 (0.047)	ED033122	ED033120

## MECHANICAL PROPERTIES<sup>(1)</sup> – As Required per AWS A5.28

	Yield Strength <sup>(2)</sup> MPa (ksi)	Tensile Strength MPa (ksi)	Elongation %	Charpy V-Notch J (ft·lbf)	
				@ -29°C (-20°F)	@ -50°C (-58°F)
<b>Requirements</b> - AWS ER80S-G As-Welded with 100% CO <sub>2</sub>	Not Specified	550 (80) min	Not Specified	Not Specified	Not Specified
<b>Typical Results<sup>(3)</sup></b> As-Welded 100% CO <sub>2</sub> As-Welded 80% Ar/20% CO <sub>2</sub>	585-620 (85-90) 620-690 (90-100)	620-690 (90-100) 690-760 (100-110)	28-29 27-28	72-92 (53-68) 99-119 (73-88)	34-61 (25-45) 69-95 (51-70)

## WIRE COMPOSITION – As Required per AWS A5.28

	%C	%Mn	%Si	%Ni <sup>(4)</sup>	%Ti	%S
<b>Requirements</b> - AWS ER80S-G <sup>(4)</sup> EN ISO 14341-A-G 3Ni1	Not Specified 0.06-0.14	Not Specified 1.00-1.60	Not Specified 0.50-0.90	≥0.50 0.80-1.50	Not Specified ≤0.15	Not Specified ≤0.020
<b>Typical Results<sup>(3)</sup></b>	0.07-0.08	1.50-1.60	0.65-0.75	0.85-0.95	≤0.10	≤0.015
	%P	%Cu	%Cr	%Mo	%V	%Al
<b>Requirements</b> - AWS ER80S-G EN ISO 14341-A-G 3Ni1	Not Specified ≤0.020	Not Specified ≤0.35	Not Specified ≤0.15	Not Specified ≤0.15	Not Specified ≤0.03	Not Specified ≤0.02
<b>Typical Results<sup>(3)</sup></b>	≤0.015	≤0.20	≤0.05	≤0.01	≤0.01	≤0.01

## TYPICAL OPERATING PROCEDURES

Diameter, Polarity Shielding Gas	CTWD <sup>(5)</sup> mm (in)	Wire Feed Speed m/min (in/min)	Voltage (volts)	Approx. Current (amps)	Melt-Off Rate kg/hr (lb/hr)
<b>1.0 mm (0.040 in)</b> , DC+ 75-95% Ar/Balance CO <sub>2</sub>	12-19 (1/2-3/4)	2.5-14.0 (100-550)	19-31	105-320	1.0-5.2 (2.1-11.5)
<b>1.2 mm (0.047 in)</b> , DC+ 75-95% Ar/Balance CO <sub>2</sub>	12-19 (1/2-3/4)	3.2-12.7 (125-500)	19-31	145-360	1.7-6.5 (3.7-14.3)

<sup>(1)</sup>Typical all weld metal. <sup>(2)</sup>Measured with 0.2% offset. <sup>(3)</sup>See test results disclaimer <sup>(4)</sup>To meet the ER80S-G classification, weld deposit must have minimum of 1 or more of the following: 0.50% Ni; 0.30% Cr or 0.20% Mo. <sup>(5)</sup>For Electrical Stickout (ESO) subtract 6.4 mm (0.25 in.) from CTWD.



# PIPELINER® NR®-207+

Low Alloy, All Position ▪ AWS E71T8-K6

## KEY FEATURES

- Vertical down hot, fill and cap pass welding of up to X70 grade pipe
- Capable of producing weld deposits with impact toughness exceeding 27 J (20 ft•lbf) at -29°C (-20°F)
- Q2 Lot® - Certificate showing actual deposit chemistry and mechanical properties available online
- High deposition rates
- ProTech® hermetically sealed packaging

## CONFORMANCES

- AWS A5:** E71T8-A2-K6, E71T8-K6  
**ABS:** E71T8-K6  
**ISO:** T49 3 T8-1 NO A-N1 H15

## TYPICAL APPLICATIONS

- Hot, fill and cap pass welding of up to X70 grade pipe

## WELDING POSITIONS

All, except vertical up

## DIAMETERS / PACKAGING

Diameter in (mm)	14 lb (6.4 kg) Coil 56 lb (25.4 kg) Hermetically Sealed Pail
5/64 (2.0)	ED030924

## MECHANICAL PROPERTIES<sup>(1)</sup> – As Required per AWS A5.29

	Yield Strength <sup>(2)</sup> MPa (ksi)	Tensile Strength MPa (ksi)	Elongation %	Charpy V-Notch J (ft•lbf) @ -29°C (-20°F)
<b>Requirements</b> - AWS E71T8-K6	400 (58) min	485-620 (70-90)	20 min	27 (20) min
<b>Typical Results<sup>(3)</sup></b> - As-Welded	425-470 (62-68)	540-565 (78-82)	29-31	119-205 (88-151)

## DEPOSIT COMPOSITION<sup>(1)</sup> - As Required per AWS A5.29

	%C	%Mn	%Si	%P	%S	
<b>Requirements</b> - AWS E71T8-K6	0.15 max	0.50-1.50	0.80 max	0.030 max	0.030 max	
<b>Typical Results<sup>(3)</sup></b>	0.04-0.06	1.18-1.33	0.24 - 0.28	≤ 0.01	≤ 0.01	
	%Ni	%Cr	%Mo	%V	%Al	%B
<b>Requirements</b> - AWS E71T8-K6	0.40-1.00	0.20 max	0.15 max.	0.05 max	1.8 max	Not Specified
<b>Typical Results<sup>(3)</sup></b>	0.78-0.93	0.02-0.03	0.01-0.02	< 0.01	0.9-1.2	< 0.001

## TYPICAL OPERATING PROCEDURES

Diameter, Polarity	CTWD <sup>(4)</sup> mm (in)	Wire Feed Speed m/min (in/min)	Voltage (volts)	Approx. Current (amps)	Melt-Off Rate kg/hr (lb/hr)
<b>5/64 in (2.0 mm), DC-</b>	19 (3/4)	1.7-3.3 (70 - 130)	18-21	210-305	2.0-3.7 (4.3-8.1)

<sup>(1)</sup>Typical all weld metal. <sup>(2)</sup>Measured with 0.2% offset. <sup>(3)</sup>See test results disclaimer <sup>(4)</sup>For electrical stickout (ESO) subtract 6.4 mm (1/4 in) from contact tip to work distance (CTWD).  
 NOTE: This product contains micro-alloying elements. Additional information available upon request.

# PIPELINER® NR®-208-P

Low Alloy, All Position ▪ AWS E81T8-G

## KEY FEATURES

- Vertical down hot, fill and cap pass welding of up to X70 grade pipe
- Designed to meet 27 J (20 ft-lbf) @ 0°C (32°F) in pipe applications
- Q2 Lot® - Certificate showing actual deposit chemistry and mechanical properties available online
- ProTech® hermetically sealed packaging
- Designed to accommodate applications requiring Nickel content of 1% max
- Excellent operator appeal for pipe applications

## CONFORMANCES

AWS A5: E81T8-A2-K11-H8 E81T8-G-H8

## TYPICAL APPLICATIONS

- Hot, fill and cap pass welding of up to X70 grade pipe
- Warm weather cross country pipe applications
- Meets requirements for NACE applications

## WELDING POSITIONS

All, except vertical up

## DIAMETERS / PACKAGING

Diameter mm (in)	6.4 kg (14 lb) Coil 25.4 kg (56 lb) Hermetically Sealed Pail
2.0 (5/64)	ED032890

## MECHANICAL PROPERTIES<sup>(1)</sup>

	Yield Strength <sup>(2)</sup> MPa (ksi)	Tensile Strength MPa (ksi)	Elongation %	Charpy V-Notch J (ft-lbf) @ -29°C (-20°F)
<b>Requirements</b> - AWS A5.29: E81T8-G	470 (68) min	550-690 (80-100)	19 min	Not Specified
<b>Typical Results</b> <sup>(3)</sup> - As-Welded	480-520 (70-75)	600-630 (87-91)	24-30	50-100 (35-75)

## DEPOSIT COMPOSITION<sup>(1)</sup>

	%C	%Mn <sup>(4)</sup>	%Si	%P	%S
<b>Requirements</b> - AWS A5.29: E81T8-G	Not Specified	0.50 min	1.00 max	0.030 max	0.030 max
<b>Typical Results</b> <sup>(3)</sup>	0.04-0.08	1.74-1.99	0.33-0.38	0.012-0.019	<0.010
	%Ni <sup>(4)</sup>	%Cr <sup>(4)</sup>	%Mo <sup>(4)</sup>	%V <sup>(4)</sup>	%Al
<b>Requirements</b> - AWS A5.29: E81T8-G	0.50 min	0.30 min	0.20 min	0.10 min	1.8 max
<b>Typical Results</b> <sup>(3)</sup>	0.65-0.95	≤0.05	≤0.03	≤0.03	0.9-1.2

## TYPICAL OPERATING PROCEDURES

Diameter, Polarity	CTWD <sup>(5)</sup> mm (in)	Wire Feed Speed m/min (in/min)	Voltage (volts)	Approx. Current (amps)	Melt-Off Rate kg/hr (lb/hr)	Deposition Rate kg/hr (lb/hr)	Efficiency (%)
2.0 mm (5/64 in) DC-	19 (3/4)	1.7-3.3 (70-130)	18-21	210-305	1.8-3.5 (4.0-7.6)	1.5-2.9 (3.3-6.4)	82-83

<sup>(1)</sup>Typical all weld metal. <sup>(2)</sup>Measured with 0.2% offset. <sup>(3)</sup>See test results disclaimer. <sup>(4)</sup>In order to meet the alloy requirements of the "G" group, the undiluted weld metal shall have not less than the minimum of at least one of the elements listed. <sup>(5)</sup>For electrical stickout (ESO) subtract 6.4 mm (1/4 in) from contact tip to work distance (CTWD).

# PIPELINER® NR®-208-XP

Low Alloy, All Position ▪ AWS E81T8-G, E81T8-A4-K12

## KEY FEATURES

- Vertical down hot, fill and cap pass welding of up to X70 grade pipe
- Capable of producing weld deposits with impact toughness exceeding 122 J (90 ft•lbf) @ -40°C (-40°F)
- Q2 Lot® - Certificate showing actual deposit chemistry and mechanical properties available online
- ProTech® hermetically sealed packaging

## CONFORMANCES

**AWS A5:** E81T8-A4-K12, E81T8-G

**ISO:** T 55 4 T8-1 NO A-G H15

## TYPICAL APPLICATIONS

- Hot, fill and cap pass welding of up to X70 grade pipe
- Cold temperature cross country pipe applications

## WELDING POSITIONS

All, except vertical up

## DIAMETERS / PACKAGING

Diameter mm (in)	14 lb (6.4 kg) Coil	
	56 lb (25.4 kg) Hermetically Sealed Pail	
1.7 (0.068)	ED036650	
2.0 (5/64)	ED031968	

## MECHANICAL PROPERTIES<sup>(1)</sup>

	Yield Strength <sup>(2)</sup> MPa (ksi)	Tensile Strength MPa (ksi)	Elongation %	Charpy V-Notch J (ft•lbf)	
				@ -29°C (-20°F)	@ -40°C (-40°F)
<b>Requirements</b> - AWS A5.29: E81T8-G AWS A5.36: E81T8-A4-K12	470 (68) min	550 - 690 (80 - 100)	19 min	Not Specified	Not Specified 27 (20) min
<b>Typical Results<sup>(3)</sup></b> - As-Welded	500-550 (73-79)	575-615 (84-89)	21-28	131-200 (97-147)	88-143 (65-105)

## DEPOSIT COMPOSITION<sup>(1)</sup>

	%C	%Mn <sup>(4)</sup>	%Si	%P	%S
<b>Requirements</b> - AWS A5.29: E81T8-G AWS A5.36: E81T8-A4-K12	Not Specified 0.15 max	0.50 min 1.50 - 2.75	1.00 max 0.80 max	0.030 max	0.030 max
<b>Typical Results<sup>(3)</sup></b>	0.01-0.04	2.21-2.53	0.12-0.14	0.013	0.003
	%Ni <sup>(4)</sup>	%Cr <sup>(4)</sup>	%Mo <sup>(4)</sup>	%V <sup>(4)</sup>	%Al <sup>(4)</sup>
<b>Requirements</b> - AWS A5.29: E81T8-G AWS A5.36: E81T8-A4-K12	0.50 min 0.75 - 2.00	0.30 min 0.20 max	0.20 min 0.50 max	0.10 min 0.05 max	1.8 max
<b>Typical Results<sup>(3)</sup></b>	1.04-1.26	0.04-0.07	<0.02	<0.006	0.9-1.2

## TYPICAL OPERATING PROCEDURES

Diameter, Polarity	CTWD <sup>(5)</sup> mm (in)	Wire Feed Speed m/min (in/min)	Voltage (volts)	Approx. Current (amps)	Melt-Off Rate kg/hr (lb/hr)	Deposition Rate kg/hr (lb/hr)	Efficiency (%)
<b>1.7mm (0.068 in) DC-</b>	19 (3/4)	1.7-3.8 (70-150)	16-22	165-250	1.4-3.1 (3.1-6.8)	1.1-2.5 (2.5-5.5)	78-81
<b>2.0 mm (5/64 in) DC-</b>	19 (3/4)	1.7-3.3 (70-130)	17-20	195-295	1.8-3.5 (4.0-7.6)	1.5-2.9 (3.3-6.4)	82-83

<sup>(1)</sup>Typical all weld metal. <sup>(2)</sup>Measured with 0.2% offset. <sup>(3)</sup>See test results disclaimer. <sup>(4)</sup>In order to meet the alloy requirements of the "G" group, the undiluted weld metal shall have not less than the minimum of at least one of the elements listed. <sup>(5)</sup>For electrical stickout (ESO) subtract 6.4 mm (1/4 in) from contact tip to work distance (CTWD).

# PIPELINER® 81M

Low Alloy, All Position ▪ AWS E81T1-GM

## KEY FEATURES

- Designed for optimal performance in automated pipe welding applications where a consistent arc length is critical.
- Flat bead shape, fast freezing slag provides consistent puddle support all the way around the pipe.
- Capable of producing weld deposits with impact toughness exceeding 27 J (20 ft•lbf) at -40°C (-40°F).
- Q2 Lot® - Certificate showing actual deposit chemistry and mechanical properties per lot available online.
- ProTech® foil bag packaging

## WELDING POSITIONS

All

## DIAMETERS / PACKAGING

Diameter mm (in)	10 lb (4.5 kg) Plastic Spool (Vacuum Sealed Foil Bag)	25 lb (11.3 kg) Plastic Spool (Vacuum Sealed Foil Bag)
1.2 (0.047)	ED033320	ED033321

## CONFORMANCES

**AWS A5:** E81T1-M21A4-K11-H4, E81T1-GM-H4  
**CWB/CSA:** E551T1-M21A4-K11-H4, E81T1-GM-H4  
**ISO:** T55 4 T1-1 M21 A-N1-U H5

## TYPICAL APPLICATIONS

- Hot, fill and cap pass welding on up to X70 grade pipe
- Fully automated pipe welding
- Meets requirements for NACE applications

## SHIELDING GAS

75 - 85% Argon / Balance CO<sub>2</sub>  
 Flow Rate: 40 - 50 CFH

## MECHANICAL PROPERTIES<sup>(1)</sup> – As Required per AWS A5.29

	Yield Strength <sup>(2)</sup> MPa (ksi)	Tensile Strength MPa (ksi)	Elongation %	Charpy V-Notch J (ft•lbf)	
				@-29°C (-20°F)	@-40°C (-40°F)
<b>Requirements</b> - AWS E81T1-GM	470 (68) min	550-690 (80-100)	19 min	Not Specified	Not Specified
<b>Typical Results</b> <sup>(3)</sup> As-Welded with 75% Ar/25% CO <sub>2</sub>	510-560 (74-81)	580-620 (84-90)	25-29	83-149 (61-110)	66-131 (49-97)

## DEPOSIT COMPOSITION<sup>(1)</sup> – As Required per AWS A5.29

	%C	%Mn <sup>(4)</sup>	%Si <sup>(4)</sup>	%P
<b>Requirements</b> - AWS E81T1-GM	Not Specified	0.50	1.00	0.030 max
<b>Typical Results</b> <sup>(3)</sup> As-Welded with 75% Ar/25% CO <sub>2</sub>	0.06-0.07	1.54-1.68	0.34-0.37	0.010-0.015
	%S	%Ni <sup>(4)</sup>	%B	Diffusible Hydrogen (mL/100g weld deposit)
<b>Requirements</b> - AWS E81T1-GM	0.030 max	0.50	Not Specified	Not Specified
<b>Typical Results</b> <sup>(3)</sup> As-Welded with 75% Ar/25% CO <sub>2</sub>	0.010-0.020	0.85	0.005-0.006	4-5

## TYPICAL OPERATING PROCEDURES

Diameter, Polarity, Shielding Gas	CTWD mm (in)	Wire Feed Speed m/min (in/min)	Voltage (volts)	Approx. Current (amps)	Melt-Off Rate kg/hr (lb/hr)
<b>1.2 mm (0.047 in)</b> , DC+, 75-85% Ar/ balance CO <sub>2</sub>	19 (3/4)	4.4-10.2 (175 - 400)	23-30	130 - 275	1.8-4.1 (3.9-9.0)

<sup>(1)</sup>Typical all weld metal. <sup>(2)</sup>Measured with 0.2% offset. <sup>(3)</sup>See test results disclaimer

<sup>(4)</sup>In order to meet the requirements of the G group, the undiluted weld metal shall have not less than the minimum specified for one or more of the elements listed.

NOTE: This product contains micro-alloying elements. Additional information available upon request.

# PIPELINER® 101M

Low Alloy, All Position ▪ AWS E101T1-GM

## KEY FEATURES

- Designed for optimal performance in automated pipe welding applications where a consistent arc length is critical
- Fast freezing slag provides consistent puddle support all the way around the pipe
- Capable of producing weld deposits with impact toughness exceeding 27 J (20 ft•lbf) at -40°C (-40°F)
- Q2 Lot® - Certificate showing actual deposit chemistry and mechanical properties per lot available online.
- ProTech® foil bag packaging

## WELDING POSITIONS

All

## CONFORMANCES

**AWS A5:** E101T1-M21A4-K11 E101T1-GM  
**ISO:** T 62 4 T1-1 M21 A-N2M2-U H5

## TYPICAL APPLICATIONS

- Hot, fill and cap pass welding on up to X80 grade pipe
- Fully automated pipe welding
- Semi-automatic pipe welding
- Meets requirements for NACE applications

## SHIELDING GAS

75-80% Argon / Balance CO<sub>2</sub>  
 Flow Rate: 40-60 CFH

## DIAMETERS / PACKAGING

Diameter mm (in)	10 lb (4.5 kg) Plastic Spool (Vacuum Sealed Foil Bag)	25 lb (11.3 kg) Plastic Spool (Vacuum Sealed Foil Bag)
1.2 (0.047)	ED033807	ED033808

## MECHANICAL PROPERTIES<sup>(1)</sup> – As Required per AWS A5.29

	Yield Strength <sup>(2)</sup> MPa (ksi)	Tensile Strength MPa (ksi)	Elongation %	Charpy V-Notch J (ft•lbf) @-40°C (-40°F)
<b>Requirements</b> - AWS E101T1-GM	610 (88) min	690-830 (100-120)	16 min	Not Specified
<b>Typical Results</b> <sup>(3)</sup> As-Welded with 75% Ar/Balance CO <sub>2</sub>	660-670 (95-97)	700-720 (101-104)	23-25	61-91 (45-68)

## DEPOSIT COMPOSITION<sup>(1)</sup> – As Required per AWS A5.29

	%C	%Mn <sup>(4)</sup>	%Si	%P	%S
<b>Requirements</b> - AWS E101T1-GM	Not Specified	0.50	1.00 max	0.030 max	0.030 max
<b>Typical Results</b> <sup>(3)</sup> As-Welded with 75% Ar/25% CO <sub>2</sub>	0.06	1.48-1.61	0.29-0.31	0.008	0.007
	%Ni <sup>(4)</sup>	%Mo <sup>(4)</sup>	%B	Diffusible Hydrogen (mL/100g weld deposit)	
<b>Requirements</b> - AWS E101T1-GM	0.50	0.20	Not Specified	Not Specified	
<b>Typical Results</b> <sup>(3)</sup> As-Welded with 75% Ar/25% CO <sub>2</sub>	0.76-0.84	0.34-0.36	0.004-0.005	4-5	

## TYPICAL OPERATING PROCEDURES

Diameter, Polarity, Shielding Gas	CTWD mm (in)	Wire Feed Speed m/min (in/min)	Voltage (volts)	Approx. Current (amps)	Melt-Off Rate kg/hr (lb/hr)
1.2 mm (0.045 in), DC+, 75-80% Ar/ balance CO <sub>2</sub>	19 (3/4)	4.4-10.2 (175-400)	23-30	130-275	1.8-4.1 (3.9-9.0)

<sup>(1)</sup>Typical all weld metal. <sup>(2)</sup>Measured with 0.2% offset. <sup>(3)</sup>See test results disclaimer

<sup>(4)</sup>In order to meet the requirements of the G group, the undiluted weld metal shall have not less than the minimum specified for one or more of the elements listed.

NOTE: This product contains micro-alloying elements. Additional information available upon request.

# PIPELINER® 111M

Low Alloy, All Position ▪ AWS E111T1-GM

## KEY FEATURES

- Designed for optimal performance in automated pipe welding applications where a consistent arc length is critical.
- Fast freezing slag provides consistent puddle support all the way around the pipe.
- Capable of producing weld deposits with impact toughness exceeding 27 J (20 ft•lbf) at -40°C (-40°F).
- Q2 Lot® - Certificate showing actual deposit chemistry and mechanical properties per lot available online.
- ProTech® foil bag packaging

## WELDING POSITIONS

All

## CONFORMANCES

AWS A5: E111T1-M21-A4-G E111T1-GM

ISO: T76 4 T1-1 M21 A-G H5

## TYPICAL APPLICATIONS

- Hot, fill and cap pass welding on X80 to X100 grade pipe
- Fully automated pipe welding
- Semi-automatic pipe welding

## SHIELDING GAS

75 - 85% Argon / Balance CO<sub>2</sub>  
Flow Rate: 40-60 CFH

## DIAMETERS / PACKAGING

Diameter mm (in)	10 lb (4.5 kg) Plastic Spool (Vacuum Sealed Foil Bag)	25 lb (11.3 kg) Plastic Spool (Vacuum Sealed Foil Bag)
1.2 (0.047)	ED033745	ED033746

## MECHANICAL PROPERTIES<sup>(1)</sup> – As Required per AWS A5.29

	Yield Strength <sup>(2)</sup> MPa (ksi)	Tensile Strength MPa (ksi)	Elongation %	Charpy V-Notch J (ft•lbf) @-40°C (-40°F)
<b>Requirements</b> - AWS E111T1-GM	680 (98) min	760-900 (110-130)	15 min	Not Specified
<b>Typical Results</b> <sup>(3)</sup> As-Welded with 75% Ar/25% CO <sub>2</sub>	680-810 (98-118)	760-900 (110-130)	19-23	48-63 (36-47)

## DEPOSIT COMPOSITION<sup>(1)</sup> – As Required per AWS A5.29

	%C	%Mn <sup>(4)</sup>	%Si <sup>(4)</sup>	%P	%S
<b>Requirements</b> - AWS E111T1-GM	Not Specified	0.50	1.00	0.030 max	0.030 max
<b>Typical Results</b> <sup>(3)</sup> As-Welded with 75% Ar/25% CO <sub>2</sub>	0.06-0.07	1.40-1.80	0.27-0.34	≤0.010	≤0.010
	%Ni <sup>(4)</sup>	%Mo <sup>(4)</sup>	%B	Diffusible Hydrogen (mL/100g weld deposit)	
<b>Requirements</b> - AWS E111T1-GM	0.50	0.20	Not Specified	Not Specified	
<b>Typical Results</b> <sup>(3)</sup> As-Welded with 75% Ar/25% CO <sub>2</sub>	1.90-2.60	0.65-0.85	0.004-0.005	4-5	

## TYPICAL OPERATING PROCEDURES

Diameter, Polarity, Shielding Gas	CTWD mm (in)	Wire Feed Speed m/min (in/min)	Voltage (volts)	Approx. Current (amps)	Melt-Off Rate kg/hr (lb/hr)
1.2 mm (0.047 in), DC+, 75-85% Ar/ balance CO <sub>2</sub>	19 (3/4)	4.4-10.2 (175 - 400)	23-30	130 - 275	1.8-4.1 (3.9-9.0)

<sup>(1)</sup>Typical all weld metal. <sup>(2)</sup>Measured with 0.2% offset. <sup>(3)</sup>See test results disclaimer

<sup>(4)</sup>In order to meet the requirements of the G group, the undiluted weld metal shall have not less than the minimum specified for one or more of the elements listed.

NOTE: This product contains micro-alloying elements. Additional information available upon request.

# PIPELINER® G90M

Low Alloy, All Position ▪ AWS E111T1-K3M-JH8

## KEY FEATURES

- Capable of producing weld deposits with impact toughness exceeding 27 J (20 ft•lbf) at -29°C (-20°F)
- Q2 Lot® - Certificate showing actual deposit chemistry available online
- High stacking efficiency
- ProTech® hermetically sealed packaging

## WELDING POSITIONS

All, except vertical down

## CONFORMANCES

**AWS A5:** E111T1-M21A2-K3-H8, E111T1-K3M-JH8

**ABS:** E111T1-K3M-JH4

## TYPICAL APPLICATIONS

- For applications requiring high strength weld metal

## SHIELDING GAS

75 - 80% Argon / Balance CO<sub>2</sub>  
Flow Rate: 40 - 50 CFH

## DIAMETERS / PACKAGING

Diameter mm (in)	10 lb (4.5 kg) Plastic Spool (Vacuum Sealed Foil Bag)	33 lb (15 kg) Plastic Spool (Vacuum Sealed Foil Bag)
1.2 (0.047)	ED032664	ED031931
1.3 (0.052)		

## MECHANICAL PROPERTIES<sup>(1)</sup> – As Required per AWS A5.29

	Yield Strength <sup>(2)</sup> MPa (ksi)	Tensile Strength MPa (ksi)	Elongation %	Charpy V-Notch J (ft•lbf) @ -29°C (-20°F)
<b>Requirements</b> - AWS E111T1-K3M-JH8	675 (98) min	760-860 (110-130)	15 min	27 (20) min
<b>Typical Results<sup>(3)</sup></b> As-Welded with 75% Ar/25% CO <sub>2</sub>	760-825 (110-120)	795-860 (115-125)	19-22	56-85 (41-63)

## DEPOSIT COMPOSITION<sup>(1)</sup> – As Required per AWS A5.29

	%C	%Mn	%Si	%P	%S	%Ni
<b>Requirements</b> - AWS E111T1-K3M-JH8	0.15 max	0.75-2.25	0.80 max	0.030 max	0.030 max	1.25-2.60
<b>Typical Results<sup>(3)</sup></b> As-Welded with 75% Ar/25% CO <sub>2</sub>	0.05-0.07	1.45-1.70	0.21-0.28	0.01-0.02	0.01-0.02	1.80-2.22
	%Cr	%Mo	%V	%B	Diffusible Hydrogen (mL/100g weld deposit)	
<b>Requirements</b> - AWS E111T1-K3M-JH8	0.15 max	0.25-0.65	0.05 max	Not Specified	8.0 max	
<b>Typical Results<sup>(3)</sup></b> As-Welded with 75% Ar/25% CO <sub>2</sub>	0.03-0.06	0.50-0.61	0.02	0.005-0.007	2-5	

## TYPICAL OPERATING PROCEDURES

Diameter, Polarity, Shielding Gas	CTWD <sup>(4)</sup> mm (in)	Wire Feed Speed m/min (in/min)	Voltage (volts)	Approx. Current (amps)	Melt-Off Rate kg/hr (lb/hr)
<b>1.2 mm (0.045 in)</b> , DC+, 75-80% Ar/ balance CO <sub>2</sub>	25 (1)	4.4-10.2 (175-400)	23-30	130-275	1.8-4.1 (3.9-9.0)
<b>1.3 mm (0.052)</b> , DC+, 75-80% Ar/ balance CO <sub>2</sub>	25 (1)	4.4-9.5 (175-375)	23-30	130-275	2.5-5.0 (5.5-11.0)

<sup>(1)</sup>Typical all weld metal. <sup>(2)</sup>Measured with 0.2% offset. <sup>(3)</sup>See test results disclaimer <sup>(4)</sup>For electrical stickout (ESO) subtract 6.4 mm (1/4 in) from contact tip to work distance (CTWD).  
NOTE: This product contains micro-alloying elements. Additional information available upon request.

# PIPE GRADES

## PIPE GRADES

Pipe grades are classified in accordance with API 5L specification. The specification established requirements for two product specification levels – PSL 1 and PSL 2. Reference API 5L for full specifications.

**PSL 1:** Includes requirements for chemistry, ductility, minimum yield strength, and minimum tensile strength.

**PSL 2:** Adds requirements for maximum yield strength, and maximum tensile strength.

### API SPECIFICATION 5L, 44TH EDITION

*Requirements for the Results of Tensile Tests for PSL 1 Pipe*

Grade	Yield Strength Minimum		Ultimate Tensile Strength Minimum	
	MPa	ksi	MPa	ksi
A25	175	25	310	45
A25P	175	25	310	45
A	210	31	335	49
B	245	36	415	60
X42	290	42	415	60
X46	320	46	435	63
X52	360	52	460	67
X56	390	57	490	71
X60	415	60	520	75
X65	450	65	535	78
X70	485	70	570	83

### API SPECIFICATION 5L, 44TH EDITION

*Requirements for the Results of Tensile Tests for PSL 2 Pipe*

Grade	Yield Strength Minimum		Yield Strength Maximum		Ultimate Tensile Strength Minimum		Ultimate Tensile Strength Maximum	
	MPa	ksi	MPa	ksi	MPa	ksi	MPa	ksi
B	245	36	450	65	415	60	760	110
X42	290	42	495	72	415	60	760	110
X46	320	46	525	76	435	63	760	110
X52	360	52	530	77	460	67	760	110
X56	390	57	545	79	490	71	760	110
X60	415	60	565	82	520	75	760	110
X65	450	65	600	87	535	78	760	110
X70	485	70	635	92	570	83	760	110
X80	555	81	705	102	625	91	825	120
X90	625	91	775	112	695	101	915	133
X100	690	100	840	122	760	110	990	144
X120	830	120	1050	152	915	133	1145	166

## COMMON PIPE JOINT DESIGNS

A common weld joint for thinner walled pipe is the “API” fitup with a 60 degree included angle, a 1.6 mm (1/16 in) and 1.6 mm (1/16 in).

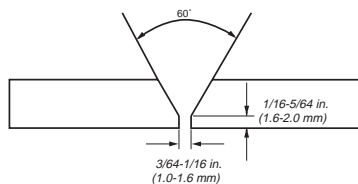

Wall thickness  $< 3/4$  in ( $< 20$  mm)

As an alternative, for thicker-walled pipe [ $> 20$  mm ( $> 3/4$  in)], a compound bevel can be used. The amount of material required to fill a compound bevel joint is less than that for a 60 degree included angle preparation, so productivity may be increased.

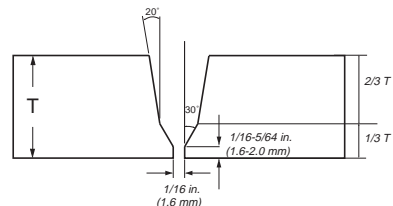

Wall thickness  $> 3/4$  in ( $> 20$  mm)



# ELECTRODE SELECTION GUIDE

## ELECTRODE SELECTION GUIDE

Products	AWS Classification	Low Strength				High Strength		
		<X60	X60	X65	X70	X80	X90	X100

### MANUAL ELECTRODES

#### Stick (SMAW) Electrodes - Cellulosic

Pipelinor® 6P+	E6010	R+F	R+F	R	R	R		
Pipelinor® 7P+	E7010-P1		R+F	R+F	R	R		
Pipelinor® 8P+	E8010-P1		R+F	R+F	R+F	R		

#### Stick (SMAW) Electrodes - Basic, Low Hydrogen, Vertical Up

Pipelinor® 16P	E7016 H4	R	R	R	R	R	R	R
Pipelinor® 18P	E8018-G H4R		F	F	F			
Pipelinor® 19P	E10018-G H4R			F	F	F	F	

#### Stick (SMAW) Electrodes - Basic, Low Hydrogen, Vertical Down

Pipelinor® LH-D80	E8045-P2 H4R		F	F	F			
Pipelinor® LH-D90	E9045-P2 H4R			F	F	F		
Pipelinor® LH-D100	E10045-P2 H4R				F	F	F	

### SEMI-AUTOMATIC / AUTOMATIC

#### MIG (GMAW) Wires - Solid

Pipelinor® 70S-G	ER70S-G	R+F	R+F	R+F	R+F	R	R	R
Pipelinor® 80S-G	ER80S-G		R+F	R+F	R+F	R+F	R	R
Pipelinor® 80Ni1	ER80S-G		R+F	R+F	R+F	R+F	R	R

#### Flux-Cored (FCAW-S) Wires - Self-Shielded

Pipelinor® NR®-207+	E71T8-K6	F	F	F				
Pipelinor® NR®-208-P	E81T8-G		F	F	F			
Pipelinor® NR®-208-XP	E81T8-G		F	F	F			

#### Flux-Cored (FCAW-G) Wires - Gas-Shielded

Pipelinor® 81M	E81T1-GM	F	F	F	F			
Pipelinor® 101M	E101T1-GM		F	F	F	F		
Pipelinor® 111M	E111T1-GM					F	F	F

R = Root Pass Only   R+F = Root & Fill Passes   F = Fill Pass Only

# LH-D80/90/100

## Welding Guidelines

### PIPELINER® LH-D WELDING - HELPFUL HINTS

Pipeliners® LH-D80, LH-D90 and LH-D100 are low hydrogen, high deposition electrodes specially designed for the vertical down welding of pipe. They are recommended for fill and cap pass welding of up to X70, X80 and X90 pipe, as well as pipe repair and hot tapping applications. For low diffusible hydrogen, high productivity and operator appeal — choose Pipeliners® LH-D electrodes.

### Use Recommended Starting and Stopping Techniques

Porosity can be the result of incorrect starting or stopping techniques. Refer to Diagram #2 and #5 below.

### Make Sure Operating Procedures are Correct

Pipeliners® LH-D electrodes recommended operating ranges are in the table below.

### TYPICAL OPERATING PROCEDURES

Polarity	Current (Amps)		
	3.2 mm (1/8 in)	4.0 mm (5/32 in)	4.5 mm (11/64 in)
DC+	120 - 170	170 - 250	200 - 300

### Do Not Re-Strike Electrode

If arc does not initiate on first try, discard electrode and start with a new one.

### Technique Tips for Weld Positions

- 12 o'clock      Decreased current and rod angle will reduce spatter.
- 3 o'clock      Increased current will help hold weld puddle up.
- 6 o'clock      A push angle and weave will help flatten bead.

### Use the Recommended Weaving Technique

Weaving too wide can cause undercutting and slag entrapment. Use a maximum weave width of approximately 2 times electrode diameter. Refer to Diagram #3 below for directions.

Welding Guidelines Diagram

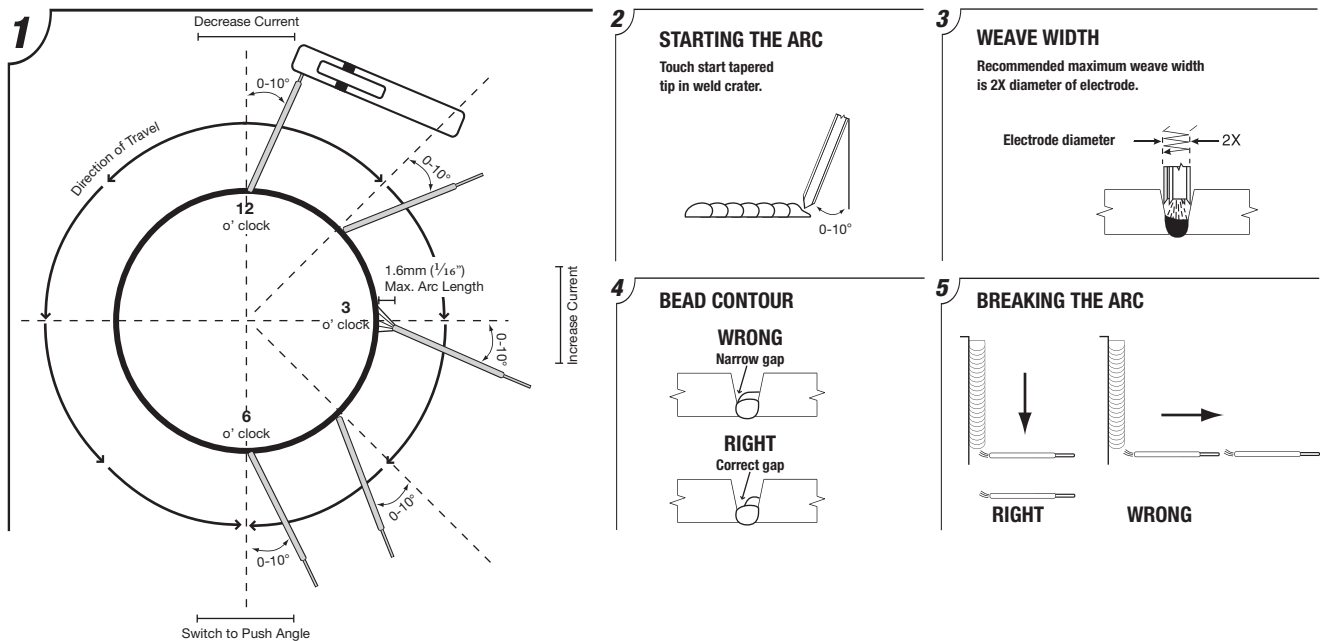

NOTE 1: This table indicates common welding electrodes by API 5L pipe grade. Final product selection should be project specific. The specific electrode recommendation depends on project specifications, including strength overmatch and minimum toughness requirements. For help in selecting the appropriate consumables and other technical questions, please contact our Pipe Welding Application Group at +1.866.635.4709 or email [appengr@lincolnelectric.com](mailto:appengr@lincolnelectric.com).

NOTE 2: Please note that the welding consumable recommendations in this table are based on weld metal strength matching the nominal pipe strength based upon API 5L minimum requirements. Recommended consumables in this chart are based upon these standards and not actual strength of pipe.

# EN AND ISO CLASSIFICATIONS

## ELECTRODE SELECTION GUIDE

Products	EN Classification	ISO Classification
<i>Stick (SMAW) Electrodes - Cellulosic</i>		
Pipeliner® 6P+	<b>EN ISO 2560</b>	<b>ISO 2560</b>
	ISO 2560-A E 42 3 C 2 1	ISO 2560-A E 42 3 C 2 1
Pipeliner® 7P+	<b>EN ISO 2560</b>	<b>ISO 2560</b>
	ISO 2560-A E46 3 1Ni C 2 1	ISO 2560-A E46 3 1Ni C 2 1
Pipeliner® 8P+	<b>EN ISO 2560</b>	<b>ISO 2560</b>
	ISO 2560-A-E 46 4 Z C 2 5 ISO 2560-B-E 55 10-G A U	ISO 2560-A-E 46 4 Z C 2 5 ISO 2560-B-E 55 10-G A U
<i>Stick (SMAW) Electrodes - Basic, Low Hydrogen, Vertical Up</i>		
Pipeliner® 16P	<b>EN ISO 2560</b>	<b>ISO 2560</b>
	ISO 2560-A-E 42 4 B 1 2 H5 ISO 2560-B-E 49 16 A U H5	ISO 2560-A-E 42 4 B 1 2 H5 ISO 2560-B-E 49 16 A U H5
Pipeliner® 18P	<b>EN ISO 2560</b>	<b>ISO 2560</b>
	ISO 2560-A-E 50 6 Mn1Ni B 3 2 H5 ISO 2560-B-E 57 18-G A H5	ISO 2560-A-E 50 6 Mn1Ni B 3 2 H5 ISO 2560-B-E 57 18-G A H5
Pipeliner® 19P	<b>EN 757</b>	<b>ISO 18275</b>
	EN 757 - E 69 5 Mn2NiMo B 3 2 H5	ISO 18275-A-E 69 5 Mn2NiMo B 3 2 H5 ISO 18275-A-E 83 18-G A H5
<i>Stick (SMAW) Electrodes - Basic, Low Hydrogen, Vertical Down</i>		
Pipeliner® LH-D80	<b>EN ISO 2560</b>	<b>ISO 2560</b>
	ISO 2560-A-E 46 4 B 4 5 H5 ISO 2560-B-E 55 15 G A H5	ISO 2560-A-E 46 4 B 4 5 H5 ISO 2560-B-E 55 15 G A H5
Pipeliner® LH-D90	<b>EN 757</b>	<b>ISO 18275</b>
	EN 757 - E 55 4 Z B 4 5 H5	ISO 18275-A-E 55 4 Z B 4 5 H5 ISO 18275-B-E 62 15 G A H5
Pipeliner® LH-D100	<b>EN 757</b>	<b>ISO 18275</b>
	EN 757 - E 62 4 Mn1NiMo B 4 5 H5	ISO 18275-A-E 62 4 Mn1NiMo B 4 5 H5 ISO 18275-B-E 69 15 G A H5

NOTE: The presented EN and ISO classifications are only the approximate classifications based on available test results. Specific EN and ISO classification tests were not performed in most cases.

# EN AND ISO CLASSIFICATIONS

## ELECTRODE SELECTION GUIDE

Products	EN Classification	ISO Classification
<i>MIG (GMAW) Wires - Solid</i>		
Pipeliner® 70S-G	<b>EN ISO 14341</b>	<b>ISO 14341</b>
	ISO 14341-A-G 38A 3 M G2Si ISO 14341-B-G 49A 3U M G6	ISO 14341-A-G 38A 3 M G2Si ISO 14341-B-G 49A 3U M G6
Pipeliner® 80S-G	<b>EN ISO 14341</b>	<b>ISO 14341</b>
	ISO 14341-A-G 50A 3 M G4Mo ISO 14341-B-G 57A 3U M G4M31	ISO 14341-A-G 50A 3 M G4Mo ISO 14341-B-G 57A 3U M G4M31
Pipeliner® 80Ni1	<b>EN ISO 14341</b>	<b>ISO 14341</b>
	ISO 14341-A-G 3Ni1	ISO 14341-A-G 3Ni1
<i>Flux-Cored (FCAW-S) Wires - Self-Shielded</i>		
Pipeliner® NR®-207+	<b>EN ISO 17632</b>	<b>ISO 17632</b>
	ISO 17632-A-42 3 1Ni Y N 5 H15 ISO 17632-B-49 3 Ni1 T8 N 1 U H15	ISO 17632-A-42 3 1Ni Y N 5 H15 ISO 17632-B-49 3 Ni1 T8 N 1 U H15
Pipeliner® NR®-208-XP	<b>EN ISO 17632</b>	<b>ISO 17632</b>
	ISO 17632-A-46 3 Z Y N 5 H15 ISO 17632-B-55 3 G T8 N1 U H15	ISO 17632-A-46 3 Z Y N 5 H15 ISO 17632-B-55 3 G T8 N1 U H15
<i>Flux-Cored (FCAW-G) Wires - Gas-Shielded</i>		
Pipeliner® 81M	<b>EN ISO 17632</b>	<b>ISO 17632</b>
	ISO 17632-A-T46 4 Mn1Ni PM 1 H5 ISO 17632-B-T554T1-1MA-N1-UH5	ISO 17632-A-T46 4 Mn1Ni PM 1 H5 ISO 17632-B-T554T1-1MA-N1-UH5
Pipeliner® 101M	<b>EN ISO 18276</b>	<b>ISO 18276</b>
	ISO 18276-A-T 62 4ZPM 1 ISO 18276-B-T694T1-1MA-N2M2-UH5	ISO 18276-A-T 62 4ZPM 1 ISO 18276-B-T694T1-1MA-N2M2-UH5
Pipeliner® 111M	<b>EN ISO 18276</b>	<b>ISO 18276</b>
	ISO 18276-A-T 69 4Z PM1- H5 ISO 18276-B-T764T1-1MA-G-H5	ISO 18276-A-T 69 4Z PM1- H5 ISO 18276-B-T764T1-1MA-G-H5

NOTE: The presented EN and ISO classifications are only the approximate classifications based on available test results. Specific EN and ISO classification tests were not performed in most cases.

# AGENCY APPROVALS

NOTE: Approvals are updated periodically.

*Consult your Lincoln Electric representative for the latest Approval/Grade revisions.*

PRODUCT	AWS Code	AWS/ASME CLASS	ABS Grade	Lloyd's Register Grade	DNV Grade	CWB/CSA	CWB/CSA
<i>Stick Electrode</i>							
Pipeliner® 6P+	A5.1	E6010	E6010	-	3	E4310	E4310
Pipeliner® 16P	A5.1	E7016 H4	-	-	-	E4916-H4	-
Pipeliner® 7P+	A5.5	E7010-P1	E7016-H4, E7016-1 H4	-	-	-	-
Pipeliner® 8P+	A5.5	E8010-P1, E8010-G	E8010-P1	-	-	E5510-P1	E5510-P1
Pipeliner® Arc 80	A5.5	E8010-P1, E8010-G	-	-	-	E5510-P1, E5510-G	E5510-P1, E5510-G
Pipeliner® 18P	A5.5	E8018-G, E8018-G H4	E8018-G	-	-	-	-
Pipeliner® LH-D80	A5.5	E8045-P2 H4R	E8045-P2 H4R	-	-	E8045-P2, H4R	E8045-P2 H4R
Pipeliner® LH-D90	A5.5	E9045-P2 H4R	E9045-P2 H4R	-	-	E9045-P2, H4R	E9045-P2 H4R
Pipeliner® 19P	A5.5	E10018-G H4R	-	-	-	-	-
Pipeliner® LH-D100	A5.5	E10045-P2 H4R	E10045-P2 H4R	-	-	E10045-P2, H4R	E10045-P2 H4R
<i>MIG &amp; TIG</i>							
Pipeliner® 70S-G	A5.18	ER70S-G	-	-	-	-	
Pipeliner® 80S-G	A5.28	ER80S-G	-	-	-	-	
Pipeliner® 80Ni1	A5.28	ER80S-G	5YQ500 H5	V Y50MS H5	5Y50S H5	-	
<i>MIG &amp; TIG</i>							
Pipeliner® NR®-207+	A5.29	E71T8-K6	-	-	-	-	
Pipeliner® NR®-208-XP	A5.29	E81T8-G	-	-	-	-	
Pipeliner® 81M	A5.29	E81T1-GM	-	-	-	-	
Pipeliner® 101M	A5.29	E101T1-GM	-	-	-	-	
Pipeliner® 111M	A5.29	E111T1-GM	-	-	-	-	

# POWER GENERATION & NUCLEAR

## *Additional Information*

Q2 Lot Certificates Center Overview ..... K-1  
 Nuclear Products / Batch Managed Overview ..... K-2

## *Stick (SMAW) Electrode*

### **Mild Steel**

Excalibur® 7018 MR® N\* ..... K-3

### **Low Alloy Steel**

Excalibur® 8018-B2 MR® ..... K-5  
 Excalibur® 9018-G MR® N ..... K-7

## *MIG (GMAW) Wire*

### **Mild Steel**

SuperArc® L-56° N\* ..... K-9

### **Low Alloy Steel**

SuperArc® AK-10™ ..... K-11  
 SuperArc® LA-75\* ..... K-13

### **Stainless Steel**

Blue Max® MIG 308L N\* ..... K-15  
 Blue Max® MIG 309L N\* ..... K-17  
 Blue Max® MIG 316L N\* ..... K-19  
 Blue Max® LNM 4462 N\* ..... K-21

## *TIG (GTAW) Cut Lengths*

### **Low Alloy Steel**

Lincoln® ER100S-1 ..... K-22

### **Stainless Steel**

Lincoln® ER308/308L N\* ..... K-23  
 Lincoln® ER309/309L N\* ..... K-24  
 Blue Max® LNT 4462 N\* ..... K-25

## *TIG (GTAW) Cut Lengths - Orbital*

### **Mild Steel**

SuperArc® Orbital TIG L-52 N\* ..... K-26  
 SuperArc® Orbital TIG L-56° N\* ..... K-27  
 Blue Max® Orbital TIG 308/308L N\* ..... K-28  
 Blue Max® Orbital TIG 309/309L N\* ..... K-29  
 Blue Max® Orbital TIG 316/316L N\* ..... K-30

### **Low Alloy Steel**

SuperArc® Orbital TIG AK-10™ ..... K-31  
 SuperArc® Orbital TIG ER80S-B2 ..... K-32  
 SuperArc® Orbital TIG ER90S-B3 ..... K-33

## *Submerged Arc (SAW) Flux & Wire Combinations*

### **Low Alloy Steel**

Lincolnweld® MIL800-H &  
 Lincolnweld® LA-84 ..... K-34  
 Lincolnweld® MIL800-H &  
 Lincolnweld® LA-100 ..... K-35

### **Stainless Steel**

Lincolnweld® P2007™ &  
 Lincolnweld® 308/308L ..... K-36  
 Lincolnweld® P2007™ &  
 Lincolnweld® 309/309L ..... K-37  
 Lincolnweld® P2007™ &  
 Lincolnweld® 316/316L ..... K-38

## *Flux-Cored (FCAW-G) Wire*

### **Mild Steel**

UltraCore® 71A85\* ..... K-39  
 UltraCore® SR-12H ..... K-41

\* These products are available as Batched Managed Inventory

Lincoln Electric gives customers the ability to view Lot numbers of a specific product online by going to the Certificate Center under the Support tab and entering the product number.

**ACCOUNT CENTER**

**INVENTORY STATUS**

10/12/2012 9:29:21 AM US Eastern Time Zone

<b>Partner Number(SoldTo):</b>	
<b>Sales Organization(SoldTo):</b>	Lincoln Electric Cleveland - US10
<b>Distribution Channel(SoldTo):</b>	Domestic - 10

	Product Number	Description	Kit Product	Requested Quantity	Available Quantity	Ship From	Notes
<input checked="" type="checkbox"/>	ED033842	.035 SUPERARC L-56 N 33# SP (Q2)		33 LB	5,676.00 LB	2012 - CLEVELAND OH US LOT NO 1068D	

**SELECT ALL**   **CLEAR ALL**

Quantities displayed represent existing inventory at time of page view. These quantities are subject to change (as additional products are manufactured and new orders are processed). Inventory for International orders may require transit time.

**CHECK PRICE**

Customers can then view Q2 Lot Certs by Lot number prior to placing an order.

**CERTIFICATE CENTER**

**CERTIFICATE CENTER**

- Global Agency Certifications
- FEMA Certificates
- AWS D1.8 Certificates
- AWS D1.1 Certificates

**Q2 Certified and Tested Lot Controlled Materials**

Search by Lot Number

Lot Number	Product Size	Product Name
1068D	.035 in.	SUPERARC L-56 N

To place and order please contact your Lincoln Electric representative to order a specific Lot of product.

**THE LINCOLN ELECTRIC COMPANY**  
22801 St. Clair Avenue  
Cleveland, Ohio 44117-1199

**STATEMENT OF TEST**

Q2 Lot# 1068D of .035 SuperArc® L-56 N was manufactured under Lot Control per ASME Section IIc SFA 5.01 / AWS A5.01 Class S3 and ASME Section III NB-2400.  
The following tests were performed on this Lot in accordance with ASME Section III NB-2400 and ASME Section IIc SFA 5.01 / AWS A5.01 Schedule K to the requirements of ASME Section IIc SFA 5.18 / AWS A5.18 classification ERT05-S. This test report is in accordance with EN10204 type 3.1 and ISO 10474 3.1.B. The product stated herein was manufactured and supplied in accordance with the Quality System Program of The Lincoln Electric Company, Cleveland, Ohio, U.S.A. as outlined in the Quality System Manual. The Quality System Program of the Lincoln Electric Company is certified to ISO 9001, is approved by VATTIV, and is accredited by ASME as evidenced by QSC-489, QSC-489-1 and QSC-489-2.

Prior to using this material for ASME Boiler and Pressure Vessel Code Section III applications please contact the Lincoln Electric Special Order Department to receive a CMTR meeting all requirements of NCA-3830.

**Test Conditions**

Electrode Size	.035
Electrode Polarity	DC+
Current (amps)	230
Ac Voltage (volts)	28
Preheat / Interpass Temp °C (°F)	261/163 (78/325)
Shielding Gas	75% Ar / 25% CO <sub>2</sub>
Heat #	CB4707

**Mechanical Properties**

Yield Strength, 2% offset method MPa (ksi)	490 (71)	<b>AWS A5.18-2005</b>
Tensile Strength MPa (ksi)	600 (87)	400 MPa (58 ksi min.)
Elongation %	29	480 MPa (70 ksi min.)

**Impacts Properties**

Average	153 (113)	27 Joules (208.-lbs.) min.
Joules @ -29°C (ft.-lbs. ave @ -20°F)	146, 157, 155 (108, 116, 114)	
Average	99 (73)	Report Only
Joules @ -40°C (ft.-lbs. ave @ -40°F)	91, 89, 118 (67, 66, 87)	

**Wire Chemistry**

% Carbon	0.10	0.05-0.15
% Manganese	1.44	1.40-1.55
% Silicon	0.85	0.80-1.15
% Phosphorus	0.008	0.025 max.
% Sulfur	0.005	0.035 max.
% Nickel	0.01	0.15 max.
% Chromium	0.03	0.15 max.
% Molybdenum	<0.01	0.15 max.
% Vanadium	<0.01	0.03 max.
% Copper (Total)	0.19	0.50 max.

**Diffusible Hydrogen**

Per AWS A4.3 (ml/100g weld metal)	1.3, 1.2, 1.7, 1.5 =1.4 Average	REPORT ONLY
-----------------------------------	---------------------------------	-------------

This is to certify that the contents of this report are correct and accurate as contained in the records of The Lincoln Electric Company.

Radiographic Test: Met Requirements  
 Test assembly constructed of ASTM A36  
 Ed Lipsky Quality Assurance Mgr. *Ed Lipsky* 10 Aug 2012  
 Tim Peck Special Products Mgr. *Tim Peck* 11 Aug 2012

## NUCLEAR PRODUCT PORTFOLIO

Nuclear Products are designated with an "N" suffix in the product name. These products have modified chemical composition and/or mechanical properties in the as welded or stress relieve condition to meet (but not limited to) specific requirements for the nuclear industry.

### "N" Designators:

- **Excalibur® 7018 MR® N** - Design modified to meet properties after 48 hours stress relief.
- **SuperArc® L-52 N and SuperArc® L-56® N** - Design modified to meet properties after stress relief.
- **Stainless Products with N Suffix** - Cobalt restriction of 0.05% max.

## WHAT IS BATCH MANAGEMENT?

Batch Management is lot controlled and tested products with full traceability throughout the manufacturing process. All batch managed products have actual certified material test reports (CMTR) for each Q2 Lot® number. Q2 Lot® certificates can be downloaded from the certificate center on the Lincoln Electric website. Order a specific lot of material, as well as order a single lot or multiple lots of material that best meet your application requirements.

Lincoln Electric's Batch Managed Inventory Program includes a complete portfolio of Q2 Lot® products: SMAW, GMAW, GTAW, Orbital TIG, and FCAW-G wires.

- EXCALIBUR®
- LINCOLN®
- SUPERARC®
- ULTRACORE®
- BLUE MAX®

Batch Managed products are represented with the words "batch" in the top left corner of the product page.

BATCH   STICK (SMAW) ELECTRODE	
<h1>EXCALIBUR® 7018 MR® N</h1> <p>Mild Steel ▪ AWS E7018</p>	
<h3>KEY FEATURES</h3> <ul style="list-style-type: none"> <li>▪ Q2 Lot® - Certificate showing actual deposit composition and actual mechanical properties available online</li> <li>▪ Available as Batch Managed Inventory</li> <li>▪ "N" Designator - design modified to meet properties after</li> </ul>	<h3>CONFORMANCES</h3> <p><b>AWS A5.1/A5.1M: 2004:</b> <b>ASME SFA-A5.1:</b></p>



# EXCALIBUR® 7018 MR® N

Mild Steel ▪ AWS E7018

## KEY FEATURES

- Q2 Lot® - Certificate showing actual deposit composition and actual mechanical properties available online
- Available as Batch Managed Inventory
- "N" Designator - design modified to meet properties after 48 hours stress relief
- Premium arc performance
- Square coating burn-off
- Easy strike and re-strike
- Effortless slag removal
- Minimal spatter for enhanced operability and clean weld surface
- Impact toughness tested to -46°C (-50°F)
- Capable of exceeding AWS minimum requirement of 480 MPa (70 ksi) tensile and 400 MPa (58 ksi) yield strength after 48 hours of stress relieving at 590-620°C (1100-1150°F)
- Capable of meeting drop weight testing requirements as commonly required for nuclear applications
- Prior to using this material for ASME Boiler and Pressure Vessel Code Section III applications, please contact the Lincoln Electric Specials Department to receive a Certified Material Test Report (CMTR) which meets all requirements of NCA-3860.
- Each rod is marked with AWS classification and LOT number

## CONFORMANCES

**AWS A5:** E7018 H4R, E7018-1 H4R  
**CWB/CSA:** E4918-H4R

## TYPICAL APPLICATIONS

- Nuclear power plant construction and maintenance
- Power generation
- Petrochemical
- Pressure vessels
- Pressure piping
- Fill and cap pass welding of up to X65 grade pipe

## ASME IX QUALIFICATION

ASME IX Qualification: QW432 F-No 4,  
 QW442 A-No 1

## WELDING POSITIONS

All, Except Vertical Down

## DIAMETERS / PACKAGING

Diameter in (mm)	Length in (mm)	8 lb (3.6 kg) Easy Open Can 24 lb (10.9 kg) Master Carton	10 lb (4.5 kg) Easy Open Can 30 lb (13.6 kg) Master Carton
3/32 (2.4)	12 (300)	ED033940	
1/8 (3.2)	14 (350)		ED033838
5/32 (4.0)	14 (350)		ED033839

**MECHANICAL PROPERTIES<sup>(1)</sup> – As Required per AWS A5.1**

	Yield Strength <sup>(2)</sup> MPa (ksi)	Tensile Strength MPa (ksi)	Elongation %	Charpy V-Notch J (ft·lbf)		
				@ -29°C (-20°F)	@ -46°C (-50°F)	@ -50°C (-60°F)
<b>Requirements</b> AWS E7018-1 H4R	400 (58) min	490 (70) min	22 min	27 (20) min	27 (20) min	Not Specified
<b>Typical Results<sup>(3)</sup></b> As-Welded	440-530 (64-77)	540-630 (79-91)	27-29	90-135 (67-233)	28-177 (21-131)	32-210 (24-155)
Stress Relieved 48 hrs @ 620°C (1150°F)	410-470 (59-68)	500-560 (72-81)	29-31	172-352 (127-260)	–	23-284 (17-210)

**DEPOSIT COMPOSITION<sup>(1)</sup> – As Required per AWS A5.1**

	%C	%Mn	%Si	%P	%S
<b>Requirements</b> AWS E7018-1 H4R	0.15 max	1.60 max	0.75 max	0.035 max	0.35 max
<b>Typical Results<sup>(3)</sup></b>	0.06 - 0.08	0.78 - 1.16	0.16 - 0.38	≤0.01	≤0.01
	%Ni	%Cr	%Mo	Diffusible Hydrogen (mL/100g weld deposit)	
<b>Requirements</b> AWS E7018-1 H4R	0.30 max	0.20 max	0.30 max	4.0 max	
<b>Typical Results<sup>(3)</sup></b>	≤0.02	≤0.03	0.20 - 0.25	1 - 3	

**TYPICAL OPERATING PROCEDURES**

Polarity <sup>(4)</sup>	Current (Amps)		
	3/32 in (2.4 mm)	1/8 in (3.2 mm)	5/32 in (4.0 mm)
DC+	70-110	90-160	130-210
AC	80-120	100-160	140-210

<sup>(1)</sup>Typical all weld metal. <sup>(2)</sup>Measured with 0.2% offset. <sup>(3)</sup>See test results disclaimer <sup>(4)</sup>Preferred polarity is listed first.

# EXCALIBUR® 8018-B2 MR®

Low Alloy Steel ▪ AWS E8018-B2 H4R

## KEY FEATURES

- Designed for welding 1.25% chromium, 0.50% molybdenum steel
- Premium arc performance
- Square coating burn-off
- Easy strike, re-strike and slag removal
- Capable of exceeding AWS minimum requirement of 550 MPa (80 ksi) tensile strength after 8 hours of stress-relieving at 690°C (1275°F)
- Meets AWS minimum requirement of 550 MPa (80 ksi) tensile and 470 MPa (68 Ksi ) yield strength after 48 hours of stress-relieving at 590-620°C (1100-1150°F) as typical in nuclear applications
- Each rod is marked with AWS classification and LOT number.

## WELDING POSITIONS

All, Except Vertical Down

## CONFORMANCES

**AWS A5:** E8018-B2, E8018-B2 H4R  
**CWB/CSA:** E5518-B2

## TYPICAL APPLICATIONS

- Power generation
- Petrochemical
- Pressure vessels
- Process piping
- Nuclear steam generators and other components

## ASME IX QUALIFICATION

ASME IX Qualification: QW432 F-No 4,  
 QW442 A-No 3

## DIAMETERS / PACKAGING

Diameter in (mm)	Length in (mm)	8 lb (3.6 kg) Easy Open Can	10 lb (4.5 kg) Easy Open Can	25 lb (11.3 kg) Easy Open Can	50 lb (22.7 kg) Easy Open Can
		24 lb (10.9 kg) Master Carton	30 lb (13.6 kg) Master Carton		
3/32 (2.4)	12 (300)	ED032878	ED032879	ED032881	ED032882 ED032883
1/8 (3.2)	14 (350)				
5/32 (4.0)	14 (350)				

**MECHANICAL PROPERTIES<sup>(1)</sup> – As Required per AWS A5.5**

	<b>Yield Strength<sup>(2)</sup></b> MPa (ksi)	<b>Tensile Strength</b> MPa (ksi)	<b>Elongation</b> %	<b>Charpy V-Notch</b> J (ft•lbf) @ -29°C (-20°F)
<b>Requirements</b> AWS E8018-B2 H4R	460 (67) min	550 (80) min	19 min	Not Specified
<b>Typical Results<sup>(3)</sup> – As-Welded</b>				
Stress-Relieved 1 hr @ 690°C (1275°F)	540-585 (78-85)	640-685 (93-99)	24-26	71-127 (52-94)
Stress-Relieved 8 hrs @ 690°C (1275°F) <sup>(4)</sup>	495-540 (72-78)	605-640 (88-93)	25-28	64-127 (47-83)
Stress-Relieved 48 hrs @ 621°C (1150°F) <sup>(4)</sup>	560-580 (81-84)	660-680 (96-99)	24-25	28-197 (21-145)

**DEPOSIT COMPOSITION<sup>(1)</sup> – As Required per AWS A5.5**

	<b>%C</b>	<b>%Mn</b>	<b>%Si</b>	<b>%P</b>
<b>Requirements</b> AWS E8018-B2 H4R	0.05-0.12	0.90 max	0.80 max	0.03 max
<b>Typical Results<sup>(3)</sup></b>	0.08-0.11	0.65-0.80	0.35-0.55	≤ 0.02
	<b>%S</b>	<b>%Cr</b>	<b>%Mo</b>	<b>Diffusible Hydrogen</b> (mL/100g weld metal)
<b>Requirements</b> AWS E8018-B2 H4R	0.03 max	1.00-1.50	0.40-0.65	4.0 max
<b>Typical Results<sup>(3)</sup></b>	≤ 0.01	1.05-1.30	0.40-0.60	2-4

**TYPICAL OPERATING PROCEDURES**

<b>Polarity<sup>(5)</sup></b>	<b>Current (Amps)</b>		
	<b>3/32 in (2.4 mm)</b>	<b>1/8 in (3.2 mm)</b>	<b>5/32 in (4.0 mm)</b>
DC+	60-110	85-160	110-210
AC	65-120	90-170	115-220

<sup>(1)</sup>Typical all weld metal. <sup>(2)</sup>Measured with 0.2% offset. <sup>(3)</sup>See test results disclaimer. <sup>(4)</sup>Industry Specific Data (Not AWS Requirement). <sup>(5)</sup>Preferred polarity is listed first.

# EXCALIBUR® 9018-G MR N

Low Alloy Steel ▪ AWS E9018-G H4R

## KEY FEATURES

- Q2 Lot® - Certificate showing actual deposit composition and actual mechanical properties available online
- "N" Designator - design modified to meet properties after 48 hours stress relief
- Premium arc performance
- Square coating burn-off
- Easy strike and re-strike
- Effortless slag removal
- Capable of exceeding AWS minimum requirement of 620 MPa (90 ksi) tensile and 540 MPa (68 ksi) yield strength after 48 hours of stress relieving at 590-620°C (1100-1150°F)
- Capable of meeting drop weight testing requirements as commonly required for nuclear applications
- Prior to using this material for ASME Boiler and Pressure Vessel Code Section III applications, please contact the Lincoln Electric Specials Department to receive a Certified Material Test Report (CMTR) which meets all requirements of NCA-3860
- Each rod is marked with AWS classification and LOT number

## CONFORMANCES

AWS A5: E9018-G H4R

## TYPICAL APPLICATIONS

- Nuclear power plant components
- High strength steel, such as HY-80, HY-90 and ASTM A514, A508, A533
- DC welding
- Pressure Vessels

## ASME IX QUALIFICATION

ASME IX Qualification: QW432 F-No 4,  
QW442 A-No 10

## WELDING POSITIONS

All, Except Vertical Down

## DIAMETERS / PACKAGING

Diameter in (mm)	Length in (mm)	8 lb (3.6 kg) Easy Open Can 24 lb (10.9 kg) Master Carton	10 lb (4.5 kg) Easy Open Can 30 lb (13.6 kg) Master Carton
3/32 (2.4)	12 (300)	ED033897	
1/8 (3.2)	14 (350)		ED033898
5/32 (4.0)	14 (350)		ED033865

**MECHANICAL PROPERTIES<sup>(1)</sup> – As Required per AWS A5.1**

	Yield Strength <sup>(2)</sup> MPa (ksi)	Tensile Strength MPa (ksi)	Elongation %	Charpy V-Notch J (ft·lbf)	
				@ -40 °C (-40 °F)	@ -50 °C (-60 °F)
<b>Requirements</b> AWS E9018-G H4R	620 (90) min	530 (77) min	17 min	Not Required	Not Required
<b>Typical Results<sup>(3)</sup></b> As-Welded	590-680 (85-98)	680-770 (99-112)	21-26	74-130 (55-96)	51-111 (38-82)
Stress Relieved 48 hrs @ 620 °C (1150 °F) on HY-80	540-590 (78-85)	630-670 (91-97)	25-28	33-123 (25-91)	27-98 (20-73)

**DEPOSIT COMPOSITION<sup>(1)</sup> – As Required per AWS A5.5**

	%C	%Mn	%Si	%P	%S	%Ni <sup>(4)</sup>
<b>Requirements</b> AWS E9018-G H4R	Not Required	1.00 min	0.80 min	0.03 max	0.03 max	0.50 min
<b>Typical Results<sup>(3)</sup></b>	0.09 - 0.12	0.79 - 1.22	0.22 - 0.43	≤0.01	≤0.01	1.54 - 1.79
	%Cr <sup>(4)</sup>	%Mo <sup>(4)</sup>	%V <sup>(4)</sup>	%Cu <sup>(4)</sup>	Diffusible Hydrogen (mL/100g weld deposit)	
<b>Requirements</b> AWS E9018-G H4R	0.30 min	0.20 min	0.10 min	0.20 min	4.0 max	
<b>Typical Results<sup>(3)</sup></b>	≤0.03	0.29 - 0.31	≤0.02	≤0.02	1 - 3	

**TYPICAL OPERATING PROCEDURES**

Polarity <sup>(5)</sup>	Current (Amps)		
	3/32 in (2.4 mm)	1/8 in (3.2 mm)	5/32 in (4.0 mm)
DC+	70-110	90-160	130-210
AC	80-120	100-160	140-210

<sup>(1)</sup>Typical all weld metal. <sup>(2)</sup>Measured with 0.2% offset. <sup>(3)</sup>See test results disclaimer<sup>(4)</sup>In order to meet the alloy requirements of the "G" designation, the undiluted weld metal shall have the minimum of at least one of the elements listed. <sup>(5)</sup>Preferred polarity is listed first.

# SUPERARC® L-56® N

Mild Steel ▪ AWS ER70S-6

## KEY FEATURES

- Q2 Lot® - Certificates showing actual wire composition and mechanical properties available online
- Available as Batch Managed Inventory
- "N" Designator - design modified to meet properties after stress relief
- Uniquely alloyed product to obtain higher strength levels
- High levels of manganese and silicon deoxidizers tolerate medium to heavy mill scale surfaces
- Excellent toe-wetting provides optimal bead appearance
- Copper coated for long contact tip life
- Supports short-circuiting, globular, axial spray and pulsed spray transfer
- MicroGuard® Ultra provides superior feeding and arc stability
- Each spool is identified with AWS classification and LOT number

## WELDING POSITIONS

All

## CONFORMANCES

**AWS A5.18:** ER70S-6  
**ASME SFA-A5.18:** ER70S-6

## TYPICAL APPLICATIONS

- Nuclear power plant construction and maintenance
- Medium to heavy mill scale base material
- Robotic or hard automation
- Structural steel

## ASME IX QUALIFICATION

ASME IX Qualification: QW432 F-No 6

## DIAMETERS / PACKAGING

Diameter in (mm)	33 lb (15 kg) Plastic Spool
0.035 (0.9)	ED033842
0.045 (1.1)	ED033843

**MECHANICAL PROPERTIES<sup>(1)</sup> – As Required per AWS A5.18**

	Yield Strength <sup>(2)</sup> MPa (ksi)	Tensile Strength MPa (ksi)	Elongation %	Charpy V-Notch J (ft·lbf)	
				@ -29°C (-20°F)	@ -40°C (-40°F)
<b>Requirements</b> - AWS ER70S-6 As-Welded with 100% CO <sub>2</sub>	400 (58) min	485 (70) min	22 min	27 (20) min	Not Specified
<b>Typical Results<sup>(3)</sup></b> As-Welded with 100% CO <sub>2</sub>	440 (64)	560 (81)	29	71 (52)	61 (45)
Stress Relieved 1 hr. @ 621°C (1150°F) <sup>(4)</sup>	395 (57)	510 (74)	29	95 (70)	68 (50)
As-Welded with 75% Ar/25% CO <sub>2</sub>	460 (67)	565 (82)	27	82 (60)	72 (53)
Stress Relieved 1 hr. @ 621°C (1150°F) <sup>(4)</sup>	415 (60)	540 (78)	31	140 (103)	122 (90)
As-Welded with 90% Ar/10% CO <sub>2</sub>	470 (68)	580 (84)	28	119 (88)	78 (57)
Stress Relieved 1 hr. @ 621°C (1150°F) <sup>(4)</sup>	440 (64)	550 (80)	32	183 (135)	156 (115)
As-Welded with 98% Ar/2% O <sub>2</sub>	455 (66)	565 (82)	27	122 (90)	108 (80)
Stress Relieved 1 hr. @ 621°C (1150°F) <sup>(4)</sup>	415 (60)	545 (79)	34	190 (140)	176 (130)

**WIRE COMPOSITION – As Required per AWS A5.18**

	%C	%Mn	%Si	%S	%P
<b>Requirements</b> - AWS ER70S-6	0.06-0.15	1.40-1.85	0.80-1.15	0.035 max	0.025 max
<b>Typical Results<sup>(3)</sup></b>	0.08-0.10	1.42-1.60	0.81-0.87	0.006-0.010	0.004-0.010
	%Cr	%Ni	%Mo	%V	%Cu (Total) <sup>(4)</sup>
<b>Requirements</b> - AWS ER70S-6	0.15 max	0.15 max	0.15 max	0.03 max.	0.50 max
<b>Typical Results<sup>(3)</sup></b>	0.01-0.05	≤ 0.04	≤ 0.01	< 0.01	0.17-0.22

**TYPICAL OPERATING PROCEDURES**

Diameter, Polarity Shielding Gas	CTWD mm (in)	Wire Feed Speed m/min (in/min)	Voltage (volts)	Approx. Current (amps)	Melt-Off Rate kg/hr (lb/hr)
<b>0.035 in (0.9 mm), DC+</b>					
Short Circuit Transfer 100% CO <sub>2</sub>	9-12 (3/8-1/2)	2.5 (100)	18	80	0.7 (1.6)
		3.8 (150)	19	120	1.1 (2.4)
		6.4 (250)	22	175	1.8 (4.0)
Spray Transfer 90% Ar/10% CO <sub>2</sub>	12-19 (1/2-3/4)	9.5 (375)	23	195	2.7 (6.0)
		12.7 (500)	29	230	3.6 (8.0)
		15.2 (600)	30	275	4.4 (9.6)
<b>0.045 in (1.1 mm), DC+</b>					
Short Circuit Transfer 100% CO <sub>2</sub>	12-19 (1/2-3/4)	3.2 (125)	19	145	1.5 (3.4)
		3.8 (150)	20	165	1.8 (4.0)
		5.1 (200)	21	200	2.5 (5.4)
		8.9 (350)	27	285	4.2 (9.2)
Spray Transfer 90% Ar/10% CO <sub>2</sub>	12-19 (1/2-3/4)	12.1 (475)	30	335	5.7 (12.5)
		12.7 (500)	30	340	6.0 (13.2)

<sup>(1)</sup>Typical all weld metal. <sup>(2)</sup>Measured with 0.2% offset. <sup>(3)</sup>See test results disclaimer <sup>(4)</sup>Industry specific data, not required by AWS.  
NOTE: Additional test data available upon request.



# SUPERARC® AK-10™

Low Alloy, Copper Coated ▪ AWS ER100S-G

## KEY FEATURES

- Capable of producing welds with 690 MPa (100 ksi) tensile strength
- Suitable for use where consumables with less than 1% Ni are required
- Batch Managed Inventory
- Superior feeding and arc stability

## WELDING POSITIONS

All

## SHIELDING GAS

- 100% CO<sub>2</sub>
- 75-95% Argon / Balance CO<sub>2</sub>
- 95-98% Argon / Balance O<sub>2</sub>
- Flow rate: 30-50CFH

## CONFORMANCES

**AWS A5.28:** ER100S-G

**ASME SFA-5.28:** ER100S-G

## TYPICAL APPLICATIONS

- NACE applications
- Oil tools
- Riser systems
- High-strength pipe

## TYPICAL BASE METALS

HY-80 or HY-100 per MIL-S-16216, A514 Grade B or P, AISI 4130 or 8620, API X-70 or X-80

## DIAMETERS / PACKAGING

Diameters in (mm)	33 lb. (15kg) Steel Spool	500 lb. (227kg) Accu-Trak® Drum
0.035 (0.9)	ED034894	ED034896
0.045 (1.1)	ED034895	ED034897

**MECHANICAL PROPERTIES** – As Required per AWS A5.28

	Yield Strength <sup>(1)</sup> MPa (ksi)	Tensile Strength MPa (ksi)	Elongation (%)	Charpy V-Notch J (ft-lbf) -40 °C (40 °F)	Charpy V-Notch J (ft-lbf) -51 °C (60 °F)
<b>Requirements</b> AWS A5.28: ER100S-G As-Welded with 90% Ar/10% CO <sub>2</sub>	Not Specified	690 (100) min	Not Specified	Not Specified	Not Specified
<b>Typical Results<sup>(2)</sup></b> As-Welded with 90% Ar/10% CO <sub>2</sub>	709 (103)	802 (116)	21	86 (64)	85 (63)
Stress Relieved 1 hr. @ 621 °C (1150 °F) with 90% Ar/10% CO <sub>2</sub>	627 (91)	723 (105)	25	113 (83)	100 (73)

**WIRE COMPOSITION** – As Required per AWS A5.28

	%C	%Mn	%Si	%Ni
<b>Requirements</b> - AWS A5.28: ER100S-G	–	–	–	(A)
<b>Typical Results<sup>(2)</sup></b>	0.10	1.55	0.57	0.88
	%Mo	%Cr	%S	%P
<b>Requirements</b> - AWS A5.28: ER100S-G	(A)	(A)	–	–
<b>Typical Results<sup>(2)</sup></b>	0.47	0.28	< 0.005	0.01
	%V	%Al	%Cu	
<b>Requirements</b> - AWS A5.28: ER100S-G	–	–	–	
<b>Typical Results<sup>(2)</sup></b>	< 0.003	0.003	0.12	

<sup>(1)</sup> Measured with a 0.2% offset. <sup>(2)</sup> See test results disclaimer

(A) Must have the minimum of one or more of the following: 0.50% Ni, 0.30% Cr, or 0.20% Mo.

# SUPERARC® LA-75

Low Alloy Steel ▪ AWS ER80-Ni1

## KEY FEATURES

- Q2 Lot® - Certificates showing actual wire composition and mechanical properties available online
- Available as Batch Managed Inventory
- Capable of producing weld deposits with 550 MPa (80 ksi) tensile strength
- High toughness at low temperatures with a nominal 1% Ni or less
- MicroGuard® Ultra provides superior feeding and arc stability
- Supports short-circuiting, globular, axial spray and pulsed spray transfer

## WELDING POSITIONS

All

## CONFORMANCES

<b>AWS A5.28:</b>	ER80S-Ni1
<b>ASME SFA-A5.28:</b>	ER80S-Ni1
<b>AWS A5.17:</b>	ENi1K
<b>ABS:</b>	ER80S-Ni1
<b>CWB/CSA W48-06:</b>	ER55S-Ni1 (ER80S-Ni1)
<b>EN ISO 14341-B:</b>	G 55A 4 A SN2

## TYPICAL APPLICATIONS

- ASTM A588 weathering steel requiring good atmospheric corrosion resistance
- NACE applications
- Nuclear power plant construction and maintenance

## ASME IX QUALIFICATION

ASME IX Qualification:	QW432 F-No 6, QW442 A-No 10
------------------------	--------------------------------

## DIAMETERS / PACKAGING

Diameter in (mm)	33 lb (15 kg) Plastic Spool
0.035 (0.9)	ED033949

**MECHANICAL PROPERTIES<sup>(1)</sup> – As Required per AWS A5.28**

	Yield Strength <sup>(2)</sup> MPa (ksi)	Tensile Strength MPa (ksi)	Elongation %	Charpy V-Notch J (ft·lbf)		
				@ -29°C (-20°F)	@ -45°C (-50°F)	@ -57°C (-70°F)
<b>Requirements</b> - AWS ER80S-Ni1 As-Welded with 98% Ar/2% O <sub>2</sub>	470 (68) min	550 (80) min	24 min	Not Specified	27 (20) min	Not Specified
<b>Typical Results<sup>(3)</sup></b> As-Welded with 90% Ar/10% CO <sub>2</sub> Stress Relieved 1 hr. @ 621°C (1150° F)	475 (69) 450 (65)	580 (84) 565 (82)	28 32	119 (88) - -	82 (60) 127 (93)	35 (26) 112 (82)
As-Welded with 75% Ar/25% CO <sub>2</sub> Stress Relieved 1 hr. @ 621°C (1150° F)	495 (72) 440 (64)	595 (86) 560 (81)	27 31	49 (36) 127 (94)	54 (40) 114 (84)	- - 54 (40)
As-Welded with 98% Ar/2% O <sub>2</sub>	490 (71)	580 (84)	30	- -	103 (76)	- -

**WIRE COMPOSITION – As Required per AWS A5.28**

	%C	%Mn	%Si	%Ni	%Cr
<b>Requirements</b> - AWS ER80S-Ni1	0.12 max	1.25 max	0.40-0.80	0.80-1.10	0.15 max
<b>Typical Results<sup>(3)</sup></b>	0.07-0.08	0.94-1.04	0.54-0.58	0.88-0.98	≤ 0.04
	%Mo	%S	%P	%V	%Cu (Total) <sup>(4)</sup>
<b>Requirements</b> - AWS ER80S-Ni1	0.35 max	0.025 max	0.025 max	0.05 max	0.35 max
<b>Typical Results<sup>(3)</sup></b>	≤ 0.02	0.007 - 0.010	0.005 - 0.010	< 0.01	0.16 - 0.21

**TYPICAL OPERATING PROCEDURES**

Diameter, Polarity Shielding Gas	CTWD <sup>(5)</sup> mm (in)	Wire Feed Speed m/min (in/min)	Voltage (volts)	Approx. Current (amps)	Melt-Off Rate kg/hr (lb/hr)
<b>0.035 in (0.9 mm), DC+</b>					
Short Circuit Transfer 75% Ar/25% CO <sub>2</sub>	9-12 (3/8-1/2)	2.5 (100)	17	80	0.7 (1.6)
		3.8 (150)	18	120	1.1 (2.4)
		6.4 (250)	22	175	1.8 (4.0)
Spray Transfer 90% Ar/10% CO <sub>2</sub>	12-19 (1/2-3/4)	9.5 (375)	23	195	2.7 (6.0)
		12.7 (500)	29	230	3.6 (8.0)
		15.2 (600)	30	275	4.4 (9.6)

<sup>(1)</sup>Typical all weld metal. <sup>(2)</sup>Measured with 0.2% offset. <sup>(3)</sup>See test results disclaimer <sup>(4)</sup>Copper due to any coating on the electrode plus the copper content of the filler metal itself, shall not exceed the stated 0.50% max.

<sup>(5)</sup>CTWD (Contact Tip to Work Distance). Subtract 1/4 in (6.4 mm) to calculate Electrical Stickout.

NOTE: For 100% CO<sub>2</sub> procedures, add 1 to 2 volts for short circuit transfer and 2 to 3 volts for globular transfer.

# BLUE MAX<sup>®</sup> MIG 308L N

Stainless Steel ▪ AWS ER308/ER308L

## KEY FEATURES

- Q2 Lot<sup>®</sup> - Certificate showing actual wire composition and calculated ferrite number (FN) available online
- Available as Batch Managed Inventory
- "N" Designator - cobalt restriction of 0.05% max
- Meets the low Si levels typically required in the nuclear industry
- Meets the low cobalt levels typically required in the nuclear industry.
- Prior to using this material for ASME Boiler and Pressure Vessel Code Section III applications, please contact the Lincoln Electric Specials Department to receive a Certified Material Test Report (CMTR) which meets all requirements of NCA-3860
- Composition controlled to meet nuclear and power generation requirements
- Each spool is identified with AWS classification and LOT number

## CONFORMANCES

**AWS A5.9:** ER308, ER308L

**ASME SFA-A5.9:** ER308, ER308L

## TYPICAL APPLICATIONS

- Nuclear power plant components, maintenance and construction
- Power and process industry related piping
- Pressure Vessels

## ASME IX QUALIFICATION

ASME IX Qualification: QW432 F-No 6,  
QW442 A-No 8

## WELDING POSITIONS

All

## DIAMETERS / PACKAGING

Diameter in (mm)	33 lb (15 kg) Steel Spool
0.035 (0.9)	ED033848
0.045 (1.1)	ED033849

## MECHANICAL PROPERTIES<sup>(1)</sup> – As Required per AWS A5.9

	Yield Strength <sup>(2)</sup> MPa (ksi)	Tensile Strength MPa (ksi)	Elongation %	Ferrite Number
<b>Requirements</b> - AWS ER308/308L			Not Specified	
<b>Typical Results</b> <sup>(3)</sup> - As-Welded	430 (62)	615 (89)	37	13

**WIRE COMPOSITION – As Required per AWS A5.9**

	%C	%Cr	%Ni	%Mo	%Mn
<b>Requirements</b> - AWS ER308L	0.03 <sup>(2)</sup> max	19.5 - 22.0	9.0 - 11.0	0.75 max	1.0 - 2.5
<b>Typical Results</b> <sup>(3)</sup>	0.02	20.2	9.2	0.03	1.6
	%Si	%P	%S	%Cu	Total Others
<b>Requirements</b> - AWS ER308L	0.30 - 0.65	0.03 max	0.03 max	0.75 max	0.50 max
<b>Typical Results</b> <sup>(3)</sup>	0.44	0.02	0.02	0.11	0.03

**TYPICAL OPERATING PROCEDURES**

Diameter, Polarity Shielding Gas	CTWD <sup>(4)</sup> mm (in)	Wire Feed Speed m/min (in/min)	Voltage (Volts)	Approx. Current (Amps)	Deposition Rate kg/hr (lb/hr)
<b>Short Circuit Transfer</b>					
<b>0.035 in (0.9 mm), DC+</b> 90% He / 7-1/2% Ar / 2-1/2% CO <sub>2</sub>	13 (1/2)	3.0 (120)	19-20	55	0.9 (2.0)
	13 (1/2)	4.6 (180)	19-20	85	1.4 (3.0)
	13 (1/2)	5.8 (230)	20-21	105	1.8 (3.9)
	13 (1/2)	7.6 (300)	20-21	125	2.3 (5.0)
	13 (1/2)	8.9 (350)	21-22	140	2.7 (5.9)
	13 (1/2)	10.2 (400)	22-23	160	3.1 (6.7)
<b>0.045 in (1.1 mm), DC+</b> 90% He / 7-1/2% Ar / 2-1/2% CO <sub>2</sub>	13 (1/2)	2.5 (100)	19-20	100	1.1 (2.8)
	13 (1/2)	3.2 (125)	19-20	120	1.5 (3.5)
	13 (1/2)	3.8 (150)	21	135	1.7 (4.2)
	13 (1/2)	4.4 (175)	21	140	2.0 (4.8)
	13 (1/2)	5.6 (220)	22	170	2.6 (6.1)
	13 (1/2)	6.4 (250)	22-23	175	2.9 (6.9)
13 (1/2)	7.0 (275)	22-23	185	3.2 (7.6)	
<b>Axial Spray Transfer</b>					
<b>0.035 in (0.9 mm), DC+</b> 98% Ar/2% O <sub>2</sub>	13 (1/2)	10.2 (400)	22	180	3.1 (6.7)
	13 (1/2)	10.8 (425)	23	190	3.3 (7.1)
	13 (1/2)	11.4 (450)	23	200	3.5 (7.5)
	13 (1/2)	12.1 (475)	23	210	3.7 (8.0)
<b>0.045 in (1.1 mm), DC+</b> 98% Ar/2% O <sub>2</sub>	13 (1/2)	6.1 (240)	23	195	2.8 (6.6)
	13 (1/2)	6.6 (260)	24	230	3.0 (7.2)
	13 (1/2)	7.6 (300)	24	240	3.5 (8.3)
	13 (1/2)	8.3 (325)	25	250	3.8 (9.0)
	13 (1/2)	9.1 (360)	25	260	4.2 (10.0)

<sup>(1)</sup>Typical all weld metal. <sup>(2)</sup>Measured with 0.2% offset. <sup>(3)</sup>See test results disclaimer <sup>(4)</sup>CTWD (Contact Tip to Work Distance). Subtract 1/4 in (6.4 mm) to calculate Electrical Stickout.  
NOTE: For 100% CO<sub>2</sub> procedures, add 1 to 2 volts for short circuit transfer and 2 to 3 volts for globular transfer.

IMPORTANT: SPECIAL VENTILATION AND/OR EXHAUST REQUIRED

Fumes from the normal use of some welding products can contain significant quantities of components - such as chromium and manganese - which can lower the 5.0 mg/m<sup>3</sup> maximum exposure guideline for general welding fume.

BEFORE USE, READ AND UNDERSTAND THE SAFETY DATA SHEET (SDS) FOR THIS PRODUCT AND SPECIFIC INFORMATION PRINTED ON THE PRODUCT CONTAINER.

# BLUE MAX<sup>®</sup> MIG 309L N

Stainless Steel ▪ AWS ER309/ER309L

## KEY FEATURES

- Q2 Lot<sup>®</sup> - Certificate showing actual wire composition and calculated ferrite number (FN) available online
- Available as Batch Managed Inventory
- "N" Designator - cobalt restriction of 0.05% max
- Meets the low Si levels typically required in the nuclear industry
- Meets the low cobalt levels typically required in the nuclear industry.
- Prior to using this material for ASME Boiler and Pressure Vessel Code Section III applications, please contact the Lincoln Electric Specials Department to receive a Certified Material Test Report (CMTR) which meets all requirements of NCA-3860
- Capable of meeting drop weight testing requirements as commonly required for nuclear applications
- Composition controlled to meet nuclear and power generation requirements
- Each spool is identified with AWS classification and LOT number

## CONFORMANCES

**AWS A5.9:** ER309, ER309L  
**ASME SFA-A5.9:** ER309, ER309L

## TYPICAL APPLICATIONS

- Nuclear power plant components, maintenance and construction
- Power and process industry related piping
- Pressure Vessels

## ASME IX QUALIFICATION

ASME IX Qualification: QW432 F-No 6,  
QW442 A-No 8

## WELDING POSITIONS

All

## DIAMETERS / PACKAGING

Diameter in (mm)	33 lb (15 kg) Steel Spool
0.035 (0.9)	ED033850
0.045 (1.1)	ED033851

## MECHANICAL PROPERTIES<sup>(1)</sup> – As Required per AWS A5.9

	Yield Strength <sup>(2)</sup> MPa (ksi)	Tensile Strength MPa (ksi)	Elongation %	Ferrite Number
<b>Requirements</b> - AWS ER309Si, ER309LSi	Not Specified			
<b>Typical Results<sup>(3)</sup></b> - As-Welded	450 (65)	595 (86)	35	14

**WIRE COMPOSITION – As Required per AWS A5.9**

	%C	%Cr	%Ni	%Mo	%Mn
<b>Requirements - AWS ER309L</b>	0.03 <sup>(2)</sup> max	23.0 - 25.0	12.0 - 14.0	0.75 max	1.0 - 2.5
<b>Typical Results<sup>(3)</sup></b>	0.02	23.7	13.9	0.04	1.8
	%Si	%P	%S	%Cu	Total Others
<b>Requirements - AWS ER309L</b>	0.30 - 0.65	0.03 max	0.03 max	0.75 max	0.50 max
<b>Typical Results<sup>(3)</sup></b>	0.51	0.02	0.01	0.05	0.06

**TYPICAL OPERATING PROCEDURES**

Diameter, Polarity Shielding Gas	CTWD <sup>(4)</sup> mm (in)	Wire Feed Speed m/min (in/min)	Voltage (Volts)	Approx. Current (Amps)	Deposition Rate kg/hr (lb/hr)
<b>Short Circuit Transfer</b>					
<b>0.035 in (0.9 mm), DC+</b> 90% He / 7-1/2% Ar / 2-1/2% CO <sub>2</sub>	13 (1/2)	3.0 (120)	19-20	55	0.9 (2.0)
	13 (1/2)	4.6 (180)	19-20	85	1.4 (3.0)
	13 (1/2)	5.8 (230)	20-21	105	1.8 (3.9)
	13 (1/2)	7.6 (300)	20-21	125	2.3 (5.0)
	13 (1/2)	8.9 (350)	21-22	140	2.7 (5.9)
	13 (1/2)	10.2 (400)	22-23	160	3.1 (6.7)
<b>0.045 in (1.1 mm), DC+</b> 90% He / 7-1/2% Ar / 2-1/2% CO <sub>2</sub>	13 (1/2)	2.5 (100)	19-20	100	1.1 (2.8)
	13 (1/2)	3.2 (125)	19-20	120	1.5 (3.5)
	13 (1/2)	3.8 (150)	21	135	1.7 (4.2)
	13 (1/2)	4.4 (175)	21	140	2.0 (4.8)
	13 (1/2)	5.6 (220)	22	170	2.6 (6.1)
	13 (1/2)	6.4 (250)	22-23	175	2.9 (6.9)
13 (1/2)	7.0 (275)	22-23	185	3.2 (7.6)	
<b>Axial Spray Transfer</b>					
<b>0.035 in (0.9 mm), DC+</b> 98% Ar/2% O <sub>2</sub>	13 (1/2)	10.2 (400)	22	180	3.1 (6.7)
	13 (1/2)	10.8 (425)	23	190	3.3 (7.1)
	13 (1/2)	11.4 (450)	23	200	3.5 (7.5)
	13 (1/2)	12.1 (475)	23	210	3.7 (8.0)
<b>0.045 in (1.1 mm), DC+</b> 98% Ar/2% O <sub>2</sub>	13 (1/2)	6.1 (240)	23	195	2.8 (6.6)
	13 (1/2)	6.6 (260)	24	230	3.0 (7.2)
	13 (1/2)	7.6 (300)	24	240	3.5 (8.3)
	13 (1/2)	8.3 (325)	25	250	3.8 (9.0)
	13 (1/2)	9.1 (360)	25	260	4.2 (10.0)

<sup>(1)</sup>Typical all weld metal. <sup>(2)</sup>Measured with 0.2% offset. <sup>(3)</sup>See test results disclaimer <sup>(4)</sup>CTWD (Contact Tip to Work Distance). Subtract 1/4 in (6.4 mm) to calculate Electrical Stickout.  
NOTE: For 100% CO<sub>2</sub> procedures, add 1 to 2 volts for short circuit transfer and 2 to 3 volts for globular transfer.

IMPORTANT: SPECIAL VENTILATION AND/OR EXHAUST REQUIRED

Fumes from the normal use of some welding products can contain significant quantities of components - such as chromium and manganese - which can lower the 5.0 mg/m<sup>3</sup> maximum exposure guideline for general welding fume.

BEFORE USE, READ AND UNDERSTAND THE SAFETY DATA SHEET (SDS) FOR THIS PRODUCT AND SPECIFIC INFORMATION PRINTED ON THE PRODUCT CONTAINER.



# BLUE MAX<sup>®</sup> MIG 316L N

Stainless Steel ▪ AWS ER316/ER316L

## KEY FEATURES

- Q2 Lot<sup>®</sup> - Certificate showing actual wire composition and calculated ferrite number (FN) available online
- Available as Batch Managed Inventory
- "N" Designator - cobalt restriction of 0.05% max
- Meets the low Si levels typically required in the nuclear industry
- Meets the low cobalt levels typically required in the nuclear industry.
- Prior to using this material for ASME Boiler and Pressure Vessel Code Section III applications, please contact the Lincoln Electric Specials Department to receive a Certified Material Test Report (CMTR) which meets all requirements of NCA-3860
- Composition controlled to meet nuclear and power generation requirements
- Each spool is identified with AWS classification and LOT number

## CONFORMANCES

**AWS A5.9:** ER316, ER316L

**ASME SFA-A5.9:** ER316, ER316L

## TYPICAL APPLICATIONS

- Nuclear power plant components, maintenance and construction
- Power and process industry related piping
- Pressure Vessels

## ASME IX QUALIFICATION

ASME IX Qualification: QW432 F-No 6, QW442 A-No 8

## WELDING POSITIONS

All

## DIAMETERS / PACKAGING

Diameter in (mm)	33 lb (15 kg) Steel Spool
0.035 (0.9)	ED033852
0.045 (1.1)	ED033853

## MECHANICAL PROPERTIES<sup>(1)</sup> – As Required per AWS A5.9

	Yield Strength <sup>(2)</sup> MPa (ksi)	Tensile Strength MPa (ksi)	Elongation %	Ferrite Number
<b>Requirements</b> - AWS ER316Si, ER316LSi	Not Specified			
<b>Typical Results<sup>(3)</sup></b> - As-Welded	405 (59)	560 (81)	40	10

**WIRE COMPOSITION – As Required per AWS A5.9**

	%C	%Cr	%Ni	%Mo	%Mn
<b>Requirements</b> - AWS ER316L	0.03 <sup>(2)</sup> max	18.0 - 20.0	11.0 - 14.0	2.0 - 3.0	1.0 - 2.5
<b>Typical Results</b> <sup>(3)</sup>	0.02	18.7	11.8	2.3	1.7
	%Si	%P	%S	%Cu	Total Others
<b>Requirements</b> - AWS ER316L	0.30 - 0.65	0.03 max	0.03 max	0.75 max	0.50 max
<b>Typical Results</b> <sup>(3)</sup>	0.52	0.02	0.01	0.10	0.30

**TYPICAL OPERATING PROCEDURES**

Diameter, Polarity Shielding Gas	CTWD <sup>(4)</sup> mm (in)	Wire Feed Speed m/min (in/min)	Voltage (Volts)	Approx. Current (Amps)	Deposition Rate kg/hr (lb/hr)
<b>Short Circuit Transfer</b>					
<b>0.035 in (0.9 mm), DC+</b> 90% He / 7-1/2% Ar / 2-1/2% CO <sub>2</sub>	13 (1/2)	3.0 (120)	19-20	55	0.9 (2.0)
	13 (1/2)	4.6 (180)	19-20	85	1.4 (3.0)
	13 (1/2)	5.8 (230)	20-21	105	1.8 (3.9)
	13 (1/2)	7.6 (300)	20-21	125	2.3 (5.0)
	13 (1/2)	8.9 (350)	21-22	140	2.7 (5.9)
	13 (1/2)	10.2 (400)	22-23	160	3.1 (6.7)
<b>0.045 in (1.1 mm), DC+</b> 90% He / 7-1/2% Ar / 2-1/2% CO <sub>2</sub>	13 (1/2)	2.5 (100)	19-20	100	1.1 (2.8)
	13 (1/2)	3.2 (125)	19-20	120	1.5 (3.5)
	13 (1/2)	3.8 (150)	21	135	1.7 (4.2)
	13 (1/2)	4.4 (175)	21	140	2.0 (4.8)
	13 (1/2)	5.6 (220)	22	170	2.6 (6.1)
	13 (1/2)	6.4 (250)	22-23	175	2.9 (6.9)
13 (1/2)	7.0 (275)	22-23	185	3.2 (7.6)	
<b>Axial Spray Transfer</b>					
<b>0.035 in (0.9 mm), DC+</b> 98% Ar/2% O <sub>2</sub>	13 (1/2)	10.2 (400)	22	180	3.1 (6.7)
	13 (1/2)	10.8 (425)	23	190	3.3 (7.1)
	13 (1/2)	11.4 (450)	23	200	3.5 (7.5)
	13 (1/2)	12.1 (475)	23	210	3.7 (8.0)
<b>0.045 in (1.1 mm), DC+</b> 98% Ar/2% O <sub>2</sub>	13 (1/2)	6.1 (240)	23	195	2.8 (6.6)
	13 (1/2)	6.6 (260)	24	230	3.0 (7.2)
	13 (1/2)	7.6 (300)	24	240	3.5 (8.3)
	13 (1/2)	8.3 (325)	25	250	3.8 (9.0)
	13 (1/2)	9.1 (360)	25	260	4.2 (10.0)

<sup>(1)</sup>Typical all weld metal. <sup>(2)</sup>Measured with 0.2% offset. <sup>(3)</sup>See test results disclaimer. <sup>(4)</sup>CTWD (Contact Tip to Work Distance). Subtract 1/4 in (6.4 mm) to calculate Electrical Stickout.  
NOTE: For 100% CO<sub>2</sub> procedures, add 1 to 2 volts for short circuit transfer and 2 to 3 volts for globular transfer.

IMPORTANT: SPECIAL VENTILATION AND/OR EXHAUST REQUIRED

Fumes from the normal use of some welding products can contain significant quantities of components - such as chromium and manganese - which can lower the 5.0 mg/m<sup>3</sup> maximum exposure guideline for general welding fume.

BEFORE USE, READ AND UNDERSTAND THE SAFETY DATA SHEET (SDS) FOR THIS PRODUCT AND SPECIFIC INFORMATION PRINTED ON THE PRODUCT CONTAINER.

# BLUE MAX® LNM 4462 N

Stainless Steel ▪ AWS ER2209

## KEY FEATURES

- Q2 Lot® - Certificate showing actual wire composition and calculated ferrite number (FN) available online
- Available as Batch Managed Inventory
- "N" Designator - cobalt restriction of 0.05% max
- Premium performance and quality
- Designed for joining duplex stainless steels
- Provides high resistance to general corrosion, pitting and stress corrosion
- Composition is controlled to produce consistent mechanical properties
- Prior to using this material for ASME Boiler and Pressure Vessel Code Section III applications, please contact the Lincoln Electric Specials Department to receive a Certified Material Test Report (CMTR) which meet all requirements of NCA-3860

## CONFORMANCES

**AWS A5.9-93:** ER2209  
**ASME SFA-A5.9:** ER2209

## TYPICAL APPLICATIONS

- Nuclear power plant construction and maintenance
- Alloy 2205: UNS S31803, UNS S31500
- Alloy 2304: UNS S32304, UNS S31200
- Air pollution control systems for coal fired power plants
- Power and process industry components and piping
- Pressure Vessels

## ASME IX QUALIFICATION

ASME IX Qualification: QW432 F-No 6,  
 QW442 A-No 8

## WELDING POSITIONS

All

## DIAMETERS / PACKAGING

Diameter in (mm)	33 lb (15 kg) Plastic Spool
0.035 (0.9)	ED033955
0.045 (1.2)	ED033956

## MECHANICAL PROPERTIES<sup>(1)</sup> – As Required per AWS A5.9

	Yield Strength <sup>(2)</sup> MPa (ksi)	Tensile Strength MPa (ksi)	Elongation %	Charpy V-Notch J (ft-lbf) @ -40° C (-40° F)
<b>Requirements</b> - AWS ER2209	Not Specified			
<b>Typical Results<sup>(3)</sup></b> As-Welded with 98% Ar / 2% CO <sub>2</sub>	625 (91)	810 (118)	28	105 (78)

## WIRE COMPOSITION<sup>(1)</sup> – As Required per AWS A5.9

	%C	%Cr	%Ni	%Mo	%Mn
<b>Requirements</b> - AWS ER2209	0.030 max	21.5-23.5	7.5-9.5	2.5-3.5	0.5-2.0
<b>Typical Results<sup>(3)</sup></b>	0.018	22.7	8.5	3.0	1.5
	%Si	%P	%S	%Cu	%N
<b>Requirements</b> - AWS ER2209	0.90 max	0.03 max	0.03 max	0.75 max	0.08-0.20
<b>Typical Results<sup>(3)</sup></b>	0.45	0.03	0.03	0.30	0.15

<sup>(1)</sup>Typical all weld metal. <sup>(2)</sup>Measured with 0.2% offset. <sup>(3)</sup>See test results disclaimer.

IMPORTANT: SPECIAL VENTILATION AND/OR EXHAUST REQUIRED

Fumes from the normal use of some welding products can contain significant quantities of components - such as chromium and manganese - which can lower the 5.0 mg/m<sup>3</sup> maximum exposure guideline for general welding fume.

BEFORE USE, READ AND UNDERSTAND THE SAFETY DATA SHEET (SDS) FOR THIS PRODUCT AND SPECIFIC INFORMATION PRINTED ON THE PRODUCT CONTAINER.

# LINCOLN® ER100S-1

Mild Steel ▪ AWS ER100S-1

## KEY FEATURES

- A low carbon, high manganese wire with nickel and molybdenum designed to weld high strength steels such as HY-80 and HSLA-80
- Delivers yield strength greater than 690 MPa (100 ksi)
- Capable of producing welds with 690 MPa (100 ksi) tensile strength
- Prior to using this material for ASME Boiler and Pressure Vessel Code Section III applications, please contact the Lincoln Electric Specials Department to receive a Certified Material Test Report (CMTR) which meets all requirements of NCA-3860
- Product is marked every 4 in. (101.6 mm) with AWS classification and LOT number for easy identification

## WELDING POSITIONS

All

## CONFORMANCES

<b>AWS A5.28:</b>	ER100S-1, ER110S-1
<b>ASME SFA-A5.28:</b>	ER100S-1, ER110S-1
<b>MIL-E-23765/2:</b>	MIL-100S-1

## TYPICAL APPLICATIONS

- HY-80 base material
- ASTM A514, A543, A724 and A782 quenched and tempered plate
- Various heat input conditions
- Military low alloy applications
- Nuclear Steam Generators and other components

## ASME IX QUALIFICATION

ASME IX Qualification:	QW432 F-No 6
	QW432 A-No 10

## DIAMETERS / PACKAGING

Diameter in (mm)	10 lb (4.5 kg) Carton
3/32 (2.4)	ED034097
1/8 (3.2)	ED034098

## WIRE COMPOSITION - As Required per AWS A5.28

	%C	%Mn	%Si	%Ni	%Mo
<b>Requirements</b> - AWS ER100S-1	0.08 max	1.25-1.80	0.20-0.55	1.40-2.10	0.25-0.55
<b>Typical Results</b> <sup>(1)</sup>	0.05-0.06	1.63-1.69	0.46-0.50	1.88-1.96	0.43-0.45
	%Cr	%S	%P	%V	%Al
<b>Requirements</b> - AWS ER100S-1	0.30 max	0.010 max	0.010 max	0.05 max	0.10 max
<b>Typical Results</b> <sup>(1)</sup>	0.04-0.06	0.002-0.005	0.005-0.009	≤ 0.01	≤ 0.01
	%Ti	%Zr	%Cu	Total Others	
<b>Requirements</b> - AWS ER100S-1	0.10 max	0.10 max	0.25 max	0.50 max	
<b>Typical Results</b> <sup>(1)</sup>	0.03-0.04	≤ 0.01	0.11-0.14	-	

<sup>(1)</sup>See test results disclaimer

IMPORTANT: SPECIAL VENTILATION AND/OR EXHAUST REQUIRED

Fumes from the normal use of some welding products can contain significant quantities of components - such as chromium and manganese - which can lower the 5.0 mg/m<sup>3</sup> maximum exposure guideline for general welding fume.

BEFORE USE, READ AND UNDERSTAND THE SAFETY DATA SHEET (SDS) FOR THIS PRODUCT AND SPECIFIC INFORMATION PRINTED ON THE PRODUCT CONTAINER.

# LINCOLN® ER308/308L N

Stainless Steel ▪ AWS ER308/ER308L

## KEY FEATURES

- Q2 Lot® - Certificate showing actual wire composition and calculated ferrite number (FN) available online
- "N" Designator - cobalt restriction of 0.05% max
- Available as Batch Managed Inventory
- Use on base metals of similar composition
- Meets the low cobalt levels typically required in the nuclear industry
- Dual classification ensures the maximum carbon content is 0.03%
- 0.03% carbon content increases resistance to intergranular corrosion
- Prior to using this material for ASME Boiler and Pressure Vessel Code Section III applications, please contact the Lincoln Electric Specials Department to receive a Certified Material Test Report (CMTR) which meets all requirements of NCA-3860
- Product is marked every 4 in. (101.6 mm) with AWS classification and LOT number for easy identification

## CONFORMANCES

**AWS A5.9:** ER308, ER308L  
**ASME SFA-A5.9:** ER308, ER308L

## TYPICAL APPLICATIONS

- Nuclear power plant components, maintenance and construction
- Sheet metal on the corresponding stainless steel base metals
- High pressure piping and tubing
- Pressure Vessels

## ASME IX QUALIFICATION

ASME IX Qualification: QW432 F-No 6, QW442 A-No 8

## WELDING POSITIONS

All

## DIAMETERS / PACKAGING

Diameter in (mm)	10 lb (4.5 kg) Plastic Tube 30 lb (13.6 kg) Master
3/32 (2.4)	ED033854
1/8 (3.2)	ED033855

## WIRE COMPOSITION – As Required per AWS A5.9

	%C <sup>(2)</sup>	%Cr	%Ni	%Mo	%Mn
<b>Requirements - AWS ER308L</b>	0.03max	19.5 - 22.0	9.0 - 11.0	0.75 max	1.0 - 2.5
<b>Typical Results<sup>(1)</sup></b>	0.02	20.2	9.2	0.03	1.6
	%Si	%P	%S	%Cu	Total Others
<b>Requirements - AWS ER308L</b>	0.30 - 0.65	0.03 max	0.03 max	0.75 max	0.50 max
<b>Typical Results<sup>(1)</sup></b>	0.44	0.02	0.02	0.11	0.03

<sup>(1)</sup>See test results disclaimer <sup>(2)</sup>Requirements for ER308 is 0.08% max. carbon.

IMPORTANT: SPECIAL VENTILATION AND/OR EXHAUST REQUIRED

Fumes from the normal use of some welding products can contain significant quantities of components - such as chromium and manganese - which can lower the 5.0 mg/m<sup>3</sup> maximum exposure guideline for general welding fume.

BEFORE USE, READ AND UNDERSTAND THE SAFETY DATA SHEET (SDS) FOR THIS PRODUCT AND SPECIFIC INFORMATION PRINTED ON THE PRODUCT CONTAINER.

# LINCOLN® ER309/309L N

Stainless Steel ▪ AWS ER309/ER309L

## KEY FEATURES

- Q2 Lot® - Certificate showing actual wire composition and calculated ferrite number (FN) available online
- Available as Batch Managed Inventory
- "N" Designator - cobalt restriction of 0.05% max
- Use for welding dissimilar alloys in wrought or cast form
- Meets the low cobalt levels typically required in the nuclear industry
- Occasionally used for welding "18-8" base metals when severe corrosion conditions exist or dissimilar metals
- 0.03% carbon content increases resistance to intergranular corrosion
- Prior to using this material for ASME Boiler and Pressure Vessel Code Section III applications, please contact the Lincoln Electric Specials Department to receive a Certified Material Test Report (CMTR) which meets all requirements of NCA-3860
- Product is marked every 4 in. (101.6 mm) with AWS classification and LOT number for easy identification

## CONFORMANCES

**AWS A5.9:** ER309, ER309L  
**ASME SFA-A5.9:** ER309, ER309L

## TYPICAL APPLICATIONS

- Nuclear power plant components, maintenance and construction
- Sheet metal on the corresponding stainless steel base metals
- High pressure piping and tubing
- Pressure Vessels

## ASME IX QUALIFICATION

ASME IX Qualification: QW432 F-No 6, QW442 A-No 8

## WELDING POSITIONS

All

## DIAMETERS / PACKAGING

Diameter in (mm)	10 lb (4.5 kg) Plastic Tube 30 lb (13.6 kg) Master
3/32 (2.4)	ED033856
1/8 (3.2)	ED033857

## WIRE COMPOSITION – As Required per AWS A5.9

	%C <sup>(2)</sup>	%Cr	%Ni	%Mo	%Mn
<b>Requirements</b> - AWS ER309L	0.03 max	23.0 - 25.0	12.0 - 14.0	0.75 max	1.0 - 2.5
<b>Typical Results</b> <sup>(1)</sup>	0.02	23.7	13.9	0.04	1.8
	%Si	%P	%S	%Cu	Total Others
<b>Requirements</b> - AWS ER309L	0.30 - 0.65	0.03 max	0.03 max	0.75 max	0.50 max
<b>Typical Results</b> <sup>(1)</sup>	0.51	0.02	0.01	0.05	0.06

<sup>(1)</sup>See test results disclaimer <sup>(2)</sup>Requirements for ER309 is 0.12% max. carbon.

IMPORTANT: SPECIAL VENTILATION AND/OR EXHAUST REQUIRED

Fumes from the normal use of some welding products can contain significant quantities of components - such as chromium and manganese - which can lower the 5.0 mg/m<sup>3</sup> maximum exposure guideline for general welding fume.

BEFORE USE, READ AND UNDERSTAND THE SAFETY DATA SHEET (SDS) FOR THIS PRODUCT AND SPECIFIC INFORMATION PRINTED ON THE PRODUCT CONTAINER.

# BLUE MAX<sup>®</sup> LNT 4462 N

Stainless Steel ▪ AWS ER2209

## KEY FEATURES

- Q2 Lot<sup>®</sup> - Certificate showing actual wire composition and calculated ferrite number (FN) available online
- Available as Batch Managed Inventory
- "N" Designator - cobalt restriction of 0.05% max
- Premium performance and quality
- Designed for joining duplex stainless steels, such as type 2205, for applications with service temperatures up to 250°C (480°F) and down to -40°C (-40°F).
- Provides high resistance to general corrosion, pitting and stress corrosion
- Composition is controlled to produce consistent mechanical properties

## CONFORMANCES

**AWS A5.9:** ER2209  
**ASME SFA-A5.9:** ER2209

## TYPICAL APPLICATIONS

- Nuclear power plant construction and maintenance
- Alloy 2205: UNS S31803, UNS S31500
- Alloy 2304: UNS S32304, UNS S31200
- Air pollution control systems for coal fired power plants
- Power and process industry components and piping
- Pressure Vessels

## WELDING POSITIONS

All

## ASME IX QUALIFICATION

ASME IX Qualification: QW432 F-No 6,  
 QW442 A-No 8

## DIAMETERS / PACKAGING

Diameter in (mm)	10 lb (4.5 kg) Plastic Tube 30 lb (13.6 kg) Master
3/32 (2.4)	ED033957
1/8 (3.2)	ED033958

## MECHANICAL PROPERTIES<sup>(1)</sup> – As Required per AWS A5.9

	Yield Strength <sup>(2)</sup> MPa (ksi)	Tensile Strength MPa (ksi)	Elongation %	Charpy V-Notch J (ft·lbf)	
				@ -20°C (-4°F)	@ -60°C (-75°F)
<b>Requirements</b> - AWS ER2209			Not Specified		
<b>Typical Results<sup>(3)</sup></b> - As-Welded	600 (87)	800 (116)	28	60 (44)	45 (33)

## WIRE COMPOSITION<sup>(1)</sup> – As Required per AWS A5.9

	%C	%Cr	%Ni	%Mo	%Mn
<b>Requirements</b> - AWS ER2209	0.030 max	21.5-23.5	7.5-9.5	2.5-3.5	0.5-2.0
<b>Typical Results<sup>(3)</sup></b>	0.018	22.7	8.5	3.0	1.5
	%Si	%P	%S	%Cu	%N
<b>Requirements</b> - AWS ER2209	0.90 max	0.03 max	0.03 max	0.75 max	0.08-0.20
<b>Typical Results<sup>(3)</sup></b>	0.50	0.03	0.03	0.30	0.15

<sup>(1)</sup>Typical all weld metal. <sup>(2)</sup>Measured with 0.2% offset. <sup>(3)</sup>See test results disclaimer

IMPORTANT: SPECIAL VENTILATION AND/OR EXHAUST REQUIRED

Fumes from the normal use of some welding products can contain significant quantities of components - such as chromium and manganese - which can lower the 5.0 mg/m<sup>3</sup> maximum exposure guideline for general welding fume.

BEFORE USE, READ AND UNDERSTAND THE SAFETY DATA SHEET (SDS) FOR THIS PRODUCT AND SPECIFIC INFORMATION PRINTED ON THE PRODUCT CONTAINER.

# SUPERARC® ORBITAL TIG L-52 N

Mild Steel ▪ AWS ER70S-2

## KEY FEATURES

- Ultra-clean surface treatment for porosity free welds
- Q2 Lot® - Certificate showing actual wire composition available online
- Available as Batch Managed Inventory
- "N" Designator - design modified to meet properties after stress relief
- A PLW product which has been treated to minimize weld defects that can be seen in the use of MIG wires for the automatic TIG process
- Provides a consistent and exceptionally stable arc for automatic TIG welding
- Contains zirconium, titanium, and aluminum in addition to silicon and manganese
- Produces x-ray quality welds over most surface conditions
- Recommended for TIG welding on all grades of steel
- Excellent choice for PWHT applications
- Each spool is identified with AWS classification and LOT number

## CONFORMANCES

AWS A5: ER70S-2

## TYPICAL APPLICATIONS

- Nuclear power plant construction and maintenance
- Power and process industry related piping
- Medium to heavy mill scale base material
- Robotic or hard automation

## ASME IX QUALIFICATION

ASME IX Qualification: QW432 F-No 6, QW442 A-No 1

## WELDING POSITIONS

All

## DIAMETERS / PACKAGING

Diameter in (mm)	2 lb (1 kg) Plastic Spool 8 lb (3.6 kg) Master Carton	10 lb (4.5 kg) Plastic Spool
0.035 (0.9)	ED033947	ED033948

## WIRE COMPOSITION<sup>(1)</sup> – As Required per AWS A5.18

	%C	%Mn	%S	%Si	%P	%Cu	%Cr
<b>Requirements</b> - AWS ER70S-2	0.07 max	0.90-1.40	0.035 max	0.40-0.70	0.0025 max	0.50 max	(1)
<b>Typical Results<sup>(2)</sup></b>	0.04	1.08	0.005	0.55	0.0003	0.20	0.08
	%Ni	%Mo	%V	%Al	%Ti	%Zr	
<b>Requirements</b> - AWS ER70S-2	(1)	(1)	(1)	0.05-0.15	0.05-0.15	0.02-0.12	
<b>Typical Results<sup>(2)</sup></b>	0.08	0.08	< 0.002	0.08	0.10	0.07	

<sup>(1)</sup>Typical all weld metal. <sup>(2)</sup>See test results disclaimer



# SUPERARC® ORBITAL TIG L-56® N

Mild Steel ▪ AWS ER70S-6

## KEY FEATURES

- Ultra-clean surface treatment for porosity free welds
- Q2 Lot® - Certificate showing actual wire composition available online
- Available as Batch Managed Inventory
- "N" Designator - design modified to meet properties after stress relief
- A PLW product which has been treated to minimize weld defects that can be seen in the use of MIG wires for the automatic TIG process.
- Provides a consistent and exceptionally stable arc for automatic TIG welding
- High levels of manganese and silicon deoxidizers tolerate medium to heavy mill scale surfaces
- Excellent toe-wetting provides optimal bead appearance
- Each spool is identified with AWS classification and LOT number

## CONFORMANCES

AWS A5: ER70S-6

## TYPICAL APPLICATIONS

- Nuclear power plant construction and maintenance
- Power and process industry related piping
- Medium to heavy mill scale base material
- Robotic or hard automation

## ASME IX QUALIFICATION

ASME IX Qualification: QW432 F-No 6, QW442 A-No 1

## WELDING POSITIONS

All

## DIAMETERS / PACKAGING

Diameter in (mm)	2 lb (1 kg) Plastic Spool 8 lb (3.6 kg) Master Carton	10 lb (4.5 kg) Plastic Spool
0.035 (0.9)	ED033840	ED033841

## WIRE COMPOSITION<sup>(1)</sup> – As Required per AWS A5.18

	%C	%Mn	%Si	%S	%P
<b>Requirements</b> - AWS ER70S-6	0.06-0.15	1.40-1.85	0.80-1.15	0.035 max	0.025 max
<b>Typical Results</b> <sup>(2)</sup>	0.08-0.09	1.42-1.60	0.81-0.87	0.006-0.010	0.004-0.010
	%Cr	%Ni	%Mo	%V	%Cu (Total) <sup>(3)</sup>
<b>Requirements</b> - AWS ER70S-6	0.15 max	0.15 max	0.15 max	0.03 max	0.50 max
<b>Typical Results</b> <sup>(2)</sup>	0.01-0.05	≤ 0.04	≤ 0.01	< 0.01	0.17-0.22

<sup>(1)</sup>Typical all weld metal. <sup>(2)</sup>See test results disclaimer <sup>(3)</sup>Copper due to any coating on the electrode plus the copper content of the filler metal itself, shall not exceed the stated 0.50% max. †

# BLUE MAX® ORBITAL TIG 308/308L N

Mild Steel ▪ AWS ER308, 308L

## KEY FEATURES

- Ultra-clean surface treatment for porosity free welds
- Q2 Lot® - Certificate showing actual wire composition and calculated ferrite number (FN) available online
- Batch Managed Inventory
- "N" Designate - design modified to meet special chemistry requirements
- 0.05% max Cobalt
- Prior to using this material for ASME Boiler and Pressure Vessel Code Section III applications, please contact Lincoln Electric Specials Department to receive a Certified Material Test Report (CMTR) which meet all requirements of NCA-3860

## CONFORMANCES

AWS A5: ER308L

## TYPICAL APPLICATIONS

- Nuclear Energy
- Thermal Energy
- Petroleum Processing
- Pressure Vessel
- Contractors
- Process Piping

## SHIELDING GAS

100% Argon

## WELDING POSITIONS

All

## DIAMETERS / PACKAGING

Diameter in (mm)	2 lb (1 kg) Spool 8 lb (3.6 kg) Carton	10 lb (4.5 kg) Spool
0.035 (0.9)	ED034141	ED034143

## WIRE COMPOSITION<sup>(1)</sup> – As Required per AWS A5.9

	%C	%Mn	%Si	%S	%P	%Cr
<b>Requirements</b> - AWS ER308/308L	0.03 max	1.0-2.5	0.30-0.65	0.03 max	0.03 max	19.5-22.0
<b>Typical Results<sup>(2)</sup></b>	0.02	1.20	0.39	<0.01	0.02	20.20
	%Ni	%Mo	%Cu	%N	%Co	FN
<b>Requirements</b> - AWS ER308/308L	9.0-11.0	0.75 max	0.75 max	Not Specified	0.05 max	Not Required
<b>Typical Results<sup>(2)</sup></b>	10.30	0.16	0.11	0.02	0.04	Not Required

<sup>(1)</sup>Typical all weld metal. <sup>(2)</sup>See test results disclaimer

# BLUE MAX® ORBITAL TIG 309/309L N

Mild Steel ▪ AWS ER309, 309L

## KEY FEATURES

- Ultra-clean surface treatment for porosity free welds
- Q2 Lot® - Certificate showing actual wire composition and calculated ferrite number (FN) available online
- Batch Managed Inventory
- "N" Designate - design modified to meet special chemistry requirements
- 0.05% max Cobalt
- Prior to using this material for ASME Boiler and Pressure Vessel Code Section III applications, please contact Lincoln Electric Specials Department to receive a Certified Material Test Report (CMTR) which meet all requirements of NCA-3860

## CONFORMANCES

AWS A5: ER309L

## TYPICAL APPLICATIONS

- Nuclear Energy
- Thermal Energy
- Petroleum Processing
- Process Piping

## SHIELDING GAS

100% Argon

## WELDING POSITIONS

All

## DIAMETERS / PACKAGING

Diameter in (mm)	2 lb (1 kg) Spool 8 lb (3.6 kg) Carton	10 lb (4.5 kg) Spool
0.035 (0.9)	ED034145	ED034147

## WIRE COMPOSITION<sup>(1)</sup> – As Required per AWS A5.9

	%C	%Mn	%Si	%S	%P	%Cr
<b>Requirements</b> - AWS ER308/308L	0.03 max	1.0-2.5	0.30-0.65	0.03 max	0.03 max	23.0-25.0
<b>Typical Results<sup>(2)</sup></b>	0.02	1.60	0.36	<0.01	0.02	23.80
	%Ni	%Mo	%Cu	%N	%Co	FN
<b>Requirements</b> - AWS ER308/308L	12.0-14.0	0.75 max	0.75 max	Not Specified	0.05 max	Not Required
<b>Typical Results<sup>(2)</sup></b>	13.30	0.12	0.10	0.08	0.04	Not Required

<sup>(1)</sup>Typical all weld metal. <sup>(2)</sup>See test results disclaimer

# BLUE MAX® ORBITAL TIG 316/316L N

Mild Steel ▪ AWS ER316, 316L

## KEY FEATURES

- Ultra-clean surface treatment for porosity free welds
- Q2 Lot® - Certificate showing actual wire composition and calculated ferrite number (FN) available online
- Batch Managed Inventory
- "N" Designate - design modified to meet special chemistry requirements
- 0.05% max Cobalt
- Prior to using this material for ASME Boiler and Pressure Vessel Code Section III applications, please contact Lincoln Electric Specials Department to receive a Certified Material Test Report (CMTR) which meet all requirements of NCA-3860

## WELDING POSITIONS

All

## CONFORMANCES

- AWS A5:** ER316, ER316L  
**ABS:** ER316, ER316L  
**ISO:** SS316L

## TYPICAL APPLICATIONS

- Nuclear Energy
- Thermal Energy
- Petroleum Processing
- Process Piping

## SHIELDING GAS

100% Argon

## DIAMETERS / PACKAGING

Diameter in (mm)	2 lb (1 kg) Spool 8 lb (3.6 kg) Carton	10 lb (4.5 kg) Spool
0.035 (0.9)	ED034149	ED034151

## WIRE COMPOSITION<sup>(1)</sup> – As Required per AWS A5.9

	%C	%Mn	%Si	%S	%P	%Cr
<b>Requirements</b> - AWS ER316/316L	0.03 max	1.0-2.5	0.30-0.65	0.03 max	0.03 max	18.0-20.0
<b>Typical Results<sup>(2)</sup></b>	0.02	1.70	0.36	<0.01	0.01	19.70
	%Ni	%Mo	%Cu	%N	%Co	FN
<b>Requirements</b> - AWS ER316/316L	11.0-14.0	2.0-3.0	0.75 max	Not Specified	0.05 max	Not Required
<b>Typical Results<sup>(2)</sup></b>	11.60	2.10	0.03	0.02	0.04	Not Required

<sup>(1)</sup>Typical all weld metal. <sup>(2)</sup>See test results disclaimer

# SUPERARC® ORBITAL TIG AK-10™

Low Alloy Steel ▪ AWS ER100S-G

## KEY FEATURES

- Ultra-clean surface treatment for porosity free welds
- Capable of producing welds with 690 MPa (100 ksi) tensile strength
- Suitable for use where consumables with less than 1% Ni are required
- Batch Managed Inventory
- Precision layer wound

## WELDING POSITIONS

All

## CONFORMANCES

AWS A5: ER100S-G

## TYPICAL APPLICATIONS

- NACE applications
- Oil tools
- Riser systems
- High-strength pipe

## TYPICAL BASE METALS

HY-80 or HY-100 per MIL-S-16216, A514 Grade B or P, AISI 4130 or 8620, API X-70 or X-80

## DIAMETERS / PACKAGING

Diameters in (mm)	10 lb (4.5kg) Plastic Spool	33 lb (15kg) Plastic Spool
0.035 (0.9)	ED035372	ED035373
0.045 (1.1)	ED035374	ED035375

## WIRE COMPOSITION<sup>(1)</sup> – As Required per AWS A5.28

	%C	%Mn	%Si	%Ni	%Mo	%Cr	%S	%P	%V	%Al	%Cu
Requirements - AWS ER100S-G	–	–	–	(A)	(A)	(A)	–	–	–	–	–
Typical Results <sup>(2)</sup>	0.10	1.55	0.57	0.88	0.47	0.28	< 0.005	0.01	< 0.003	0.003	0.12

(A) Must have the minimum of one or more of the following: 0.50% Ni, 0.30% Cr, or 0.20% Mo.

<sup>(1)</sup>Typical all weld metal. <sup>(2)</sup>See test results disclaimer

# SUPERARC® ORBITAL TIG ER80S-B2

Low Alloy Steel ▪ AWS ER80S-B2

## KEY FEATURES

- Ultra-clean surface treatment for porosity free welds
- Trace elements are controlled to ensure low Bruscato (X-Factor <10 ppm) for resistance to temper embrittlement
- Designed for welding 1.25% chromium, 0.50% Molybdenum steels
- Designed for prolonged elevated temperatures up to 550°C (1020°F)
- Capable of exceeding AWS minimum requirement of 550 MPa (80 ksi) tensile strength after 8 hours of stress relieving at 620°C (1150°F)
- Precision Layer Wound

## WELDING POSITIONS

All

## CONFORMANCES

AWS A5: ER80S-B2

## TYPICAL APPLICATIONS

- Petrochemical
- Power Generation
- Power Plants
- Process Piping
- Turbine Castings

## SHIELDING GAS

100% Argon

## DIAMETERS / PACKAGING

Diameters in (mm)	2 lb (1 kg) Plastic Spool 8 lb (3.6 kg) Master Carton	10 lb (4.5 kg) Plastic Spool
0.035 (0.9)	ED034465	ED034469
0.045 (1.1)	ED034466	ED034470

## WIRE COMPOSITION - As Required per AWS A5.28

	%C	%Mn	%Si	%Ni	%P	%S
Requirements - AWS ER80S-B2	0.07-0.12	0.40-0.70	0.40-0.70	0.20 max	0.025 max	0.025 max
Typical Results <sup>(1)</sup>	0.10-0.11	0.56-0.57	0.54-0.55	0.03-0.04	0.003-0.004	0.003
	%Cr	%Mo	%Cu	%Sb	%Sn	%As
Requirements - AWS ER80S-B2	1.20-1.50	0.40-0.65	0.35 max	N/A	N/A	N/A
Typical Results <sup>(1)</sup>	1.35-1.40	0.49-0.52	0.26-0.29	0.001	0.003-0.004	0.002

<sup>(1)</sup>See test results disclaimer

# SUPERARC® ORBITAL TIG ER90S-B3

Low Alloy Steel ▪ AWS ER90S-B3

## KEY FEATURES

- Ultra-clean surface treatment for porosity free welds
- Trace elements are controlled to ensure low Bruscato (X-Factor <10 ppm) for resistance to temper embrittlement
- Designed for prolonged elevated temperatures up to 600°C (1100°F)
- Designed for welding of 2.25% chromium, 1% molybdenum low alloy steels
- Capable of exceeding AWS minimum requirement of 620 MPa (90 ksi) tensile strength after 8 hours of stress relieving at 690°C (1275°F)
- Precision Layer Wound

## WELDING POSITIONS

All

## CONFORMANCES

**AWS A5.28:** ER90S-B3

**ASME SFA-5.28:** ER90S-B3

## TYPICAL APPLICATIONS

- Petrochemical
- Power Generation
- Power Plants
- Pressure Vessels
- Process Piping
- Turbine Castings

## SHIELDING GAS

100% Argon

## DIAMETERS / PACKAGING

Diameters in (mm)	2 lb (1 kg) Plastic Spool 8 lb (3.6 kg) Master Carton	10 lb (4.5 kg) Plastic Spool
0.035 (0.9)	ED034467	ED034471
0.045 (1.1)	ED034468	ED034472

## WIRE COMPOSITION - As Required per AWS A5.28

	%C	%Mn	%Si	%Ni	%P	%S
<b>Requirements</b> - AWS ER90S-B3	0.07-0.12	0.40-0.70	0.40-0.70	0.20 max	0.025 max	0.025 max
<b>Typical Results</b> <sup>(1)</sup>	0.09-0.10	0.53-0.57	0.53-0.57	0.03-0.04	0.004	0.003- 0.004
	%Cr	%Mo	%Cu	%Sb	%Sn	%As
<b>Requirements</b> - AWS ER90S-B3	2.30-2.70	0.90-1.20	0.35 max	N/A	N/A	N/A
<b>Typical Results</b> <sup>(1)</sup>	2.38-2.42	0.99-1.02	0.06	0.001	0.002-0.003	0.001

<sup>(1)</sup>See test results disclaimer

# LINCOLNWELD® MIL800-H™ & LA-84

Low Alloy Steel ■ AWS F9P6-EF3-F3-H2

## KEY FEATURES

- Capable of exceeding AWS minimum requirement of 620 Mpa (90 ksi) tensile strength after 48 hours of stress relieving at 1100-1150°F.
- Capable of meeting drop weight testing requirements as commonly required for nuclear applications.
- Each coil is identified with AWS classification and LOT number.

## TYPICAL APPLICATIONS

- Nuclear reactor vessels and other components

## ASME IX QUALIFICATION

ASME IX Qualification: QW432 F-No 6

## DIAMETERS / PACKAGING - FLUX

50 lb (22.7 kg)  
Hermetically Sealed Foil Bag

ED035892

## DIAMETERS / PACKAGING - WIRE

Diameter in (mm)	60 lb (27.2 kg) Coil
5/64 (2.0)	ED034211
3/32 (2.4)	ED031871
1/8 (3.2)	ED033323
5/32 (4.0)	ED034212

## WIRE COMPOSITION<sup>(1)</sup> - As Required per AWS A5.23

	%C	%Mn	%Si	%Ni	%Mo	%S	%P	%Cu
Lincolnweld® LA-84	0.10-0.18	1.75-2.20	0.2	0.80-1.0	0.45-0.60	0.010-0.020	0.010-0.020	0.05-0.15

## FLUX COMPOSITION<sup>(1)</sup>

	%SiO <sub>2</sub>	%MnO	%MgO	%CaF <sub>2</sub>	%Na <sub>2</sub> O	%Al <sub>2</sub> O <sub>3</sub>	%CaO	%K <sub>2</sub> O	% Metal Alloys
Lincolnweld® MIL800-H™	13	1	34	23	1	16	8	1	1 max

<sup>(1)</sup>Typical all weld metal.



# LINCOLNWELD® MIL800-H™ & LA-100

Low Alloy Steel ▪ AWS F10A6-EM2-M2-H2

## KEY FEATURES

- Capable of exceeding AWS minimum requirement of 620 Mpa (90 ksi) tensile strength after 48 hours of stress relieving at 1100-1150°F.
- Capable of meeting drop weight testing requirements as commonly required for nuclear applications.
- Each coil is identified with AWS classification and LOT number.

## TYPICAL APPLICATIONS

- Nuclear reactor vessels and other components

## ASME IX QUALIFICATION

ASME IX Qualification: QW432 F-No 6

## DIAMETERS / PACKAGING - FLUX

50 lb (22.7 kg)  
Hermetically Sealed Foil Bag

ED035892

## DIAMETERS / PACKAGING - WIRE

Diameter in (mm)	60 lb (27.2 kg) Coil
1/16 (1.6)	ED010996
5/64 (2.0)	ED011002
3/32 (2.4)	ED010999
1/8 (3.2)	ED010998
5/32 (4.0)	EDS11001

## WIRE COMPOSITION<sup>(1)</sup> - As Required per AWS A5.23

	%C	%Mn	%Si	%Cr	%Ni	%Mo	%Ti
Lincolnweld® LA-100	0.10	1.25-1.80	0.20-0.60	0.30	1.40-2.10	0.25-0.55	0.10
	%Zr	%Al	%V	%S	%P	%Cu	
Lincolnweld® LA-100	0.10	0.10	0.05	0.015	0.010	0.25	

## FLUX COMPOSITION<sup>(1)</sup>

	%SiO <sub>2</sub>	%MnO	%MgO	%CaF <sub>2</sub>	%Na <sub>2</sub> O	%Al <sub>2</sub> O <sub>3</sub>	%CaO	%K <sub>2</sub> O	% Metal Alloys
Lincolnweld® MIL800-H™	13	1	34	23	1	16	8	1	1 max

<sup>(1)</sup>Typical all weld metal.

# LINCOLNWELD® P2007™ & 308/308L

Stainless Steel ▪ AWS ER308/ER308L

## KEY FEATURES

- Versatile design to weld several types of austenitic stainless steels
- Produces sound welds with excellent slag removal and bead appearance
- Designed combination to recover nearly all of the wire chromium in the deposit
- Balanced ferrite level for high resistance to hot cracking
- Low carbon content to reduce risk of sensitization of the weld

## TYPICAL APPLICATIONS

- Nuclear reactor vessels and other components

## ASME IX QUALIFICATION

ASME IX Qualification: QW432 F-No 6,  
QW442 A-No 8

## DIAMETERS / PACKAGING - WIRE

Diameter in (mm)	60 lb (27.2 kg) Coil
5/64 (2.0)	ED033147
3/32 (2.4)	ED033148
1/8 (3.2)	ED033149
5/32 (4.0)	ED033150

## DIAMETERS / PACKAGING - FLUX

50 lb (22.7 kg) Plastic Bag
ED033159

## MECHANICAL PROPERTIES<sup>(1)</sup> – As Required per AWS A5.9

	Yield Strength <sup>(2)</sup> MPa (ksi)	Tensile Strength MPa (ksi)	Elongation %	Ferrite Number
<b>Requirements</b> - AWS ER308, ER308L	Not Specified			
<b>Typical Results</b> <sup>(3,5)</sup> - As-Welded	380 (55)	565 (82)	42	15

## WIRE & DEPOSIT COMPOSITION<sup>(1)</sup>

	%C <sup>(4)</sup>	%Cr	%Ni	%Mo	%Mn	%Si
<b>Requirements</b> - AWS ER308L	0.03 max	19.5 - 22.0	9.0 - 11.0	0.75 max	1.0 - 2.5	0.30 - 0.65
<b>Typical Results</b> <sup>(3)</sup>						
Wire Composition	0.02	20.1	9.8	0.10	1.8	0.50
All Weld Metal Composition <sup>(5)</sup>	0.02	19.0 - 19.5	9.8	0.10	1.5 - 1.9	0.50 - 0.80

## TYPICAL OPERATING PROCEDURES

Diameter in (mm)	Wire Feed Speed m/min (in/min)	Voltage (volts)	Current (amps)
5/64 (2.0)	2.0-6.1 (80-240)	24-30	190-500
3/32 (2.4)	1.5-5.3 (60-210)	26-32	195-575
1/8 (3.2)	0.9-2.8 (35-110)	28-34	200-700
5/32 (4.0)	0.8-1.9 (30-75)	30-36	320-775

<sup>(1)</sup>Typical all weld metal. <sup>(2)</sup>Measured with 0.2% offset. <sup>(3)</sup>See test results disclaimer <sup>(4)</sup>AWS Requirement for ER308 is 0.08% max. carbon.

<sup>(5)</sup>Results shown correspond with the recommended Lincolnweld® and Blue Max® fluxes listed above, but not required per AWS A5.9-93.

IMPORTANT: SPECIAL VENTILATION AND/OR EXHAUST REQUIRED

Fumes from the normal use of some welding products can contain significant quantities of components - such as chromium and manganese - which can lower the 5.0 mg/m<sup>3</sup> maximum exposure guideline for general welding fume.

BEFORE USE, READ AND UNDERSTAND THE SAFETY DATA SHEET (SDS) FOR THIS PRODUCT AND SPECIFIC INFORMATION PRINTED ON THE PRODUCT CONTAINER.

# LINCOLNWELD® P2007™ & 309/309L

Stainless Steel ▪ AWS ER309/ER309L

## KEY FEATURES

- Designed to weld stainless steel to mild or low alloy steel
- Produces sound welds with excellent slag removal and bead appearance
- Designed combination to recover nearly all of the wire chromium in the deposit
- Balanced ferrite level for high resistance to hot cracking
- Low carbon content to reduce risk of sensitization of the weld

## TYPICAL APPLICATIONS

- Nuclear reactor vessels and other components

## ASME IX QUALIFICATION

ASME IX Qualification: QW432 F-No 6,  
QW442 A-No 8

## DIAMETERS / PACKAGING - WIRE

Diameter in (mm)	60 lb (27.2 kg) Coil
5/64 (2.0)	ED033151
3/32 (2.4)	ED033152
1/8 (3.2)	ED033153
5/32 (4.0)	ED033154

## DIAMETERS / PACKAGING - FLUX

50 lb (22.7 kg) Plastic Bag
ED033159

## MECHANICAL PROPERTIES<sup>(1)</sup> – As Required per AWS A5.9

	Yield Strength <sup>(2)</sup> MPa (ksi)	Tensile Strength MPa (ksi)	Elongation %	Ferrite Number
Requirements - AWS ER309, ER309L	Not Specified			
Typical Results <sup>(3,5)</sup> - As-Welded	400 (58)	575 (83)	35	8

## WIRE & DEPOSIT COMPOSITION<sup>(1)</sup> – As Required per AWS A5.9

	%C <sup>(4)</sup>	%Cr	%Ni	%Mo	%Mn	%Si
Requirements - AWS ER309L	0.03 max	23.0 - 25.0	12.0 - 14.0	0.75 max	1.0 - 2.5	0.30 - 0.65
Typical Results <sup>(3)</sup>						
Wire Composition	0.02	23.9	13.0	0.15	1.8	0.50
All Weld Metal Composition <sup>(5)</sup>	0.03	23.1 - 23.6	13.0	0.15	1.5 - 2.0	0.50 - 0.80

## TYPICAL OPERATING PROCEDURES

Diameter in (mm)	Wire Feed Speed m/min (in/min)	Voltage (volts)	Current (amps)
5/64 (2.0)	2.0-6.1 (80-240)	24-30	190-500
3/32 (2.4)	1.5-5.3 (60-210)	26-32	195-575
1/8 (3.2)	0.9-2.8 (35-110)	28-34	200-700
5/32 (4.0)	0.8-1.9 (30-75)	30-36	320-775

<sup>(1)</sup>Typical all weld metal. <sup>(2)</sup>Measured with 0.2% offset. <sup>(3)</sup>See test results disclaimer. <sup>(4)</sup>AWS Requirement for ER309 is 0.12% max. carbon.

<sup>(5)</sup>Results shown correspond with the recommended Lincolnweld® and Blue Max® fluxes listed above, but not required per AWS A5.9-93.

IMPORTANT: SPECIAL VENTILATION AND/OR EXHAUST REQUIRED

Fumes from the normal use of some welding products can contain significant quantities of components - such as chromium and manganese - which can lower the 5.0 mg/m<sup>3</sup> maximum exposure guideline for general welding fume.

BEFORE USE, READ AND UNDERSTAND THE SAFETY DATA SHEET (SDS) FOR THIS PRODUCT AND SPECIFIC INFORMATION PRINTED ON THE PRODUCT CONTAINER.

# LINCOLNWELD® P2007™ & 316/316L

Stainless Steel ▪ AWS ER316/ER316L

## KEY FEATURES

- Designed to weld stainless steels for higher pitting corrosion resistance
- Produces sound welds with excellent slag removal and bead appearance
- Designed combination to recover nearly all of the wire chromium in the deposit
- Balanced ferrite level for high resistance to hot cracking
- Low carbon content to reduce risk of sensitization of the weld

## TYPICAL APPLICATIONS

- Nuclear reactor vessels and other components

## ASME IX QUALIFICATION

ASME IX Qualification: QW432 F-No 6,  
QW442 A-No 8

## DIAMETERS / PACKAGING - WIRE

Diameter in (mm)	60 lb (27.2 kg) Coil
5/64 (2.0)	ED033155
3/32 (2.4)	ED033156
1/8 (3.2)	ED033157
5/32 (4.0)	ED033158

## DIAMETERS / PACKAGING - FLUX

50 lb (22.7 kg) Plastic Bag
ED033159

## MECHANICAL PROPERTIES<sup>(1)</sup> – As Required per AWS A5.9

	Yield Strength <sup>(2)</sup> MPa (ksi)	Tensile Strength MPa (ksi)	Elongation %	Ferrite Number
<b>Requirements</b> - AWS ER316, ER316L	Not Specified			
<b>Typical Results</b> <sup>(3,5)</sup> - As-Welded	380 (55)	550 (80)	42	9

## WIRE COMPOSITION<sup>(1)</sup> – As Required per AWS A5.9

	%C <sup>(4)</sup>	%Cr	%Ni	%Mo	%Mn	%Si
<b>Requirements</b> - AWS ER316L	0.03 max	18.0 - 20.0	11.0 - 14.0	2.0 - 3.0	1.0 - 2.5	0.30 - 0.65
<b>Typical Results</b> <sup>(3)</sup> As-Welded	0.02	19.0	11.9	2.2	1.8	0.50
All Weld Metal Composition <sup>(5)</sup>	0.02	17.8 - 18.4	11.9	2.2	1.6 - 2.0	0.50 - 0.80

## TYPICAL OPERATING PROCEDURES

Diameter - in (mm)	Wire Feed Speed - m/min (in/min)	Voltage (volts)	Current (amps)
5/64 (2.0)	2.0-6.1 (80-240)	24-30	190-500
3/32 (2.4)	1.5-5.3 (60-210)	26-32	195-575
1/8 (3.2)	0.9-2.8 (35-110)	28-34	200-700
5/32 (4.0)	0.8-1.9 (30-75)	30-36	320-775

<sup>(1)</sup>Typical all weld metal. <sup>(2)</sup>Measured with 0.2% offset. <sup>(3)</sup>See test results disclaimer <sup>(4)</sup>AWS Requirement for ER316 is 0.08% max. carbon.

<sup>(5)</sup>Results shown correspond with the recommended Lincolnweld® and Blue Max® fluxes listed above, but not required per AWS A5.9-93.

IMPORTANT: SPECIAL VENTILATION AND/OR EXHAUST REQUIRED

Fumes from the normal use of some welding products can contain significant quantities of components - such as chromium and manganese - which can lower the 5.0 mg/m<sup>3</sup> maximum exposure guideline for general welding fume.

BEFORE USE, READ AND UNDERSTAND THE SAFETY DATA SHEET (SDS) FOR THIS PRODUCT AND SPECIFIC INFORMATION PRINTED ON THE PRODUCT CONTAINER.

# ULTRACORE® 71A85

Mild Steel ▪ AWS E71T-1M-H8, E71T-9M-H8

## KEY FEATURES

- Q2 Lot® - Certificate showing actual deposit chemistry and mechanical properties available online
- Available as Batch Managed Inventory
- Fast freezing slag for out-of-position welding
- Designed for welding with 75-85% Argon/balance CO<sub>2</sub> shielding gas
- Premium arc performance and bead appearance
- Meets AWS D1.8 seismic lot waiver requirements
- Each spool is identified with AWS classification and LOT number

## WELDING POSITIONS

All

## CONFORMANCES

<b>AWS A5.20:</b>	E71T-1M-H8, E71T-9M-H8
<b>ASME SFA-A5.20:</b>	E71T-1M-H8, E71T-9M-H8
<b>ABS:</b>	3YSA H10
<b>Lloyd's Register:</b>	3YS H10
<b>DNV Grade:</b>	III YMS H10
<b>CWB/CSA W48-06:</b>	E491T-9M H8
<b>EN ISO 17632-B:</b>	T493T1-1MA-H10
<b>FEMA 353</b>	
<b>AWS D1.8</b>	

## TYPICAL APPLICATIONS

- Shipbuilding
- Seismic structural fabrication
- General fabrication
- Nuclear power plant construction and maintenance

## ASME IX QUALIFICATION

ASME IX Qualification:	QW432 F-No 6, QW442 A-No 1
------------------------	-------------------------------

## DIAMETERS / PACKAGING

Diameter in (mm)	33 lb (15 kg) Plastic Spool
0.045 (1.1)	ED033950
1/16 (1.6)	ED033951

**MECHANICAL PROPERTIES<sup>(1)</sup> – As Required per AWS A5.20**

	Yield Strength <sup>(2)</sup> MPa (ksi)	Tensile Strength MPa (ksi)	Elongation %	Charpy V-Notch J (ft-lbf)	
				@ -18°C (0°F)	@ -29°C (-20°F)
<b>Requirements<sup>(4)</sup></b> AWS E71T-1M-H8, AWS E71T-9M-H8	400 (58) min	480-655 (70-95)	22 min	27 (20) min Not Specified	Not Specified 27 (20) min
<b>Typical Results<sup>(3)</sup></b> As-Welded with 75%-85% Ar/balance CO <sub>2</sub>	550-600 (80-88)	600-650 (87-94)	24 - 26	64-115 (47-85)	43-95 (32-70)

**DEPOSIT COMPOSITION<sup>(1)</sup> – As Required per AWS A5.20**

	%C	%Mn	%Si	%S	%P	Diffusible Hydrogen (mL/100g weld deposit)
<b>Requirements<sup>(4)</sup></b> AWS E71T-1M-H8, E71T-9M-H8	0.12 max	1.75 max	0.90 max	0.03 max	0.03 max	8.0 max
<b>Typical Results<sup>(3)</sup></b> As-Welded with 75%-85% Ar/balance CO <sub>2</sub>	0.03-0.04	1.43-1.56	0.52-0.59	<0.01	0.01	6-8

**TYPICAL OPERATING PROCEDURES**

Diameter, Polarity Shielding Gas	CTWD <sup>(5)</sup> mm (in)	Wire Feed Speed m/min (in/min)	Voltage (volts)	Approx. Current (amps)	Melt-Off Rate kg/hr (lb/hr)	Deposition Rate kg/hr (lb/hr)	Efficiency (%)
<b>0.045 in (1.1 mm), DC+</b> 75%-85% Ar/ balance CO <sub>2</sub>	25 (1)	4.4 (175)	21-26	125	1.8 (4.0)	1.6 (3.5)	86-88
		6.4 (250)	22-27	150	2.6 (5.7)	2.3 (5.0)	
		7.6 (300)	23-28	165	3.1 (6.8)	2.7 (6.0)	
		8.9 (350)	23-29	190	3.6 (8.0)	3.2 (7.0)	
		10.2 (400)	25-30	205	4.1 (9.1)	3.6 (8.0)	
		11.4 (450)	26-31	225	4.7 (10.3)	4.1 (9.0)	
		12.7 (500)	27-32	245	5.2 (11.4)	4.5 (10.0)	
		14.0 (550)	28-33	265	5.7 (12.5)	5.0 (10.9)	
15.2 (600)	28-34	280	6.2 (13.7)	5.4 (11.9)			
<b>1/16 in (1.6 mm), DC+</b> 75%-85% Ar/ balance CO <sub>2</sub>	25 (1)	3.2 (125)	20-25	185	2.4 (5.3)	2.1 (4.6)	86-88
		4.4 (175)	21-26	215	3.3 (7.4)	2.9 (6.4)	
		5.1 (200)	22-27	235	3.8 (8.4)	3.3 (7.3)	
		5.7 (225)	23-28	265	4.3 (9.5)	3.7 (8.2)	
		6.4 (250)	24-29	285	4.8 (10.5)	4.2 (9.2)	
		7.6 (300)	25-30	315	5.7 (12.6)	5.0 (11.0)	
		8.3 (325)	26-31	335	6.2 (13.7)	5.4 (11.9)	
		8.9 (350)	27-32	365	6.7 (14.7)	5.8 (12.8)	
10.2 (400)	28-33	385	7.6 (16.8)	6.6 (14.6)			

<sup>(1)</sup>Typical all weld metal. <sup>(2)</sup>Measured with 0.2% offset. <sup>(3)</sup>See test results disclaimer <sup>(4)</sup>As-Welded with 75%-85% Argon/Balance CO<sub>2</sub> <sup>(5)</sup>To estimate ESO, subtract 1/4 in (6.0 mm) from CTWD.  
NOTE 1: FEMA and AWS D1.8 structural steel seismic supplement test data can be found on this product at [www.lincolnelectric.com](http://www.lincolnelectric.com). NOTE 2: This product contains micro-alloying elements.  
Additional information available upon request.

# ULTRACORE® SR-12H

Mild Steel ■ AWS E71T-1M-JH4, E71T-9M-JH4, E71T-12M-JH4

## KEY FEATURES

- Capable of producing weld deposits with impact toughness of 70 - 110 ft•lbs @ -40°F (as welded and after 8 hrs. PWHT @ 1150°F).
- Meets H4 diffusible hydrogen levels
- Q2 Lot® - Certificate showing actual deposit chemistry and mechanical properties per lot available online
- Prior to using this material for ASME Boiler and Pressure Vessel Code Section III applications, please contact the Lincoln Electric Specials Department to receive a Certified Material Test Report (CMTR) which meet all requirements of NCA-3860

## WELDING POSITIONS

All

## SHIELDING GAS

75-80% Argon / Balance CO<sub>2</sub>

## CONFORMANCES

- AWS A5.20:** E71T-1M-JH4, E71T-9M-JH4, E71T-12M-JH4
- ASME SFA-5.20** E71T-1M-JH4, E71T-9M-JH4, E71T-12M-JH4

## TYPICAL APPLICATIONS

- Nuclear applications
- Applications requiring PWHT of mild steel

## ASME IX QUALIFICATION

ASME IX Qualification: QW432 F-No 6, QW442 A-No 1

## DIAMETERS / PACKAGING

Diameter in (mm)	15 lb (7 kg) Plastic Spool 60 lb (28 kg) Carton
0.045 (1.2)	ED034122

**MECHANICAL PROPERTIES<sup>(1)</sup> – As Required per AWS A5.20**

	Yield Strength <sup>(2)</sup> MPa (ksi)	Tensile Strength MPa (ksi)	Elongation %	Charpy V-Notch J (ft-lbf) @ -40 °C (-40 °F)
<b>Requirements</b> - AWS E71T-12M-JH4 As-Welded with 75% Ar / 25% CO <sub>2</sub>	400 (58) min	480-620 (70-90)	22 min	27 (20) min
<b>Typical Results<sup>(3)</sup></b> As-Welded with 75% Ar / 25% CO <sub>2</sub> Stress-Relieved for 8 hrs. @ 620 °C (1150 °F)	510-550 (74-80) 450 (65)	570-600 (83-87) 540 (78)	25-32 30	110-200 (80-150) 100-150 (70-110)

**DEPOSIT COMPOSITION<sup>(1)</sup> – As Required per AWS A5.20**

	%C	%Mn	%Si	%Ni
<b>Requirements</b> - AWS E71T-12M-JH4 As-Welded with 75% Ar / 25% CO <sub>2</sub>	0.12 max	1.60 max	0.90 max	0.50 max
<b>Typical Results<sup>(3)</sup></b> As-Welded with 75% Ar / 25% CO <sub>2</sub>	0.03-0.06	1.27-1.60	0.27-0.45	0.34-0.41
	%S	%P	Diffusible Hydrogen (mL/100g weld deposit)	
<b>Requirements</b> - AWS E71T-12M-JH4 As-Welded with 75% Ar / 25% CO <sub>2</sub>	0.03 max	0.03 max	4 max	
<b>Typical Results<sup>(3)</sup></b> As-Welded with 75% Ar / 25% CO <sub>2</sub>	<0.01	<0.01	1-4	

**TYPICAL OPERATING PROCEDURES**

Diameter, Polarity Shielding Gas	CTWD <sup>(4)</sup> mm (in)	Wire Feed Speed m/min (in/min)	Voltage (Volts)	Approx. Current (Amps)	Melt-Off Rate kg/hr (lb/hr)	Deposition Rate kg/hr (lb/hr)	Efficiency (%)
0.045 in. (1.1 mm), DC+ 75-80% Ar / balance CO <sub>2</sub>	22 (7/8)	4.4 (175)	22-24	125	1.8 (4.0)	1.5 (3.4)	88
		5.7 (225)	22-24	145	2.3 (5.1)	2.0 (4.4)	
		7.0 (275)	23-25	165	2.9 (6.3)	2.5 (5.5)	
		8.3 (325)	23-25	185	3.4 (7.4)	2.9 (6.4)	
		9.5 (375)	24-26	205	3.9 (8.6)	3.4 (7.5)	
		10.8 (425)	25-27	225	4.4 (9.7)	3.8 (8.4)	
12.1 (475)	26-28	245	4.9 (10.9)	4.3 (9.5)			

<sup>(1)</sup> Typical all weld metal. <sup>(2)</sup> Measured with 0.2% offset. <sup>(3)</sup> See test results disclaimer. <sup>(4)</sup> To estimate ESO, subtract 1/4 in. (6.0 mm) from CTWD.  
Note: This product contains micro-alloying elements. Additional information available upon request.





CONSUMABLES  
**PACKAGING**

*Options*

Tubes, Cans & Cartons..... L-1  
Reels & Stem..... L-3  
Spools..... L-5  
Coils, Boxes & Bags ..... L-7  
Drums & Pails ..... L-9

*Storage and Handling*

Stick Electrode .....L-11  
Stainless Steel & Nickel.....L-12  
Metal-Cored & Flux-Cored Wire .....L-13  
Solid Wires & Submerged Arc Flux.....L-14  
Accu-Pak® Box .....L-15  
Accu-Trak® Drum and Speed-Feed® Drum .....L-16

# TUBES, CANS & CARTONS

## 5 lb Plastic Tube

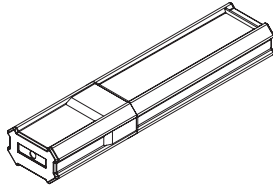

## Easy Open (EO) Hermetic Cans

25 & 50 lb EO Can    8 & 10 lb EO Can

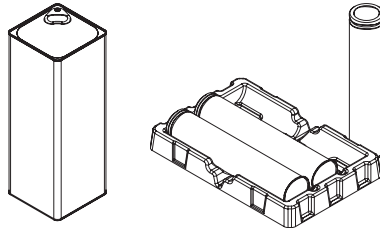

## 5, 10, 50 lb Cardboard Carton

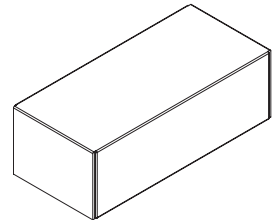

## TUBES, CANS & CARTONS

Package Type	Weight (lbs)	Width (in) / Diameter (in)	Height (in)
<i>Tubes</i>			
Tubes	1	1.16	8.3
	5	2.18	14.45
<i>Hermetic Cans</i>			
Easy Open (EO) Cans	8	3	12.62
	10	3	14.62
	25	5	12.62
	50	5	14.62
<i>Carton</i>			
Cardboard Carton	5	1.25	14.25
	10	2.25	14.25
	50	4.75	14.56

Notes: Electrodes come in 12, 14 & 18 inches (300, 350 & 450 mm) lengths.

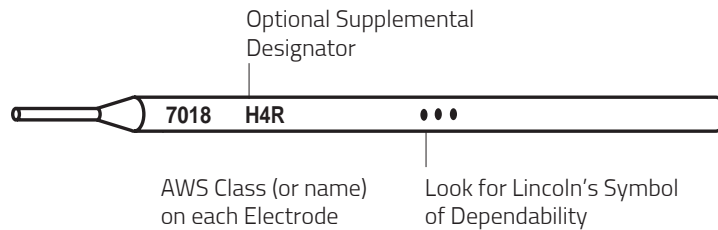

# TUBES, CANS & CARTONS

STICK



Easy Open Cans  
10 lb & 50 lb



Plastic Tubes  
5 lb



Cardboard Carton  
5, 10, 50 lb



Plastic Tube  
1 lb

# REELS & STEM

## REELS

Wire Type	Weight (lbs)	Wire Diameter Specifications	"D" Outer Diameter (in)	"W" Outer Width (in)	"D1" Arbor Hole Diameter (in)	"D2" Pin Hole Diameter (in)	"A" Pin Hole Distance from Axis (in)
-----------	--------------	------------------------------	-------------------------	----------------------	-------------------------------	-----------------------------	--------------------------------------

### Speed-Feed® Reels

Solid	300	-	30	12.75	1.31	0.68	2.5
	750	≤ 1/16 in	30	12.75	1.34	0.75	2.5
	750	≥ 5/64 in	30	12.75	1.31	0.68	2.5
	1000	≤ 1/16 in	30	12.75	1.34	0.75	2.5
	1000	≥ 5/64 in	30	12.75	1.31	0.68	2.5
Flux-Cored	300	-	23.75	11.25	1.31	0.68	2.5
	600	≤ 1/16 in	30	12.75	1.34	0.75	2.5
	600	≥ 5/64 in	30	12.75	1.31	0.68	2.5
	900	-	30	12.75	1.31	0.68	2.5

### Precise-Trak® Reel

Solid	1000	-	30	19.5	1.31	0.68	2.5
-------	------	---	----	------	------	------	-----

### Speed-Feed® SlimReel

Solid	250	-	29.75	6.18	1.31	1.31	8.75
-------	-----	---	-------	------	------	------	------

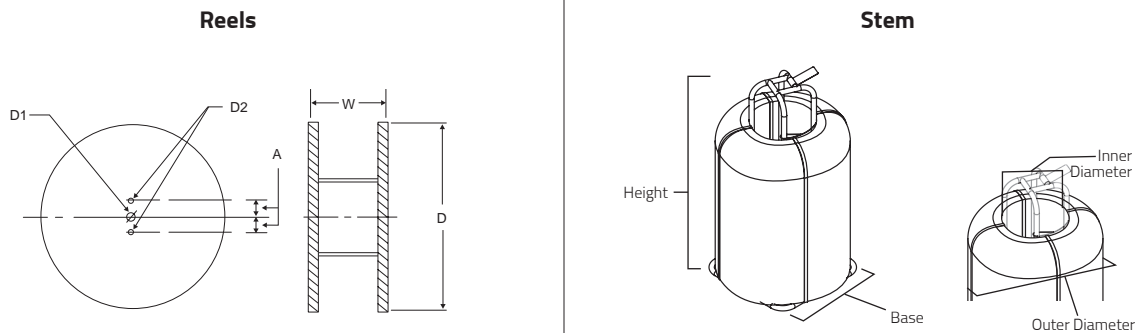

## STEM

Wire Type	Weight (lbs)	Base	Stem Height (in)	Wire Stack (in)	
				Inner Diameter	Outer Diameter

### Speed-Feed® Stem

Solid	2200-3000	27.4 x 27.4	54	16	32 - 34
-------	-----------	-------------	----	----	---------

# REELS & STEMS

REELS



**Precise-Trak® Reel**  
with Rotary Dispenser (K895-2)

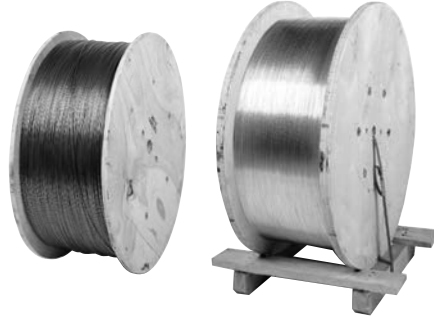

**Vertical Speed-Feed®(1) Reel**  
left: Flux-Cored, right: Solid



**Speed-Feed®(1) Reel**  
left: Flux-Cored, right: Solid



**Speed-Feed®(1) SlimReel™**  
Solid

STEMS



**Speed-Feed®(1) Stem**

<sup>(1)</sup> Needs to be rotated to payoff wire

# SPOOLS

**Plastic/Fiber Spools**

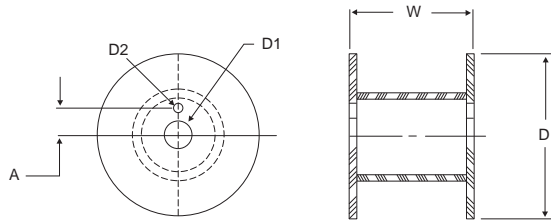

**Steel Spools**

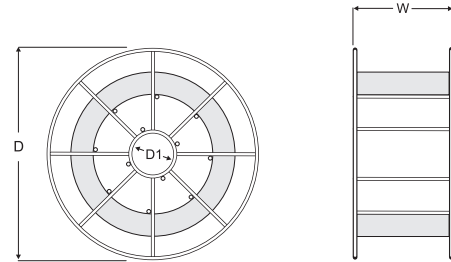

## SPOOLS

Wire Type	Weight (lbs)	"D" Outer Diameter (in)	"D1" Inner Diameter (in)	"W" Wound Reel Outer Width (in)	"D1" Arbor Hole Diameter (in)	Pin Hole "D2" Diameter (in)	Pin Hole "A" Distance from Axis (in)
<i>Steel Spools</i>							
Solid or Flux-Cored	25	11.81	2.05	4.25	-	-	-
	33	11.81	2.05	4.25	-	-	-
	44	11.81	2.05	4.25	-	-	-
<i>Plastic Spools</i>							
Solid (Mild Steel)	2	4.00	-	1.75	0.63	-	-
	10	8.00	-	2.16	2.03	0.44	1.75
	11	8.00	-	2.16	2.03	0.44	1.75
	12.5	8.00	-	2.16	2.03	0.44	1.75
	33	12.00	-	4.19	2.03	0.44	1.75
Solid (Copper Alloys)	33	12.00	-	4.19	2.03	0.44	1.75
Solid (Aluminum)	1	4.00	-	1.75	0.28	-	-
	16	11.88	-	4.00	2.00	0.47	1.75
	20	11.88	-	4.00	2.00	0.47	1.75
Flux-Cored/ Metal-Cored	10	8.00	-	2.16	2.03	0.44	1.75
	15	8.00	-	3.00	2.03	0.44	1.75
	25	12.00	-	4.00	2.03	0.44	1.75
	33	12.00	-	4.00	2.03	0.44	1.75
<i>Fiber Spools</i>							
Solid	44	12.00	-	4.30	2.03	0.44	1.75
	60	14.00	-	4.30	2.03	0.44	1.75
Flux-Cored	33	12.00	-	4.30	2.03	0.44	1.75
	50	14.00	-	4.30	2.03	0.44	1.75

# SPOOLS

SPOOLS



**Steel Spool**  
Solid & Flux-Cored - 33 lb



**Plastic Spool**  
Flux-Cored - 25 lb, 1 lb



**Plastic Spool**  
Solid, Mild Steel - 33 lb, 12.5 lb, 2 lb,  
Solid, Copper Alloys - 33 lb



**Plastic Spool**  
Solid, Aluminum - 16 lb, 1 lb



**Fiber Spool**  
Solid, Mild Steel - 60 lb, Flux-Cored - 33 lb, 44 lb, 50 lb



# COILS, BOXES & BAGS

## COILS

Wire Type	Weight (lbs)	Wire Diameter Specifications	"D" Outer Diameter (in)	"D1" Inner Diameter (in)	"W" Wound Reel Outer Width (in)
Solid	55 & 60	≤ 1/16 in	16.50	12.00	4.40
	55 & 60	≥ 5/64 in	16.50	12.00	4.60
Flux-Cored	14	-	9.50	6.70	3.00
	50 & 60	-	16.50	12.00	4.60

*Coils*

## COIL ADAPTERS

System	Part #	Description
Automatic wire feeders - LT-7 Tractor systems	K299	Wire reel adapter for 50 lb & 60 lb coils
SAW coil adapter for 2 inch (51mm) spindle	K1504-1	Spindle adapter for 50 lb & 60 lb coils
FCAW coil adapter for 2 inch (51mm) spindle	K435	Spindle adapter For 14 lb coils

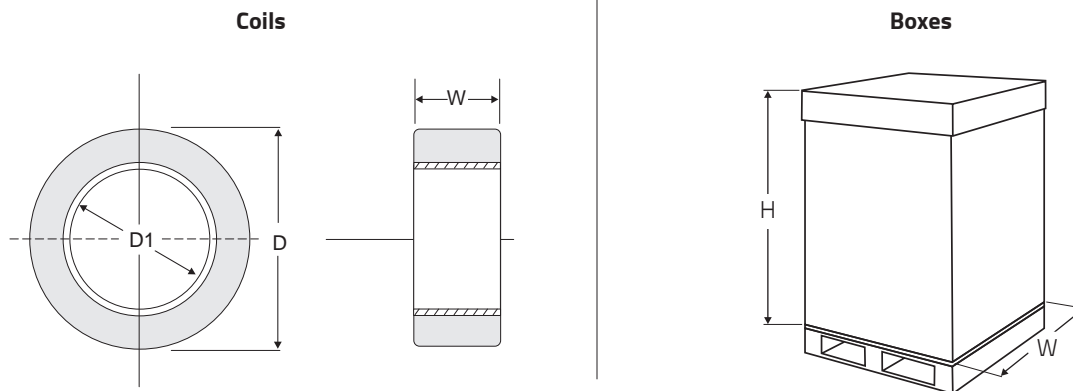

## BOXES

Wire Type	Weight (lbs)	Outside Dimensions L x W x H (in)	Core Dimensions (in)
<i>Gem-Pak® Box</i>			
Solid (Aluminum)	300	24 x 24 x 32	14
Solid (Copper Alloys)	500	24 x 24 x 32	14
<i>Accu-Pak® Box</i>			
Solid (Mild Steel)	500	21 x 21 x 28	-
	900-1000	24 x 24 x 32	-

## BAGS

Wire Type	Weight (lbs)	Dimensions (in)
<i>Paper Bag / Plastic Bag / Sahara ReadyBag™</i>		
Flux	50	-
<i>Bulk Bag</i>		
Flux	2600 - 3000	43 x 43 x 48 <sup>(1)</sup>

<sup>(1)</sup>Values are maximums.

# COILS, BOXES & BAGS

**COILS**



**Flux-Cored**  
14 lb Coil (56 lb HS Pail)



**Flux-Cored**  
50 lb



**Solid Wire**  
60 lb

**COIL ADAPTERS**



**Wire Reel Assembly**  
Accommodates 50 lb & 60 lb



**Coil Adapter 60 lb**  
Accommodates 50 lb & 60 lb



**Spindle Adapter For 14 lb Coils**  
Accommodates 14 lb

**BOXES**



**Accu-Pak® Boxes**  
1500, 1000 & 500 lb

**BAGS**



**Paper Bag**



**Plastic Bag**



**Sahara ReadyBag™**



**Bulk Bag**

# DRUMS & PAILS

Drums

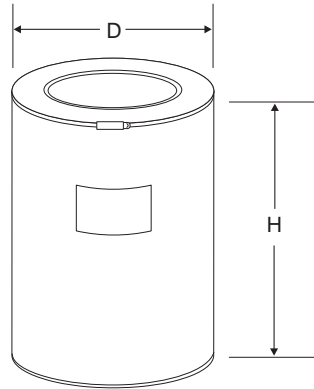

## DRUMS

Wire Type	Weight (lbs)	Outer Diameter (in)	Outer Height (in)	Core Inside Diameter	Core Height
<i>Speed-Feed® Drum</i>					
Solid	300	23.4	17.8	16	17
	600	23.4	34.8	16	34
	1000	23.4	34.8	16	34
Flux-Cored	125	23.4	11.1	16	10
	300	23.4	17.8	16	17
	500 and 600	23.4	34.8	16	17
<i>Accu-Trak® Drum</i>					
Solid	250	23.4	19.7	-	-
	500	20.4	32.6	-	-
	1000	23.4	34.8	-	-
Flux-Cored	300, 400 and 500	20.4	32.6	8.4	31.5
	500 and 600	23.4	34.8	8.4	34
Metal-Cored	500	20.4	32.6	8.4	31.5
<i>Mini-Drum</i>					
Solid (Aluminum)	60	20.4	13	-	-
<i>Steel Drum</i>					
Flux	550	22.75	33.50	-	-

## PAILS

Wire Type	Weight (lbs)	Outer Diameter (in)	Outer Height (in)	Core Inside Diameter	Core Height
<i>Hermetically Sealed Pail</i>					
Flux	50	12	14.75	-	-

# DRUMS & PAILS

DRUMS



Mini Drum/Accu-Trak®/Speed-Feed<sup>(1)</sup> Drums



Steel Drum<sup>(2)</sup>

PAIL



Hermetically Sealed Pail



Hermetically Sealed Pail as Master

<sup>(1)</sup> Needs to be rotated to payoff wire. <sup>(2)</sup> This product does not come on a pallet. If your application requires a pallet, please contact your local Lincoln Electric sales representative.

# STICK ELECTRODES

## Storage & Handling

### STORING LOW HYDROGEN ELECTRODES

Low hydrogen electrodes must be dry to perform properly. Unopened hermetically sealed containers provide excellent protection in good storage conditions. Opened cans or electrodes should be stored in a cabinet at 120° - 150°C (250° - 300°F).

Moisture resistant electrodes with an "R" suffix have a high resistance to coating moisture pick-up.

However, all low hydrogen electrodes should be stored properly, even those with an "R" suffix. Standard EXX18 electrodes should be supplied to welders twice per shift. Moisture resistant types may be exposed for up to 9 hours. Specific code requirements may indicate exposure limits different from these guidelines.

Depending on the amount of moisture absorbed and other factors, moisture pick-up can degrade weld quality in various ways:

1. Moisture in low hydrogen electrodes may cause porosity. This porosity could be completely subsurface and require x-ray inspection or destructive testing. The porosity could also be visible, external porosity.
2. High moisture can also lead to excessive slag fluidity, a rough weld surface, and difficult slag removal.
3. Excessive moisture in low hydrogen electrodes will lead to elevated levels of diffusible hydrogen which, in turn, can lead to hydrogen-induced weld cracking and/or underbead cracking.

### RE-DRYING LOW HYDROGEN ELECTRODES

Re-drying, when done correctly, restores the electrodes' ability to deposit quality welds. Proper re-drying temperature depends upon the electrode type and its condition. One hour at the listed final temperature is satisfactory. DO NOT dry electrodes at higher temperatures. Several hours at lower temperatures is not equivalent to using the specified requirements.

Electrodes of the E8018 and higher strength classifications should be given no more than three 1-hour re-dries in the 370° - 430°C (700° - 800°F) range. This minimizes the possibility of oxidation of alloys in the coating which would result in lower than normal tensile or impact properties.

Any low hydrogen electrode should be discarded if excessive re-drying causes the coating to become fragile and flake or break off while welding, or if there is a noticeable difference in handling or arc characteristics, such as insufficient arc force.

Electrodes to be re-dried should be removed from the can and spread out in the oven because each electrode must reach the drying temperature.

### STORING CELLULOSIC ELECTRODES

Electrodes in unopened Lincoln cans or cartons retain the proper moisture content indefinitely when stored in good condition.

If exposed to humid air for long periods of time, electrodes from opened containers may pick up enough moisture to affect operating characteristics or weld quality. If moisture appears to be a problem, store electrodes from the opened containers in heated cabinets at 40° to 50°C (100° to 120°F).

### STORING AND RE-DRYING NON-LOW HYDROGEN ELECTRODES

Electrodes in unopened Lincoln cans or cartons retain the proper moisture content indefinitely when stored in good condition.

If exposed to humid air for long periods of time, electrodes from opened containers may pick up enough moisture to affect operating characteristics or weld quality. If moisture appears to be a problem, store electrodes from the opened containers in heated cabinets at 40° to 50°C (100° to 120°F). DO NOT use higher temperatures.

Some electrodes from wet containers or long exposure to high humidity can be re-dried. Follow the procedures below for each type.

*Using longer drying times or higher temperatures can easily damage the electrodes.*

For drying, remove the electrodes from the container and spread them out in the furnace because each electrode must reach the drying temperature.

# STICK ELECTRODES

## Storage & Handling

### RE-DRYING CONDITIONS - LOW HYDROGEN

Condition	Pre-drying Temperature <sup>(1)</sup>	Final Re-drying Temperature
Electrodes exposed to air for less than one week; no direct contact with water.	—	370° - 430°C (700° - 800°F)
Electrodes which have come in direct contact with water or which have been exposed to high humidity.	80 - 105°C (180° - 220°F)	370° - 430°C (700° - 800°F)

### RE-DRYING CONDITIONS - NON-LOW HYDROGEN

Electrode	Electrode Group	Final Re-drying Temperature	Time
E6010: E6011: E7010-A1 <sup>(1)</sup> : E7010-G <sup>(1)</sup> : E8010-G <sup>(1)</sup> : E9010-G <sup>(1)</sup> :	Excessive moisture is indicated by a noisy arc and high spatter, rusty cored wire at the hold end or objectionable coating blisters while welding.  Rebaking of this group of electrodes is not recommended.	Not Recommended	—
E7024: E6027:	Excessive moisture is indicated by a noisy or "digging" arc, high spatter, tight slag, or undercut. Pre-dry unusually damp electrodes for 30 - 45 minutes at 90°C to 110°C (200°F to 230°F) before final drying to minimize cracking of the coating.	200° - 260°C (400° - 500°F)	30 - 45 minutes
E6013: E7014: E6022:	Excessive moisture is indicated by a noisy or "digging" arc, high spatter, tight slag, or undercut. Pre-dry unusually damp electrodes for 30 - 45 minutes at 90°C to 110°C (200°F to 230°F) before final drying to minimize cracking of the coating.	150° - 180°C (300° - 350°F)	20 - 30 minutes

<sup>(1)</sup>Pre-dry for 1-2 hours.

# STAINLESS STEEL & NICKEL

## Storage & Handling

### STORING STAINLESS STEEL AND NICKEL

Excalibur® stainless steel covered electrodes should be handled and stored as if they were low hydrogen electrodes for welding low steels. They should be protected from moisture pickup. The consequences of moisture pickup with Excalibur stainless electrodes do not include cold cracking, as would be the case with low alloy steels, unless they are used for dissimilar metal joining. But if Excalibur stainless electrodes are exposed for extended periods a humid environment, the coating can pick up

enough moisture to cause starting porosity and/or center line porosity. The electrode should be stored in sealed cans, or stored in an oven at about 120°C (250°F); this is also recommended for flux-cored wires. Plastic spools can be baked up to 66°C (150°F) with no issues. Stainless can be restored to like new conditions by baking one hour at 345-425°C (650-800°F). Nickel electrodes should be reconditioned before by baking in drying oven for 1-2 hours at 204-260°C (400-500°F).

# METAL-CORED & FLUX-CORED WIRE

## Storage & Handling

### SHELF LIFE

As a general rule, The Lincoln Electric Company estimates maximum storage time for mild and low alloy steel consumables to be 3 years. This estimate is for material in the original, undamaged packages that is stored indoors at up to ~70% relative humidity and that are protected from the weather or other adverse conditions. Packages should be stored under conditions that minimize the likelihood of temperature variations that cause moisture condensation on the consumables.

These estimates are based on what we know about the packaging materials and the frequency of product improvements. Since actual storage conditions vary widely across geographical regions and from one customer to another, it is not possible to be more specific. For packages that are not hermetically sealed, a shorter storage time is advisable under sustained severe humidity conditions but is not possible to estimate. Note that product stored for longer than 3 years, may still be suitable for use. It depends on the product and the condition it is in.

*Dispose of any wire or rod that has visible signs of rust.*

Customers are not encouraged to store consumables for extended periods of time. It is advisable to maintain turnover in inventory to ensure the products are as close to their as manufactured conditions as can be reasonably expected. The general guidelines above are provided for those unplanned instances where product is stored longer than originally anticipated.

### STORAGE OF UNOPENED PACKAGES

FCAW products should be stored in the original, unopened packaging until ready to use. To maintain the integrity of these products, electrodes must be protected from the atmosphere. All flux cored electrodes, regardless of package, should be protected from condensation, including rain or snow. To ensure that condensation does not form on the product, it is recommended that the electrode be stored in an environment that is kept above the dew point temperature for a given relative humidity. Minimizing temperature variation will also help to protect the electrode from moisture condensation. It is advisable to maintain turnover in inventory to ensure the product is as close to the manufactured condition as possible.

*For applications in which the weld metal hydrogen must be controlled (usually 8 mL/100g or lower), or where shipping and storage conditions are not controlled or known; only hermetically sealed packaging is recommended.*

### HANDLING OF WIRES OUT OF THE PACKAGE

*The following minimum precautions should be taken to safeguard the wire after opening the original package:*

- It is recommended to use wires within one week of opening the original package.
- Open wires should not be exposed to damp moisture conditions or extremes in temperature and/or humidity where surface condensation can occur.
- When not in use, wires should be placed in original packaging and sealed as best as possible.
- If exposed to moisture conditions, discard any rusty wire.
- After exposure, hydrogen levels can be reduced by conditioning the wire. Wires may be conditioned at a temperature of 212°F ± 25°F (100°C ± 4°C) for a period of 6 to 12 hours, cooled and then stored in a sealed poly bags (4 mil minimum thickness) or equivalent. Wire on plastic spools should not be heated at temperatures in excess of 150°F (65°C).

### WHEN TO DISPOSE OF PRODUCT

It is advisable to dispose of any wire that has visible signs of rust on the wire where the package integrity has been compromised. When proper storage procedures are not followed, consumables may show signs of high moisture. High moisture can result in rough bead surface or slag that is unusually difficult to remove. In addition, it can also result in visible and/or internal porosity in the weld deposit, increase spatter, and decreased puddle control which can increase chances of slag entrapment. Oxidation (rust) of either the surface of the wire or internal fluxing agents increases the oxygen content of the wire that can lead to changes in alloy recovery. This, in turn, can deteriorate the mechanical properties of the weld metal.

# SOLID WIRES & SUBMERGED ARC FLUX

## Storage & Handling

### STORAGE FOR SUBMERGED ARC FLUX

Flux Package Type <sup>(1)</sup>	Flux Storage Conditions for General Welding Applications	Flux Storage for Applications Requiring Diffusible Hydrogen Control
Plastic or Multi-Wall Plastic/Paper Bag	Store indoors at < 90% RH Protect from condensation	Store indoors at < 70% RH and 5°C - 50°C (40°F - 122°F). Protect from condensation
Bulk Bag with Liner	Store indoors at < 90% RH Protect from condensation	Store indoors at < 70% RH and 5°C - 50°C (40°F - 122°F). Protect from condensation
Steel Drum	Protect from rain or snow	Protect from rain or snow
Plastic Pail	Protect from rain or snow	Protect from rain or snow
Sahara ReadyBag™	Protect from rain or snow	Protect from rain or snow

### STORAGE FOR ALL MIG, TIG, AND SAW SOLID WIRES<sup>(2)</sup>

Wire Package Type <sup>(1)</sup>	Wire Storage Conditions for All Welding Applications
Any Type	Protect from rain or snow. Protect from condensation. DO NOT use wire with visible signs of rust.

<sup>(1)</sup>For other package types, consult your Technical Representative. <sup>(2)</sup>All as in Stainless, Nickel, Low Alloy, and Mild Solid Wires.

### RE-DRYING & RECYCLING FLUX

Lincoln Electric submerged arc welding flux can be used directly from its original, undamaged package, if it has been stored according to the conditions listed in the chart above.

When proper procedures are not followed, flux may show signs of moisture. These can include porosity, a rough bead surface or slag that is unusually difficult to remove. In many instances these fluxes can be re-dried in general welding applications.

### RE-DRYING FLUX

#### To re-dry fluxes other than MIL800-H, MIL800-HPNi and 842-H fluxes

- Remove flux from its original packaging and place in a clean oven set between 260°-480°C (500°-900°F).
- Leave in oven long enough to raise the temperature of the entire bulk of flux to your set temperature for a minimum of one hour.
- For ovens in which heating rods are inserted into the flux, do not let the temperature of flux adjacent to the rods exceed 480°C (900°F).
- For all other applications requiring diffusible hydrogen control set temperature at approximately 425°C (800°F).

#### For MIL800-H, MIL800-HPNi and 842-H fluxes

Follow all previous procedures, with the following changes:

- Set temperature between 120°-205°C (250°-400°F).
- For ovens in which heating rods are inserted into the flux, do not let the temperature of flux adjacent to the rods exceed 205°C (400°F).

### RECYCLING FLUX

**Non-consumed flux may be collected from the finished weld and recycled.** *To do so, please follow these procedures:*

- Remove slag, metal, mill scale, and any other contaminants from the flux.
- Prevent damage to the flux from heavy impingement in flux transport systems.
- Avoid the separation of different sized particles in cyclones or "dead" corners.
- Remove excess fines from recycled fluxes.
- For optimal welding characteristics, it is recommended to add at least 20% new flux by weight to recycled flux.



# ACCU-PAK® BOX

## Storage & Handling

### GENERAL INFORMATION

Never tip or roll an Accu-Pak® box – box shall be kept vertical at all times.

### LIFTING STRAP INSTRUCTIONS

(The following instructions are in no way intended to supersede the manufacturers' instructions for the use of their lifting device)

1. Place the wooden master pallet on the floor.
2. Remove all stretch wrap and/or tape binding the boxes together.
3. Prior to lifting, inspect the box for dents, gashes or holes penetrating the side of the box, and dented or crushed box lids. **NEVER LIFT DAMAGED BOXES.**
4. Remove the strap loops from the slots on the box lid.
5. Confirm the two strap loops are from the same box.
6. Do not remove the lid while moving the box.
7. For 500 lb & 1000 lb Accu-Pak boxes, the straps may be placed directly on the tow motor. Configure the straps according to the pictures below for proper use. Straps should come up vertically. For 1500 lb Accu-Pak boxes, a lifting device must be used. For all boxes, if a lifting device is used, follow the manufacturer's instructions to assure proper handling.



8. Lift the box straight up off the wooden master pallet. **DO NOT LIFT AT AN ANGLE.**
9. Avoid sudden starts and stops.
10. When using an overhead crane, use standard safety procedures.
11. Once the Accu-Pak box has been placed at its point of use, follow the instructions inside the center of the box for proper set up.

### MINI PALLET INSTRUCTIONS

1. Follow the first 3 steps listed for lifting with straps.
2. Extend the tow motor forks to completely reach through the mini pallet to ensure the box does not tip or fall over. Verify that the mini pallet and Accu-Pak box are secure and are 100% in contact with the tow motor.
3. Then proceed to lift and place the box at its intended location.



### ⚠ CAUTION ⚠

1. Boxes should never be lifted to a height greater than necessary – when moving boxes, while in the air, the box can start swinging resulting in injury.
2. Appropriate care should be taken to avoid pinch points when moving the box.
3. Appropriate personal safety equipment should be worn to prevent injury such as a safety helmet to prevent head injury.
4. When lifting a box, care should be given to the path the box will take in getting to its intended location as to avoid collision with other items.
5. Do not walk under the box while it is in the air and never move the box over others.
6. Only qualified material handling personnel should attempt lifting or handling the Accu-Pak box.
7. Lincoln Electric is not responsible for consequential damage due to improper lifting or movement of box.

# ACCU-TRAK® DRUM & SPEED-FEED® DRUM

## Storage & Handling

### GENERAL INFORMATION

Never tip or roll an Accu-Trak® or Speed-Feed® drum – drum shall be kept vertical at all times.

Only use appropriate lifting devices designed for lifting fiber drums with steel chimes, within manufacturers' ratings while adhering to manufacturers' instructions.

### LIFTING WITH A DRUM LIFTING DEVICE

(The following instructions are in no way intended to supersede the manufacturers' instructions for the use of their lifting device)

1. Place the wooden master pallet on the floor.
2. Remove shrink-wrap, cut and remove the band that secures all four drums together.
3. After removing the shrink-wrap from the perimeter of the pallet of drums, the banding that wraps around the top chime of the drum, tying the drums together, should be removed.
4. The band, which secures the drum to the mini pallet, may also be removed (optional).
5. Prior to lifting, inspect the drum for dents, gashes or holes penetrating the side of the drum, and dented or crushed drum lids or chimes. Verify the drum is closed and the chimes are in the locked position. **NEVER LIFT A DAMAGED OR OPEN DRUM.**
6. After inspection, the grippers of drum lifting device should be placed in the groove of the top chime. Placing the gripper of one side of the lifting device in the center of the drum pallet and catching the mating groove in the top chime makes the effort easier.
7. The device can then be opened and placed in the groove, 180 degrees from the starting point. After verifying that the grippers on both sides of the lifting device are properly secured and are in 100% contact with the groove in the top drum chime, lifting of the drum can proceed.
8. Place the drum at its intended location and remove the lifting device.

### 250-600 LB ACCU-TRAK DRUMS AND SPEED-FEED DRUMS

The 500 lb. drums come standard four drums per pallet. These drums are placed directly on the surface of the pallet.

### 1000 LB OR > ACCU-TRAK DRUMS & SPEED-FEED DRUMS

The 1000 lb. drums come standard four drums per pallet. Each drum is placed on an individual mini pallet then mounted on a master pallet. The mini-pallet is used to facilitate the moving of these drums with a standard tow motor.



### ⚠ CAUTION ⚠

1. Drums should never be lifted to a height greater than necessary – when moving drums, while in the air, the drum can start swinging resulting in injury
2. Appropriate care should be taken to avoid pinch points when moving the drum
3. Appropriate personal safety equipment should be worn to prevent injury such as a safety helmet to prevent head injury
4. When lifting a drum, care should be given to the path the drum will take in getting to its intended location as to avoid collision with other items
5. Do not walk under the drum while it is in the air and never move the drum over others
6. Only qualified material handling personnel should attempt lifting or handling the Accu-Trak and Speed-Feed drums
7. Lincoln Electric is not responsible for consequential damage due to improper lifting or movement of drums



CONSUMABLES  
**APPENDIX**

*AWS Classification System*

Stick (SMAW) .....	M-1
MIG (GMAW), TIG (GTAW) & Metal-Cored (GMAW-C) .....	M-2
Flux-Cored (FCAW) .....	M-3
Submerged Arc (SAW) Flux & Electrode .....	M-6

*General Information*

**Stick Electrode**

Types of Coating & Current .....	M-8
ASME Boiler & Pressure Vessel Code .....	M-9

**Submerged Arc**

Flux Types & General Characteristics .....	M-10
Selecting Flux/Wire Combinations .....	M-11

**Innershield®**

Wire Selection Guide .....	M-13
----------------------------	------

**Hardfacing**

Cross Checking .....	M-15
----------------------	------

<i>Agency Approvals</i> .....	M-16
-------------------------------	------

<i>Safety Guidelines</i> .....	M-37
--------------------------------	------

# AWS CLASSIFICATION SYSTEM

Stick (SMAW)

*Mild & Low Alloy Steel per AWS A5.1/A5.1M and AWS A5.5/A5.5M*

## CLASSIFICATION DESIGNATORS PER AWS A5.1 & A5.5

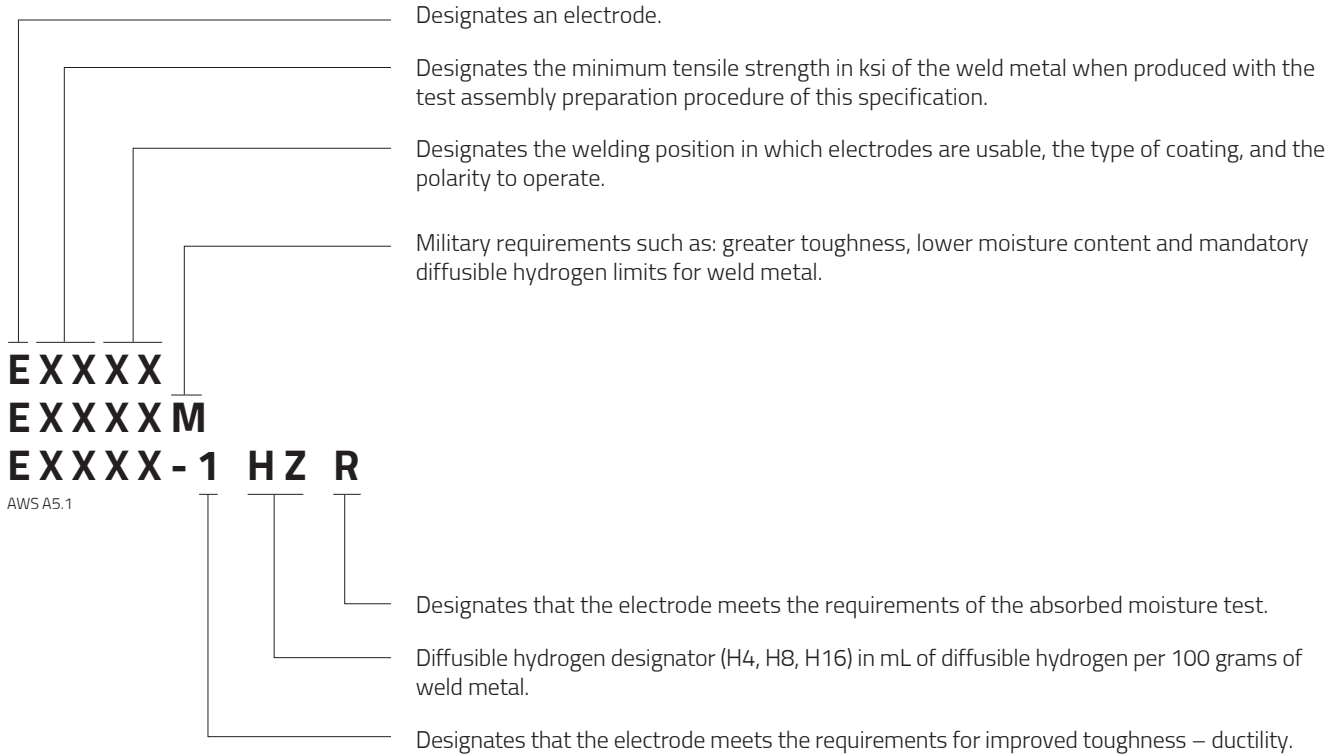

## CLASSIFICATION DESIGNATORS PER AWS A5.5 ONLY

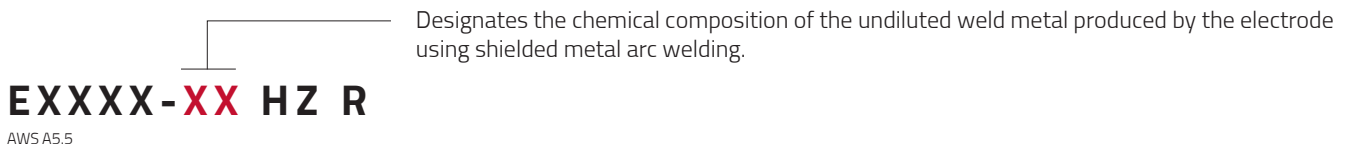

## ADDITIONAL CLASSIFICATIONS

### Stainless Steel - Per AWS A5.4

E XXX - 15

The three digits that follow the "E" indicate the American Iron and Steel Institute type of stainless steel. The last two digits indicate the current and the welding position in which it is used:

- 15 fast freezing slag for out-of-position welding
- 16 stable arc and out-of-position welding capability
- 17 smooth arc transfer in the flat and horizontal welding positions.

# AWS CLASSIFICATION SYSTEM

MIG (GMAW), TIG (GTAW) & Metal-Cored (GMAW-C)

*Mild & Low Alloy Steel per AWS A5.18/A5.18M and AWS A5.28/A5.28M*

## CLASSIFICATION DESIGNATORS PER AWS A5.18 & A5.28

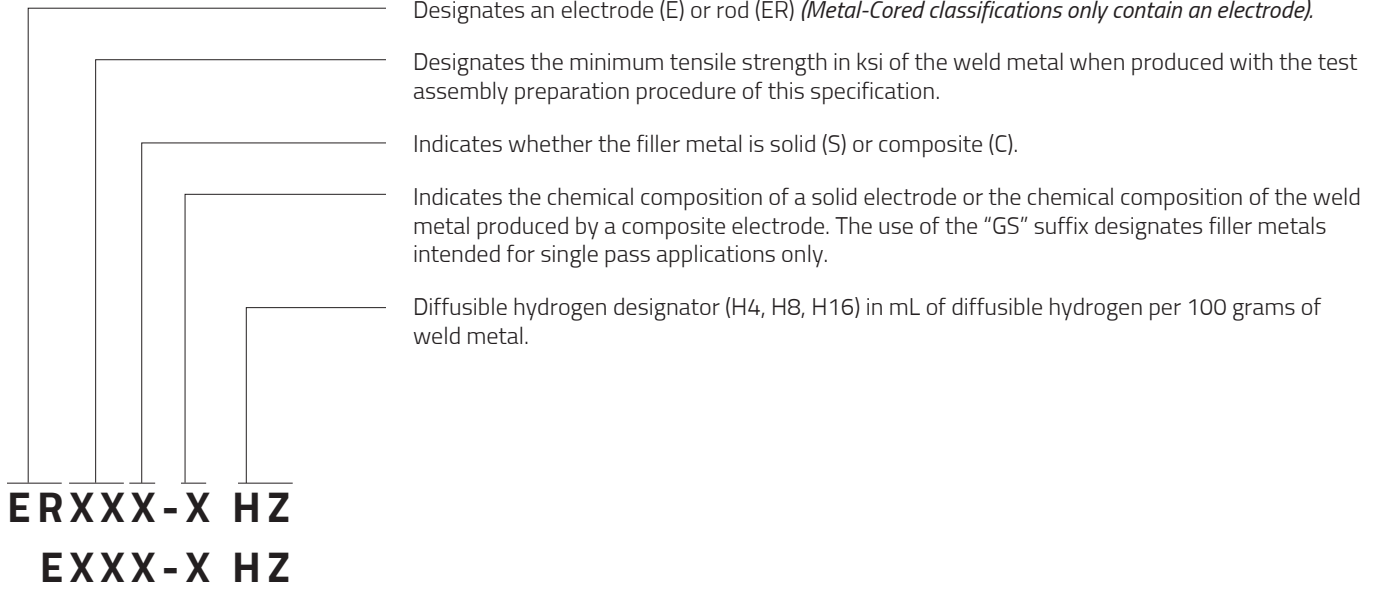

## ADDITIONAL CLASSIFICATIONS

### Aluminum – Per AWS A5.10/A5.10M

ERXXXX

The first digit following "E" or "ER" indicates the principle alloying element or elements (4 – Silicon, 5 – Magnesium). If the second digit following "E" or "ER" is different from zero, it denotes a modification to the original alloy. The last two digits are used to identify the specific alloy.

### Stainless – Per AWS A5.9/A5.9M

ERXXXLSi

The three digits following "E" or "ER" specify the chemical composition of the filler metal with a series of numbers. In some cases, chemical symbols for the letter L (low carbon), Si (high silicon), or H (high carbon) will follow to designate modifications of basic alloy types.

### Nickel Alloy – Per AWS A5.14/A5.14M

ERXXXX-X

The chemical symbol "Ni" appears in the designations immediately after "E" or "ER" to identify the filler metal as a nickel-based alloy. Other symbols such as Cr and Mo in the designation are intended to group the filler metals according to their principal alloying elements. The number at the end of the designation separates one composition from another within a group.

# AWS CLASSIFICATION SYSTEM

## Flux-Cored (FCAW)

*Mild & Low Alloy Steel per AWS A5.20/A5.20M and AWS A5.29/A5.29M*

### CLASSIFICATION DESIGNATORS PER AWS A5.20 & A5.29

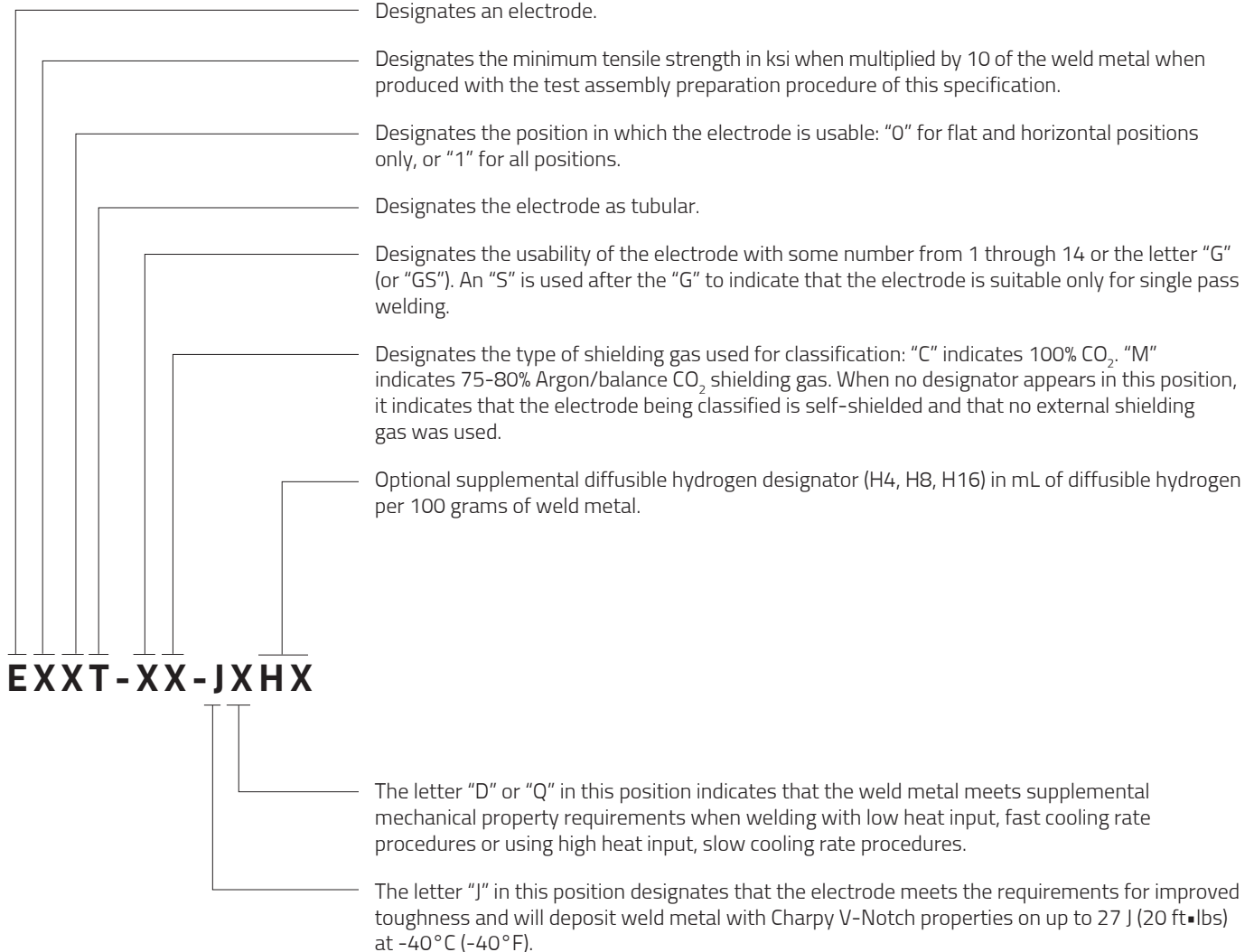

# AWS CLASSIFICATION SYSTEM

## Flux-Cored (FCAW)

*Mild & Low Alloy Steel per AWS A5.20/A5.20M and AWS A5.29/A5.29M*

### CLASSIFICATION DESIGNATORS PER AWS A5.29 ONLY

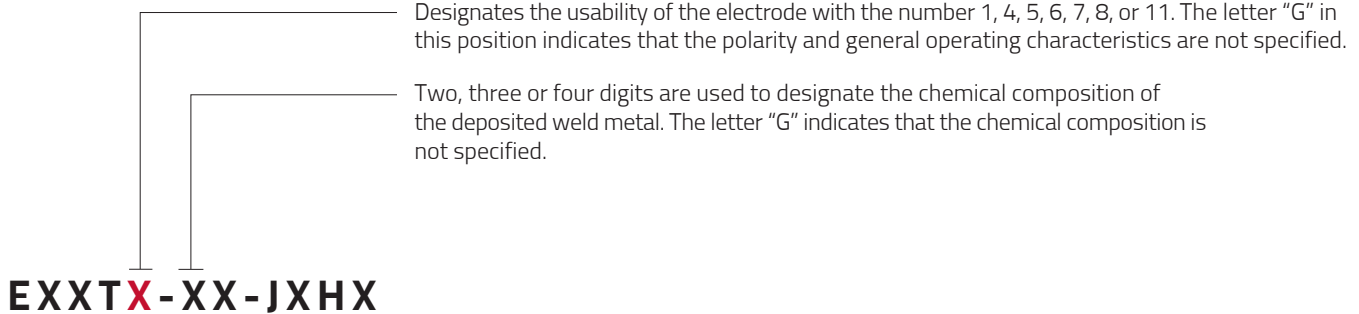

### ADDITIONAL CLASSIFICATIONS

#### Stainless Steel - Per AWS A5.22/A5.22M

EXXTX-X

The three digits that follow "E" designate the chemical composition of the weld metal. The digit following "T" designates the position in which the electrode is usable: "0" for flat and horizontal positions only, or "1" for all positions.



# AWS CLASSIFICATION SYSTEM

## Flux-Cored (FCAW)

### Mild & Low Alloy Steel per AWS A5.36/A5.36M

#### CLASSIFICATION DESIGNATORS PER AWS A5.36



# AWS CLASSIFICATION SYSTEM

## Submerged Arc (SAW) Flux & Electrode

### *Classification Descriptions for AWS A5.17 & A5.23*

The electrode classification identifies the chemical composition of the electrode. The following paragraphs highlight the differences between these electrodes and electrode groups and indicate typical applications.

#### **MILD STEEL ELECTRODES**

##### **EL8, EL8K, EL12, EM11K, EM12, EM12K, EM13K, EM14K, EM15K, EH10K, EH11K, EH12K and EH14**

Carbon steel electrodes which vary from one another in their carbon, manganese, and silicon contents. EM14K electrodes also contain small additions of titanium, although they are considered carbon steel electrodes.

#### **LOW ALLOY ELECTRODES**

##### **EA1, EA2, EA3, EA3K, and EA4 (C-Mo Steel)**

Similar to the medium manganese and high manganese carbon steel electrodes shown above except that 0.5% molybdenum is added.

**EB1, EB2, EB2H, EB3, EB5, EB6, EB6H, EB8, and EB9 (Cr-Mo Steel)** – Produce weld metal containing between 0.5% and 10% chromium and between 0.5% and 1% molybdenum.

The letter “R” when added as a suffix to the EB2 or EB3 electrode classification or to the B2 or B3 weld metal designation is an optional supplemental designator indicating that the electrode will meet the reduced residual limits necessary to meet “X” factor requirements for step cooling applications.

Since all Cr-Mo weld deposits will air harden in still air, both preheat and postweld heat treatment (PWHT) are required for most applications.

EB9 is a 9% Cr-1% Mo electrode modified with niobium (columbium) and vanadium designed to provide improved creep strength, and oxidation and corrosion resistance at elevated temperatures.

**ENi1, ENi1K, ENi2, and ENi3 (Ni Steel)** – Designed to produce weld metal with increased strength without being hardenable or with increased notch toughness at temperatures as low as -100°F (-73°C) or lower. They have been specified with nickel contents which fall into three nominal levels of 1% Ni, 2.5% Ni, and 3.5% Ni.

**ENi4, ENi5, EFi, EF2, and EF3 (Ni-Mo Steel)** – Contain between 0.5% and 2% nickel and between 0.25% and 0.5% molybdenum.

**EF4, EF5, and EF6 (Cr-Ni-Mo Steel)** – A combination of Cr, Ni, and Mo develop the strength levels and notch toughness required for a number of high-strength, low-alloy or micro-alloyed structural steels.

**EM2, EM3, and EM4 (High-Strength, Low Alloy Steel)** – May contain a combination of Cr, Ni, Mo, Ti, Zr and Al.

**EW (Weathering Steel)** – Designed to produce weld metal that matches the corrosion resistance and the coloring of the ASTM weathering-type structural steels. These special properties are achieved by the addition of about 0.5% copper to the weld metal.

**EG (General Low-Alloy Steel)** – Indicates that the electrode is of a general classification. It is general because not all of the particular requirements specified for each of the other classifications are specified for this classification.

# AWS CLASSIFICATION SYSTEM

## Submerged Arc (SAW) Flux & Electrode

*Mild & Low Alloy Steel - Per AWS A5.17/A5.17M and AWS A5.23/A5.23M*

### CLASSIFICATION DESIGNATORS PER AWS A5.17 & A5.23

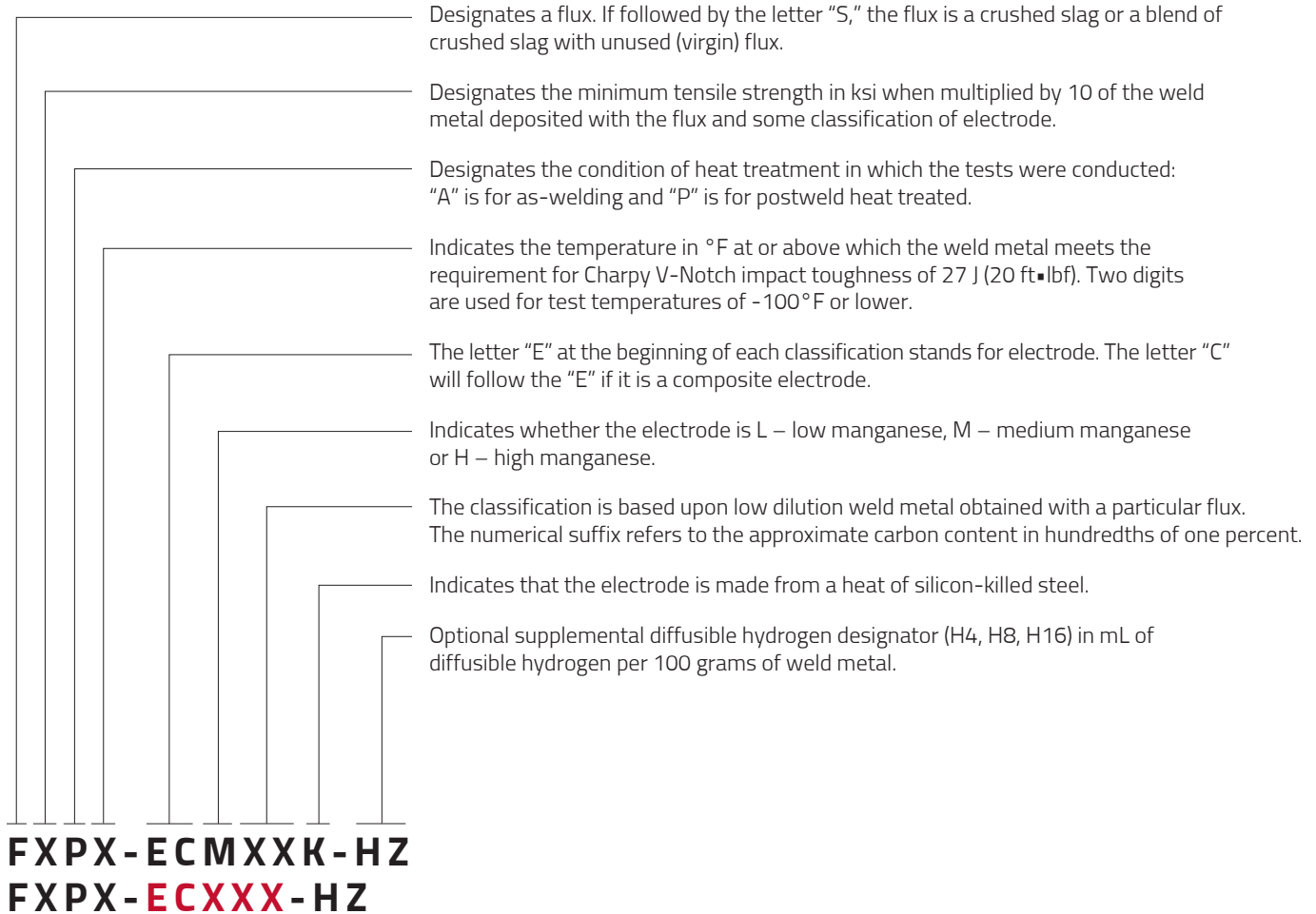

### CLASSIFICATION DESIGNATORS PER AWS A5.23 ONLY

Indicates the chemical composition of a solid electrode or the undiluted weld metal obtained with a composite electrode and particular flux. Usually a combination of letters, numbers and elements (see next page).

#### MILD STEEL EXAMPLES

F7A6-EM12K is a complete designation for a flux-electrode combination. It refers to a flux that will produce weld metal which, in the as-welded condition, will have a tensile strength of 70,000 to 95,000 psi and Charpy V-Notch impact strength of at least 20 ft•lbf at -60°F when produced with an EM12K electrode under the conditions called for in this specification. The absence of an "S" in the second position indicates that the flux being used is a virgin flux. F7P4-EC1 is a complete designation for a flux-composite electrode combination when the trade name of the electrode used in the classification is indicated as well. It refers to a virgin flux that will produce weld metal with that electrode which, in the postweld heat treated condition, will have a tensile strength of 70,000 to 95,000 psi and Charpy V-Notch energy of at least 20 ft•lbf at -40°F under the conditions called for in this specification.

#### LOW ALLOY STEEL EXAMPLES

F9P0-EB3-B3 is a complete designation for a flux-electrode combination. It refers to a flux that will produce weld metal which, in the postweld heat treated condition, will have a tensile strength of 90,000 to 110,000 psi and Charpy V-Notch impact strength of at least 20 ft•lbf at 0°F when produced with an EB3 electrode under the conditions called for in this specification. The composition of the weld metal will meet the requirements for a B3 designation.

# STICK ELECTRODE

## Types of Coating & Current

### MILD STEEL PER AWS A5.1

#### TYPES OF COATING & CURRENT

Digit	Types of Coating	Current
0	High cellulose sodium	DC+
1	High cellulose potassium	AC, DC±
2	High titania sodium	AC, DC-
3	High titania potassium	AC, DC+
4	Iron powder, titania	AC, DC±
5	Low-hydrogen sodium	DC+
6	Low-hydrogen potassium	AC, DC+
7	High iron oxide, iron powder	AC, DC±
8	Low-hydrogen potassium, iron powder	AC, DC±

### LOW ALLOY STEEL PER AWS A5.5

#### TYPES OF COATING

Suffix	%C	%Mn	%Si	%P	%S	%Ni	%Cr	%Mo	%V
A1	0.12	0.60	0.40	0.03	0.03			0.40 - 0.65	
B2	0.05 - 0.12	0.90	0.80	0.03	0.03		1.00 - 1.50	0.40 - 0.65	
B3	0.05 - 0.12	0.90	0.80	0.03	0.03		2.00 - 2.50	0.90 - 1.20	
C1	0.12	1.25	0.80	0.03	0.03	2.00 - 2.75			
C3	0.12	0.40 - 1.25	0.80	0.03	0.03	0.80 - 1.10	0.15	0.35	0.05
D2	0.15	1.65 - 2.00	0.80	0.03	0.03	0.90		0.25 - 0.45	
G <sup>(1)</sup>		1.00 min	0.80 min	0.03	0.03	0.50 min	0.30 min	0.20 min	0.10 min
P1	0.20	1.20	0.60	0.03	0.03	1.00	0.30	0.50	0.10
P2	0.12	0.90 - 1.70	0.80	0.03	0.03	1.00	0.30	0.50	0.05

<sup>(1)</sup> Only one of the listed elements is required.

#### NOTE 1: Joining Electrodes, Non-Charpy V-Notch Rated

These electrodes (see below) and others of the same AWS classification, are not required to deposit weld metal capable of delivering any minimum specified Charpy V-Notch (CVN) properties. It should not be used in applications where minimum specified CVN properties are required. Typical applications where minimum specified CVN properties are required include, but are not restricted to, bridges, pressure vessels, and buildings in seismic zones. The user of this product is responsible for determining whether minimum CVN properties are required for the specific application.

Fleetweld® 22    Fleetweld® 37    Fleetweld® 47

#### NOTE 2: Joining Electrodes, Non-Low Hydrogen

These electrodes (see below) and others of the same AWS classification, are not required to deposit weld metal that is low in diffusible hydrogen. Therefore, these electrodes should not be used in applications where the hydrogen content of the weld metal is required to be controlled, such as applications that involve steels with higher carbon and alloy content, and higher strength.

Fleetweld® 5P    Fleetweld® 35LS    Fleetweld® 22    Shield-Arc® HYP+    Jetweld® 2    Pipeliner® 7P+  
 Fleetweld® 5P+    Fleetweld® 180    Shield-Arc® 85    Fleetweld® 47    Shield-Arc® 70+    Piperliner® 8P+  
 Fleetweld® 35    Fleetweld® 37    Shield-Arc® 90    Jetweld® 1    Pipeliner® 6P+

# STICK ELECTRODE

ASME Boiler &amp; Pressure Vessel Code

## ASME BOILER & PRESSURE VESSEL CODE

Section IX - F and A No.'s for Stick Electrode			
F Number (per ASME Section IX and AWS D1.1)	AWS Classifications	Product	Weld Metal Analysis Classification (per ASME Section IX)
F-1	EXX20, EXX24, EXX27, EXX28, EXX20-X, EXX27-X	Fleetweld® 22 Jetweld® 2 Jetweld® 1 Excalibur® 7028	– A1 A1 A1
F-2	EXX12, EXX13, EXX14, EXX13-X	Fleetweld® 37 Fleetweld® 47	A1 A1
F-3	EXX10, EXX11, EXX10-X, EXX11-X	Fleetweld® 5P Fleetweld® 5P+ Pipelinor® 6P+ Fleetweld® 35 Fleetweld® 35LS Fleetweld® 180 Shield-Arc® 85 Shield-Arc® 70+ Shield-Arc® 90 Shield-Arc® HYP+ Pipelinor® 7P+ Pipelinor® 8P+	A1 A1 A1 A1 A1 A1 A2 – A11 – – –
F-4	EXX15, EXX16, EXX18, EXX45-X, EXX15-X, EXX16-X, EXX18-X	Jetweld® LH-70 Jet-LH® 78 Lincoln® 7018AC Excalibur® 7018 MR Excalibur® 7018-1 MR Excalibur® 7018-A1 MR Excalibur® 8018-B2 MR Excalibur® 8018-C1 MR Excalibur® 8018-C3 MR Excalibur® 9018-B3 MR Excalibur® 9018M MR Excalibur® 10018-D2 MR Excalibur® 11018M MR Pipelinor® 16P Pipelinor® 18P Pipelinor® 19P Pipelinor® LH-D80 Pipelinor® LH-D90 Pipelinor® LH-D100	A1 A1 A1 A1 A1 A2 A3 A10 A10 A4 A10 A11 – A1 A10 A10 A1 – –

# SUBMERGED ARC FLUXES

## Flux Types and General Characteristics

The Lincoln Electric Company manufactures three general types of submerged arc fluxes:

- *Active fluxes*
- *Neutral fluxes*
- *Alloy fluxes*

With all submerged arc fluxes, variations in arc voltage change flux consumption. Higher arc voltages and the resulting longer arc length increase the amount of flux melted or consumed. Consequently, when a flux contains an alloy as an ingredient, increasing the arc voltage increases the amount of alloy recovered in the weld deposit.

### *Types and General Characteristics*

#### **ACTIVE FLUXES**

American Welding Society (AWS) defines active fluxes as those which contain small amounts of manganese, silicon, or both. These deoxidizers are added to the flux to provide improved resistance to porosity and weld cracking caused by contaminants on or in the base metal.

The primary use for active fluxes is to make single pass welds, especially on oxidized base metal.

Alloy in the weld deposit will vary with changes in the arc voltage. An increase in deposit alloy increases the strength level of the weld metal, but might lower the impact properties. For this reason, voltage must be more tightly controlled for multiple pass welding with active fluxes than when using neutral fluxes. Because of this, Lincoln Electric does not recommend using active fluxes (our 700 series) for multiple pass welding of plates over 25 mm (1 in) thick.

#### **NEUTRAL FLUXES**

AWS defines neutral fluxes as those which will not produce any significant change in the all-weld metal composition as a result of a large change in the arc voltage, and thus, the arc length.

Neutral fluxes are used in multiple pass welding, especially when the base plate exceeds 25 mm (1 in) in thickness. They are also used for general welding on clean steel. Note the following considerations concerning neutral fluxes:

1. Since neutral fluxes contain little or no alloy, they have little resistance to cracking and/or porosity caused by contaminants, especially on single pass welds. For this reason, active fluxes are usually the best choice for single pass welding.
2. Even when a neutral flux is used to maintain the weld metal composition through a range of welding voltage, weld properties, such as strength level and impact properties, can change because of changes in cooling rate, penetration, heat input and number of passes.

#### **ALLOY FLUXES**

AWS defines alloy fluxes as those which can be used with a plain carbon steel electrode to make an alloy weld deposit. The alloys for the weld deposit are added as ingredients in flux.

The primary use of alloy fluxes is hardfacing applications.

Since the alloy level in the weld deposit is dependent upon the correct arc voltage, and thus arc length, it is very important that the voltage is carefully controlled to ensure that the intended alloy is reached in the deposit.

# SUBMERGED ARC FLUX/WIRE

## Selecting Flux/Wire Combinations

### *Guidelines for Selecting a Submerged Arc Flux/Wire Combination*

Lincolnweld® submerged arc electrode and flux combinations come with certificates of conformance. To access these certificates, follow the directions below.

1. Go to the Lincoln Electric home page at [www.lincolnelectric.com](http://www.lincolnelectric.com).
2. Click on the 'Support' tab and select 'Certificate Center' from the drop down. (Image 1)
3. Under 'Certificates of Conformance,' you can choose a Product or a Flux Combination. This will bring up the most recent Certificate of Conformance. (Image 2)

### *How to look for flux/wire combinations that meet your required mechanical properties:*

#### **TENSILE STRENGTH**

1. In the second box under 'Certificates of Conformance,' you can 'Search by Name/ Cert # / Classification.'
2. Enter F#P or F#A. Where # is 10X the required Tensile Strength in ksi. P= Stress Relieved, A= As-Welded.
  - a. *For example, entering F7P would mean you are looking for a flux/wire combination with 70 ksi Tensile Strength in the Stress Relieved Condition.*

#### **IMPACT REQUIREMENTS**

1. In the list of matches for your required Tensile Strength, you can see which Flux/Wire Combinations also meet your Impact Property Requirements.
2. If you need to meet Impact Requirements at a certain value, note that the digit following the "A" or "P" in the classifications shows the temperature at which the weld metal achieves a minimum of 27 J (20 ft•lbf).
  - a. *For example, a classification beginning with F7P2 would mean that the flux/wire combination meets 70 ksi Tensile Strength in the Stress Relieved Condition and Impact Requirements of 27 J (20 ft•lbf) @ -29°C (-20°F).*

In general, if you are familiar with one of the listed fluxes, you might want to choose that option. From an operator's standpoint, it is easier to change electrodes than to reset procedures for a new flux.

If you are welding high strength or highly restrained steel, you might want to choose a Flux/Wire Combination with a lower diffusible hydrogen level, which is designated by the number following -H in the flux/wire classification.

If you have limits on the compositions of the electrode or the weld metal, click on a Flux/Wire Combination to see the test results. Remember that these results represent undiluted weld metal from a standardized test and may be different from your application, especially if variations in base metal, heat input or pass sequence are present.

Your Lincoln Electric Technical Sales Representatives are there to help you make the best flux/wire selection for your application. Please contact them with any questions.

# SUBMERGED ARC FLUX/WIRE

## Selecting Flux/Wire Combinations

### Guidelines for Selecting a Submerged Arc Flux/Wire Combination

**Image 1:**

At the Lincoln Electric home page select "Certificate Center" from the drop down menu under the "Support" tab.

**Image 2:**

At the Certificate Center, enter a product name or search by Name, Cert #, or Classification. Search results will appear below.



Image 1

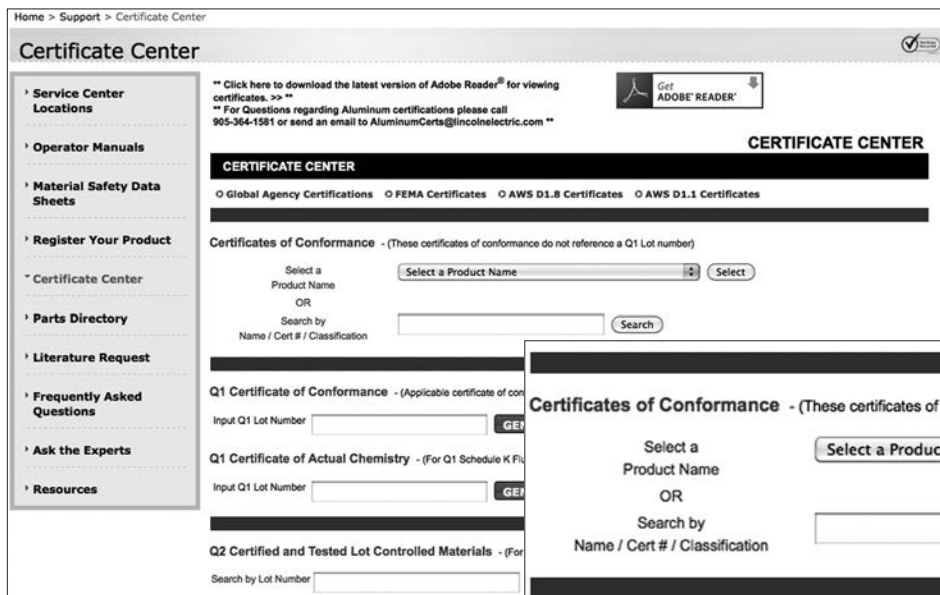
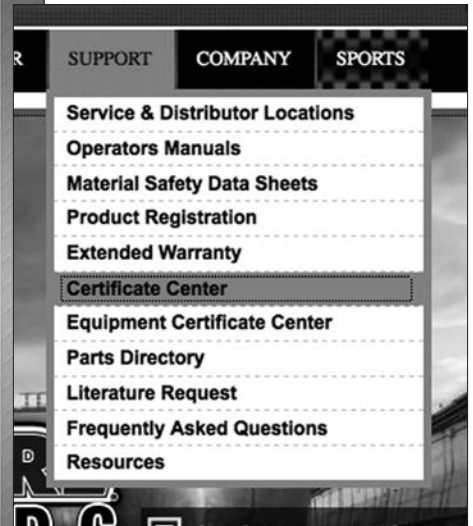

Image 2



# INNERSHIELD®

## Wire Selection Guide

### POSITION OF WELDING, POLARITY AND APPLICATION REQUIREMENTS

AWS Classifications	Welding Position <sup>(1)</sup>	Current	Application <sup>(2)</sup>
E70T-3	H and F	DC+	S
E70T-4	H and F	DC+	M
E70T-6	H and F	DC+	M
E70T-7	H and F	DC-	M
E71T-8	H, F, VU, OH	DC-	M
E70T-10	H and F	DC-	S
E71T-11	H, F, VD, OH	DC-	M
E71T-14	H, F, VD, OH	DC-	S
E71T-G	VU, OH	Not Specified	M

<sup>(1)</sup> H = Horizontal position  
F = Flat position

OH = Overhead position  
VU = Vertical-Up position

VD = Vertical-Down position  
<sup>(2)</sup> S = Single pass only

M = Single or Multiple pass

### FOR EVERYTHING YOU NEED TO KNOW ABOUT WELDING IN SEISMIC ZONES

To assist structural fabricators, erectors, inspectors and specifying engineers, Lincoln Electric created this D1.8 Resource Center with tools to understand seismic welding guidelines and links to Lincoln Electric consumables tested to meet the AWS D1.8 and

FEMA 353 requirements. The development of Lincoln Electric's D1.8 Resource Center is just one more way Lincoln sets the standard for the welding industry, worldwide.



[www.lincolnelectric.com/LEExtranet/MyLincolnCerts/site/awsd.aspx](http://www.lincolnelectric.com/LEExtranet/MyLincolnCerts/site/awsd.aspx)

# INNERSHIELD®

## Wire Selection Guide

### LOW TEMPERATURE IMPACT PROPERTIES

Name	AWS Classifications	Diameter in (mm)
<b>All Position</b>		
NR®-203MP	E71T-8J	0.068 (1.7) 5/64 (2.0)
NR®-203 Nickel (1%)	E71T8-Ni1	5/64 (2.0)
NR®-440Ni2	E71T8-Ni2-JH8	5/64 (2.0)
NR®-203 Ni C Plus H	E71T8-K2	5/64 (2.0)
NR®-232	E71T-8	0.068 (1.7) 0.072 (1.8) 5/64 (2.0)
NR®-233	E71T-8	1/16 (1.6) 0.072 (1.8) 5/64 (2.0)
<b>Flat and Horizontal</b>		
NR®-305	E70T-6	5/64 (2.0) 3/32 (2.4)
NR®-311 Ni	E70T-7-K2	5/64 (2.0) 3/32 (2.4) 7/64 (2.8)
NR®-FAB-70	E70T7-G	3/32 (2.4)

### HIGH DEPOSITION WITH NO LOW TEMPERATURE IMPACT PROPERTIES

Name	AWS Classifications	Diameter in (mm)
<b>Flat and Horizontal</b>		
NR®-311	E70T-7	5/64 (2.0) 3/32 (2.4) 7/64 (2.8)
NS-3M	E70T-4	5/64 (2.0) 3/32 (2.4) 0.120 (2.8)

### PIPE FABRICATION

Name	AWS Classifications	Diameter in (mm)
<b>All Position</b>		
NR®-207	E71T8-K6	0.068 (1.7) 5/64 (2.0)
NR®-208-H	E91T8-G-H8	5/64 (2.0)
<i>Pipeliners®</i>		
<b>All Position</b>		
NR®-208-XP	E81T8-G	5/64 (2.0)
NR®-207+	E71T-8-K6	5/64 (2.0)

### FEMA 353 AND AWS D1.8 COMPLIANT

Name	AWS Classifications	Diameter in (mm)
<b>Flat and Horizontal</b>		
NR®-311 Ni	E70T-7-K2	3/32 (2.4)
NR®-FAB-70	E70T7-G	3/32 (2.4)
NR®-305	E70T-6	5/64 (2.0) 3/32 (2.4)
<b>All Position</b>		
NR®-232	E71T-8	0.068 (1.7) 0.072 (1.8) 5/64 (2.0)
NR®-233	E71T-8	1/16 (1.6) 0.072 (1.8) 5/64 (2.0)

### SINGLE PASS ONLY WITH NO LOW TEMPERATURE IMPACT PROPERTIES

Name	AWS Classifications	Diameter in (mm)
<b>Flat and Horizontal</b>		
NR®-5	E70T-3	3/32 (2.4) 0.0120 (3.0)
NR®-131	E70T-10	3/32 (2.4)
NR®-152	E71T-14	1/16 (1.6) 0.068 (1.7)

### GENERAL FABRICATION WITH NO LOW TEMPERATURE IMPACT PROPERTIES

Name	AWS Classifications	Diameter in (mm)
<b>All Position</b>		
NR®-211-MP	E71T-11	0.030 (0.8) 0.035 (0.9) 0.045 (1.1) 0.068 (1.7) 5/64 (2.0) 3/32 (2.4)
NR®-212	E71TG-G	0.045 (1.1) 0.068 (1.7) 5/64 (2.0)

# HARDFACING

## Cross Checking

Special precautions should be taken with any build-up or hardfacing product on applications that are inherently crack sensitive, such as high carbon or alloy steels, previously hardfaced parts, highly stressed parts, and work hardened parts. The hardfacing of heavy cylinders, massive parts and parts having complex shapes are all examples of applications exhibiting high internal stresses that may result in delayed cracking.

These applications may require one or more of the following:

- Higher preheat temperatures
- Higher interpass temperatures
- Controlled slow cooling between passes and/or layers
- Stress relieving
- Minimizing layer thickness

The table below will help determine if special precautions need to be taken with specific Lincore® wires:

### SPECIAL PRECAUTIONS

Product	Lincore® Products								
	55	55-G	65-0	60-0	30-S	32-S	35-S	40-S	42-S
<b>Higher Preheat Temp.<sup>(1)</sup></b> 150 °C - 260°C (300 °F - 500°F) 200 °C - 260°C (400 °F - 500°F)	✓	✓	✓	✓					
					✓	✓	✓	✓	✓
<b>Higher Interpass Temp.</b> 200 °C - 320°C (400 °F-600°F)	✓	✓	✓	✓	✓	✓	✓	✓	✓
<b>Controlled Cooling Between Passes/Layers</b>	✓	✓	✓	✓	✓	✓	✓	✓	✓
<b>Stress Relieving 430°C - 480°C (800°F - 900°F)<sup>(2)</sup></b> Every 6.4 mm (1/4 in) Thickness of Deposit Every 10-13 mm (3/8 - 1/2 in) Thickness of Deposit	✓	✓							
			✓	✓	✓				
<b>Minimize Layer Thickness</b>			✓		✓	✓	✓	✓	✓

<sup>(1)</sup>Preheat depends on the base material chemistry and thickness, as well as the weld metal chemistry.

<sup>(2)</sup>Stress relieving in temperatures in excess of 482 °C (900 °F) will result in a "softening" of the deposit.

# AGENCY APPROVALS

## Consumables Qualifications Guide

The notes and codes listed below are also repeated throughout the catalog where applicable.

- **American Bureau of Shipping (ABS)** approvals are issued subject to the Bureau's Rule requirement for Materials and Welding Part 2. Tests are conducted in the company's plant, under supervision of an ABS surveyor to determine if electrodes conform to ABS grades or AWS specifications previously judged satisfactory by ABS for welding vessels. The Bureau publishes a list of approved electrodes giving their class and approved operating positions for each size. Sometimes, where there is no approved specification, approval may be given on the basis that each individual shipyard or contractor will qualify the procedure and electrode subject to Part 2, Section 3, paragraph 2/3C.3.2.c.
- **American Society of Mechanical Engineers (ASME)** has issued specifications covering construction of nuclear facilities. Each lot of welding consumables to be used must be individually tested to ASME SFA specifications.
- **American Welding Society (AWS)** specifications and classifications are established by the Society to provide standards for different types of electrodes throughout the industry. AWS does not test or approve any electrodes. The manufacturer certifies that their electrode conforms to a certain class.
- **Canadian Welding Bureau (CWB)** approvals are based on tests witnessed by a CWB representative. Approvals listed in this booklet are for products manufactured in the USA. Products manufactured in Canada are approved separately. In general, CWB specifications are similar to AWS specifications. Copies of approvals are maintained in Cleveland and are available upon request.
- **Lloyd's Register (LR), Det Norske Veritas (DNV), Germanischer Lloyd (GL), Bureau Veritas (BV), Controlas, and Nippon Kaiji Kyokai (NKK)** issue approvals for electrodes used worldwide in shipbuilding, offshore structures and pressure vessels. Products approved under the rules of these classification societies require annual requalification under the supervision of their surveyors.
- **TÜV (TUV)** is a German agency very similar to ASME. Projects manufactured under TÜV rules must be welded with consumable approved by TÜV. Initial approvals are obtained based on testing completed under TÜV supervision. Approvals are maintained subject to Quality Assurance audits completed every two years.
- **Deutsche Bahn (DB)** is the approval agency for German railroads. Approvals are based on tests specified by DB, and witnessed by an authorized third party.

# AGENCY APPROVALS

NOTE: Approvals are updated periodically.

*Consult your Lincoln Electric representative for the latest Approval/Grade revisions.*

Product	AWS A5	ABS	CWB/CSA	DNV	Lloyd's Register	BV	AWS D1.8	ISO	JIS	TUV
<b>FCAW-G</b>										
Outersield 71 Elite	E71T1-C1A2-CS1-H8, E71T1-M21A2-CS1-H8, E71T-1C-H8, E71T-1M-H8, E71T-9C-H8, E71T-9M-H8	3YSA H10	E491T-9-H8, E491T-9M-H8	III YMS H10	3YS H10		0.052", 1/16"			
Outersield 71 Supreme	E71T-1C-H4, E71T-1M-H4, E71T-9C-H4, E71T-9M-H4									
Outersield 71M	E71T1-C1A4-CS1-H16, E71T1-M21A4-CS1-H16, E71T-1C-JH16, E71T-1M-JH16, E71T-9C-JH16, E71T-9M-JH16	3YSA H15	E491T1-C1A4-CS1-H16, E491T1-M21A4-CS1-H16, E491T-9J-H16, E491T-9MJ-H16	III YMS H10	3YS H15	SA3YH		T49 4 T1-1 C1 A H15 T49 4 T1-1 M21 A H15		
Outersield XLH70	E70T1-C1A2-CS1-H8, E70T-1C-H8, E70T-9C-H8	3YSA H5					3/32"			
Pipeliners 101M	E101T1-M21A4-K11, E101T1-GM							T 62 4 T1-1 M21 A-N2M2-U H5		
Pipeliners 111M	E111T1-M21-A4-G, E111T1-GM							T76 4 T1-1 M21 A-G H5		
Pipeliners 81M	E81T1-M21A4-K11-H4, E81T1-GM-H4		E551T1-M21A4-K11-H4, E81T1-GM-H4					T55 4 T1-1 M21 A-N1-U H5		
Pipeliners Autoweld G70M	E81T1-M21A4-G-H8, E81T1-GM-H8									
Pipeliners G90M	E111T1-M21A2-K3-H8, E111T1-K3M-JH8	E111T1-K3M-JH4								
UltraCore 101K3M-H Plus	E101T1-M21A6-K3-H4, E91T1-M21P4-K3-H4, E101T1-K3M-JH4	E101T1-K3M-JH4, E101T1-M21A6-K3-H4								
UltraCore 111K3M-H Plus	E101T1-M21P4-K3-H4, E111T1-M21A6-K3-H4, E111T1-K3M-JH4	E111T1-K3M-JH4, E111T1-M21A6-K3-H4								
UltraCore 121K3M-H Plus	E111T1-M21P4-K3-H4, E121T1-M21A6-K3-H4, E121T1-GM-H4	E121T1-GM-H4, E121T1-M21A6-K3-H4								
UltraCore 308L	E308LT0-1, E308LT0-4	E308LT0-1, E308LT0-4	E308LT0-1, E308LT0-4							
UltraCore 308L P	E308LT1-1, E308LT1-4	E308LT1-1, E308LT1-4	E308LT1-1, E308LT1-4							
UltraCore 309L	E309LT0-1, E309LT0-4	E309LT0-1, E309LT0-4	E309LT0-1, E309LT0-4							
UltraCore 309L P	E309LT1-1, E309LT1-4	E309LT1-1, E309LT1-4	E309LT1-1, E309LT1-4							
UltraCore 316L	E316LT0-1, E316LT0-4	E316LT0-1, E316LT0-4	E316LT0-1, E316LT0-4							
UltraCore 316L P	E316LT1-1, E316LT1-4	E316LT1-1, E316LT1-4	E316LT1-1, E316LT1-4							
UltraCore 360 C71	E71T1-C1A4-CS1-H4, E71T-1C-JH4	4Y400400	E491T1-C1A4-CS1-H4 (E491T-9J-H4)		4Y40S H5		0.045", 0.052", 1/16"			
UltraCore 360 C81	E81T1-C1A8-Ni1-H4, E81T1-Ni1C-JH4	5YQ460					0.045"			
UltraCore 360 M71	E71T1-C1A0-CS1-H4, E71T1-M21A4-CS1-H4, E71T-1C-H4, E71T-1M-JH4	3YSA H5	E491T1-M21A4-CS1-H4 (E491T-9MJ-H4)		3Y40S H5		0.045", 0.052", 1/16"			
UltraCore 360 M81	E81T1-M21A8-Ni1-H4, E81T1-Ni1M-JH4	5YQ460					0.045"			
UltraCore 70C	E70T1-C1A2-CS1-H8, E70T-1C-H8, E70T-9C-H8	2YSA H10	E491T1-M21A2-CS1-H8				1/16", 5/64", 3/32"	T49 3 T1-0 C1 A H10		

# AGENCY APPROVALS

NOTE: Approvals are updated periodically.

*Consult your Lincoln Electric representative for the latest Approval/Grade revisions.*

Product	AWS A5	ABS	CWB/CSA	DNV	Lloyd's Register	BV	AWS D1.8	ISO	JIS	TUV
<b>FCAW-G</b>										
UltraCore 70M	E70T1-M21A2-CS1-H8 E70T-1M-H8, E70T-9M-H8		E490T1-M21A2-CS1-H8, E490T1-M21A3-CS1-H8, E492T-1M-H8, E492T-9M-H8							
UltraCore 712A80	E71T1-M21A4-CS2-H8, E71T-12M-JH8, E71T-1M-JH8, E71T-9M-JH8	4YSA H10	E491T-12MJ-H8, E491T1-M21A4-CS1-H8, E491T1-M21A4-CS2-H8, E491T-9MJ-H8	IV YMS H10	4YS H10			T49 4 T12-1 M21 A-K H10		
UltraCore 712A80-H	E71T1-M21A4-CS2-H4, E71T-12M-JH4, E71T-1M-JH4, E71T-9M-JH4	4YSA H5	E491T-12MJ-H4, E491T1-M21A4-CS1-H4, E491T1-M21A4-CS2-H4, E491T-9MJ-H4	IV YMS H5	4YS H5			T49 4 T12-1 M21 A-K H5		
UltraCore 712A80-H Plus	E71T1-M21A6-CS2-H4, E71T1-M21P5-CS2-H4, E71T-12M-JH4, E71T-1M-JH4, E71T-9M-JH4, E81T1-GM	4YSA H5	E491T-12MJ-H4, E491T1-M21A5-CS2-H4	IV YMS H5	4YS H5					
UltraCore 712C	E71T1-C1A4-CS2-H8 E71T-12C-JH8, E71T-1C-JH8 E71T-9C-JH8	3YSA H10	E491T1-C1A4-CS2-H8, E491T-9J-H8	III YMS H10	3YS H10		1/16"	T49 4 T12-1 C1 A-K H10		
UltraCore 712C-H Plus	E71T1-C1A6-CS2-H4, E71T1-C1P5-CS2-H4, E71T-12C-JH4, E81T1-GC	4YSA H5	E491T-12J-H4, E491T1-C1A5-CS2-H4	IV Y40MS H5	4YS H5					
UltraCore 71A75 Dual	E71T1-C1A2-CS1-H8, E71T1-M21A2-CS1-H8, E71T-1C-H8, E71T-1M-H8, E71T-9C-H8, E71T-9M-H8		E491T-9-H8, E491T-9M-H8					T49 3 T1-1 C1 A H10 T49 3 T1-1 M21 A H10		
UltraCore 71A85	E71T1-M21A2-CS1-H8 E71T-1M-H8, E71T-9M-H8	3YSA H10	E491T-9M-H8	III YMS H10	3YS H10		0.045", 0.052", 1/16"	T49 3 T1-1 M21 A H10		
UltraCore 71C	E71T1-C1A2-CS1-H8 E71T-1C-H8, E71T-9C-H8	E71T-9C-H8	E491T1-C1A3-CS1-H8, E491T-9-H8	III YMS H10	3YS H10		0.045", 0.052", 1/16"	T49 3 T1-1 C1 A H10		
UltraCore 75C	E70T5-C1A4-CS1-H4, E70T-5C-JH4		E490T5-C1A4-CS1-H4, E492T-5J-H4					T49 4 T5-0 C1 A H5		
UltraCore 80Ni1C	E80T1-C1A4-Ni1-H8, E80T1-Ni1C-JH8		E550T1-C1A4-Ni1-H8, E80T1-C1A4-Ni1-H8				1/16", 5/64", 3/32"			
UltraCore 80Ni1M	E80T1-M21A4-Ni1-H8, E80T1-Ni1M-JH8									
UltraCore 81K2C-H Plus	E81T1-C1A6-K2-H4, E81T1-C1P4-K2-H4, E81T1-K2C-JH4	4YQ4605A H5		IV Y46MS H5	4Y46S H5					
UltraCore 81K2M-H Plus	E81T1-K2M-JH4, E81T1-M21A6-K2-H4, E81T1-M21P4-K2-H4									
UltraCore 81Ni1A75-H	E81T1-M21A4-Ni1-H4, E81T1-Ni1M-JH4	4YQ4605A H5	E551T1-M21A4-Ni1M-H4, E551T1-Ni1M-JH4	IV Y46MS H5	4Y46S H5		0.045", 0.052", 1/16"	T55 4 T1-1 M21 A-N2 H5		
UltraCore 81Ni1C-H	E81T1-C1A4-Ni1-H4, E81T1-Ni1C-JH4	4YQ4605A H5	E551T1-C1A4-Ni1-H4, E551T1-Ni1C-JH4	IV Y46MS H5	4Y46S H5		0.045", 0.052", 1/16"	T55 4 T1-1 C1 A-N2- H5		
UltraCore 81Ni1C-H Plus	E81T1-C1A6-Ni1-H4, E81T1-C1P4-Ni1-H4, E81T1-Ni1C-JH4	4YQ4605A H5	E551T1-C1A5-Ni1-H4, E551T1-Ni1C-JH4	IV Y46MS H5	4Y46S H5		0.045", 0.052", 1/16"			
UltraCore 81Ni1M-H Plus	E81T1-M21A6-Ni1-H4, E81T1-M21P4-Ni1-H4, E81T1-Ni1M-JH4	4YQ4605A H5	E551T1-M21A5-Ni1-H4, E551T1-Ni1M-JH4	IV Y46MS H5	4Y46S H5		0.045", 0.052", 1/16"			
UltraCore 81Ni2A75-H	E81T1-M21A6-Ni2-H4, E81T1-Ni2M-JH4	3YSA H5	E551T1-M21A5-Ni2-H4, E551T1-Ni2M-JH4	III Y40MS H5	3YS H5			T55 6 T1-1 M21 A-N5 H5		
UltraCore 81Ni2C-H	E81T1-C1A6-Ni2-H4, E81T1-Ni2C-JH4	3YSA H5	E551T1-C1A5-Ni2-H4, E551T1-Ni2C-JH4	III Y40MS H5	3YS H5			T55 6 T1-1 C1 A-N5 H5		

# AGENCY APPROVALS

NOTE: Approvals are updated periodically.

*Consult your Lincoln Electric representative for the latest Approval/Grade revisions.*

Product	AWS A5	ABS	CWB/CSA	DNV	Lloyd's Register	BV	AWS D1.8	ISO	JIS	TUV
<b>FCAW-G</b>										
UltraCore 91K2C-H Plus	E91T1-C1A6-K2-H4, E91T1-C1P4-K2-H4, E91T1-K2C-JH4	4YQ500SA H5		IV Y50MS H5	4Y50S H5					
UltraCore 91K2M-H Plus	E91T1-K2M-JH4, E91T1-M21A6-K2-H4, E91T1-M21P4-K2-H4	4YQ500SA H5	E621T1-M21A5-K2-H4, E91T1-M21A6-K2-H4	IV Y50MS H5	4Y50S H5					
UltraCore Clarity C71 LE	E71T1-C1A0-CS1-H8, E71T-1C-H8		E491T-1-H8							
UltraCore FC 308L	E308LT0-1, E308LT0-4, E308T0-1, E308T0-4	E308LT0-1, E308LT0-4, E308T0-1, E308T0-4	E308LT0-1, E308LT0-4							
UltraCore FC 309L	E309LT0-1, E309LT0-4, E309T0-1, E309T0-4	E309LT0-1, E309LT0-4, E309T0-1, E309T0-4	E309LT0-1, E309LT0-4							
UltraCore FC 316L	E316LT0-1, E316LT0-4, E316T0-1, E316T0-4	E316LT0-1, E316LT0-4, E316T0-1, E316T0-4	E316LT0-1, E316LT0-4							
UltraCore FCP 308L	E308LT1-1, E308LT1-4, E308T1-1, E308T1-4	E308LT1-1, E308LT1-4, E308T1-1, E308T1-4	E308LT1-1, E308LT1-4							
UltraCore FCP 309L	E309LT1-1, E309LT1-4, E309T1-1, E309T1-4	E309LT1-1, E309LT1-4, E309T1-1, E309T1-4	E309LT1-1, E309LT1-4							
UltraCore FCP 316L	E316LT1-1, E316LT1-4, E316T1-1, E316T1-4	E316LT1-1, E316LT1-4, E316T1-1, E316T1-4	E316LT1-1, E316LT1-4							
UltraCore HD Marine	E71T1-C1A2-CS1-H8, E71T-1C-H8, E71T-9C-H8	2Y400SA H10 2YSA H10		II YMS H10	2YS H10	SA2Y H10				
UltraCore HD-12C	E71T1-C1A4-CS2-H8, E71T-12C-JH8, E71T-1C-JH8, E71T-9C-JH8	3YSA H10	E491T-12J-H8, E491T1-C1A4-CS2-H8, E491T-9J-H8	III YMS H10	3YS H10			T49 4 T12-1 C1 A-K H10		
UltraCore HD-12M	E71T1-M21A4-CS2-H8, E71T-12M-JH8, E71T-1M-JH8, E71T-9M-JH8	3Y400SA H10 3YSA H10	E491T-12MJ-H8, E491T1-M21A4-CS2-H8	III YMS H10	3YS H10			T49 4 T12-1 M21 A-K H10		
UltraCore HD-C	E71T1-C1A2-CS1-H8, E71T-1C-H8, E71T-9C-H8	3YSA H10	E491T-9-H8	III YMS H10	3YS H10		0.045", 0.052", 1/16"	T49 3 T1-1 C1 A H10		
UltraCore HD-M	E71T1-M21A2-CS1-H8 E71T-1M-H8, E71T-9M-H8	3YSA H10	E491T-9M-H8	III YMS H10	3YS H10			T49 3 T1-1 M21 A H10		
UltraCore MIL-HYC	E71T1-C1A4-CS2-H4, E71T-12C-JH4									
UltraCore MIL-HYD	E71T1-C1A4-CS2-H4, E71T-12C-JH4	3YSA H5								
UltraCore MIL-HYM	E71T1-M21A4-CS2-H4, E71T-12M-JH4									
UltraCore MIL-HYN	E71T1-M21A4-CS2-H4, E71T-12M-JH4									
UltraCore XP70	E70T1-C1A2-CS1-H8, E70T-1C-H8, E70T-9C-H8						1/16", 5/64", 3/32"			
Innershield NR-207	E71T8-A2-K6-H16 E71T8-K6-H16	E71T8-K6	E491T8-A3-K6-H16 E491T8-K6-H16	III YMS H15		SA3YMH		T49 3 T8-1 NO A-N1 H15		

# AGENCY APPROVALS

NOTE: Approvals are updated periodically.

*Consult your Lincoln Electric representative for the latest Approval/Grade revisions.*

Product	AWS A5	ABS	CWB/CSA	DNV	Lloyd's Register	BV	AWS D1.8	ISO	JIS	TUV
<b>FCAW-S</b>										
Innershield NR-131	E70T-10 E70T105									
Innershield NR-152	E71T-14 E71T145							T49 T14-1 NO SA-G		
Innershield NR-203 Nickel (1%)	E71T8-A2-Ni1-H16, E71T8-Ni1-H16	3YSA	E491T8-A3-Ni1-H16, E491T8-Ni1-H16	III YMS H10	3YS H15			T49 4 T8-1 NO A-N2 H15		
Innershield NR-203MP	E71T8-A4-CS3-H8, E71T-8-JH8	3YSA H15	E491T8-A3-CS3-H8, E491T-8-H8	III YMS H10	3YS H15	SA3YMH		T49 4 T8-1 NO AH10		
Innershield NR-207	E71T8-A2-K6-H16, E71T8-K6-H16	E71T8-K6	E491T8-A3-K6-H16, E491T8-K6-H16	III YMS H15		SA3YMH		T49 3 T8-1 NO A-N1 H15		
Innershield NR-208-H	E91T8-AG-G-H8, E91T8-G-H8									
Innershield NR-211-MP	E71T-11, E71T11-AZ-CS3	E71T-11	E491T-11-H16					T49 Z T11-1 NO AH15		
Innershield NR-211-MP JIS	E71T-11, E71T11-AZ-CS3								T49 T14-1NS	
Innershield NR-212	E71TG-AZ-G-H16, E71TG-G-H16		E491TG-AZ-G-H16, E491TG-G-H16					T49 Z T11-1 NO A-G H15		
Innershield NR-232	E71T8-A2-CS3-H16, E71T-8-H16	3YSA	E491T8-A3-CS3-H16, E491T-8-H16	III YMS H15	3YS H15	SA3YMH	0.068", 0.072", 5/64"	T55 3 T8-1 NO AH15	T49 3 T7-1 N A	
Innershield NR-232-H	E71T8-A2-CS3-H8, E71T-8-H8		E491T-8-H8				0.068", 0.072"			
Innershield NR-233	E71T8-A2-CS3-H8, E71T-8-H8	E71T-8-H16					0.072", 1/16", 5/64"	T49 3 T8-1 NO AH10		
Innershield NR-233 JIS	E71T8-A2-CS3-H8, E71T-8-H8								T49 3 T7-1 N A	
Innershield NR-305	E70T6-A2-CS3-H8, E70T-6-H8	2YSA E70T-6-H16		II YMS			5/64", 3/32"	T 42 0 W N 3 H15		
Innershield NR-305 JIS	E70T6-A2-CS3-H8, E70T-6-H8								T49 3 T6-0 N A	
Innershield NR-311	E70T-7, E70T7-AZ-CS3	E70T-7	E490T7-AZ-CS3, E492T-7							
Innershield NR-311 Ni	E70T7-A2-K2-H16, E80TG-A2-K2-H16, E70T7-K2-H16, E80TG-K2-H16	2YSA		II YMS	2YS	SA2YM	3/32"			
Innershield NR-440Ni2	E71T8-A4-Ni2-H8, E71T8-Ni2-JH8	4YSA H5		IV YMS H5	4YS H5			T49 4 T8-1 NO A-N5 H5		
Innershield NR-5	E70T-3, E70T3S									
Innershield NR-555	E81T8-A5-K8-H8, E81T8-G		E551T8-G, E81T8-G				1/16", 5/64"	T46 5 Z Y NO 1 H10 T55 5 T8-1 NO A-G H10		
Innershield NR-555 JIS	E81T8-A5-K8-H8, E81T8-G								T55 5 T7-1 N A N2M1	
Innershield NS-3M	E70T-4, E70T4-AZ-CS3		E490T4-AZ-CS3-H16, E492T-4-H16					T49 Z T4-0 NO AH15		
Pipelinor NR-207+	E71T8-A2-K6, E71T8-K6	E71T8-K6						T49 3 T8-1 NO A-N1 H15		
Pipelinor NR-208-P	E81T8-A2-K11-H8, E81T8-G-H8									
Pipelinor NR-208-XP	E81T8-A4-K12, E81T8-G							T 55 4 T8-1 NO A-G H15		



# AGENCY APPROVALS

NOTE: Approvals are updated periodically.

*Consult your Lincoln Electric representative for the latest Approval/Grade revisions.*

Product	AWS A5	ABS	CWB/CSA	DNV	Lloyd's Register	BV	AWS D1.8	ISO	JIS	TUV
<b>GMAW</b>										
Blue Max MIG 2209	ER2209	ER2209								
Blue Max MIG 2594	ER2594	ER2594								
Blue Max MIG 307								18 8 Mn		
Blue Max MIG 308H	ER308, ER308H									
Blue Max MIG 308L	ER308, ER308L	ER308, ER308L	ER308, ER308L							
Blue Max MIG 308LCF	ER308, ER308L									
Blue Max MIG 308LSi	ER308LSi, ER308Si	ER308LSi, ER308Si	ER308LSi, ER308Si					SS308LSi		
Blue Max MIG 309L	ER309, ER309L	ER309, ER309L	ER309, ER309L							
Blue Max MIG 309LSi	ER309LSi, ER309Si	ER309LSi, ER309Si	ER309LSi, ER309Si					SS309LSi		
Blue Max MIG 310	ER310	ER310								
Blue Max MIG 312	ER312		ER312							
Blue Max MIG 316L	ER316, ER316L	ER316, ER316L	ER316, ER316L							
Blue Max MIG 316LCF	ER316, ER316L									
Blue Max MIG 316LSi	ER316LSi, ER316Si	ER316LSi, ER316Si	ER316LSi, ER316Si					SS316LSi		
Blue Max MIG 317L	ER317, ER317L									
Blue Max MIG 320LR	ER320LR									
Blue Max MIG 330	ER330									
Blue Max MIG 347	ER347	ER347								
Blue Max MIG 385	ER385		ER385							
Blue Max MIG 409Nb	ER409Nb									
Blue Max MIG 410	ER410									
Blue Max MIG 410NiMo	ER410NiMo									
Blue Max MIG 420	ER420									
Blue Max MIG 4370M								18 8 Mn		
Blue Max MIG 630	ER630									
LINCOLN AUTO7								G 18 8 Mn		
LINCOLN AUTO8	ER308LSi, ER308Si		ER308LSi, ER308Si					SS308LSi SS308Si		
LINCOLN AUTO9	ER309LSi, ER309Si		ER309LSi, ER309Si					SS309LSi SS309Si		

# AGENCY APPROVALS

NOTE: Approvals are updated periodically.

*Consult your Lincoln Electric representative for the latest Approval/Grade revisions.*

Product	AWS A5	ABS	CWB/CSA	DNV	Lloyd's Register	BV	AWS D1.8	ISO	JIS	TUV
<b>GMAW</b>										
LINCOLN Red Max 307_MOD								G 18 8 Mn		
LINCOLN Red Max 308LSi	ER308LSi, ER308Si	ER308LSi, ER308Si						SS308LSi SS308Si		
LINCOLN Red Max 309LSi	ER309LSi, ER309Si	ER309LSi, ER309Si						SS309LSi SS309Si		
LINCOLN Red Max 316LSi	ER316LSi, ER316Si	ER316LSi, ER316Si						SS316LSi SS316Si		
Pipeliner 120S-G	ER120S-G									
Pipeliner 70S-6	ER70S-6	3YSA								
Pipeliner 70S-G	ER70S-G							G 49A Z C1 SZ		
Pipeliner 80Ni1	ER80S-G	5YQ5005A H10	ER80S-G	V Y50MS H5	5Y50S H5			G 50 6 M21 3Ni1 G 57A 6 M21 SZ		
Pipeliner 80S-G	ER80S-G							G59A 3 M21 4M31		
SuperArc AK-10	ER100S-G									
SuperArc G4Si1	ER70S-6							G 46 3 C1 4Si1 G 50 5 M20 4Si1		
SuperArc L-50	ER70S-3	3YSA H5	B-G 49A 3 C1 S3	III YMS H5	3YS H5			G 49A 2 C1 S3		
SuperArc L-52	ER70S-2									
SuperArc L-56	ER70S-6	3YSA H5	B-G 49A 3 C1 S6	III YMS H5	3YS H5			G 42 4 M20 3Si1 G 49A 3 C1 S6		
SuperArc L-58	ER70S-3		B-G 49A 3 C1 S3					G 49A 2 C1 S3		
SuperArc L-59	ER70S-6	3YSA H5	B-G 49A 3 C1 S6	III Y40MS H5	3YS H5	SA3Y- HHH		G 42 4 M20 3Si1		
SuperArc LA-100	ER100S-G, ER110S-G	4YQ5505A	ER100S-G					SZ		
SuperArc LA-101	ER100S-1									
SuperArc LA-75	ER80S-Ni1		ER80S-Ni1					G 55A 4 M13 SN2 SUN21		
SuperArc LA-90	ER80S-D2, ER90S-D2		ER80S-D2, ER90S-D2					G59A 3 C1 4M31 G62A 3 M13 4M31		
SuperGlide S3	ER70S-3		B-G 49A 2 C1 S3					G 49A 2 C1 S3		
SuperGlide S6	ER70S-6		B-G 49A 3 C1 S6					G 49A 3 C1 S6		
Techalloy 686	ERNiCrMo-14									
Techalloy 99	ERNi-CI									
Techalloy X	ERNiCrMo-2									

# AGENCY APPROVALS

NOTE: Approvals are updated periodically.

*Consult your Lincoln Electric representative for the latest Approval/Grade revisions.*

Product	AWS A5	ABS	CWB/CSA	DNV	Lloyd's Register	BV	AWS D1.8	ISO	JIS	TUV
<b>GMAW-C</b>										
Metalshield Clarity MC-707	E70C-6M-H4, E70T15-M20A4-CS1-H4		E490T15-M20A3-CS1-H4, E490T15-M21A3-CS1-H4							
Metalshield MC-110	E110C-K4-H4, E110T15-M20A6-K4-H4, E110T15-M21A6-K4-H4		E110C-K4 H4					T76 6 T15-0 M A-N4C1M2 H5		
Metalshield MC-120	E120C-K4-H4, E120T15-M20A6-K4-H4		E83C-K4-H4							
Metalshield MC-6	E70C-6M-H8							T49 4 T15-1 M A H5		
Metalshield MC-70 XLS	E70C-6M-H4, E70T15-M20A4-CS1-H4, E70T15-M21A4-CS1-H4									
Metalshield MC-706	E70C-6M-H4, E70T15-M20A4-CS1-H4, E70T15-M21A4-CS1-H4	E70C-6M-H4	E492C-6MJ-H4	IV Y40MS H5			0.045" 0.052" 1/16"	T49 4 T15-0 M A H5		
Metalshield MC-706 Buy America	E70C-6M-H4, E70T15-M20A4-CS1-H4, E70T15-M21A4-CS1-H4									
Metalshield MC-710XL	E70C-6M-H8, E70C-G-H8, E70T15-M20A2-CS1-H8, E70T15-M21A2-CS1-H8		E491C-6M-H8, E491T15-M20A3-CS1-H8, E491T15-M21A3-CS1-H8							
Metalshield MC-80 XLS	E80C-Ni1-H4, E80T15-M20A5-Ni1-H4, E80T15-M21A5-Ni1-H4, E80T15-M22A5-Ni1-H4									
Metalshield MC-90	E90C-K3-H4, E90T15-M20A6-K3-H4, E90T15-M21A6-K3-H4		E90C-K3 H4					T62 6 T15-0 M A-N3M2 H5		
Metalshield Z	E70C-GS							T3T Z Z M M20 3 T49 Z TG-0 M20 S A-G		
Metalshield Z JIS									T49 T15-0 G S G	
Outersield MC-409	EC409									
<b>GTAW</b>										
Blue Max Orbital TIG 308L	ER308L									
Blue Max Orbital TIG 308L N	ER308L									
Blue Max Orbital TIG 309L	ER309L									
Blue Max Orbital TIG 309L N	ER309L									
Blue Max Orbital TIG 316L	ER316, ER316L	ER316, ER316L						SS316L		
Blue Max Orbital TIG 316L N	ER316L									
Lincoln 70S-6	ER70S-6									
Lincoln AK-10	ER100S-G									
Lincoln ER100S-1	ER100S-1									
Lincoln ER2209	ER2209	ER2209								
Lincoln ER2594	ER2594	ER2594								

# AGENCY APPROVALS

NOTE: Approvals are updated periodically.

*Consult your Lincoln Electric representative for the latest Approval/Grade revisions.*

Product	AWS A5	ABS	CWB/CSA	DNV	Lloyd's Register	BV	AWS D1.8	ISO	JIS	TUV
<b>GTAW</b>										
Lincoln ER308/308H	ER308, ER308H									
Lincoln ER308/308L	ER308, ER308L	ER308, ER308L	ER308, ER308L					SS308L		
Lincoln ER308/308L N	ER308, ER308L									
Lincoln ER308/308LCF	ER308 ER308L									
Lincoln ER308Si/308LSi	ER308LSi, ER308Si									
Lincoln ER309/309L	ER309, ER309L	ER309, ER309L	ER309, ER309L					SS309L		
Lincoln ER309/309L N	ER309, ER309L									
Lincoln ER309LMo								23 12 2 L		
Lincoln ER309Si/309LSi	ER309LSi, ER309Si							SS309LSi SS309Si		
Lincoln ER310	ER310	ER310								
Lincoln ER312	ER312		ER312							
Lincoln ER316/316L	ER316, ER316L	ER316, ER316L	ER316, ER316L					SS316L		
Lincoln ER316/316L N	ER316, ER316L									
Lincoln ER316/316LCF	ER316, ER316L									
Lincoln ER316LSi	ER316LSi									
Lincoln ER316Si/316LSi	ER316LSi, ER316Si									
Lincoln ER317/317L	ER317, ER317L									
Lincoln ER320LR	ER320LR									
Lincoln ER347	ER347	ER347								
Lincoln ER385	ER385									
Lincoln ER409Nb	ER409Nb									
Lincoln ER410	ER410									
Lincoln ER410NiMo	ER410NiMo									
Lincoln ER630	ER630									
Lincoln ER705-2	ER705-2		ER705-2					W 49 2		
Lincoln ER705-3	ER705-3									
Lincoln ER705-6	ER705-6		B-G 49A 3 C1 56					W 49 6		
Lincoln ER805-B2	ER805-B2									
Lincoln ER805-D2	ER805-D2, ER905-D2									

# AGENCY APPROVALS

NOTE: Approvals are updated periodically.

*Consult your Lincoln Electric representative for the latest Approval/Grade revisions.*

Product	AWS A5	ABS	CWB/CSA	DNV	Lloyd's Register	BV	AWS D1.8	ISO	JIS	TUV
<b>GTAW</b>										
Lincoln ER805-Ni1	ER805-Ni1									
Lincoln ER905-B3	ER905-B3									
Lincoln LA-84 GTAW	ER905-G									
Pipelinex 1105-G	ER1105-G									
SuperArc Orbital TIG AK-10	ER1005-G									
SuperArc Orbital TIG ER1005-1	ER1005-1									
SuperArc Orbital TIG ER805-B2	ER805-B2									
SuperArc Orbital TIG L-52 N	ER705-2									
SuperArc Orbital TIG L-56 N	ER705-6									
Techalloy 208	ERNi-1		ERNi-1							
Techalloy 276	ERNiCrMo-4		ERNiCrMo-4							
Techalloy 413	ERCuNi	ERCuNi	ERCuNi							
Techalloy 418	ERNiCu-7		ERNiCu-7							
Techalloy 606	ERNiCr-3		ERNiCr-3							
Techalloy 617	ERNiCrCoMo-1		ERNiCrCoMo-1							
Techalloy 622	ERNiCrMo-10		ERNiCrMo-10							
Techalloy 625	ERNiCrMo-3	ERNiCrMo-3						S Ni 6625 (NiCr22Mo9Nb)		
Techalloy 686			ERNiCrMo-14							
Techalloy 718	ERNiFeCr-2		ERNiFeCr-2							
Techalloy 825	ERNiFeCr-1	ERNiFeCr-1	ERNiFeCr-1							
<b>SAW</b>										
Lincolnweld 760 / Lincolnweld L-50	F7A0-EM13K-H8									
Lincolnweld 760 / Lincolnweld L-60	F6A2-EL12-H8		F43A3-EL12-H8							
Lincolnweld 760 / Lincolnweld L-61	F7A2-EM12K		F49A3-EM12K-H8							
Lincolnweld 760								S A C S 1 S A G S 1 S A M S 1		
Lincolnweld 761 / Lincolnweld Emergence 70	F8TA0-EA1									

# AGENCY APPROVALS

NOTE: Approvals are updated periodically.

*Consult your Lincoln Electric representative for the latest Approval/Grade revisions.*

Product	AWS A5	ABS	CWB/CSA	DNV	Lloyd's Register	BV	AWS D1.8	ISO	JIS	TUV
<b>SAW</b>										
Lincolnweld 761 / Lincolnweld L-50	F7A2-EM13K-H8		F49A3-EM13K-H8							
Lincolnweld 761 / Lincolnweld L-60	F7A2-EL12-H8	F7A2-EL12-H8	F49A3-EL12-H8							
Lincolnweld 761 / Lincolnweld L-61	F8TAZG-EM12K	F7A2-EM12K-H4	F49A3-EM12K-H8	III YM	3YM	A3YM				
Lincolnweld 761 / Lincolnweld L-70	F9A0-EA1-G	3YT 3YM	F62A2-EA1-G-H8	III YTM						
Lincolnweld 761 / Lincolnweld LA-75	F8A0-EM11K-G-H8									
Lincolnweld 761								S A C S 1 S A G S 1 S A M S 1		
Lincolnweld 761 BU / Lincolnweld L-70			F9A0-EA1-G-H8							
Lincolnweld 761-Pipe / Lincolnweld Emergence 61	F7TAZ-EM12K-H4									
Lincolnweld 761-Pipe / Lincolnweld L-50	F7A2-EM13K-H4									
Lincolnweld 761-Pipe / Lincolnweld L-60	F7A2-EL12-H4									
Lincolnweld 761-Pipe / Lincolnweld L-61	F7A2-EM12K-H4		F49A3-EM12K-H4							
Lincolnweld 761-Pipe								S A C S 1 S A G S 1 S A M S 1		
Lincolnweld 780 / Lincolnweld L-50	F7A0-EM13K-H8									
Lincolnweld 780 / Lincolnweld L-60	F7A0-EL12-H8	F7A0-EL12-H8	F49A2-EL12-H8		2YM					S A A R 1 78 A C H 5
Lincolnweld 780 / Lincolnweld L-61	F7A2-EM12K-H8	F7A2-EM12K-H8	F49A3-EM12K-H8	II YTM	2YM	A3YT A2YM				S A A R / A B 1 78 A C H 5
Lincolnweld 780								S A A B 1 S A A R 1		
Lincolnweld 781 / Lincolnweld L-50	F7A0-EM13K-H8		F49A2-EM13K-H8							
Lincolnweld 781 / Lincolnweld L-60	F7A0-EL12									
Lincolnweld 781 / Lincolnweld L-61	F7A0-EM12K		F49A2-EM12K-H8							
Lincolnweld 781 / Lincolnweld L-70	F9A0-EA1-G									
Lincolnweld 781								S A Z S 1		
Lincolnweld 801								S A F B 1/2		
Lincolnweld 802								S A Z 1/2		
Lincolnweld 812-SRC / Lincolnweld AK-10	F10P4-EG-G-H4									
Lincolnweld 812-SRC / Lincolnweld LA-84 (LNS 164)	F10A6-EF3-F3-H4, F10P6-EF3-F3-H4, F9P6-EF3-F3-H4									
Lincolnweld 812-SRC								S A F B 1		
Lincolnweld 822 / Lincolnweld LA-71	F7A8-EM14K-H4, F7P8-EM14K-H4		F49P6-EM14K-H4, F49A6-EM14K-H4							

# AGENCY APPROVALS

NOTE: Approvals are updated periodically.

*Consult your Lincoln Electric representative for the latest Approval/Grade revisions.*

Product	AWS A5	ABS	CWB/CSA	DNV	Lloyd's Register	BV	AWS D1.8	ISO	JIS	TUV
<b>SAW</b>										
Lincolnweld 822 / Lincolnweld LA-92 (LNS 150)	F62A3-EB2R-B2R-H4, F8P4-EB2R-B2R-H4, F9A2-EB2R-B2R-H4		F62A2-EB2R-B2R-H4 F55P4-EB2R-B2R-H4							
Lincolnweld 822 / Lincolnweld LA-93 (LNS 151)	F9P4-EB3R-B3R-H4		F62P4-EB3R-B3R-H4							
Lincolnweld 822								S A FB 1		
Lincolnweld 842-H / Lincolnweld L-61	F6P8-EM12K-H4, F7A6-EM12K-H4									
Lincolnweld 842-H / Lincolnweld LA-84 (LNS 164)	F10A8-EF3-F3-H4, F9A8-EF3-F3-H4, F9P8-EF3-F3-H4	5YQ550M H5		V Y55M H5	5Y55 H5					
Lincolnweld 842-H / Lincolnweld LA-85 (LNS 165)	F8A8-ENi5-Ni5-H4, F8P8-ENi5-Ni5-H4	5YQ500M H5		V Y50M H5	5Y50M H5					
Lincolnweld 842-H / Lincolnweld LAC-690	F10A10-ECF5-F5-H4	5YQ620M H5		V Y62M H5	5Y62M H5					
Lincolnweld 842-H / Lincolnweld L-53 (LNS133U, L50M)	F7A8-EH12K-H4, F7P8-EH12K-H4	5YQ420M H5		V Y42M H5	5Y42M H5					
Lincolnweld 842-H								S A FB 1		
Lincolnweld 8500 / Lincolnweld L-50	F7A8-EM13K-H8									
Lincolnweld 8500 / Lincolnweld L-56	F7A8-EH11K-H8, F7P8-EH11K-H8									
Lincolnweld 8500 / Lincolnweld L-61	F7A6-EM12K-H8	4YM		IV YM	4YM H10					
Lincolnweld 8500 / Lincolnweld L-70	F7A4-EA1-G-H8		F49A4-EA1-G-H8	III YMS H10	3YM H10					
Lincolnweld 8500 / Lincolnweld LA-71	F7A8-EM14K-H8, F7P8-EM14K-H8									
Lincolnweld 8500 / Lincolnweld LA-81 (LNS 140TB)	F9TA4G-EG									
Lincolnweld 8500 / Lincolnweld LA-85 (LNS 165)	F7P6-ENi5-Ni5-H8, F8A8-ENi5-Ni5-H8	5YQ460M, 5YQ460M H5	F55A6-ENi5-Ni5-H8, F49P5-ENi5-Ni5-H8	V Y46M H10	5Y46M H10					
Lincolnweld 8500 / Lincolnweld LA-90	F9A2-EA3K-A3-H8									
Lincolnweld 8500 / Lincolnweld LA-92 (LNS 150)	F8P0-EB2R-B2R-H8									
Lincolnweld 8500 / Lincolnweld LA-93 (LNS 151)	F9P0-EB3R-B3R									
Lincolnweld 8500 / Lincolnweld L-53 (LNS133U,L50M)	F7A8-EH12K-H8	5YQ420M		V Y42M H10	5Y42M H5					
Lincolnweld 8500								S A FB 1		
Lincolnweld 860 / Lincolnweld L-50	F7A2-EM13K-H4		F49A3-EM13K-H4							
Lincolnweld 860 / Lincolnweld L-56	F7A2-EH11K-H4, F7P2-EH11K-H4									
Lincolnweld 860 / Lincolnweld L-60	F6A2-EL12-H4	F6A2-EL12-H4								SA AB 1 66 AC H5
Lincolnweld 860 / Lincolnweld L-61	F6P5-EM12K-H8, F7A2-EM12K-H8, F7A4-EM12K-H8	F7A2-EM12K-H8	F49A4-EM12K-H8	III YM, II YT	3YM	A3YM A2YT				SA AB 1 66 AC H5

# AGENCY APPROVALS

NOTE: Approvals are updated periodically.

*Consult your Lincoln Electric representative for the latest Approval/Grade revisions.*

Product	AWS A5	ABS	CWB/CSA	DNV	Lloyd's Register	BV	AWS D1.8	ISO	JIS	TUV
<b>SAW</b>										
Lincolnweld 860 / Lincolnweld L-70	F7A2-EA1-A2-H4, F7P2-EA1-A2-H4									SA AB 1 66 AC H5
Lincolnweld 860 / Lincolnweld LA-71	F7A2-EM14K-H4, F7P2-EM14K-H4									
Lincolnweld 860 / Lincolnweld LA-75	F7A2-ENi1K-Ni1-H4, F7P2-ENi1K-Ni1-H4									
Lincolnweld 860 / Lincolnweld LA-81 (LNS 140TB)	F9TA6G-EA2TiB									
Lincolnweld 860 / Lincolnweld LA-85 (LNS 165)	F8A4-ENi5-Ni5-H4									
Lincolnweld 860 / Lincolnweld L-53 (LNS133U,L50M)	F7A2-EH12K-H4									
Lincolnweld 860								SA AB 1		
Lincolnweld 860 / Pipeliner LA-85	F7A2-ENi1K-Ni1-H4									
Lincolnweld 865 / Lincolnweld L-50	F7A2-EM13K-H8, F7P5-EM13K-H8									
Lincolnweld 865 / Lincolnweld L-61	F7A2-EM12K-H8, F7P2-EM12K-H8									
Lincolnweld 865 / Lincolnweld LA-71	F7A2-EM14K-H8									
Lincolnweld 865 / Lincolnweld LA-75	F8A2-ENi1K-G-H8, F8P2-ENi1K-G-H8									
Lincolnweld 865								SA AB 1 SA AR 1		
Lincolnweld 880 / Lincolnweld LA-100	F9A4-EM2-M2-H8									
Lincolnweld 880 / Lincolnweld LA-75	F7A8-ENi1K-Ni1-H8									
Lincolnweld 880 / Lincolnweld LA-90	F8A4-EA3K-A4-H8									
Lincolnweld 880 / Lincolnweld LAC-B2	F8P2-ECB2-B2-H8									
Lincolnweld 880 / Lincolnweld LAC-Ni2	F7P10-ECCNi2-Ni2-H8, F7A6-ECCNi2-Ni2-H8	F7P10-ECCNi2-Ni2-H8								
Lincolnweld 880M / Lincolnweld L-50	F7A8-EM13K-H8	3Y400M 3YM		V YM	3YM					
Lincolnweld 880M / Lincolnweld L-56	F7A6-EH11K-H8, F7P6-EH11K-H8	4YM	F49A6-EH11K-H8	IV YM						
Lincolnweld 880M / Lincolnweld LA-100	F9A6-EM2-M2-H8									
Lincolnweld 880M / Lincolnweld LA-71	F7A8-EM14K-H8, F7P8-EM14K-H8	5YQ460M H5		IV Y 46M H5						
Lincolnweld 880M / Lincolnweld LA-75	F7A8-ENi1K-Ni1-H8		F49A6-ENi1K-Ni1-H8							
Lincolnweld 880M / Lincolnweld LA-85 (LNS 165)	F7A6-ENi5-Ni5-H8, F7P8-ENi5-Ni5-H8, F8A6-ENi5-Ni5-H8									
Lincolnweld 880M / Lincolnweld LA-90	F9P8-EA3K-A3-H8, F9A6-EA3K-A3-H8									
Lincolnweld 880M / Lincolnweld LA-92 (LNS 150)	F7P2-EB2-B2-H8									



# AGENCY APPROVALS

NOTE: Approvals are updated periodically.

*Consult your Lincoln Electric representative for the latest Approval/Grade revisions.*

Product	AWS A5	ABS	CWB/CSA	DNV	Lloyd's Register	BV	AWS D1.8	ISO	JIS	TUV
<b>SAW</b>										
Lincolnweld 880M / Lincolnweld LA-93 (LNS 151)	F7P0-EB3-B3-H8									
Lincolnweld 880M / Lincolnweld LAC-B2	F8P2-ECB2-B2-H8									
Lincolnweld 880M / Lincolnweld LAC-Ni2	F7P10-ECNi2-Ni2-H8, F7A10-ECNi2-Ni2-H8									
Lincolnweld 880M / Lincolnweld L-53 (LNS133U,L50M)	F7A6-EH12K-H8									
Lincolnweld 880M								SA FB 1		
Lincolnweld 882 / Lincolnweld L-50	F7A6-EM13K-H8									
Lincolnweld 882 / Lincolnweld L-56	F7A4-EH11K-H8, F7P5-EH11K-H8									
Lincolnweld 882 / Lincolnweld L-60	F6A6-EL12-H8									
Lincolnweld 882 / Lincolnweld L-61	F7A6-EM12K-H8	F7A6-EM12K-H8	F49A6-EM12K-H8							
Lincolnweld 882 / Lincolnweld L-70	F7P4-EA1-A2-H8									
Lincolnweld 882 / Lincolnweld LA-71	F7A6-EM14K-H8, F7P6-EM14K-H8									
Lincolnweld 882 / Lincolnweld LA-75	F7A4-ENi1K-Ni1-H8									
Lincolnweld 882 / Lincolnweld LA-84 (LNS 164)	F9A6-EF3-F3-H8, F9P6-EF3-F3-H8									
Lincolnweld 882 / Lincolnweld LA-85 (LNS 165)	F7A4-ENi5-Ni5-H8, F7P4-ENi5-Ni5-H8									
Lincolnweld 882 / Lincolnweld LA-92 (LNS 150)	F7P2-EB2-B2-H8									
Lincolnweld 882 / Lincolnweld LA-93 (LNS 151)	F9P0-EB3-B3-H8									
Lincolnweld 882 / Lincolnweld LAC-Ni2	F7P4-ECNi2-Ni2-H8, F8A4-ECNi2-Ni2-H8									
Lincolnweld 882 / Lincolnweld L-53 (LNS133U, L50M)	F7P8-EH12K-H8, F7A6-EH12K-H8									
Lincolnweld 888 / Lincolnweld L-50	F7A8-EM13K-H4									
Lincolnweld 888 / Lincolnweld L-56	F7P8-EH11K-H8, F8A6-EH11K-G-H4	5YQ500M H5		V Y50M H5	5Y50M H5					
Lincolnweld 888 / Lincolnweld L-61	F7A6-EM12K-H4		F49A5-EM12K-H4							
Lincolnweld 888 / Lincolnweld L-70	F7P4-EA1-A2-H4, F7A4-EA1-A2-H4									
Lincolnweld 888 / Lincolnweld LA-100	F10A4-EM2-M2-H4									
Lincolnweld 888 / Lincolnweld LA-71	F7P8-EM14K-H4, F7A6-EM14K-H4									
Lincolnweld 888 / Lincolnweld LA-75	F7A8-ENi1K-Ni1-H4									
Lincolnweld 888 / Lincolnweld LA-84 (LNS 164)	F8P6-EF3-F3-H4, F9A8-EF3-F3-H4, F9P6-EF3-F3-H4	4YQ550M		IV Y55M	4Y55 H5					

# AGENCY APPROVALS

NOTE: Approvals are updated periodically.

*Consult your Lincoln Electric representative for the latest Approval/Grade revisions.*

Product	AWS A5	ABS	CWB/CSA	DNV	Lloyd's Register	BV	AWS D1.8	ISO	JIS	TUV
<b>SAW</b>										
Lincolnweld 888 / Lincolnweld LA-85 (LNS 165)	F7P6-ENi5-Ni5-H4, F8A6-ENi5-Ni5-H4	5YQ500M H5		V Y50M H5	5Y50M H5					
Lincolnweld 888 / Lincolnweld LA-90	F9A6-EA3K-A3-H4		F62A5-EA3K-A3-H4							
Lincolnweld 888 / Lincolnweld LA-92 (LNS 150)	F8P2-EB2R-B2R									
Lincolnweld 888 / Lincolnweld LA-93 (LNS 151)	F9P2-EB3R-B3R									
Lincolnweld 888 / Lincolnweld LAC-690	F11A10-ECG-G-H4, F11P6-ECG-G-H4, F12A10-ECG-G-H4	5YQ690M H5	F11A10-ECG-G-H4	V Y69M H5	5Y69MH5					
Lincolnweld 888 / Lincolnweld LAC-B2	F8P4-ECB2-B2-H8									
Lincolnweld 888 / Lincolnweld L-S3 (LNS133U, L50M)	F7A8-EH12K-H4	4YQ420M		IV Y42M						
Lincolnweld 888								SA FB 1		
Lincolnweld 960 / Lincolnweld L-50	F7A2-EM13K-H4	F7A2-EM13K-H4								
Lincolnweld 960 / Lincolnweld L-56	F7A2-EH11K-H4						3/32", 1/8", 5/32"			
Lincolnweld 960 / Lincolnweld L-61	F6P4-EM12K, F7A2-EM12K-H8	F7A2-EM12K-H8	F49A3-EM12K-H8				1/8"			
Lincolnweld 960 / Lincolnweld LA-100	F10A4-EM2-G-H4									
Lincolnweld 960 / Lincolnweld LA-71	F7A2-EM14K-H4, F7P2-EM14K-H4									
Lincolnweld 960 / Lincolnweld LA-75	F7P6-ENi1K-Ni1-H4, F8A2-ENi1K-Ni1-H4		F55A3-ENi1K-Ni1-H4							
Lincolnweld 960 / Lincolnweld LA-85 (LNS 165)	F7P5-ENi5-G-H4, F8A2-ENi5-G-H4						3/32", 1/8", 5/32"			
Lincolnweld 960 / Lincolnweld LA-93 (LNS 151)	F9P0-EB3-G-H8									
Lincolnweld 960								SA AB 1		
Lincolnweld 980 / Lincolnweld L-50	F7A2-EM13K-H8		F49A3-EM13K-H8							
Lincolnweld 980 / Lincolnweld L-61	F7A2-EM12K-H8		F49A3-EM12K-H8							
Lincolnweld 980 / Lincolnweld LA-75	F7A2-ENi1K-Ni1-H8		F55A3-ENi1K-Ni1-H8							
Lincolnweld 980 / Lincolnweld LAC-Ni2	F8A2-ECNi2-Ni2-H8									
Lincolnweld 980 / Lincolnweld LC-72	F7A2-EC1-H8		F49A3-EC1-H8							
Lincolnweld 980								SA AB 1 SA AR 1		
Lincolnweld 995N / Lincolnweld Emergence 61	F6TA2-EM12K-H4									
Lincolnweld 995N / Lincolnweld Emergence 83	F8TA6-EG									
Lincolnweld 995N / Lincolnweld L-61	F7A4-EM12K-H4									

# AGENCY APPROVALS

NOTE: Approvals are updated periodically.

*Consult your Lincoln Electric representative for the latest Approval/Grade revisions.*

Product	AWS A5	ABS	CWB/CSA	DNV	Lloyd's Register	BV	AWS D1.8	ISO	JIS	TUV
<b>SAW</b>										
Lincolnweld 995N / Lincolnweld L-70	F8A2-EA1-A4									
Lincolnweld 995N / Lincolnweld LA-81 (LNS 140TB)	F9A2-EG-G-H4									
Lincolnweld 995N / Lincolnweld LA-90	F9A2-EA3K-G-H8									
Lincolnweld 995N								SA AB 1		
Lincolnweld 998N / Lincolnweld Emergence 61	F7TA2-EM12K									
Lincolnweld 998N / Lincolnweld Emergence 70	F8TA2-EA1									
Lincolnweld 998N / Lincolnweld Emergence 83	F8TA6-EG									
Lincolnweld 998N								SA AB 1		
Lincolnweld A-XXX-10 / Lincolnweld L-61	F7A4-EM12K-Ni1-H8		F49A4-EM12K-Ni1-H8							
Lincolnweld A-XXX-10								SA Z 1		
Lincolnweld MIL800-H / Lincolnweld LA-100	F9P4-EM2-M2-H2, F10A6-EM2-M2-H2									
Lincolnweld MIL800-H / Lincolnweld LA-71	F7A6-EM14K-H2, F7P6-EM14K-H2									
Lincolnweld MIL800-H / Lincolnweld LA-75	F7A8-ENi1K-Ni1-H2									
Lincolnweld MIL800-H / Lincolnweld LA-81 (LNS 140TB)	F9TA4G-EG									
Lincolnweld MIL800-H / Lincolnweld LA-84 (LNS 164)	F10A6-EF3-F3-H2, F9P6-EF3-F3-H2									
Lincolnweld MIL800-H / Lincolnweld LA-85 (LNS 165)	F8A8-ENi5-Ni5-H2, F8P8-ENi5-Ni5-H2									
Lincolnweld MIL800-H / Lincolnweld LA-90	F9A6-EA3K-A3-H2, F9P6-EA3K-A3-H2									
Lincolnweld MIL800-H / Lincolnweld LA-92 (LNS 150)	F8P2-EB2-B2-H2									
Lincolnweld MIL800-H / Lincolnweld LA-93 (LNS 151)	F9P2-EB3R-B3R-H2									
Lincolnweld MIL800-H / Lincolnweld LAC-690	F11A6-ECG-G-H4									
Lincolnweld MIL800-H / Lincolnweld LAC-Ni2	F8A10-ECNi2-Ni2-H8									
Lincolnweld MIL800-H / Lincolnweld L-53 (LNS133U,L50M)	F7A8-EH12K-H2, F7P8-EH12K-H2									
Lincolnweld MIL800-H								SA FB 1		
Lincolnweld MIL800-HPNi / Lincolnweld LA-100	F11A4-EM2-G-H2									

# AGENCY APPROVALS

NOTE: Approvals are updated periodically.

*Consult your Lincoln Electric representative for the latest Approval/Grade revisions.*

Product	AWS A5	ABS	CWB/CSA	DNV	Lloyd's Register	BV	AWS D1.8	ISO	JIS	TUV
<b>SAW</b>										
Lincolnweld MIL800-HPNi / Lincolnweld LA-75	F8A6-ENi1K-G-H2									
Lincolnweld MIL800-HPNi / Lincolnweld LA-85 (LNS 165)	F9A4-ENi5-G-H2		F62A4-ENi5-G-H2							
Lincolnweld MIL800-HPNi								SA FB 1		
Lincolnweld P2000								SA AF 2		
Lincolnweld P2007								SA AAS 2		
Lincolnweld P223 / Lincolnweld L-56	F7A6-EH11K-H8, F7P6-EH11K-H8									
Lincolnweld P223 / Lincolnweld L-61	F7A4-EM12K-H8									
Lincolnweld P223 / Lincolnweld LA-71	F7A4-EM14K-H8, F7P6-EM14K-H8									
Lincolnweld P223 / Lincolnweld LA-81 (LNS 140TB)	F8TA4G-EG									
Lincolnweld P223 / Lincolnweld LA-90	F9TA2G-EA3K, F9TA4G-EA3K, F9A0-EA3K-G									
Lincolnweld P223 / Lincolnweld L-S3 (LNS133U,L50M)	F7P8-EH12K-H8, F7A8-EH12K-H8		F49A6-EH12K-H8							
Lincolnweld SPX80 / Lincolnweld L-61	F7A5-EM12K-H8									
Lincolnweld SPX80 / Lincolnweld L-70	F8A4-EA1-A4-H8									
Lincolnweld SPX80 / Lincolnweld LA-75	F7TA0-ENi1K									
Lincolnweld SPX80 / Lincolnweld LA-85 (LNS 165)	F9A4-ENi5									
Lincolnweld SPX80 / Lincolnweld LA-90	F9A4-EA3K-G-H8									
Lincolnweld SPX80 / Lincolnweld L-S3 (LNS133U,L50M)	F7TA4-EH12K									
Lincolnweld SPX80								SA AB 1		
Lincolnweld SPX80N / Lincolnweld L-61	F8TA0G-EM12K									
Lincolnweld SPX80N / Lincolnweld L-70	F9TA4G-EA1									
Lincolnweld SPX80N / Lincolnweld LA-81 (LNS 140TB)	F9TA6G-EA2TiB									
Lincolnweld SPX80N / Lincolnweld LA-90	F9TA6G-EA3K									
Lincolnweld SPX80N / Lincolnweld L-S3 (LNS133U,L50M)	F8TA2G-EH12K									
Lincolnweld WTX / Lincolnweld L-61	F6P8-EM12K-H8, F7A8-EM12K-H8		F49A6-EM12K-H8							
Lincolnweld WTX / Lincolnweld L-70	F8A4-EA1-A3-H8									

# AGENCY APPROVALS

NOTE: Approvals are updated periodically.

*Consult your Lincoln Electric representative for the latest Approval/Grade revisions.*

Product	AWS A5	ABS	CWB/CSA	DNV	Lloyd's Register	BV	AWS D1.8	ISO	JIS	TUV
<b>SAW</b>										
Lincolnweld WTX / Lincolnweld LA-71	F7A6-EM14K-H8									
Lincolnweld WTX / Lincolnweld LA-75	F7A4-ENi1K-G-H8		F49A4-ENi1K-G-H8							
Lincolnweld WTX								S A AB 1		
Lincolnweld WTX-TR / Lincolnweld L-56	F8TA4-EH11K-H8		F55TA4-EH11K-H8 F62A4-EH11K-G-H8							
Lincolnweld WTX-TR / Lincolnweld L-61	F7TA4-EM12K-H8, F7A6-EM12K-H8		F49A5-EM12K-H8							
Lincolnweld WTX-TR / Lincolnweld L-70	F8TA4-EA1-H8									
Lincolnweld WTX-TR / Lincolnweld LA-75	F8TA0-ENi1K									
Lincolnweld 2209	ER2209	ER2209								
Lincolnweld 2594	ER2594	ER2594								
Lincolnweld 308/308H	ER308 ER308H									
Lincolnweld 308/308L	ER308 ER308L	ER308 ER308L	ER308 ER308L					SS308L		
Lincolnweld 308/308LCF	ER308 ER308L									
Lincolnweld 309/309L	ER309 ER309L	ER309 ER309L	ER309 ER309L					SS309L		
Lincolnweld 309LMo								23 12 2 L		
Lincolnweld 310	ER310	ER310								
Lincolnweld 316/316L	ER316 ER316L	ER316 ER316L	ER316 ER316L					SS316L		
Lincolnweld 316/316LCF	ER316 ER316L									
Lincolnweld 317/317L	ER317 ER317L									
Lincolnweld 320LR	ER320LR									
Lincolnweld 347	ER347	ER347								
Lincolnweld 385	ER385									
Lincolnweld 410NiMo	ER410NiMo									
Lincolnweld 630	ER630									
Lincolnweld Emergence 60	EL12							S1		
Lincolnweld Emergence 61	EM12K							S2Si		
Lincolnweld Emergence 70	EA1									
Lincolnweld Emergence 73	EG									
Lincolnweld Emergence 74	EA2							S2Mo		

# AGENCY APPROVALS

NOTE: Approvals are updated periodically.

*Consult your Lincoln Electric representative for the latest Approval/Grade revisions.*

Product	AWS A5	ABS	CWB/CSA	DNV	Lloyd's Register	BV	AWS D1.8	ISO	JIS	TUV
<b>SMAW</b>										
Lincolnweld Emergence 83	EG							SZ		
Lincolnweld Emergence 90	EA3K									
Lincolnweld L-50	EM13K							SU25		
Lincolnweld L-56	ER70S-6							SU31		
Lincolnweld L-60	EL12							S1		
Lincolnweld L-61	EM12K							S2Si		
Lincolnweld L-70	EA1							S2Mo		
Lincolnweld LA-100	EM2							SZ		
Lincolnweld LA-71	EM14K							SU24		
Lincolnweld LA-75	ENi1K							SUN21		
Lincolnweld LA-81 (LNS 140TB)	EA2TiB							SZ		
Lincolnweld LA-84 (LNS 164)	EF3							S3Ni1Mo		
Lincolnweld LA-85 (LNS 165)	ENi5							SZ		
Lincolnweld LA-90	EA3K							SZ		
Lincolnweld LA-92 (LNS 150)	EB2R							S S CrMo1		
Lincolnweld LA-93 (LNS 151)	EB3R							S S CrMo2		
Lincolnweld L-53 (LNS133U,L50M)	EH12K							S3Si		
OP 121TT / Lincolnweld LA-84 (LNS 164)	F9A8-EF3-F3-H8, F9P8-EF3-F3-H8									

<b>SMAW</b>										
Excalibur 10018-D2 MR	E10018-D2 H4R	3YQ620 H5	E6918-D2	3 Y62H5	3Y62M H5					
Excalibur 11018M MR	E11018M-H4R	4YQ690 H5, E11018M-H4R	E11018M-H4R	4 YM69H5						
Excalibur 308/308H-16	E308-16, E308H-16	E308-16, E308H-16	E308-16, E308H-16							
Excalibur 308/308L-15	E308-15, E308L-15	E308-15, E308L-15								
Excalibur 308/308L-17	E308-17, E308L-17	E308-17, E308L-17	E308-17, E308L-17							
Excalibur 308L-16	E308L-16	E308L-16	E308L-16							
Excalibur 309/309L-15	E309-15, E309L-15	E309-15, E309L-15								
Excalibur 309/309L-16	E309-16, E309L-16	E309-16, E309L-16	E309-16, E309L-16							
Excalibur 309/309L-17	E309-17, E309L-17	E309-17, E309L-17	E309-17, E309L-17							

# AGENCY APPROVALS

NOTE: Approvals are updated periodically.

*Consult your Lincoln Electric representative for the latest Approval/Grade revisions.*

Product	AWS A5	ABS	CWB/CSA	DNV	Lloyd's Register	BV	AWS D1.8	ISO	JIS	TUV
<b>SMAW</b>										
Excalibur 316/316L-15	E316-15, E316L-15	E316-15, E316L-15	E316-15, E316L-15							
Excalibur 316/316L-16	E316-16, E316L-16	E316-16, E316L-16	E316-16, E316L-16							
Excalibur 316/316L-17	E316-17, E316L-17	E316-17, E316L-17	E316-17, E316L-17							
Excalibur 7018 MR	E7018 H4R	3YH5	E4918	3YH5	3YM H5	3YHHH		E4918 A H5		
Excalibur 7018 MR N	E7018 H4R, E7018-1 H4R		E4918-H4R							
Excalibur 7018-1 MR	E7018, E7018-1 H4R	3YH5	E4918-1-H4R	3YH5	3YM H5	3YHHH		E 42 4 Z B 3 2 H5 E4918-1 A U H5		
Excalibur 7018-A1 MR	E7018-A1, E7018-A1 H4R	E7018-A1 H4R	E4918-A1-H4R							
Excalibur 7018M MR	E7018-1 H4R	3YH5								
Excalibur 7028	E7028-H8	3YH10	E4928-H8	3YH10	3YM H10					
Excalibur 8018-B2 MR	E8018-B2, E8018-B2 H4R		E5518-B2							
Excalibur 8018-C1 MR	E8018-C1 H4R		E5518-C1-H4							
Excalibur 8018-C3 MR	E8018-C3 H4R	E8018-C3 H4R	E5518-C3-H4					E5518-N2 A U H5		
Excalibur 9018-B3 MR	E9018-B3, E9018-B3 H4R		E6218-B3							
Excalibur 9018-G MR N	E9018-G H4R									
Excalibur 9018M MR	E9018M, E9018M H4R	E9018M H4R	E6218M-H4R, E9018M H4R							
Ferroweld	E5t									
Fleetweld 180	E6011		E4311							
Fleetweld 22	E6022									
Fleetweld 35	E6011	E6011			3M			E4311 A		
Fleetweld 35+	E6011		E4311							
Fleetweld 35LS	E6011	E6011								
Fleetweld 37	E6013	E6013	E4313	1	1M	1		E4313 A		
Fleetweld 37+	E6013		E4313							
Fleetweld 47	E7014	E7014	E4914	1	1M	1				
Fleetweld 5P	E6010	E6010	E4310		3M					
Fleetweld 5P+	E6010	E6010	E4310	3						
Jet-LH 78 MR	E7018, E7018 H4R	E7018	E4918-1	3YH5	3YM H5	3YHHH				

# AGENCY APPROVALS

NOTE: Approvals are updated periodically.

*Consult your Lincoln Electric representative for the latest Approval/Grade revisions.*

Product	AWS A5	ABS	CWB/CSA	DNV	Lloyd's Register	BV	AWS D1.8	ISO	JIS	TUV
<b>SMAW</b>										
Jetweld 1	E7024-1	E7024-1	E4924-1	1	1M	1		E4924-1 A		
Jetweld 2	E6027	E6027	E4327	3	3M	3		E4327 A		
Jetweld LH-70	E7018, E7018 H4R	3YH10, E7018	E4918-1	3 Y40H5	3YM H5	3YHHH				
Lincoln 6013	E6013									
Lincoln 7014	E7014									
Lincoln 7018 AC	E7018, E7018-H8		E4918-H8							
Millennium Arc 7018-1	E7018, E7018-1 H4R	3YH5	E4918-1-H4R	3YH5	3YM H5					
Pipelinex 16P	E7016-1 H4, E7016-H4	E7016-H4	E4916-H4							
Pipelinex 19P	E10018-G-H4R									
Pipelinex 6P+	E6010	E6010	E4310	3				E 42 3 C 2 1		
Pipelinex 7P+	E7010-G, E7010-P1	E7010-P1						E 46 3 1Ni C 2 1		
Pipelinex 8P+	E8010-G, E8010-P1	E8010-P1	E5510-P1							
Pipelinex Arc 80	E8010-G, E8010-P1		E8010-P1							
Pipelinex LH-D100	E10045-P2 H4R		E10045-P2 H4R							
Pipelinex LH-D80	E8045-P2 H4R	E8045-P2 H4R	E8045-P2 H4R							
Pipelinex LH-D90	E9045-P2 H4R	E9045-P2 H4R	E9045-P2 H4R							
Shield-Arc 70+	E8010-G, E8010-P1	E8010-G	E5510-G							
Shield-Arc 85	E7010-A1	E7010-A1	E4910-A1							
Shield-Arc 90	E9010-G									
Shield-Arc HYP+	E7010-P1	E7010-P1	E4910-P1							
Tech-Rod Weld A	ENiCrFe-2									



# SAFETY GUIDELINES

## ⚠ WARNING ⚠

### ⚠ CALIFORNIA PROPOSITION 65 WARNINGS ⚠

#### FOR DIESEL ENGINES

Diesel engine exhaust and some of its constituents are known to the State of California to cause cancer, birth defects, and other reproductive harm.

#### FOR GASOLINE ENGINES

The engine exhaust from this product contains chemicals known to the State of California to cause cancer, birth defects, or other reproductive harm.

**ARC WELDING CAN BE HAZARDOUS. PROTECT YOURSELF AND OTHERS FROM POSSIBLE SERIOUS INJURY OR DEATH. KEEP CHILDREN AWAY. PACEMAKER WEARERS SHOULD CONSULT WITH THEIR DOCTOR BEFORE OPERATING.**

Read and understand the following safety highlights. For additional safety information, it is strongly recommended that you purchase a copy of "Safety in Welding & Cutting - ANSI Standard Z49.1" from the American Welding Society, P.O. Box 351040, Miami, Florida 33135 or CSA Standard W117.2-1974. A Free copy of "Arc Welding Safety" booklet E205 is available from the Lincoln Electric Company, 22801 St. Clair Avenue, Cleveland, Ohio 44117-1199.

**BE SURE THAT ALL INSTALLATION, OPERATION, MAINTENANCE AND REPAIR PROCEDURES ARE PERFORMED ONLY BY QUALIFIED INDIVIDUALS.**

## ⚠ FOR ENGINE POWERED EQUIPMENT. ⚠

1.a. Turn the engine off before troubleshooting and maintenance work unless the maintenance work requires it to be running.

1.b. Operate engines in open, well-ventilated areas or vent the engine exhaust fumes outdoors.

1.c. Do not add the fuel near an open flame welding arc or when the engine is running. Stop the engine and allow it to cool before refueling to prevent spilled fuel from vaporizing on contact with hot engine parts and igniting. Do not spill fuel when filling tank. If fuel is spilled, wipe it up and do not start engine until fumes have been eliminated.

1.d. Keep all equipment safety guards, covers and devices in position and in good repair. Keep hands, hair, clothing and tools away from V-belts, gears, fans and all other moving parts when starting, operating or repairing equipment.



1.e. In some cases it may be necessary to remove safety guards to perform required maintenance. Remove guards only when necessary and replace them when the maintenance requiring their removal is complete. Always use the greatest care when working near moving parts.

1.f. Do not put your hands near the engine fan. Do not attempt to override the governor or idler by pushing on the throttle control rods while the engine is running.



1.g. To prevent accidentally starting gasoline engines while turning the engine or welding generator during maintenance work, disconnect the spark plug wires, distributor cap or magneto wire as appropriate.

1.h. To avoid scalding, do not remove the radiator pressure cap when the engine is hot.



REFER TO [HTTP://WWW.LINCOLNELECTRIC.COM/SAFETY](http://www.lincolnelectric.com/safety) FOR ADDITIONAL SAFETY INFORMATION.

# SAFETY GUIDELINES

## ELECTRIC AND MAGNETIC FIELDS MAY BE DANGEROUS

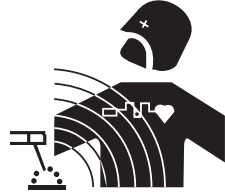

- 2.a. Electric current flowing through any conductor causes localized Electric and Magnetic Fields (EMF). Welding current creates EMF fields around welding cables and welding machines
- 2.b. EMF fields may interfere with some pacemakers, and welders having a pacemaker should consult their physician before welding.
- 2.c. Exposure to EMF fields in welding may have other health effects which are now not known.
- 2.d. All welders should use the following procedures in order to minimize exposure to EMF fields from the welding circuit:
  - 2.d.1. Route the electrode and work cables together - Secure them with tape when possible.
  - 2.d.2. Never coil the electrode lead around your body.
  - 2.d.3. Do not place your body between the electrode and work cables. If the electrode cable is on your right side, the work cable should also be on your right side.
  - 2.d.4. Connect the work cable to the workpiece as close as possible to the area being welded.
  - 2.d.5. Do not work next to welding power source.

## ELECTRIC SHOCK CAN KILL



- 3.a. The electrode and work (or ground) circuits are electrically “hot” when the welder is on. Do not touch these “hot” parts with your bare skin or wet clothing. Wear dry, hole-free gloves to insulate hands.
- 3.b. Insulate yourself from work and ground using dry insulation. Make certain the insulation is large enough to cover your full area of physical contact with work and ground. In addition to the normal safety precautions, if welding must be performed under electrically hazardous conditions (in damp locations or while wearing wet clothing; on metal structures such as floors, gratings or scaffolds; when in cramped positions such as sitting, kneeling or lying, if there is a high risk of unavoidable or accidental contact with the workpiece or ground) use the following equipment:
  - Semiautomatic DC Constant Voltage (Wire) Welder.
  - DC Manual (Stick) Welder.
  - AC Welder with Reduced Voltage Control.
- 3.c. In semiautomatic or automatic wire welding, the electrode, electrode reel, welding head, nozzle or semiautomatic welding gun are also electrically “hot”.
- 3.d. Always be sure the work cable makes a good electrical connection with the metal being welded. The connection should be as close as possible to the area being welded.
- 3.e. Ground the work or metal to be welded to a good electrical (earth) ground.
- 3.f. Maintain the electrode holder, work clamp, welding cable and welding machine in good, safe operating condition. Replace damaged insulation.
- 3.g. Never dip the electrode in water for cooling.
- 3.h. Never simultaneously touch electrically “hot” parts of electrode holders connected to two welders because voltage between the two can be the total of the open circuit voltage of both welders.
- 3.i. When working above floor level, use a safety belt to protect yourself from a fall should you get a shock.
- 3.j. Also see Items 6.c. and 8.

REFER TO [HTTP://WWW.LINCOLNELECTRIC.COM/SAFETY](http://www.lincolnelectric.com/safety) FOR ADDITIONAL SAFETY INFORMATION.

# SAFETY GUIDELINES

## ARC RAYS CAN BURN

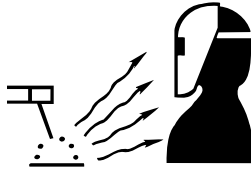

4.a. Use a shield with the proper filter and cover plates to protect your eyes from sparks and the rays of the arc when welding or observing open arc welding. Headshield and filter lens should conform to ANSI Z87.1 standards.

4.b. Use suitable clothing made from durable flame-resistant material to protect your skin and that of your helpers from the arc rays.

4.c. Protect other nearby personnel with suitable, non-flammable screening and/or warn them not to watch the arc nor expose themselves to the arc rays or to hot spatter or metal.

## FUMES AND GASES CAN BE DANGEROUS

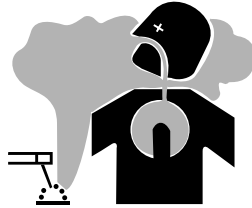

5.a. Welding may produce fumes and gases hazardous to health. Avoid breathing these fumes and gases. When welding, keep your head out of the fume. Use enough ventilation and/or exhaust at the arc to keep fumes and gases away from the breathing zone. When welding with electrodes which require special ventilation such as stainless or hard facing (see instructions on container or MSDS) or on lead or cadmium plated steel and other metals or coatings which produce highly toxic fumes, keep exposure as low as possible and within applicable OSHA PEL and ACGIH TLV limits using local exhaust or mechanical ventilation. In confined spaces or in some circumstances, outdoors, a respirator may be required. Additional precautions are also required when welding on galvanized steel.

5.b. The operation of welding fume control equipment is affected by various factors including proper use and positioning of the equipment, maintenance of the equipment and the specific welding procedure and application involved. Worker exposure level should be checked upon installation and periodically thereafter to be certain it is within applicable OSHA PEL and ACGIH TLV limits.

5.c. Do not weld in locations near chlorinated hydrocarbon vapors coming from degreasing, cleaning or spraying operations. The heat and rays of the arc can react with solvent vapors to form phosgene, a highly toxic gas, and other irritating products.

5.d. Shielding gases used for arc welding can displace air and cause injury or death. Always use enough ventilation, especially in confined areas, to insure breathing air is safe.

5.e. Read and understand the manufacturer's instructions for this equipment and the consumables to be used, including the materialsafety data sheet (MSDS) and follow your employer's safety practices. MSDS forms are available from your welding distributor or from the manufacturer.

5.f. Also see item 1.b.

REFER TO [HTTP://WWW.LINCOLNELECTRIC.COM/SAFETY](http://www.lincolnelectric.com/safety) FOR ADDITIONAL SAFETY INFORMATION.

# SAFETY GUIDELINES

## WELDING AND CUTTING SPARKS CAN CAUSE FIRE OR EXPLOSION

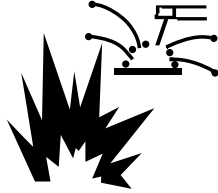

- 6.a. Remove fire hazards from the welding area. If this is not possible, cover them to prevent the welding spark from starting a fire. Remember that welding sparks and hot materials from welding can easily go through small cracks and openings to adjacent areas. Avoid welding near hydraulic lines. Have a fire extinguisher readily available.
- 6.b. Where compressed gases are to be used at the job site, special precautions should be used to prevent hazardous situations. Refer to "Safety in Welding and Cutting" (ANSI Standard Z49.1) and the operating information for the equipment being used.
- 6.c. When not welding, make certain no part of the electrode circuit is touching the work or ground. Accidental contact can cause overheating and create a fire hazard.
- 6.d. Do not heat, cut or weld tanks, drums or containers until the proper steps have been taken to insure that such procedures will not cause flammable or toxic vapors from substances inside. They can cause an explosion even though they have been "cleaned". For information, purchase "Recommended Safe Practices for the Preparation for Welding and Cutting of Containers and Piping That Have Held Hazardous Substances", AWS F4.1 from the American Welding Society (see address above).
- 6.e. Vent hollow castings or containers before heating, cutting or welding. They may explode.
- 6.f. Sparks and spatter are thrown from the welding arc. Wear oil free protective garments such as leather gloves, heavy shirt, cuffless trousers, high shoes and a cap over your hair. Wear ear plugs when welding out of position or in confined places. Always wear safety glasses with side shields when in a welding area.
- 6.g. Connect the work cable to the work as close to the welding area as practical. Work cables connected to the building framework or other locations away from the welding area increase the possibility of the welding current passing through lifting chains, crane cables or other alternate circuits. This can create fire hazards or overheat lifting chains or cables until they fail.
- 6.h. Also see item 1.c.
- 6.i. Read and follow NFPA 51B "Standard for Fire Prevention During Welding, Cutting and Other Hot Work", available from NFPA, 1 Batterymarch Park, PO box 9101, Quincy, Ma 022690-9101.
- 6.j. Do not use a welding power source for pipe thawing.

REFER TO [HTTP://WWW.LINCOLNELECTRIC.COM/SAFETY](http://www.lincolnelectric.com/safety) FOR ADDITIONAL SAFETY INFORMATION.

# SAFETY GUIDELINES

## CYLINDER MAY EXPLODE IF DAMAGED

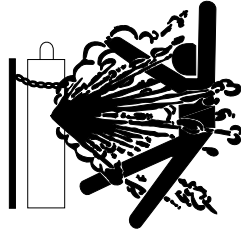

- 7.a. Use only compressed gas cylinders containing the correct shielding gas for the process used and properly operating regulators designed for the gas and pressure used. All hoses, fittings, etc. should be suitable for the application and maintained in good condition.
- 7.b. Always keep cylinders in an upright position securely chained to an undercarriage or fixed support.
- 7.c. Cylinders should be located:
  - Away from areas where they may be struck or subjected to physical damage.
  - A safe distance from arc welding or cutting operations and any other source of heat, sparks, or flame.
- 7.d. Never allow the electrode, electrode holder or any other electrically "hot" parts to touch a cylinder.
- 7.e. Keep your head and face away from the cylinder valve outlet when opening the cylinder valve.
- 7.f. Valve protection caps should always be in place and hand tight except when the cylinder is in use or connected for use.
- 7.g. Read and follow the instructions on compressed gas cylinders, associated equipment, and CGA publication P-1, "Precautions for Safe Handling of Compressed Gases in Cylinders," available from the Compressed Gas Association 1235 Jefferson Davis Highway, Arlington, VA 22202.

## FOR ELECTRICALLY POWERED EQUIPMENT



- 8.a. Turn off input power using the disconnect switch at the fuse box before working on the equipment.
- 8.b. Install equipment in accordance with the U.S. National Electrical Code, all local codes and the manufacturer's recommendations.
- 8.c. Ground the equipment in accordance with the U.S. National Electrical Code and the manufacturer's recommendations.

REFER TO [HTTP://WWW.LINCOLNELECTRIC.COM/SAFETY](http://www.lincolnelectric.com/safety) FOR ADDITIONAL SAFETY INFORMATION.

# SAFETY GUIDELINES

## Safety Practices in Welding

### ⚠ WARNING ⚠

## FUMES AND GASES CAN BE DANGEROUS TO YOUR HEALTH

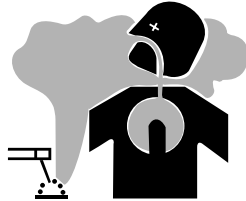

- *Keep fumes and gases from your breathing zone and general area.*
- *Keep your head out of the fumes.*
- *Use enough ventilation or exhaust at the arc, or both, to keep fumes and gases from your breathing zone and general area.*

### *Fumes and Gases*

Because of the variables involved in fume and gas generation from arc welding, cutting and allied processes (such as the welding process and electrode, the base metal, coatings on the base metal, and other possible contaminants in the air), we'll have to treat the subject in a rather general way, lumping all but the more hazardous situations together. The precautions we describe will hold true for all arc welding processes.

The **fume plume** contains solid particles from the consumables, base metal, and base metal coating. For common mild steel arc welding, depending on the amount and length of exposure to these fumes, most immediate or short term effects are temporary, and include symptoms of burning eyes and skin, dizziness, nausea, and fever. For example, zinc fumes can cause metal fume fever, a temporary illness that is similar to the flu.

Long-term exposure to welding fumes can lead to siderosis (iron deposits in the lungs) and may affect pulmonary function. Bronchitis and some lung fibrosis have been reported.

Some consumables contain certain compounds in amounts which may require special ventilation and/or exhaust. These Special Ventilation products can be identified by reading the labels on the package. If Special Ventilation products are used indoors, use local exhaust. If Special Ventilation products are used outdoors, a respirator may be required. Various compounds, some of which may be in welding fume, and reported health effects, in summary, are:

**Barium:** Soluble barium compounds may cause severe stomach pain, slow pulse rate, irregular heart beat, ringing of the ears, convulsions and muscle spasms. In extreme cases can cause death.

**Cadmium:** Cadmium also requires extra precautions. This toxic metal can be found on some steel and steel fasteners as a plating, or in silver solder. Cadmium fumes can be fatal even under brief overexposures, with symptoms much like those of metal fume fever. These two conditions should not be confused. Overexposure to cadmium can be enough to cause fatalities, with symptoms appearing quickly, and, in some circumstances, death a few days later.

**Chromium:** Chromium is on the IARC (International Agency for Research on Cancer) and NTP (National Toxicology Program) lists chromium as posing a carcinogenic risk to humans. Fumes from the use of stainless steel, hardfacing and other types of consumables contain chromium and/or nickel. Some forms of these metals are known or suspected to cause lung cancer in processes other than welding and asthma has been reported. Therefore, it is recommended that precautions be taken to keep exposures as low as possible. OSHA recently adopted a lower PEL (Permissible Exposure Limit) for chromium (see Supplement 3). The use of local exhaust and/or an approved respirator may be required to avoid overexposure.

**Coatings** on the metal to be welded, such as paint, may also contain toxic substances, such as lead, chromium and zinc. In general, it is always best to remove coatings from the base metal before welding or cutting.

**Cobalt:** Exposure to cobalt can cause respiratory disease and pulmonary sensitization. Cobalt in metallic form has been reported to cause lung damage.

**Copper:** Prolonged exposure to copper fume may cause skin irritation or discoloration of the skin and hair.

**Manganese:** Manganese overexposure may affect the central nervous system, resulting in poor coordination, difficulty in speaking, and tremor of arms or legs. This condition is considered irreversible.

**Nickel:** Nickel and its compounds are on the IARC (International Agency for Research on Cancer) and NTP (National Toxicology Program) lists as posing a carcinogenic risk to humans.

**Silica:** Crystalline silica is present in respirable dust form submerged arc flux. Overexposure can cause severe lung damage (silicosis).

**Zinc:** Overexposure to zinc (from galvanized metals) may cause metal fume fever with symptoms similar to the common flu.

REFER TO [HTTP://WWW.LINCOLNELECTRIC.COM/SAFETY](http://www.lincolnelectric.com/safety) FOR ADDITIONAL SAFETY INFORMATION.

# SAFETY GUIDELINES

## Safety Practices in Welding

*The gases that result from an arc welding process also present potential hazard.*

Most of the shielding gases (argon, helium, and carbon dioxide) are non-toxic, but, as they are released, they **displace oxygen** in your breathing air, causing dizziness, unconsciousness, and death, the longer your brain is denied the oxygen it needs. Carbon monoxide can also be developed and may pose a hazard if excessive levels are present.

*The heat and UV radiation can cause irritation to the eyes and lungs.*

Some degreasing compounds such as trichlorethylene and perchlorethylene can decompose from the heat and ultraviolet radiation of an arc. Because of the chemical breakdown of vapor-degreasing materials under ultraviolet radiation, arc welding should not be done in the vicinity of a vapor-degreasing operation. Carbon-arc welding, gas tungsten-arc welding and gas metal arc welding should be especially avoided in such areas, because they emit more ultraviolet radiation than other processes. Also, keep in mind that ozone and nitrogen oxides are formed when UV radiation passes through the air. These gases cause headaches, chest pains, irritation of the eyes, and an itchiness in the nose and throat.

*There is one easy way to reduce the risk of exposure to hazardous fumes and gases: keep your head out of the fume plume!*

As obvious as this sounds, the failure to follow this advice is a common cause of fume and gas overexposure because the concentration of fume and gases is greatest in the plume. Keep fumes and gases from your breathing zone and general area using natural ventilation, mechanical ventilation, fixed or moveable exhaust hoods or local exhaust at the arc. Finally, it may be necessary to wear an approved respirator if adequate ventilation cannot be provided.

As a rule of thumb, for many mild steel electrode, if the air is visibly clear and you are comfortable, then the ventilation is generally adequate for your work. The most accurate way to determine if the worker exposure does not exceed the applicable exposure limit for compounds in the fumes and gases is to have an industrial hygienist take and analyze a sample of the air you are breathing. This is particularly important if you are welding with stainless, hardfacing or Special Ventilation products. All Lincoln MSDS have a maximum fume guideline number. If exposure to total fume is kept below that number, exposure to all fume from the electrode (not coatings or plating on the work) will be below the TLV.

There are also steps that you can take to identify hazardous substances in your welding environment. First, read the product label and material safety data sheet for the electrode posted in the work place or in the electrode or flux container to see what fumes can be reasonably expected from use of the product and to determine if special ventilation is needed. Secondly, know what the base metal is, and determine if there is any paint, plating, or coating that could expose you to toxic fumes and/or gases. Remove it from the metal being welded, if possible. If you start to feel uncomfortable, dizzy or nauseous, there is a possibility that you are being overexposed to fumes and gases, or suffering from oxygen deficiency. Stop welding and get some fresh air immediately. Notify your supervisor and co-workers so the situation can be corrected and other workers can avoid the hazard. Be sure you are following these safe practices, the consumable labeling and MSDS and improve the ventilation in your area. Do not continue welding until the situation has been corrected.

**NOTE: THE MSDS FOR ALL LINCOLN CONSUMABLES IS AVAILABLE ON LINCOLN'S WEBSITE: [WWW.LINCOLNELECTRIC.COM](http://WWW.LINCOLNELECTRIC.COM)**

Before we turn to the methods available to control welding fume exposure, you should understand a few basic terms:

**Natural Ventilation** is the movement of air through the workplace caused by natural forces. Outside, this is usually the wind. Inside, this may be the flow of air through open windows and doors.

**Mechanical Ventilation** is the movement of air through the workplace caused by an electrical device such as a portable fan or permanently mounted fan in the ceiling or wall.

**Source Extraction (Local Exhaust)** is a mechanical device used to capture welding fume at or near the arc and filter contaminants out of the air.

REFER TO [HTTP://WWW.LINCOLNELECTRIC.COM/SAFETY](http://WWW.LINCOLNELECTRIC.COM/SAFETY) FOR ADDITIONAL SAFETY INFORMATION.

# SAFETY GUIDELINES

## Safety Practices in Welding

The ventilation or exhaust needed for your application depends upon many factors such as:

- *Workspace volume*
- *Workspace configuration*
- *Number of welders*
- *Welding process and current*
- *Consumables used (mild steel, hardfacing, stainless, etc.)*
- *Allowable levels (TLV, PEL, etc.)*
- *Material welded (including paint or plating)*
- *Natural airflow*

Your work area has adequate ventilation when there is enough ventilation and/or exhaust to control worker exposure to hazardous materials in the welding fumes and gases so the applicable limits for those materials is not exceeded. See the MSDS for the legal limits, the OSHA PEL (Permissible Exposure Limit), and the recommended guideline, the ACGIH TLV (Threshold Limit Value), for many compounds found in welding fume.



REFER TO [HTTP://WWW.LINCOLNELECTRIC.COM/SAFETY](http://www.lincolnelectric.com/safety) FOR ADDITIONAL SAFETY INFORMATION.

### *Ventilation*

There are many methods which can be selected by the user to provide adequate ventilation for the specific application. The following section provides general information which may be helpful in evaluating what type of ventilation equipment may be suitable for your application. When ventilation equipment is installed, you should confirm worker exposure is controlled within applicable OSHA PEL and/or ACGIH TLV. According to OSHA regulations, when welding and cutting (mild steels), natural ventilation is usually considered sufficient to meet requirements, provided that:

1. **The room or welding area contains at least 10,000 cubic feet (about 22 in x 22 in x 22 in) for each welder.**
2. **The ceiling height is not less than 16 feet.**
3. **Cross ventilation is not blocked by partitions, equipment, or other structural barriers.**
4. **Welding is not done in a confined space.**

Spaces that do not meet these requirements should be equipped with mechanical ventilating equipment that exhausts at least 2000 CFM of air for each welder, except where local exhaust hoods or booths, or air-line respirators are used.

### **IMPORTANT SAFETY NOTE:**

When welding with electrodes which require special ventilation such as stainless or hardfacing (see instructions on container or MSDS) or on lead or cadmium plated steel and other metals or coatings which produce hazardous fumes, keep exposure as low as possible and below exposure limit values (PEL and TLV) for materials in the fume using local exhaust or mechanical ventilation. In confined spaces or in some circumstances, for example outdoors, a respirator may be required if exposure cannot be controlled to the PEL or TLV. (See MSDS) Additional precautions are also required when welding on galvanized steel.







**DON'T BE RESTRICTED  
BY DIFFUSIBLE  
HYDROGEN LIMITS!  
H4 CLASSIFIED FLUXES**



